

**KRPA Series Panel Plug-in Relay**

- 5 to 10A current capability
- Contact arrangements of 1, 2 and 3 form C (CO)
- Octal type termination for quick installation
- Indicator lamp available on certain models



Typical applications  
Baggage handling, lighting, inspection equipment, marine.

**Approvals**

UL E22575; CSA LR15734  
Technical data of approved types on request.

**Contact Data**

|                               |   |               |
|-------------------------------|---|---------------|
| Contact arrangement           | 1 form C (CO), 2 form C (CO), 3 form C (CO) |               |
| Rated voltage                 | 240VAC                                      |               |
| Rated current                 | 10A   |               |
| Contact material              | Ag  | AgCdO         |
| Min. recommended contact load | 100mA, 12VDC                                | 300mA, 12VDC  |
| Frequency of operation        | 360 ops./hour                               | 360 ops./hour |

**Contact ratings**

| Type                 | Load           | Cycles                  |
|----------------------|----------------|-------------------------|
| <b>UL 508</b>        |                |                         |
| KRPA, Ag             | 5A, 120VAC     | 100x10 <sup>3</sup>     |
|                      | 3A, 240VAC     | 100x10 <sup>3</sup>     |
|                      | 1/10HP, 120VAC | 1x10 <sup>3</sup>       |
|                      | 1/6HP, 240VAC  | 1x10 <sup>3</sup>       |
| KRPA, AgCdO          | 10A, 240VAC    | 100x10 <sup>3</sup>     |
|                      | 1/3HP, 120VAC  | 1x10 <sup>3</sup>       |
|                      | 1/2HP, 240VAC  | 1x10 <sup>3</sup>       |
| KA, Ag               | 5A, 120VAC     |                         |
|                      | 3A, 240VAC     |                         |
|                      | 1/10HP, 120VAC |                         |
|                      | 1/6HP, 240VAC  |                         |
| KA, AgCdO            | 10A, 120VAC    |                         |
|                      | 6A, 240VAC     |                         |
|                      | 1/6HP, 120VAC  |                         |
|                      | 1/3HP, 240VAC  |                         |
| Mechanical endurance |                | 10x10 <sup>6</sup> ops. |

**Coil Data**

|                                     |                            |
|-------------------------------------|----------------------------|
| Coil voltage range                  | 6 to 220VDC<br>6 to 240VAC |
| Coil insulation system according UL | Class B                    |

**Coil versions, DC coil**

| Coil code | Rated voltage VDC | Operate voltage VDC                             | Coil resistance Ω±10% | Rated coil power W |
|-----------|-------------------|---|-----------------------|--------------------|
| 6         | 6                 | 4.5   | 32                    | 1.15               |
| 12        | 12                | 9.0   | 120                   | 1.2                |
| 24        | 24                | 18.0  | 472                   | 1.25               |
| 48        | 48                | 36.0  | 1800                  | 1.3                |
| 110       | 110               | 82.5  | 10000                 | 1.2                |
| -         | 220               | Use 110V relay with 10KΩ, 5W resistor in series |                       |                    |

All figures are given for coil without preenergization, at ambient temperature +23°C.

**Coil Data (continued)**

**Coil versions, AC coil**

| Coil code | Rated voltage VAC | Operate voltage VAC | Coil resistance Ω±15% | Rated coil power VA |
|-----------|-------------------|---------------------|-----------------------|---------------------|
| 6         | 6                 | 5.1                 | 6                     | 2.01                |
| 12        | 12                | 10.2                | 24                    | 2.02                |
| 24        | 24                | 20.4                | 85                    | 2.02                |
| 120       | 120               | 102.0               | 2250                  | 2.1                 |
| 240       | 240               | 204.0               | 9110                  | 2.1                 |

All figures are given for coil without preenergization, at ambient temperature +23°C.

**Insulation Data**

|                               |  |                           |
|-------------------------------|--|---------------------------|
| Initial dielectric strength   |  |                           |
| between open contacts         |  | 1000V <sub>rms</sub>      |
| between contact and coil      |  | 1000V <sub>rms</sub>      |
| between adjacent contacts     |  | 1000V <sub>rms</sub>      |
| Initial insulation resistance |  |                           |
| between insulated elements    |  | KRPA: 1000MΩ<br>KA: 100MΩ |

**Other Data**

Material compliance: EU RoHS/ELV, China RoHS, REACH, Halogen content refer to the Product Compliance Support Center at [www.te.com/customer-support/rohssupportcenter](http://www.te.com/customer-support/rohssupportcenter)

|                                      |  |  |
|--------------------------------------|--|--|
| Ambient temperature                  |  |  |
| DC coil                              |  | KRPA: -45°C to 70°C<br>KA: -45°C to 85°C                   |
| AC coil                              |  | KRPA: -45°C to 55°C<br>KA: -45°C to 70°C                   |
| Category of environmental protection |  |  |
| IEC 61810                            |  | RT1 - dust protected KRPA and<br>RTO - open style KA       |
| Terminal type                        |  | KRPA: 8- or 11-pin octal-type plug<br>KA: solder terminals |
| Weight                               |  | 85g  |
| Packaging/unit                       |  | tray/25 pcs., box/150pcs.                                  |

**Accessories**

For details see datasheet      Sockets and Accessories, KRPA Relays

| Product Code | Description                                     |
|--------------|---|
| 27E891       | Two pole DIN socket (use 20C318 clip)           |
| 27E892       | Three pole DIN socket (use 20C318 clip)         |
| 27E122       | Two pole track mount socket (use 20C318 clip)   |
| 27E123       | Three pole track mount socket (use 20C318 clip) |

**KRPA Series Panel Plug-in Relay (Continued)**

**Dimensions**

KRPA



KA

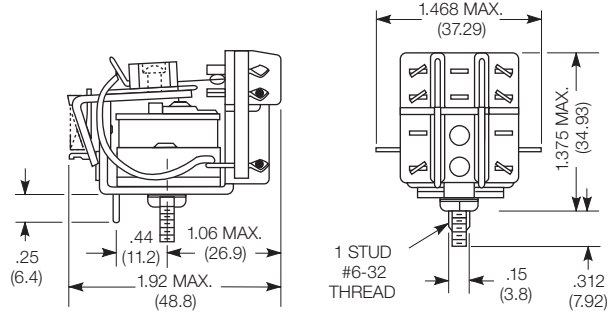

**Terminal assignment**

KRPA

1 form C

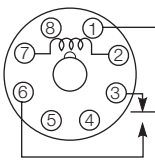

KRPA

2 form C

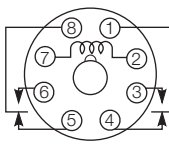

KRPA

3 form C

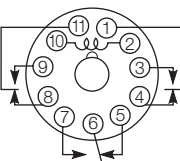

KA

1 form C

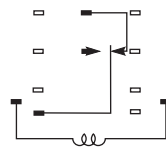

KA

2 form C

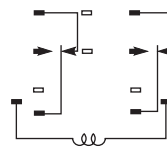

KA

3 form C

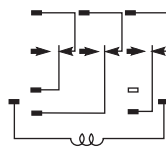

**Product code structure**

Typical product code

**KRPA -5 A Y -120**

**Type**

- KRPA** Enclosed relay with octal-style plug
- KA** Open style relay with solder terminals

**Contact arrangement and rating**

- 5** 1 form C (CO)
- 11** 2 form C (CO)
- 14** 3 form C (CO)

**Coil Input**

- A** AC, 50/60Hz
- D** DC

**Contact material and indicator lamp option**

- Y** Ag, no indicator lamp
- G** AgCdO, no indicator lamp
- N** AgCdO, with indicator (Code N only available with relay type KRPA)

**Options**

- Leave blank** no additional options
- F** Au flashed contacts (Options F and P only available with relay type KRPA)
- P** Push to test button

**Coil voltage**

Coil code: please refer to coil versions table

**KRPA Series Panel Plug-in Relay** (Continued)

| Product Code  | Arrangement    | Contact Material | Coil      | Option      | Part Number |             |             |
|---------------|----------------|------------------|-----------|-------------|-------------|-------------|-------------|
| KA-5AG-120    | 1 form C, 1 CO | AgCdO            | 120VAC    | Open style  | 7-1393099-1 |             |             |
| KA-5AY-120    |                | Ag               |           |             | 7-1393099-3 |             |             |
| KA-5DG-6      |                | AgCdO            |           |             | 6VDC        | 7-1393099-9 |             |
| KA-5DG-12     |                |                  |           |             | 12VDC       | 7-1393099-7 |             |
| KA-5DG-110    | 2 form C, 2 CO |                  | 110VDC    |             | 7-1393099-6 |             |             |
| KA-11AG-120   |                |                  | 120VAC    |             | 3-1393099-6 |             |             |
| KA-11AY-6     |                | Ag               | 6VAC      |             | 4-1393099-1 |             |             |
| KA-11AY-24    |                |                  | 24VAC     |             | 4-1393099-0 |             |             |
| KA-11AY-120   |                |                  | 120VAC    |             | 3-1393099-9 |             |             |
| KA-11DG-12    |                | AgCdO            | 12VDC     |             | 4-1393099-3 |             |             |
| KA-11DG-24    |                |                  | 24VDC     |             | 4-1393099-5 |             |             |
| KA-11DG-110   |                |                  | 110VDC    |             | 4-1393099-2 |             |             |
| KA-14AG-120   |                | 3 form C, 3 CO   |           | 120VAC      |             | 5-1393099-0 |             |
| KA-14AY-120   |                |                  | Ag        |             |             | 5-1393099-4 |             |
| KA-14DG-24    | AgCdO          |                  | 24VDC     |             | 5-1393099-7 |             |             |
| KA-14DG-110   |                |                  | 110VDC    |             | 5-1393099-5 |             |             |
| KRPA-5AG-24   | 1 form C, 1 CO |                  |           | 24VAC       | None        | 9-1393104-9 |             |
| KRPA-5AG-120  |                |                  |           | 120VAC      |             | 9-1393104-8 |             |
| KRPA-5DG-6    |                |                  | 6VDC      | 1393105-5   |             |             |             |
| KRPA-5DG-12   |                |                  | 12VDC     | 1393105-3   |             |             |             |
| KRPA-5DG-24   |                |                  | 24VDC     | 1393105-4   |             |             |             |
| KRPA-5DY-12   |                | Ag               | 12VDC     |             |             | 1393105-6   |             |
| KRPA-5DY-24   |                |                  | 24VDC     |             |             | 1393105-7   |             |
| KRPA-11AG-6   |                | 2 form C, 2 CO   | AgCdO     | 6VAC        |             |             | 2-1393104-8 |
| KRPA-11AG-12  |                |                  |           | 12VAC       |             |             | 2-1393104-4 |
| KRPA-11AG-24  |                |                  |           | 24VAC       |             |             | 1-1393105-2 |
| KRPA-11AG-120 |                |                  | 120VAC    |             | 2-1393104-5 |             |             |
| KRPA-11AG-240 |                |                  | 240VAC    |             | 2-1393104-7 |             |             |
| KRPA-11AN-12  |                |                  | 12VAC     | Indicator   | 3-1393104-1 |             |             |
| KRPA-11AN-24  |                |                  | 24VAC     |             | 3-1393104-3 |             |             |
| KRPA-11AN-120 |                |                  | 120VAC    |             | 3-1393104-2 |             |             |
| KRPA-11AN-240 |                |                  | 240VAC    |             | 3-1393104-4 |             |             |
| KRPA-11AY-6   | Ag             |                  | AgCdO     | 6VAC        | None        | 3-1393104-9 |             |
| KRPA-11AY-12  |                | 12VAC            |           | 3-1393104-5 |             |             |             |
| KRPA-11AY-24  |                | 24VAC            |           | 3-1393104-7 |             |             |             |
| KRPA-11AY-120 |                | 120VAC           |           | 3-1393104-6 |             |             |             |
| KRPA-11AY-240 |                | 240VAC           |           | 3-1393104-8 |             |             |             |
| KRPA-11DG-6   |                |                  |           | 6VDC        |             |             | 4-1393104-7 |
| KRPA-11DG-12  |                |                  |           | 12VDC       |             |             | 4-1393104-3 |
| KRPA-11DG-24  |                |                  |           | 24VDC       |             |             | 4-1393104-5 |
| KRPA-11DG-48  |                |                  |           | 48VDC       |             |             | 4-1393104-6 |
| KRPA-11DG-110 |                |                  |           | 110VDC      |             |             | 4-1393104-2 |
| KRPA-11DG-125 |                | 125VDC           |           | 4-1393104-4 |             |             |             |
| KRPA-11DG-24  |                | 24VDC            |           | 4-1393104-5 |             |             |             |
| KRPA-11DG-48  |                | 48VDC            |           | 4-1393104-6 |             |             |             |
| KRPA-11DN-12  |                | 12VDC            | Indicator | 5-1393104-0 |             |             |             |
| KRPA-11DN-24  |                | 24VDC            |           | 5-1393104-1 |             |             |             |
| KRPA-11DN-110 |                | 110VDC           |           | 4-1393104-9 |             |             |             |
| KRPA-11DY-12  | Ag             | AgCdO            | 12VDC     | None        | 5-1393104-6 |             |             |
| KRPA-11DY-24  |                |                  | 24VDC     |             | 5-1393104-7 |             |             |
| KRPA-14AG-12  | 3 form C, 3 CO | AgCdO            | 12VAC     |             | 6-1393104-4 |             |             |
| KRPA-14AG-24  |                |                  | 24VAC     |             | 6-1393104-7 |             |             |
| KRPA-14AG-120 |                |                  | 120VAC    |             | 6-1393104-5 |             |             |
| KRPA-14AG-240 |                |                  | 240VAC    |             | 6-1393104-8 |             |             |
| KRPA-14AN-24  |                |                  | 24VAC     | Indicator   | 7-1393104-4 |             |             |
| KRPA-14AN-120 |                |                  | 120VAC    |             | 7-1393104-3 |             |             |
| KRPA-14AN-240 |                |                  | 240VAC    |             | 7-1393104-5 |             |             |
| KRPA-14AY-24  |                |                  | Ag        | AgCdO       | 24VAC       | None        | 7-1393104-8 |
| KRPA-14AY-120 |                |                  |           |             | 120VAC      |             | 7-1393104-7 |
| KRPA-14AY-240 |                |                  |           |             | 240VAC      |             | 7-1393104-9 |
| KRPA-14DG-12  | AgCdO          | AgCdO            | 12VDC     |             | 8-1393104-2 |             |             |
| KRPA-14DG-24  |                |                  | 24VDC     |             | 8-1393104-4 |             |             |
| KRPA-14DG-48  |                |                  | 48VDC     |             | 8-1393104-5 |             |             |
| KRPA-14DG-110 |                |                  | 110VDC    |             | 8-1393104-1 |             |             |
| KRPA-14DG-125 |                |                  | 125VDC    |             | 8-1393104-3 |             |             |
| KRPA-14DN-24  |                |                  |           | 24VDC       | Indicator   | 9-1393104-0 |             |
| KRPA-14DY-24  |                |                  | Ag        |             |             | None        | 9-1393104-3 |



Компания «ЭлектроПласт» предлагает заключение долгосрочных отношений при поставках импортных электронных компонентов на взаимовыгодных условиях!

Наши преимущества:

- Оперативные поставки широкого спектра электронных компонентов отечественного и импортного производства напрямую от производителей и с крупнейших мировых складов;
- Поставка более 17-ти миллионов наименований электронных компонентов;
- Поставка сложных, дефицитных, либо снятых с производства позиций;
- Оперативные сроки поставки под заказ (от 5 рабочих дней);
- Экспресс доставка в любую точку России;
- Техническая поддержка проекта, помощь в подборе аналогов, поставка прототипов;
- Система менеджмента качества сертифицирована по Международному стандарту ISO 9001;
- Лицензия ФСБ на осуществление работ с использованием сведений, составляющих государственную тайну;
- Поставка специализированных компонентов (Xilinx, Altera, Analog Devices, Intersil, Interpoint, Microsemi, Aeroflex, Peregrine, Syfer, Eurofarad, Texas Instrument, Miteq, Cobham, E2V, MA-COM, Hittite, Mini-Circuits, General Dynamics и др.);

Помимо этого, одним из направлений компании «ЭлектроПласт» является направление «Источники питания». Мы предлагаем Вам помощь Конструкторского отдела:

- Подбор оптимального решения, техническое обоснование при выборе компонента;
- Подбор аналогов;
- Консультации по применению компонента;
- Поставка образцов и прототипов;
- Техническая поддержка проекта;
- Защита от снятия компонента с производства.



#### Как с нами связаться

**Телефон:** 8 (812) 309 58 32 (многоканальный)

**Факс:** 8 (812) 320-02-42

**Электронная почта:** [org@eplast1.ru](mailto:org@eplast1.ru)

**Адрес:** 198099, г. Санкт-Петербург, ул. Калинина, дом 2, корпус 4, литера А.