

KRPA Series Panel Plug-in Relay

- 5 to 10A current capability
- Contact arrangements of 1, 2 and 3 form C (CO)
- Octal type termination for quick installation
- Indicator lamp available on certain models



Typical applications
Baggage handling, lighting, inspection equipment, marine.

Approvals

UL E22575; CSA LR15734
Technical data of approved types on request.

Contact Data

| | | |
|-------------------------------|---|---------------|
| Contact arrangement | 1 form C (CO), 2 form C (CO), 3 form C (CO) | |
| Rated voltage | 240VAC | |
| Rated current | 10A | |
| Contact material | Ag | AgCdO |
| Min. recommended contact load | 100mA, 12VDC | 300mA, 12VDC |
| Frequency of operation | 360 ops./hour | 360 ops./hour |

Contact ratings

| Type | Load | Cycles |
|----------------------|----------------|-------------------------|
| UL 508 | | |
| KRPA, Ag | 5A, 120VAC | 100x10 ³ |
| | 3A, 240VAC | 100x10 ³ |
| | 1/10HP, 120VAC | 1x10 ³ |
| | 1/6HP, 240VAC | 1x10 ³ |
| KRPA, AgCdO | 10A, 240VAC | 100x10 ³ |
| | 1/3HP, 120VAC | 1x10 ³ |
| | 1/2HP, 240VAC | 1x10 ³ |
| KA, Ag | 5A, 120VAC | |
| | 3A, 240VAC | |
| | 1/10HP, 120VAC | |
| | 1/6HP, 240VAC | |
| KA, AgCdO | 10A, 120VAC | |
| | 6A, 240VAC | |
| | 1/6HP, 120VAC | |
| | 1/3HP, 240VAC | |
| Mechanical endurance | | 10x10 ⁶ ops. |

Coil Data

| | |
|-------------------------------------|----------------------------|
| Coil voltage range | 6 to 220VDC 6 to 240VAC |
| Coil insulation system according UL | Class B |

Coil versions, DC coil

| Coil code | Rated voltage VDC | Operate voltage VDC | Coil resistance Ω±10% | Rated coil power W |
|-----------|-------------------|---|-----------------------|--------------------|
| 6 | 6 | 4.5 | 32 | 1.15 |
| 12 | 12 | 9.0 | 120 | 1.2 |
| 24 | 24 | 18.0 | 472 | 1.25 |
| 48 | 48 | 36.0 | 1800 | 1.3 |
| 110 | 110 | 82.5 | 10000 | 1.2 |
| - | 220 | Use 110V relay with 10KΩ, 5W resistor in series | | |

All figures are given for coil without preenergization, at ambient temperature +23°C.

Coil Data (continued)

Coil versions, AC coil

| Coil code | Rated voltage VAC | Operate voltage VAC | Coil resistance Ω±15% | Rated coil power VA |
|-----------|-------------------|---------------------|-----------------------|---------------------|
| 6 | 6 | 5.1 | 6 | 2.01 |
| 12 | 12 | 10.2 | 24 | 2.02 |
| 24 | 24 | 20.4 | 85 | 2.02 |
| 120 | 120 | 102.0 | 2250 | 2.1 |
| 240 | 240 | 204.0 | 9110 | 2.1 |

All figures are given for coil without preenergization, at ambient temperature +23°C.

Insulation Data

| | | |
|-------------------------------|--|---------------------------|
| Initial dielectric strength | | |
| between open contacts | | 1000V _{rms} |
| between contact and coil | | 1000V _{rms} |
| between adjacent contacts | | 1000V _{rms} |
| Initial insulation resistance | | |
| between insulated elements | | KRPA: 1000MΩ KA: 100MΩ |

Other Data

Material compliance: EU RoHS/ELV, China RoHS, REACH, Halogen content refer to the Product Compliance Support Center at www.te.com/customer-support/rohssupportcenter

| | |
|--------------------------------------|--|
| Ambient temperature | |
| DC coil | KRPA: -45°C to 70°C KA: -45°C to 85°C |
| AC coil | KRPA: -45°C to 55°C KA: -45°C to 70°C |
| Category of environmental protection | |
| IEC 61810 | RT1 - dust protected KRPA and RTO - open style KA |
| Terminal type | |
| | KRPA: 8- or 11-pin octal-type plug KA: solder terminals |
| Weight | 85g |
| Packaging/unit | tray/25 pcs., box/150pcs. |

Accessories

For details see datasheet Sockets and Accessories, KRPA Relays

| Product Code | Description |
|--------------|---|
| 27E891 | Two pole DIN socket (use 20C318 clip) |
| 27E892 | Three pole DIN socket (use 20C318 clip) |
| 27E122 | Two pole track mount socket (use 20C318 clip) |
| 27E123 | Three pole track mount socket (use 20C318 clip) |

KRPA Series Panel Plug-in Relay (Continued)

Dimensions

KRPA

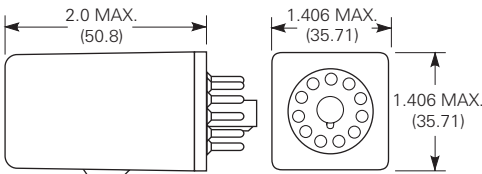

KA

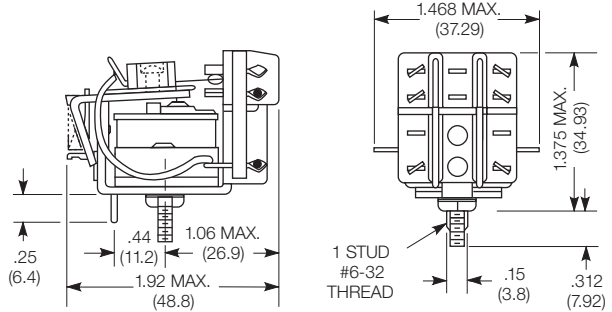

Terminal assignment

KRPA

1 form C

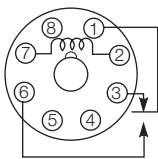

KRPA

2 form C

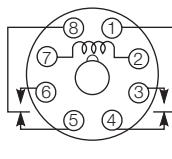

KRPA

3 form C

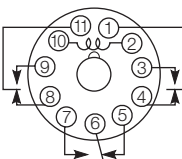

KA

1 form C

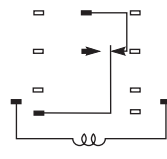

KA

2 form C

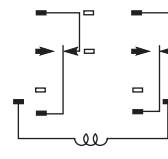

KA

3 form C

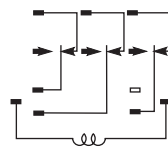

Product code structure

Typical product code **KRPA -5 A Y -120**

Type

- KRPA** Enclosed relay with octal-style plug
- KA** Open style relay with solder terminals

Contact arrangement and rating

- 5** 1 form C (CO)
- 11** 2 form C (CO)
- 14** 3 form C (CO)

Coil Input

- A** AC, 50/60Hz
- D** DC

Contact material and indicator lamp option

- Y** Ag, no indicator lamp
- G** AgCdO, no indicator lamp
- N** AgCdO, with indicator (Code N only available with relay type KRPA)

Options

- Leave blank** no additional options
- F** Au flashed contacts (Options F and P only available with relay type KRPA)
- P** Push to test button

Coil voltage

Coil code: please refer to coil versions table

KRPA Series Panel Plug-in Relay (Continued)

| Product Code | Arrangement | Contact Material | Coil | Option | Part Number | | |
|---------------|----------------|------------------|--------|-------------|----------------|-------------|-------------|
| KA-5AG-120 | 1 form C, 1 CO | AgCdO | 120VAC | Open style | 7-1393099-1 | | |
| KA-5AY-120 | | Ag | | | 7-1393099-3 | | |
| KA-5DG-6 | | AgCdO | | | 6VDC | 7-1393099-9 | |
| KA-5DG-12 | | | | | 12VDC | 7-1393099-7 | |
| KA-5DG-110 | | | 110VDC | 7-1393099-6 | | | |
| KA-11AG-120 | 2 form C, 2 CO | Ag | 120VAC | | 3-1393099-6 | | |
| KA-11AY-6 | | | 6VAC | 4-1393099-1 | | | |
| KA-11AY-24 | | | 24VAC | 4-1393099-0 | | | |
| KA-11AY-120 | | | 120VAC | 3-1393099-9 | | | |
| KA-11DG-12 | AgCdO | | 12VDC | | 4-1393099-3 | | |
| KA-11DG-24 | | | 24VDC | 4-1393099-5 | | | |
| KA-11DG-110 | | | 110VDC | 4-1393099-2 | | | |
| KA-14AG-120 | | | 120VAC | 5-1393099-0 | | | |
| KA-14AY-120 | 3 form C, 3 CO | Ag | | | 5-1393099-4 | | |
| KA-14DG-24 | | | | | AgCdO | 24VDC | 5-1393099-7 |
| KA-14DG-110 | | | | | | 110VDC | 5-1393099-5 |
| KRPA-5AG-24 | | | | | 1 form C, 1 CO | | 24VAC |
| KRPA-5AG-120 | | | 120VAC | | 9-1393104-8 | | |
| KRPA-5DG-6 | | | 6VDC | | 1393105-5 | | |
| KRPA-5DG-12 | | | 12VDC | | 1393105-3 | | |
| KRPA-5DG-24 | | | 24VDC | | 1393105-4 | | |
| KRPA-5DY-12 | | Ag | 12VDC | | 1393105-6 | | |
| KRPA-5DY-24 | | | 24VDC | | 1393105-7 | | |
| KRPA-11AG-6 | 2 form C, 2 CO | AgCdO | 6VAC | | 2-1393104-8 | | |
| KRPA-11AG-12 | | | 12VAC | | 2-1393104-4 | | |
| KRPA-11AG-24 | | | 24VAC | | 1-1393105-2 | | |
| KRPA-11AG-120 | | | 120VAC | | 2-1393104-5 | | |
| KRPA-11AG-240 | | | 240VAC | | 2-1393104-7 | | |
| KRPA-11AN-12 | | | 12VAC | Indicator | 3-1393104-1 | | |
| KRPA-11AN-24 | | | 24VAC | | 3-1393104-3 | | |
| KRPA-11AN-120 | | | 120VAC | | 3-1393104-2 | | |
| KRPA-11AN-240 | | | 240VAC | | 3-1393104-4 | | |
| KRPA-11AY-6 | | Ag | 6VAC | None | 3-1393104-9 | | |
| KRPA-11AY-12 | | | 12VAC | | 3-1393104-5 | | |
| KRPA-11AY-24 | | | 24VAC | | 3-1393104-7 | | |
| KRPA-11AY-120 | | | 120VAC | | 3-1393104-6 | | |
| KRPA-11AY-240 | | | 240VAC | | 3-1393104-8 | | |
| KRPA-11DG-6 | | AgCdO | 6VDC | | 4-1393104-7 | | |
| KRPA-11DG-12 | | | 12VDC | | 4-1393104-3 | | |
| KRPA-11DG-24 | | | 24VDC | | 4-1393104-5 | | |
| KRPA-11DG-48 | | | 48VDC | | 4-1393104-6 | | |
| KRPA-11DG-110 | | | 110VDC | | 4-1393104-2 | | |
| KRPA-11DG-125 | | | 125VDC | | 4-1393104-4 | | |
| KRPA-11DG-24 | | | 24VDC | | 4-1393104-5 | | |
| KRPA-11DG-48 | | | 48VDC | | 4-1393104-6 | | |
| KRPA-11DN-12 | | | 12VDC | Indicator | 5-1393104-0 | | |
| KRPA-11DN-24 | | | 24VDC | | 5-1393104-1 | | |
| KRPA-11DN-110 | | | 110VDC | | 4-1393104-9 | | |
| KRPA-11DY-12 | | Ag | 12VDC | None | 5-1393104-6 | | |
| KRPA-11DY-24 | | | 24VDC | | 5-1393104-7 | | |
| KRPA-14AG-12 | 3 form C, 3 CO | AgCdO | 12VAC | | 6-1393104-4 | | |
| KRPA-14AG-24 | | | 24VAC | | 6-1393104-7 | | |
| KRPA-14AG-120 | | | 120VAC | | 6-1393104-5 | | |
| KRPA-14AG-240 | | | 240VAC | | 6-1393104-8 | | |
| KRPA-14AN-24 | | | 24VAC | Indicator | 7-1393104-4 | | |
| KRPA-14AN-120 | | | 120VAC | | 7-1393104-3 | | |
| KRPA-14AN-240 | | | 240VAC | | 7-1393104-5 | | |
| KRPA-14AY-24 | | Ag | 24VAC | None | 7-1393104-8 | | |
| KRPA-14AY-120 | | | 120VAC | | 7-1393104-7 | | |
| KRPA-14AY-240 | | | 240VAC | | 7-1393104-9 | | |
| KRPA-14DG-12 | | AgCdO | 12VDC | | 8-1393104-2 | | |
| KRPA-14DG-24 | | | 24VDC | | 8-1393104-4 | | |
| KRPA-14DG-48 | | | 48VDC | | 8-1393104-5 | | |
| KRPA-14DG-110 | | | 110VDC | | 8-1393104-1 | | |
| KRPA-14DG-125 | | | 125VDC | | 8-1393104-3 | | |
| KRPA-14DN-24 | | | 24VDC | Indicator | 9-1393104-0 | | |
| KRPA-14DY-24 | | Ag | | | None | 9-1393104-3 | |



Компания «ЭлектроПласт» предлагает заключение долгосрочных отношений при поставках импортных электронных компонентов на взаимовыгодных условиях!

Наши преимущества:

- Оперативные поставки широкого спектра электронных компонентов отечественного и импортного производства напрямую от производителей и с крупнейших мировых складов;
- Поставка более 17-ти миллионов наименований электронных компонентов;
- Поставка сложных, дефицитных, либо снятых с производства позиций;
- Оперативные сроки поставки под заказ (от 5 рабочих дней);
- Экспресс доставка в любую точку России;
- Техническая поддержка проекта, помощь в подборе аналогов, поставка прототипов;
- Система менеджмента качества сертифицирована по Международному стандарту ISO 9001;
- Лицензия ФСБ на осуществление работ с использованием сведений, составляющих государственную тайну;
- Поставка специализированных компонентов (Xilinx, Altera, Analog Devices, Intersil, Interpoint, Microsemi, Aeroflex, Peregrine, Syfer, Eurofarad, Texas Instrument, Miteq, Cobham, E2V, MA-COM, Hittite, Mini-Circuits, General Dynamics и др.);

Помимо этого, одним из направлений компании «ЭлектроПласт» является направление «Источники питания». Мы предлагаем Вам помощь Конструкторского отдела:

- Подбор оптимального решения, техническое обоснование при выборе компонента;
- Подбор аналогов;
- Консультации по применению компонента;
- Поставка образцов и прототипов;
- Техническая поддержка проекта;
- Защита от снятия компонента с производства.



Как с нами связаться

Телефон: 8 (812) 309 58 32 (многоканальный)

Факс: 8 (812) 320-02-42

Электронная почта: org@eplast1.ru

Адрес: 198099, г. Санкт-Петербург, ул. Калинина, дом 2, корпус 4, литера А.