

SERIES 84LS
Sealed, Low Profile

FEATURES

- Waterproof Silicone Rubber
- Easily Customized Legends
- Audible, Tactile Contacts
- Low Contact Resistance
- Optional RFI/EMI Shielding
- 3,000,000 Operations per Button

DESCRIPTION

The Series 84LS is the low profile version of Grayhill's popular Series 84S sealed keypads. These keypads are legended by epoxy ink printing the rubber key tops. Custom legends and colors are available at a nominal cost. The Series 84LS is offered with a choice of matrix or single pole/common bus circuitries and EMI shielding.



DIMENSIONS in inches (and millimeters)

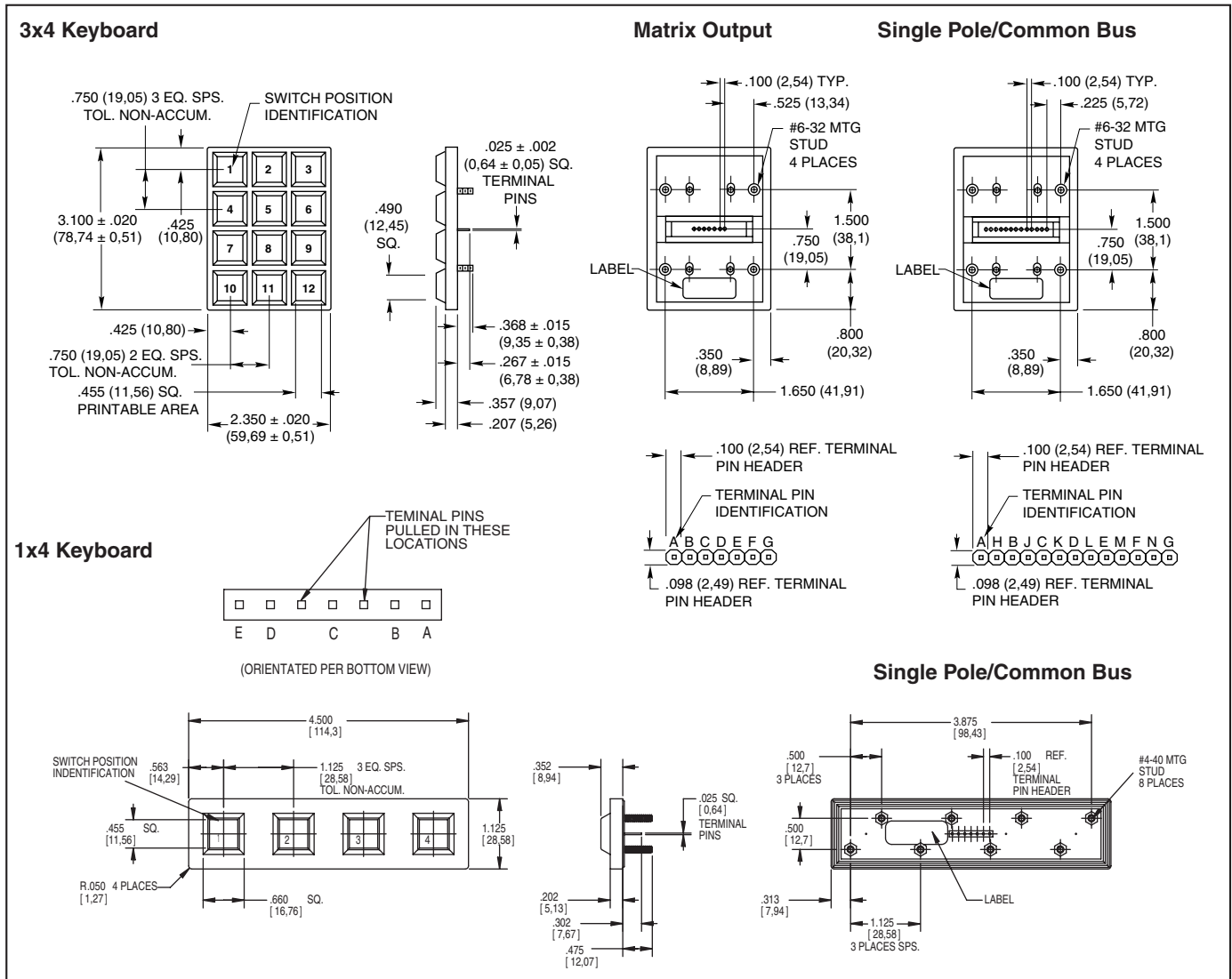

DIMENSIONS in inches (and millimeters)

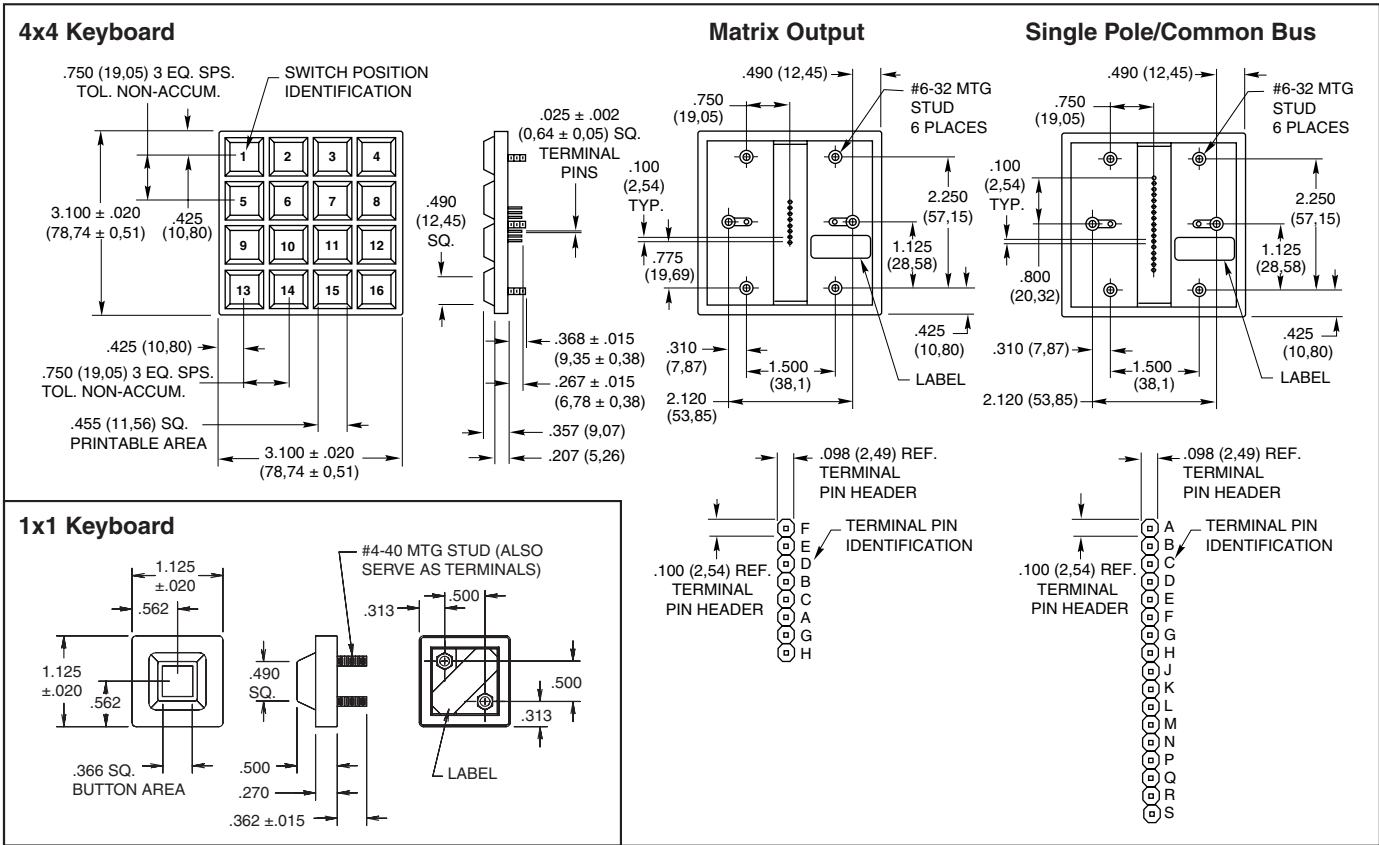

Keyboards and Key pads

CODE AND TRUTH TABLES

The chart indicates the relationship of the terminal pins to each key switch. The dot indicates a closed switch. Terminals are identified on the keyboard.

4 Button Key pads

BUTTON LOCATION	CODES PINS				
	1	•	•	•	•
2	•	•	•	•	•
3	•	•	•	•	•
4	•	•	•	•	•
	A	B	C	D	E
	TERMINAL LOCATION				

12 Button Key pads

BUTTON LOCATION	CODES																			
	Matrix						Single Pole/Common Bus													
1	•	•	•	•	•	•	•	•	•	•	•	•								
2	•	•	•	•	•	•	•	•	•	•	•	•								
3	•	•	•	•	•	•	•	•	•	•	•	•								
4	•	•	•	•	•	•	•	•	•	•	•	•								
5	•	•	•	•	•	•	•	•	•	•	•	•								
6	•	•	•	•	•	•	•	•	•	•	•	•								
7	•	•	•	•	•	•	•	•	•	•	•	•								
8	•	•	•	•	•	•	•	•	•	•	•	•								
9	•	•	•	•	•	•	•	•	•	•	•	•								
10	•	•	•	•	•	•	•	•	•	•	•	•								
11	•	•	•	•	•	•	•	•	•	•	•	•								
12	•	•	•	•	•	•	•	•	•	•	•	•								
	C	B	A	G	F	E	D	E	C	B	F	D	A	N	K	H	M	L	J	G
	TERMINAL LOCATION																			

16 Button Key pads

BUTTON LOCATION	CODES																								
	Matrix								Single Pole/Common Bus																
1	•	•	•	•	•	•	•	•	•	•	•	•	•	•	•	•									
2	•	•	•	•	•	•	•	•	•	•	•	•	•	•	•	•									
3	•	•	•	•	•	•	•	•	•	•	•	•	•	•	•	•									
4	•	•	•	•	•	•	•	•	•	•	•	•	•	•	•	•									
5	•	•	•	•	•	•	•	•	•	•	•	•	•	•	•	•									
6	•	•	•	•	•	•	•	•	•	•	•	•	•	•	•	•									
7	•	•	•	•	•	•	•	•	•	•	•	•	•	•	•	•									
8	•	•	•	•	•	•	•	•	•	•	•	•	•	•	•	•									
9	•	•	•	•	•	•	•	•	•	•	•	•	•	•	•	•									
10	•	•	•	•	•	•	•	•	•	•	•	•	•	•	•	•									
11	•	•	•	•	•	•	•	•	•	•	•	•	•	•	•	•									
12	•	•	•	•	•	•	•	•	•	•	•	•	•	•	•	•									
13	•	•	•	•	•	•	•	•	•	•	•	•	•	•	•	•									
14	•	•	•	•	•	•	•	•	•	•	•	•	•	•	•	•									
15	•	•	•	•	•	•	•	•	•	•	•	•	•	•	•	•									
16	•	•	•	•	•	•	•	•	•	•	•	•	•	•	•	•									
	A	B	C	D	E	F	G	H	D	B	A	C	H	F	E	G	K	M	L	J	P	R	Q	N	S
	TERMINAL LOCATION																								

SPECIFICATIONS

- Rating Criteria**
- Rating at 24 Vdc: ≤ 10 milliamps resistive
- Contact Bounce: 4 milliseconds maximum at make; 10 milliseconds, at break
- Contact Resistance: MOS, TTL, and DTL compatible. (10 ohms maximum)
- Operating Temperature: -55°C to 85°C

- Life Expectancy: 3 million operations/button
- Insulation Resistance: 1,000 megohms
- Operating Features
- Pre-Travel: .030 inches minimum
- Operating Force: 20 ± 4 ounces
- Humidity: 0 to 98% (no condensation)
- Minimum Push Out Force Per Pin: 5 pounds

- Materials and Finishes**
- Terminal Pins: Copper alloy CDA 725
- PC Board: FR-4 glass cloth epoxy
- Dome Retainer/Rear Seal Sheet: Polyester
- Mounting Studs: Phosphor bronze
- Optional Hex Nut: Stainless steel, passivated
- Optional EMI Shield: Aluminum foil
- Keypad: Silicone rubber

Shielding Effectiveness

Results shown are typical for a standard Grayhill Series 84LS Keyboard. A conductive gasket will generally increase the shielding, depending on the size and shape of the gasket and its material. Data derived for E-Field Radiation.

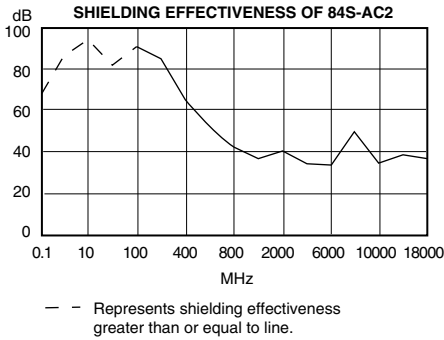

Frequency MHz	Rating in dB
0.1	66.2
10	94.8
100	89.0
400	70.6
800	42.5
2,000	39.5
6,000	32.6
10,000	45.2
18,000	42.2

the frequency source that was radiated from the transmitting antenna to the enclosed receiving antenna. The spacing between antennas was maintained constant throughout the frequency range. The effectiveness rating is determined by establishing a reference reading without obstruction between the two antennas and determining the difference between that reading and the test setup reading.

Note:

When measured in actual equipment, shielding effectiveness is determined by many factors. This method accurately represents the shielding effectiveness of the Grayhill Series 84LS under ideal test conditions.

Test Method:

Measurements were made with the keyboard mounted to a brass plate, which in turn was mounted to a shielded enclosure containing the receiving equipment. A signal generator provided

Keyboards and Keypads

STANDARD LEGENDS

Available through Grayhill Distributors

To order one of the configurations below, use the dash number shown here; select the keypad size and code, and order the part number with the appropriate legend dash number.

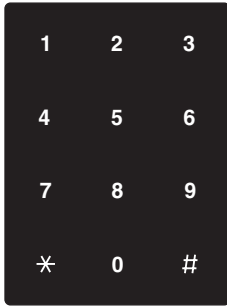

-112

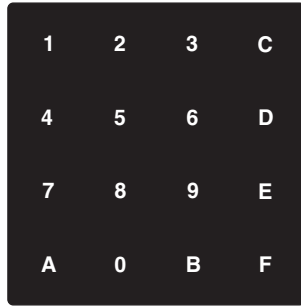

-014

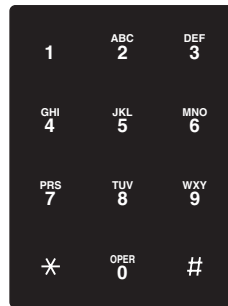

-113

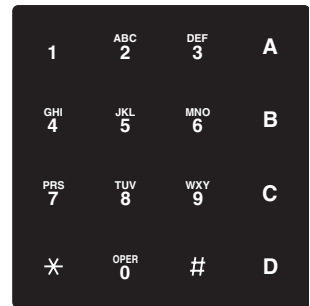

-016



-301

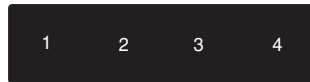

-302



-201

CUSTOM LEGENDS

Any reasonable legend can be printed in the key area. Fax a sketch of your requirements to Grayhill. Printing and symbols will be coordinated in keeping with concepts of good design. Or, if required, the details of your submitted artwork

will be matched as closely as possible. Allow 3 to 4 weeks for custom legend delivery. A nominal charge, depending on the total quantity of keypads ordered and the complexity of the legend, will be assessed.

HEADER CONNECTORS

Compatible with:
Samtec, Inc. Header Series BCS, BSW, CES, ESW, ESQ, SLW, SSW, SSS, IDSS and IDSD or equivalent.

ORDERING INFORMATION

Grayhill Series Number
Shielded or Non-Shielded Option
 S = Shielded
 SN = Non-Shielded
Size Option
 A = 3x4 B = 4x4 C = 1x1 F = 1x4
Circuitry Option
 B2 = Matrix in-line pins C2 = Single pole/common bus, in-line pins

84LS-AC2-113-N

Mounting Nut Option
 N = Provided with hex nuts for mounting
 Blank = Nuts not provided
Standard Legend Choices
 3x4 Size, choose -112 or -113
 4x4 Size, choose -014 or -016
 1x4 Size, choose -301 or -302
 1x1 Size, choose -201

Available from your local Grayhill Distributor.
 For prices and discounts, contact a local Sales Office, an authorized local distributor or Grayhill.



Компания «ЭлектроПласт» предлагает заключение долгосрочных отношений при поставках импортных электронных компонентов на взаимовыгодных условиях!

Наши преимущества:

- Оперативные поставки широкого спектра электронных компонентов отечественного и импортного производства напрямую от производителей и с крупнейших мировых складов;
- Поставка более 17-ти миллионов наименований электронных компонентов;
- Поставка сложных, дефицитных, либо снятых с производства позиций;
- Оперативные сроки поставки под заказ (от 5 рабочих дней);
- Экспресс доставка в любую точку России;
- Техническая поддержка проекта, помощь в подборе аналогов, поставка прототипов;
- Система менеджмента качества сертифицирована по Международному стандарту ISO 9001;
- Лицензия ФСБ на осуществление работ с использованием сведений, составляющих государственную тайну;
- Поставка специализированных компонентов (Xilinx, Altera, Analog Devices, Intersil, Interpoint, Microsemi, Aeroflex, Peregrine, Syfer, Eurofarad, Texas Instrument, Miteq, Cobham, E2V, MA-COM, Hittite, Mini-Circuits, General Dynamics и др.);

Помимо этого, одним из направлений компании «ЭлектроПласт» является направление «Источники питания». Мы предлагаем Вам помощь Конструкторского отдела:

- Подбор оптимального решения, техническое обоснование при выборе компонента;
- Подбор аналогов;
- Консультации по применению компонента;
- Поставка образцов и прототипов;
- Техническая поддержка проекта;
- Защита от снятия компонента с производства.



Как с нами связаться

Телефон: 8 (812) 309 58 32 (многоканальный)

Факс: 8 (812) 320-02-42

Электронная почта: org@eplast1.ru

Адрес: 198099, г. Санкт-Петербург, ул. Калинина, дом 2, корпус 4, литера А.