

## MAX6138

## 0.1%, 25ppm, SC70 Shunt Voltage Reference with Multiple Reverse Breakdown Voltages

### General Description

The MAX6138 is a precision, two-terminal shunt mode, bandgap voltage reference available in fixed reverse breakdown voltages of 1.2205V, 2.048V, 2.5V, 3.0V, 3.3V, 4.096V, and 5.0V. Ideal for space-critical applications, the MAX6138 is offered in the subminiature 3-pin SC70 surface-mount package (1.8mm x 1.8mm), 50% smaller than comparable devices in SOT23 surface-mount packages.

Laser-trimmed resistors ensure precise initial accuracy. With a 25ppm/°C temperature coefficient, the device is offered in three grades of initial accuracy ranging from 0.1% to 0.5%. The MAX6138 has a 60µA to 15mA shunt-current capability with low-dynamic impedance, ensuring stable reverse breakdown voltage accuracy over a wide range of operating temperatures and currents.

The MAX6138 does not require an external stabilizing capacitor while ensuring stability with capacitive loads. The MAX6138 is a higher precision device in a smaller package than the LM4040/LM4050.

### Applications

- Portable, Battery-Powered Equipment
- Notebook Computers
- Cell Phones
- Industrial Process Control

### Pin Configuration

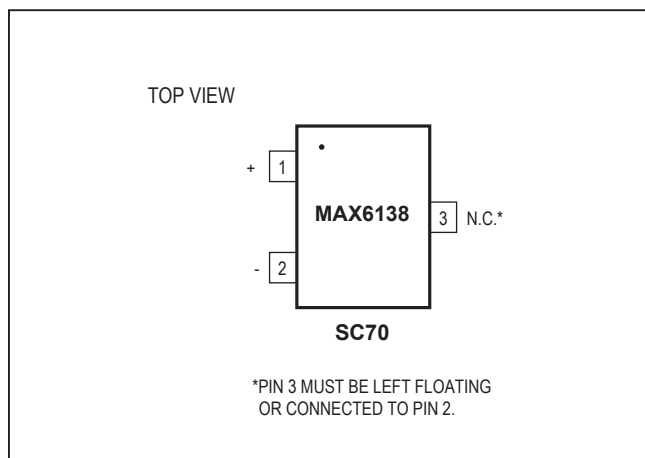

### Features

- Ultra-Small 3-Pin SC70 Package
- 0.1% (max) Initial Accuracy
- 25ppm/°C (max) Temperature Coefficient Guaranteed Over -40°C to +85°C Temperature Range
- Wide Operating Current Range: 60µA to 15mA
- Low 28µV<sub>RMS</sub> Output Noise (10Hz to 10kHz)
- 1.2205V, 2.048V, 2.5V, 3.0V, 3.3V, 4.096V, and 5.0V Fixed Reverse Breakdown Voltages
- No Output Capacitors Required
- Stable with Capacitive Loads

### Selector Guide

PART	TEMP RANGE	PIN-PACKAGE	OUTPUT VOLTAGE (V)
MAX6138_EXR12-T	-40°C to +85°C	3 SC70-3	1.2205
MAX6138_EXR21-T	-40°C to +85°C	3 SC70-3	2.0480
MAX6138_EXR25-T	-40°C to +85°C	3 SC70-3	2.5000
MAX6138_EXR30-T	-40°C to +85°C	3 SC70-3	3.0000
MAX6138_EXR33-T	-40°C to +85°C	3 SC70-3	3.3000
MAX6138_EXR41-T	-40°C to +85°C	3 SC70-3	4.0960
MAX6138_EXR50-T	-40°C to +85°C	3 SC70-3	5.0000

**Ordering Information** appears at end of data sheet.

### Typical Operating Circuit

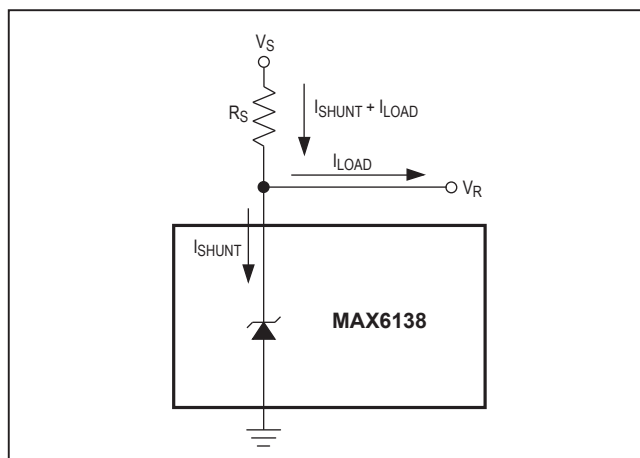

# MAX6138

# 0.1%, 25ppm, SC70 Shunt Voltage Reference with Multiple Reverse Breakdown Voltages

## Absolute Maximum Ratings

Reverse Current (cathode to anode).....	20mA	Operating Temperature Range.....	-40°C to +85°C
Forward Current (anode to cathode).....	10mA	Storage Temperature Range.....	-65°C to +150°C
Continuous Power Dissipation (T <sub>A</sub> = +70°C)		Junction Temperature.....	+150°C
3-Pin SC70 (derate 2.17mW/°C above +70°C).....	174mW	Lead Temperature (soldering, 10s) .....	+300°C

Stresses beyond those listed under "Absolute Maximum Ratings" may cause permanent damage to the device. These are stress ratings only, and functional operation of the device at these or any other conditions beyond those indicated in the operational sections of the specifications is not implied. Exposure to absolute maximum rating conditions for extended periods may affect device reliability.

## Electrical Characteristics—MAX6138\_12 (1.2205V)

(I<sub>R</sub> = 100µA, T<sub>A</sub> = -40°C to +85°C, unless otherwise noted. Typical values are at T<sub>A</sub> = +25°C.) (Note 1)

PARAMETER	SYMBOL	CONDITIONS	MIN	TYP	MAX	UNITS	
Reverse Breakdown Voltage (Note 2)	V <sub>R</sub>	T <sub>A</sub> = +25°C	MAX6138A (0.1%)	1.2193	1.2205	1.2217	V
			MAX6138B (0.2%)	1.2181	1.2205	1.2229	
			MAX6138C (0.5%)	1.2144	1.2205	1.2266	
Minimum Operating Current	I <sub>RMIN</sub>			45	60	µA	
Reverse Voltage Temperature Coefficient (Notes 2, 3)	TC			4	25	ppm/°C	
Reverse Breakdown Voltage Change with Operating Current Change	ΔV <sub>R</sub> /ΔI <sub>R</sub>	I <sub>RMIN</sub> ≤ I <sub>R</sub> ≤ 1mA		0.3	1.0	mV	
		1mA ≤ I <sub>R</sub> ≤ 12mA		2.5	8.0		
Reverse Dynamic Impedance (Note 3)	Z <sub>R</sub>	I <sub>R</sub> = 1mA, f = 120Hz, I <sub>AC</sub> = 0.1I <sub>R</sub>		0.3	0.8	Ω	
Wideband Noise	e <sub>N</sub>	I <sub>R</sub> = 10µA, 10Hz ≤ f ≤ 10kHz		20		µV <sub>RMS</sub>	
Reverse Breakdown Voltage	ΔV <sub>R</sub>	t = 1000h		120		ppm	

## MAX6138

0.1%, 25ppm, SC70 Shunt Voltage Reference  
with Multiple Reverse Breakdown Voltages

## Electrical Characteristics—MAX6138\_21 (2.048V)

(I<sub>R</sub> = 100μA, T<sub>A</sub> = -40°C to +85°C, unless otherwise noted. Typical values are at T<sub>A</sub> = +25°C.) (Note 1)

PARAMETER	SYMBOL	CONDITIONS		MIN	TYP	MAX	UNITS
Reverse Breakdown Voltage (Note 2)	V <sub>R</sub>	T <sub>A</sub> = +25°C	MAX6138A (0.1%)	2.0460	2.0480	2.0500	V
			MAX6138B (0.2%)	2.0439	2.0480	2.0521	
			MAX6138C (0.5%)	2.0378	2.0480	2.0582	
Minimum Operating Current	I <sub>RMIN</sub>			45	65		μA
Reverse Voltage Temperature Coefficient (Notes 2, 3)	TC				4	25	ppm/°C
Reverse Breakdown Voltage Change with Operating Current Change	ΔV <sub>R</sub> /ΔI <sub>R</sub>	I <sub>RMIN</sub> ≤ I <sub>R</sub> ≤ 1mA			0.3	1.0	mV
		1mA ≤ I <sub>R</sub> ≤ 15mA			2.5	8.0	
Reverse Dynamic Impedance (Note 3)	Z <sub>R</sub>	I <sub>R</sub> = 1mA, f = 120Hz, I <sub>AC</sub> = 0.1I <sub>R</sub>			0.3	0.8	Ω
Wideband Noise	e <sub>N</sub>	10Hz ≤ f ≤ 10kHz			28		μV <sub>RMS</sub>
Reverse Breakdown Voltage Long-Term Stability	ΔV <sub>R</sub>	t = 1000h			120		ppm

## Electrical Characteristics—MAX6138\_25 (2.5V)

(I<sub>R</sub> = 100μA, T<sub>A</sub> = -40°C to +85°C, unless otherwise noted. Typical values are at T<sub>A</sub> = +25°C.) (Note 1)

PARAMETER	SYMBOL	CONDITIONS		MIN	TYP	MAX	UNITS
Reverse Breakdown Voltage (Note 2)	V <sub>R</sub>	T <sub>A</sub> = +25°C	MAX6138A (0.1%)	2.4975	2.5000	2.5025	V
			MAX6138B (0.2%)	2.4950	2.5000	2.5050	
			MAX6138C (0.2%)	2.4875	2.5000	2.5125	
Minimum Operating Current	I <sub>RMIN</sub>			45	65		μA
Reverse Voltage Temperature Coefficient (Notes 2, 3)	TC				4	25	ppm/°C
Reverse Breakdown Voltage Change with Operating Current Change	ΔV <sub>R</sub> /ΔI <sub>R</sub>	I <sub>RMIN</sub> ≤ I <sub>R</sub> ≤ 1mA			0.3	1.0	mV
Reverse Breakdown Voltage Change with Operating Current Change	ΔV <sub>R</sub> /ΔI <sub>R</sub>	1mA ≤ I <sub>R</sub> ≤ 15mA			2.5	8.0	mV
Reverse Dynamic Impedance (Note 3)	Z <sub>R</sub>	I <sub>R</sub> = 1mA, f = 120Hz, I <sub>AC</sub> = 0.1I <sub>R</sub>			0.3	0.8	Ω
Wideband Noise	e <sub>N</sub>	10Hz ≤ f ≤ 10kHz			35		μV <sub>RMS</sub>
Reverse Breakdown Voltage Long-Term Stability	ΔV <sub>R</sub>	t = 1000h			120		ppm

# MAX6138

# 0.1%, 25ppm, SC70 Shunt Voltage Reference with Multiple Reverse Breakdown Voltages

## Electrical Characteristics—MAX6138\_30 (3.0V)

( $I_R = 100\mu A$ ,  $T_A = -40^\circ C$  to  $+85^\circ C$ , unless otherwise noted. Typical values are at  $T_A = +25^\circ C$ .) (Note 1)

PARAMETER	SYMBOL	CONDITIONS	MIN	TYP	MAX	UNITS	
Reverse Breakdown Voltage (Note 2)	$V_R$	$T_A = +25^\circ C$	MAX6138A (0.1%)	2.9970	3.0000	3.0030	V
			MAX6138B (0.2%)	2.9940	3.0000	3.0060	
			MAX6138C (0.5%)	2.9850	3.0000	3.0150	
Minimum Operating Current	$I_{RMIN}$			45	65	$\mu A$	
Reverse Voltage Temperature Coefficient (Notes 2, 3)	TC			4	25	ppm/ $^\circ C$	
Reverse Breakdown Voltage Change with Operating Current Change	$\Delta V_R / \Delta I_R$	$I_{RMIN} \leq I_R \leq 1mA$		0.3	1.0	mV	
		$1mA \leq I_R \leq 15mA$		2.5	8.0		
Reverse Dynamic Impedance (Note 3)	$Z_R$	$I_R = 1mA$ , $f = 120Hz$ , $I_{AC} = 0.1I_R$		0.3	0.8	$\Omega$	
Wideband Noise	$e_N$	$10Hz \leq f \leq 10kHz$		45		$\mu V_{RMS}$	
Reverse Breakdown Voltage Long-Term Stability	$\Delta V_R$	$t = 1000h$		120		ppm	

## Electrical Characteristics—MAX6138\_33 (3.3V)

( $I_R = 100\mu A$ ,  $T_A = -40^\circ C$  to  $+85^\circ C$ , unless otherwise noted. Typical values are at  $T_A = +25^\circ C$ .) (Note 1)

PARAMETER	SYMBOL	CONDITIONS	MIN	TYP	MAX	UNITS	
Reverse Breakdown Voltage (Note 2)	$V_R$	$T_A = +25^\circ C$	MAX6138A (0.1%)	3.2967	3.3000	3.3033	V
			MAX6138B (0.2%)	3.2934	3.3000	3.3066	
			MAX6138C (0.5%)	3.2835	3.3000	3.3165	
Minimum Operating Current	$I_{RMIN}$			45	67	$\mu A$	
Reverse Voltage Temperature Coefficient (Notes 2, 3)	TC			4	25	ppm/ $^\circ C$	
Reverse Breakdown Voltage Change with Operating Current Change	$\Delta V_R / \Delta I_R$	$I_{RMIN} \leq I_R \leq 1mA$		0.3	1.0	mV	
		$1mA \leq I_R \leq 15mA$			8.0		
Reverse Dynamic Impedance (Note 3)	$Z_R$	$I_R = 1mA$ , $f = 120Hz$ , $I_{AC} = 0.1I_R$		0.3	0.8	$\Omega$	
Wideband Noise	$e_N$	$10Hz \leq f \leq 10kHz$		50		$\mu V_{RMS}$	
Reverse Breakdown Voltage Long-Term Stability	$\Delta V_R$	$t = 1000h$		120		ppm	

# MAX6138

# 0.1%, 25ppm, SC70 Shunt Voltage Reference with Multiple Reverse Breakdown Voltages

## Electrical Characteristics—MAX6138\_41 (4.096V)

( $I_R = 100\mu\text{A}$ ,  $T_A = -40^\circ\text{C}$  to  $+85^\circ\text{C}$ , unless otherwise noted. Typical values are at  $T_A = +25^\circ\text{C}$ .) (Note 1)

PARAMETER	SYMBOL	CONDITIONS	MIN	TYP	MAX	UNITS	
Reverse Breakdown Voltage (Note 2)	$V_R$	$T_A = +25^\circ\text{C}$	MAX6138A (0.1%)	4.0919	4.0960	4.1001	V
			MAX6138B (0.2%)	4.0878	4.0960	4.1042	
			MAX6138C (0.5%)	4.0755	4.0960	4.1165	
Minimum Operating Current	$I_{RMIN}$			50	73	$\mu\text{A}$	
Reverse Voltage Temperature Coefficient (Notes 2, 3)	TC			4	25	ppm/ $^\circ\text{C}$	
Reverse Breakdown Voltage Change with Operating Current Change	$\Delta V_R/\Delta I_R$	$I_{RMIN} \leq I_R \leq 1\text{mA}$		0.5	1.2	mV	
		$1\text{mA} \leq I_R \leq 15\text{mA}$		3.0	10.0		
Reverse Dynamic Impedance (Note 3)	$Z_R$	$I_R = 1\text{mA}$ , $f = 120\text{Hz}$ , $I_{AC} = 0.1I_R$		0.5	1.0	$\Omega$	
Wideband Noise	$e_N$	$10\text{Hz} \leq f \leq 10\text{kHz}$		64		$\mu\text{V}_{RMS}$	
Reverse Breakdown Voltage Long-Term Stability	$\Delta V_R$	$t = 1000\text{h}$		120		ppm	

## Electrical Characteristics—MAX6138\_50 (5.0V)

( $I_R = 100\mu\text{A}$ ,  $T_A = -40^\circ\text{C}$  to  $+85^\circ\text{C}$ , unless otherwise noted. Typical values are at  $T_A = +25^\circ\text{C}$ .) (Note 1)

PARAMETER	SYMBOL	CONDITIONS	MIN	TYP	MAX	UNITS	
Reverse Breakdown Voltage (Note 2)	$V_R$	$T_A = +25^\circ\text{C}$	MAX6138A (0.1%)	4.9950	5.0000	5.0050	V
			MAX6138B (0.2%)	4.9900	5.0000	5.0100	
			MAX6138C (0.5%)	4.9750	5.0000	5.0250	
Minimum Operating Current	$I_{RMIN}$			54	80	$\mu\text{A}$	
Reverse Voltage Temperature Coefficient (Notes 2, 3)	TC			4	25	ppm/ $^\circ\text{C}$	
Reverse Breakdown Voltage Change with Operating Current Change	$\Delta V_R/\Delta I_R$	$I_{RMIN} \leq I_R \leq 1\text{mA}$		0.5	1.4	mV	
		$1\text{mA} \leq I_R \leq 15\text{mA}$		3.5	12.0		
Reverse Dynamic Impedance (Note 3)	$Z_R$	$I_R = 1\text{mA}$ , $f = 120\text{Hz}$ , $I_{AC} = 0.1I_R$		0.5	1.1	$\Omega$	
Wideband Noise	$e_N$	$10\text{Hz} \leq f \leq 10\text{kHz}$		80		$\mu\text{V}_{RMS}$	
Reverse Breakdown Voltage Long-Term Stability	$\Delta V_R$	$t = 1000\text{h}$		120		ppm	

**Note 1:** All devices are 100% production tested at  $+25^\circ\text{C}$  and are guaranteed by correlation for  $T_A = T_{MAX}$  to  $T_{MIN}$ , as specified.

**Note 2:** TC is measured by the “box” method, i.e.  $(V_{MAX} - V_{MIN}) / (T_{MAX} - T_{MIN})$

**Note 3:** Guaranteed by design.

Typical Operating Characteristics

( $I_R = 100\mu A$ ,  $T_A = +25^\circ C$ , unless otherwise noted.)

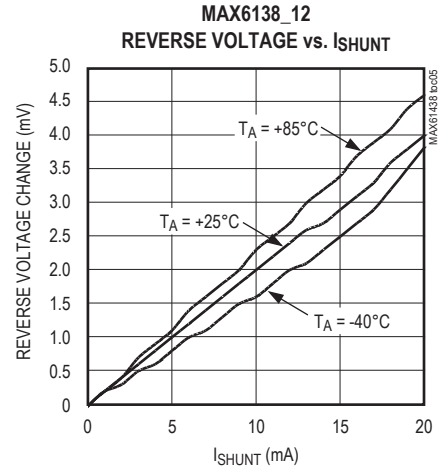
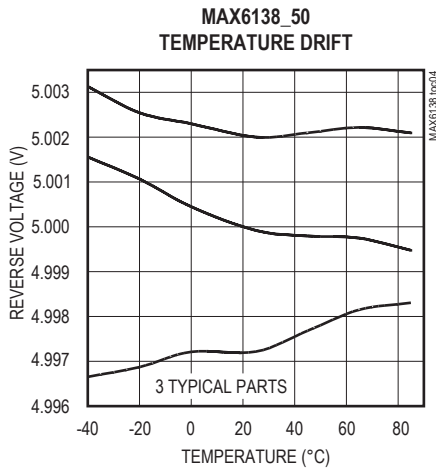
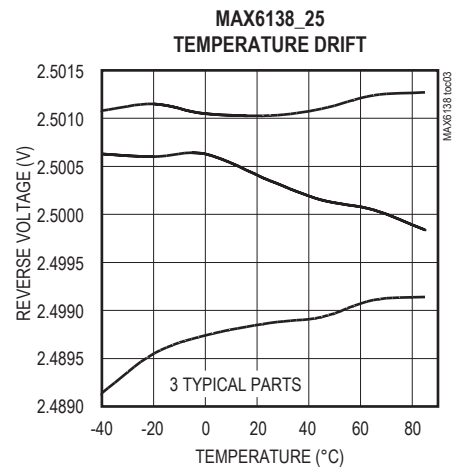
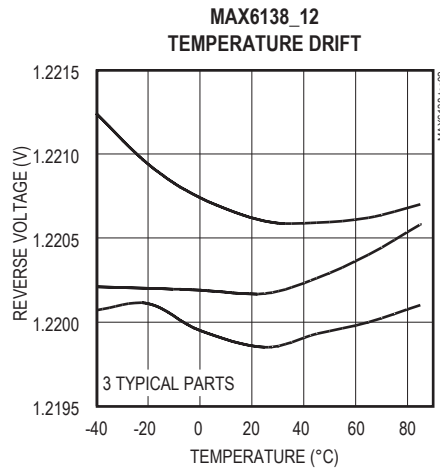
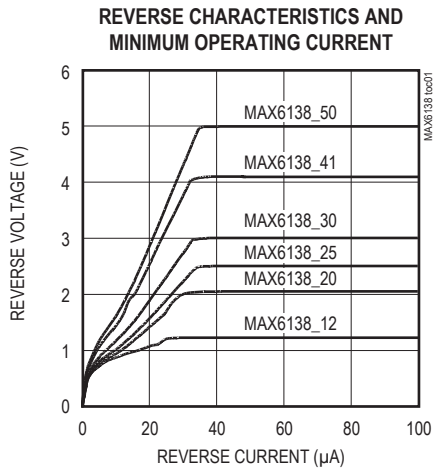

Typical Operating Characteristics (continued)

( $I_R = 100\mu A$ ,  $T_A = +25^\circ C$ , unless otherwise noted.)

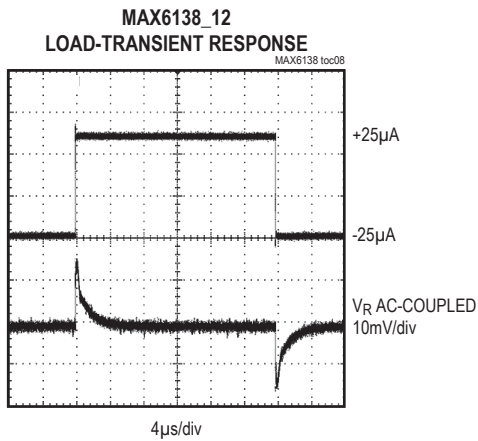
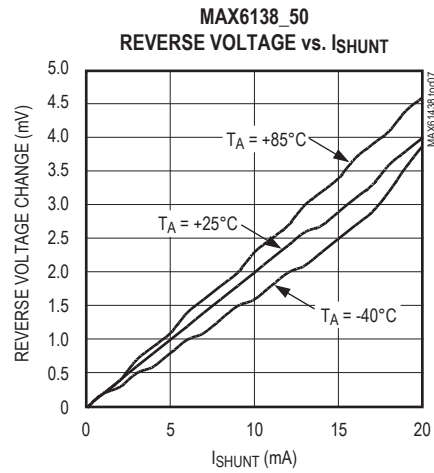
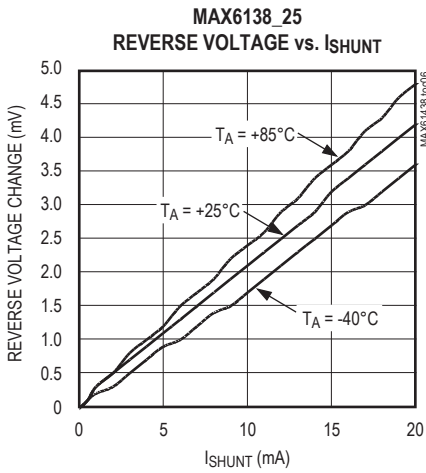

$I_{SHUNT} = 100\mu A \pm 25A$   
 $R_L = 48k\Omega$

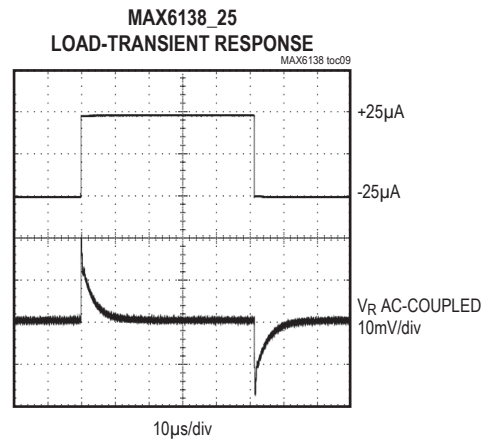

$I_{SHUNT} = 100\mu A$   
 $R_L = 100k\Omega$

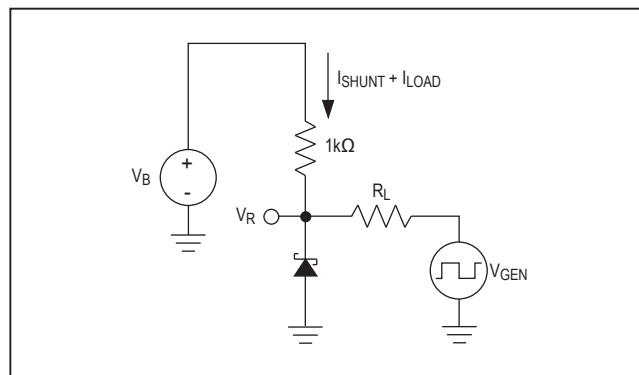

Figure 1. Load-Transient Circuit

Typical Operating Characteristics (continued)

( $I_R = 100\mu A$ ,  $T_A = +25^\circ C$ , unless otherwise noted.)

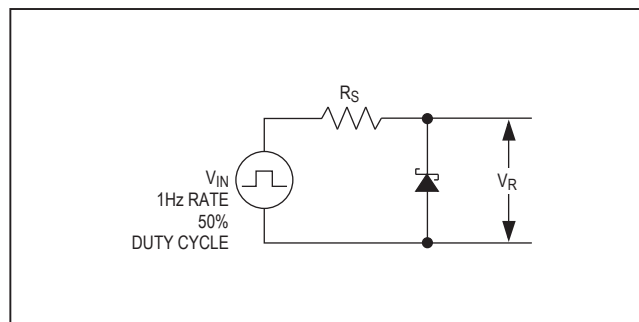
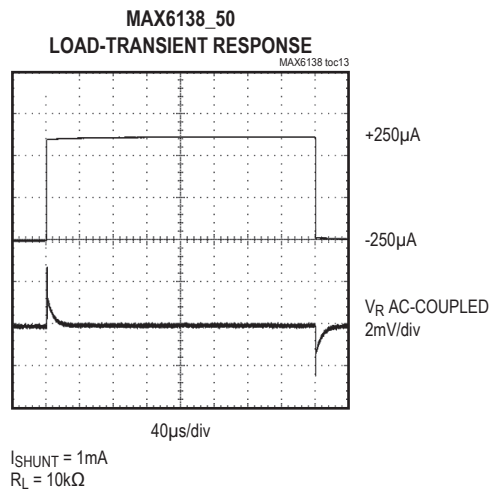
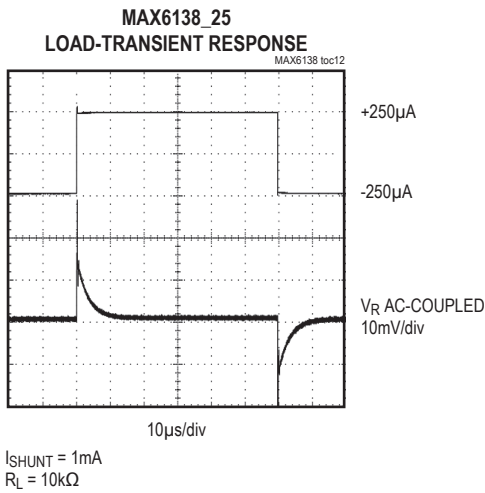
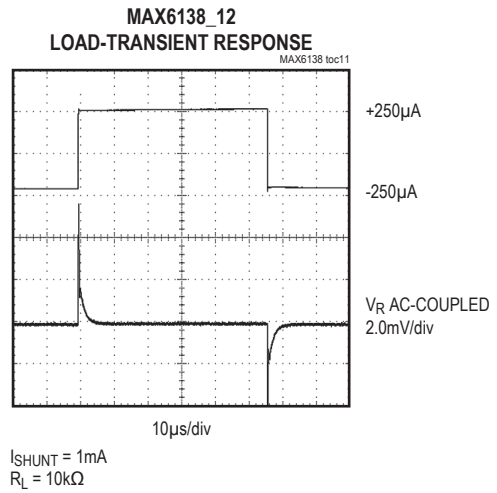
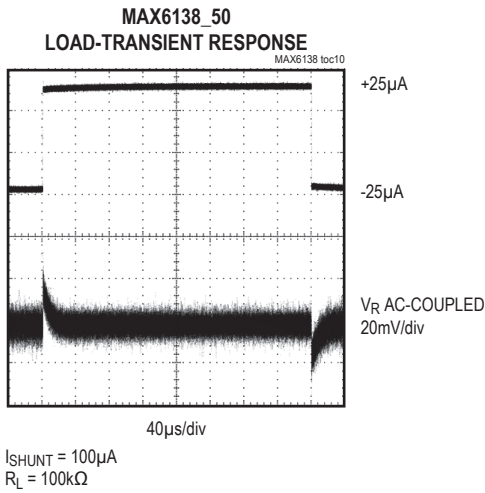

Figure 2. Startup Characteristics Test Circuit



Typical Operating Characteristics (continued)

( $I_R = 100\mu A$ ,  $T_A = +25^\circ C$ , unless otherwise noted.)

MAX6138\_12  
LOAD-TRANSIENT RESPONSE

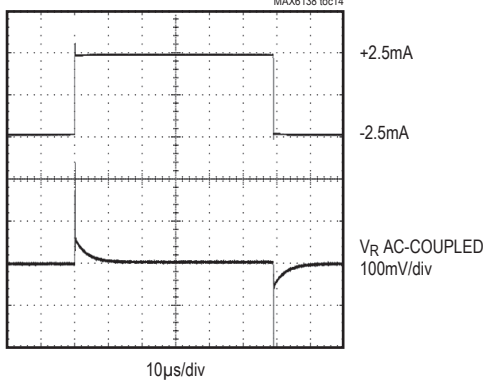

$I_{SHUNT} = 10mA$   
 $R_L = 1k\Omega$

MAX6138\_25  
LOAD-TRANSIENT RESPONSE

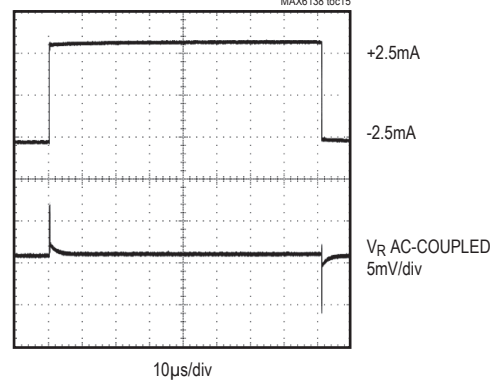

$I_{SHUNT} = 10mA$   
 $R_L = 1k\Omega$

MAX6138\_50  
LOAD-TRANSIENT RESPONSE

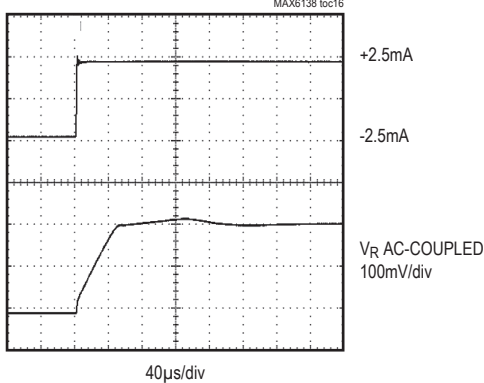

$I_{SHUNT} = 10mA$   
 $R_L = 1k\Omega$

MAX6138\_12  
STARTUP CHARACTERISTICS

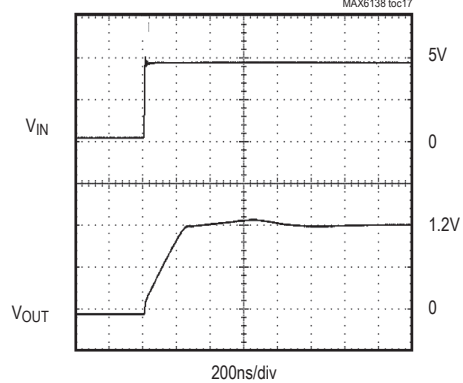

$I_{SHUNT} = 100\mu A$   
 $R_S = 30k\Omega$

MAX6138\_25  
STARTUP CHARACTERISTICS

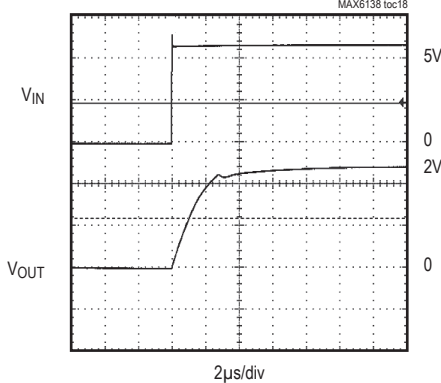

$I_{SHUNT} = 100\mu A$   
 $R_S = 30k\Omega$

MAX6138\_50  
STARTUP CHARACTERISTICS

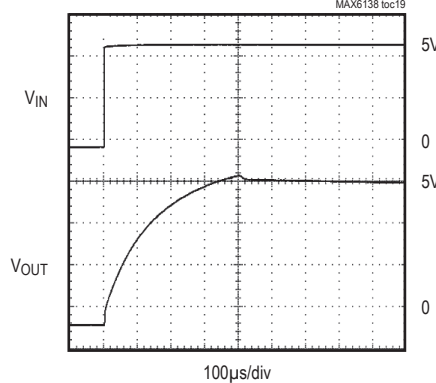

$I_{SHUNT} = 100\mu A$   
 $R_S = 16k\Omega$

MAX6138\_12  
OUTPUT IMPEDANCE vs. FREQUENCY

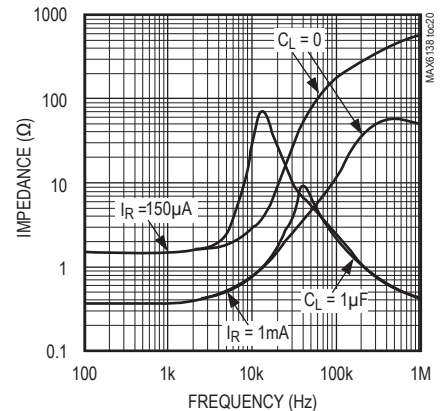

Typical Operating Characteristics (continued)

( $I_R = 100\mu A$ ,  $T_A = +25^\circ C$ , unless otherwise noted.)

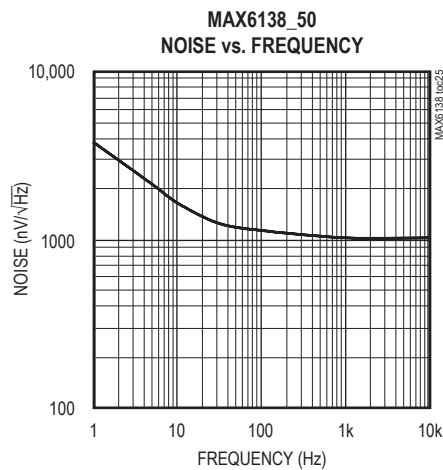
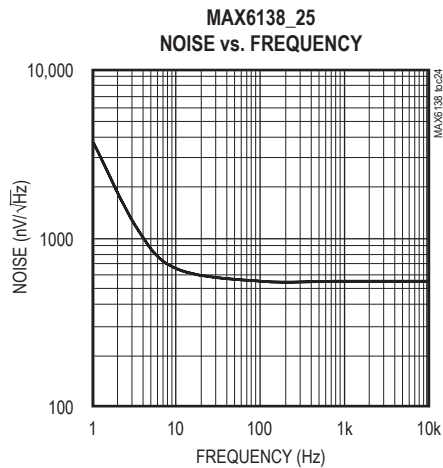
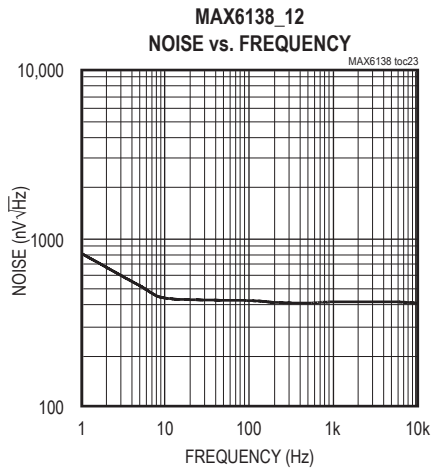
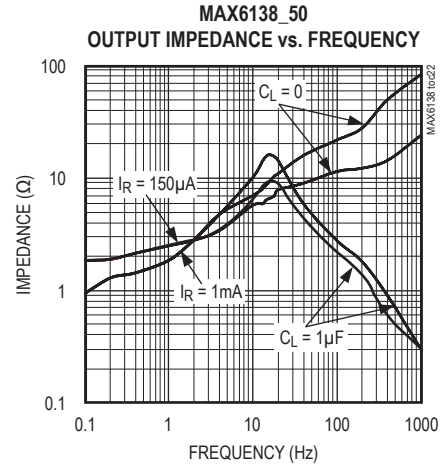
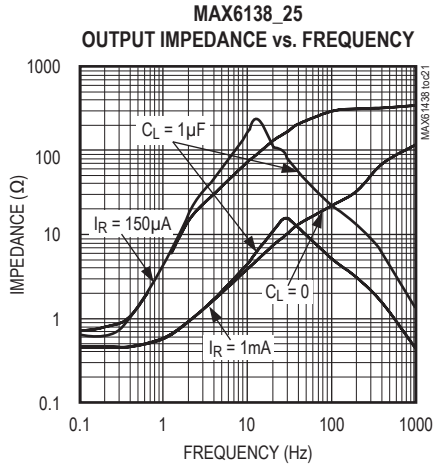

## Pin Description

PIN	NAME	FUNCTION
1	+	Positive Terminal of the Shunt Reference
2	-	Negative Terminal of the Shunt Reference
3	N.C.	No Connection. Leave this pin unconnected or connect to Pin 2.

## Detailed Description

The MAX6138 shunt reference uses the bandgap principle to produce a stable, accurate voltage. The device behaves similarly to an ideal zener diode; a fixed voltage is maintained across its output terminals when biased with 60µA to 15mA of reverse current. The MAX6138 behaves similarly to a silicon diode when biased with forward currents up to 10mA.

Figure 3 shows a typical operating circuit. The MAX6138 is ideal for providing a stable reference from a high-voltage power supply.

## Applications Information

The MAX6138's internal pass transistor is used to maintain a constant output voltage ( $V_{SHUNT}$ ) by sinking the necessary amount of current across a source resistor. The source resistance ( $R_S$ ) is determined from the load current ( $I_{LOAD}$ ) range, supply voltage ( $V_S$ ) variations,  $V_{SHUNT}$ , and desired quiescent current.

Choose the value of  $R_S$  when  $V_S$  is at a minimum and  $I_{LOAD}$  is at a maximum. Maintain a minimum  $I_{SHUNT}$  of 60µA at all times. The  $R_S$  value should be large enough to keep  $I_{SHUNT}$  less than 15mA for proper regulation when  $V_S$  is maximum and  $I_{LOAD}$  is at a minimum. To prevent damage to the device,  $I_{SHUNT}$  should never exceed 20mA.

Therefore, the value of  $R_S$  is bounded by the following equation:

$$[V_{S(MIN)} - V_R] / [60\mu A + I_{LOAD(MAX)}] > R_S > [V_{S(MAX)} - V_R] / [20mA + I_{LOAD(MIN)}]$$

Choosing a larger resistance minimizes the total power dissipation in the circuit by reducing the shunt current ( $P_{D(TOTAL)} = V_S \times I_{SHUNT}$ ). Provide a safety margin to incorporate the worst-case tolerance of the resistor used. Ensure that the resistor's power rating is adequate, using the following general power equation:

$$P_{DR} = I_{SHUNT} \times (V_{S(MAX)} - V_{SHUNT})$$

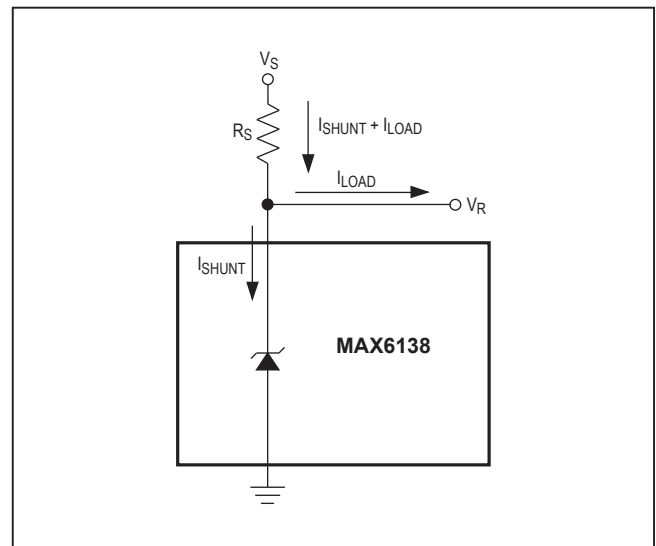

Figure 3. Typical Operating Circuit

## Output Capacitance

The MAX6138 does not require an external capacitor for operational stability and is stable for any output capacitance.

## Temperature Performance

The MAX6138 typically exhibits an output voltage temperature coefficient within  $\pm 4\text{ppm}/^\circ\text{C}$ . The polarity of the temperature coefficient may be different from one device to another; some may have positive coefficients, and others may have negative coefficients.

## Chip Information

TRANSISTOR COUNT: 70

PROCESS: BiCMOS

## Ordering Information

PART	OUTPUT VOLTAGE (V)	INITIAL ACCURACY (%)	TEMP RANGE	PIN-PACKAGE	TOP MARK
MAX6138AEXR12-T	1.2205	0.1	-40°C to +85°C	3 SC70-3	AEW
MAX6138BEXR12-T	1.2205	0.2	-40°C to +85°C	3 SC70-3	AEX
MAX6138CEXR12-T	1.2205	0.5	-40°C to +85°C	3 SC70-3	AEY
MAX6138AEXR21-T	2.0480	0.1	-40°C to +85°C	3 SC70-3	AFA
MAX6138BEXR21-T	2.0480	0.2	-40°C to +85°C	3 SC70-3	AFB
MAX6138CEXR21-T	2.0480	0.5	-40°C to +85°C	3 SC70-3	AFC
MAX6138AEXR25-T	2.5000	0.1	-40°C to +85°C	3 SC70-3	AFE
MAX6138BEXR25-T	2.5000	0.2	-40°C to +85°C	3 SC70-3	AFF
MAX6138CEXR25-T	2.5000	0.5	-40°C to +85°C	3 SC70-3	AFG
MAX6138AEXR30-T	3.0000	0.1	-40°C to +85°C	3 SC70-3	AFI
MAX6138BEXR30-T	3.0000	0.2	-40°C to +85°C	3 SC70-3	AFJ
MAX6138CEXR30-T	3.0000	0.5	-40°C to +85°C	3 SC70-3	AFK
MAX6138AEXR33-T	3.3000	0.1	-40°C to +85°C	3 SC70-3	ANG
MAX6138BEXR33-T	3.3000	0.2	-40°C to +85°C	3 SC70-3	ANH
MAX6138CEXR33-T	3.3000	0.5	-40°C to +85°C	3 SC70-3	ANI
MAX6138AEXR41-T	4.0960	0.1	-40°C to +85°C	3 SC70-3	AFM
MAX6138BEXR41-T	4.0960	0.2	-40°C to +85°C	3 SC70-3	AFN
MAX6138CEXR41-T	4.0960	0.5	-40°C to +85°C	3 SC70-3	AFO
MAX6138AEXR50-T	5.0000	0.1	-40°C to +85°C	3 SC70-3	AFQ
MAX6138BEXR50-T	5.0000	0.2	-40°C to +85°C	3 SC70-3	AFR
MAX6138CEXR50-T	5.0000	0.5	-40°C to +85°C	3 SC70-3	AFS

## Package Information

For the latest package outline information and land patterns (footprints), go to [www.maximintegrated.com/packages](http://www.maximintegrated.com/packages). Note that a "+", "#", or "-" in the package code indicates RoHS status only. Package drawings may show a different suffix character, but the drawing pertains to the package regardless of RoHS status.

PACKAGE TYPE	PACKAGE CODE	OUTLINE NO.	LAND PATTERN NO.
3 SC70	X3+2	<a href="#">21-0075</a>	<a href="#">90-0208</a>

MAX6138

0.1%, 25ppm, SC70 Shunt Voltage Reference  
with Multiple Reverse Breakdown Voltages

## Revision History

REVISION NUMBER	REVISION DATE	DESCRIPTION	PAGES CHANGED
3	12/19	Updated <i>Operating Temperature Range</i> in <i>Absolute Maximum Ratings</i>	2

For pricing, delivery, and ordering information, please visit Maxim Integrated's online storefront at <https://www.maximintegrated.com/en/storefront/storefront.html>.

*Maxim Integrated cannot assume responsibility for use of any circuitry other than circuitry entirely embodied in a Maxim Integrated product. No circuit patent licenses are implied. Maxim Integrated reserves the right to change the circuitry and specifications without notice at any time. The parametric values (min and max limits) shown in the Electrical Characteristics table are guaranteed. Other parametric values quoted in this data sheet are provided for guidance.*



Компания «ЭлектроПласт» предлагает заключение долгосрочных отношений при поставках импортных электронных компонентов на взаимовыгодных условиях!

Наши преимущества:

- Оперативные поставки широкого спектра электронных компонентов отечественного и импортного производства напрямую от производителей и с крупнейших мировых складов;
- Поставка более 17-ти миллионов наименований электронных компонентов;
- Поставка сложных, дефицитных, либо снятых с производства позиций;
- Оперативные сроки поставки под заказ (от 5 рабочих дней);
- Экспресс доставка в любую точку России;
- Техническая поддержка проекта, помощь в подборе аналогов, поставка прототипов;
- Система менеджмента качества сертифицирована по Международному стандарту ISO 9001;
- Лицензия ФСБ на осуществление работ с использованием сведений, составляющих государственную тайну;
- Поставка специализированных компонентов (Xilinx, Altera, Analog Devices, Intersil, Interpoint, Microsemi, Aeroflex, Peregrine, Syfer, Eurofarad, Texas Instrument, Miteq, Cobham, E2V, MA-COM, Hittite, Mini-Circuits, General Dynamics и др.);

Помимо этого, одним из направлений компании «ЭлектроПласт» является направление «Источники питания». Мы предлагаем Вам помощь Конструкторского отдела:

- Подбор оптимального решения, техническое обоснование при выборе компонента;
- Подбор аналогов;
- Консультации по применению компонента;
- Поставка образцов и прототипов;
- Техническая поддержка проекта;
- Защита от снятия компонента с производства.



#### Как с нами связаться

**Телефон:** 8 (812) 309 58 32 (многоканальный)

**Факс:** 8 (812) 320-02-42

**Электронная почта:** [org@eplast1.ru](mailto:org@eplast1.ru)

**Адрес:** 198099, г. Санкт-Петербург, ул. Калинина, дом 2, корпус 4, литера А.