

*ROHS COMPLIANT

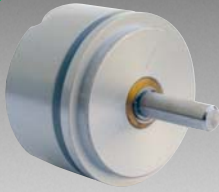

BOURNS®

Features

- Essentially infinite resolution
- Excellent rotational life
- High quality, rugged construction
- General purpose applications
- Non-standard features available
- Cost and space saving

6539/6639 - Precision Potentiometer

Electrical Characteristics ¹	6539 Servo Mount	6639 Bushing Mount
Standard Resistance Range.....	1 K to 100 K ohms.....	1 K to 100 K ohms
Total Resistance Tolerance.....	±15 %.....	±15 %
Independent Linearity.....	±2.0 %.....	±2.0 %
Effective Electrical Angle.....	340 ° +3 °.....	340 ° +3 °
End Voltage.....	0.5 % maximum.....	0.5 % maximum
Output Smoothness.....	0.1 %.....	0.1 %
Dielectric Withstanding Voltage (MIL-STD-202, Method 301)		
Sea Level.....	750 VAC minimum.....	750 VAC minimum
Power Rating (Voltage Limited By Power Dissipation or 300 VAC, Whichever is Less)		
+70 °C.....	1.0 watt.....	1.0 watt
+125 °C.....	0 watt.....	0 watt
Insulation Resistance (500 VDC).....	500 megohms minimum.....	500 megohms minimum
Resolution.....	Essentially infinite.....	Essentially infinite

Environmental Characteristics ¹	6539 Servo Mount	6639 Bushing Mount
Operating Temperature Range.....	+1 °C to +125 °C.....	-40 °C to +125 °C
Storage Temperature Range.....	-65 °C to +125 °C.....	-65 °C to +125 °C
Temperature Coefficient		
Over Storage Temperature Range.....	±500 ppm/°C maximum.....	±500 ppm/°C maximum
Vibration.....	15 G.....	15 G
Wiper Bounce.....	0.1 millisecond maximum.....	0.1 millisecond maximum
Total Resistance Shift.....	±10 %.....	±10 %
Voltage Ratio Shift.....	±0.5 %.....	±0.5 %
Shock.....	50 G.....	50 G
Wiper Bounce.....	0.1 millisecond maximum.....	0.1 millisecond maximum
Total Resistance Shift.....	±5 %.....	±5 %
Voltage Ratio Shift.....	±0.5 %.....	±0.5 %
Load Life.....	1,000 hours, 1 watt.....	1,000 hours, 1 watt
Total Resistance Shift.....	±10 %.....	±10 %
Rotational Life (No Load).....	10,000,000 shaft revolutions.....	10,000,000 shaft revolutions
Total Resistance Shift.....	±10 % maximum.....	±10 % maximum
Moisture Resistance (MIL-STD-202, Method 106)		
Total Resistance Shift.....	±15 %.....	±15 %
IP Rating.....	IP 40.....	IP 40

Mechanical Characteristics ¹	6539 Servo Mount	6639 Bushing Mount
Mechanical Angle.....	Continuous, Stops (340 ° +8 °, -0 °) available	
Torque (Starting & Running) ²	0.40 N-cm (0.5 oz.-in.) max.	
Mounting.....	170-200 N-cm (15-18 lb.-in.) maximum	
Shaft Runout.....	0.13 mm (0.005 in.) T.I.R.	
Lateral Runout.....	0.08 mm (0.003 in.) T.I.R.	
Shaft End Play.....	0.13 mm (0.005 in.) T.I.R.	
Shaft Radial Play.....	0.13 mm (0.005 in.) T.I.R.	
Pilot Diameter Runout.....	0.06 mm (0.0025 in.) T.I.R.	
Backlash.....	0.1 ° maximum	
Weight.....	18 gm (6539 Servo Mount), 24 gm (6639 Bushing Mount)	
Terminals.....	Rear Turret Type	
Soldering Condition		
Manual Soldering.....	96.5Sn/3.0Ag/0.5Cu solid wire or no-clean rosin cored wire 370 °C (700 °F) max. for 3 seconds	
Wave Soldering.....	96.5Sn/3.0Ag/0.5Cu solder with no-clean flux 260 °C (500 °F) max. for 5 seconds	
Wash processes.....	Not recommended	
Marking.....	Manufacturer's name and part number, resistance value and tolerance, linearity tolerance, wiring diagram, and date code.	
Ganging (Multiple Section Pots).....	1 cup maximum	
Hardware (6639 only).....	One lockwasher (H-37-2) and one mounting nut (H-38-2) is shipped with potentiometer.	

¹At room ambient: +25 °C nominal and 50 % relative humidity nominal, except as noted.
²2.82 N-cm (4.0 oz.-in.) max. at -40 °C.

Product Dimensions

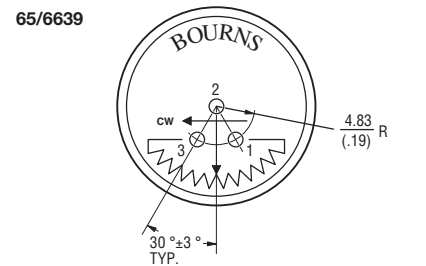
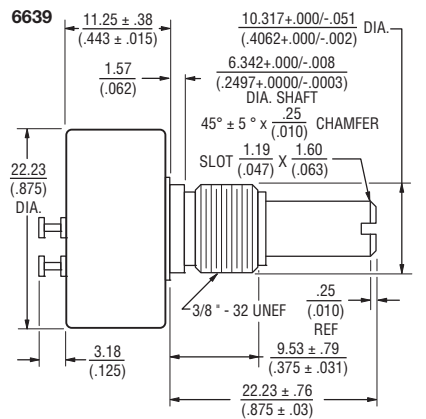
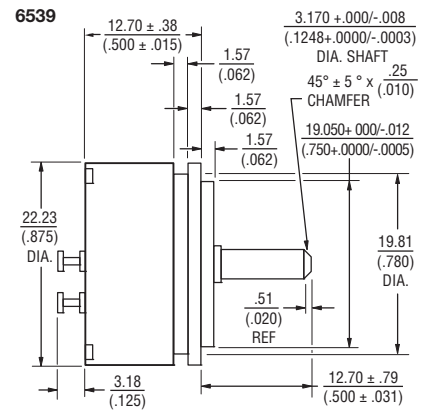

TOLERANCES: EXCEPT WHERE NOTED
 DECIMALS: .XX ± .01 .XXX ± .005
 FRACTIONS: ±1/64
 DIMENSIONS: MM (IN.)

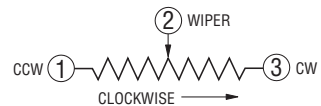

*RoHS Directive 2002/95/EC Jan. 27, 2003 including annex and RoHS Recast 2011/65/EU June 8, 2011.
 Specifications are subject to change without notice.
 The device characteristics and parameters in this data sheet can and do vary in different applications and actual device performance may vary over time.
 Users should verify actual device performance in their specific applications.

6539/6639 - Precision Potentiometer

BOURNS®

Recommended Part Numbers

Part Number	Resistance (Ω)
6539S-1-102	1,000
6539S-1-502	5,000
6539S-1-103	10,000

Part Numbers		Resistance (Ω)
Continuous Turn	Mechanical Stops	
6639S-1-102	6639S-301-102	1,000
6639S-1-202		2,000
6639S-1-502	6639S-301-502	5,000
6639S-1-103	6639S-301-103	10,000
6639S-1-203		20,000

BOLDFACE LISTINGS ARE IN STOCK AND READILY AVAILABLE THROUGH DISTRIBUTION. FOR OTHER OPTIONS CONSULT FACTORY.

Panel Thickness Dimensions

(For Bushing Mount Only)

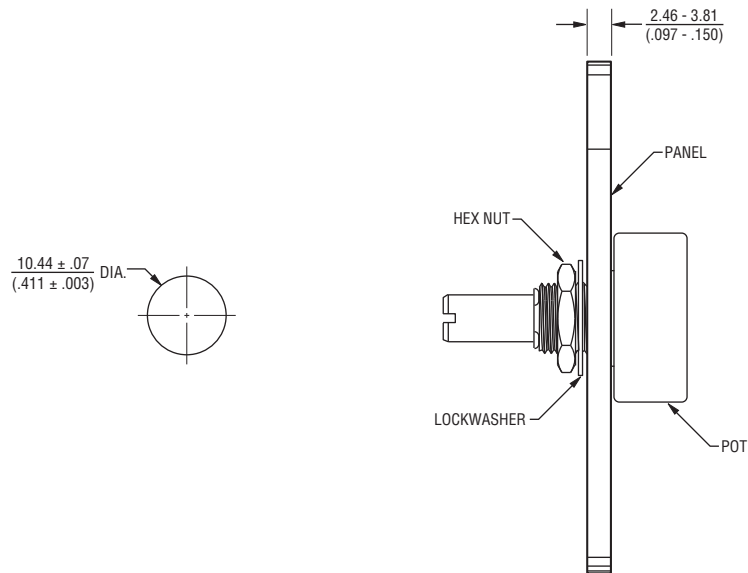

Panel thickness and hole diameters are recommended for best fit. However, customers may adjust the dimensions to suit their specific application.

DIMENSIONS: $\frac{\text{MM}}{\text{(INCHES)}}$ TOLERANCES: $\pm \frac{0.127}{(.005)}$

REV. 10/11

Specifications are subject to change without notice. The device characteristics and parameters in this data sheet can and do vary in different applications and actual device performance may vary over time. Users should verify actual device performance in their specific applications.



Компания «ЭлектроПласт» предлагает заключение долгосрочных отношений при поставках импортных электронных компонентов на взаимовыгодных условиях!

Наши преимущества:

- Оперативные поставки широкого спектра электронных компонентов отечественного и импортного производства напрямую от производителей и с крупнейших мировых складов;
- Поставка более 17-ти миллионов наименований электронных компонентов;
- Поставка сложных, дефицитных, либо снятых с производства позиций;
- Оперативные сроки поставки под заказ (от 5 рабочих дней);
- Экспресс доставка в любую точку России;
- Техническая поддержка проекта, помощь в подборе аналогов, поставка прототипов;
- Система менеджмента качества сертифицирована по Международному стандарту ISO 9001;
- Лицензия ФСБ на осуществление работ с использованием сведений, составляющих государственную тайну;
- Поставка специализированных компонентов (Xilinx, Altera, Analog Devices, Intersil, Interpoint, Microsemi, Aeroflex, Peregrine, Syfer, Eurofarad, Texas Instrument, Miteq, Cobham, E2V, MA-COM, Hittite, Mini-Circuits, General Dynamics и др.);

Помимо этого, одним из направлений компании «ЭлектроПласт» является направление «Источники питания». Мы предлагаем Вам помощь Конструкторского отдела:

- Подбор оптимального решения, техническое обоснование при выборе компонента;
- Подбор аналогов;
- Консультации по применению компонента;
- Поставка образцов и прототипов;
- Техническая поддержка проекта;
- Защита от снятия компонента с производства.



Как с нами связаться

Телефон: 8 (812) 309 58 32 (многоканальный)

Факс: 8 (812) 320-02-42

Электронная почта: org@eplast1.ru

Адрес: 198099, г. Санкт-Петербург, ул. Калинина, дом 2, корпус 4, литера А.