



Features

- Extremely high speed performance
- Blocks high voltages and currents
- Two TBU® protectors in one small package
- Simple, superior circuit protection
- Minimal PCB area
- RoHS compliant*, UL Recognized 



Bourns® Model P850-G Series TBU® HSPs are not recommended for POTS applications. This series is suited for applications requiring a dual bidirectional device where 50 ohms of series resistance is acceptable. For new SLIC applications, we recommend that customers evaluate our [TBU-PL Series](#).

P850-G Series Dual TBU® High-Speed Protectors

Transient Blocking Units - TBU® Devices

Bourns® Model P850-G TBU® products are dual high-speed bidirectional protection components, constructed using MOSFET semiconductor technology, designed to protect against faults caused by short circuits, AC power cross, induction and lightning surges.

The TBU® high speed protector, triggering as a function of the MOSFET, blocks surges and provides an effective barrier behind which sensitive electronics are not exposed to large voltages or currents during surge events. The TBU® device is provided in a surface mount DFN package and meets industry standard requirements such as RoHS and Pb Free solder reflow profiles.

Agency Approval

UL recognized component File # E315805.

Industry Standards

Description			Model
Telcordia	GR-1089	Port Type 3, 5	P850-G
ITU-T	K.20, K.20E, K.21, K.21E, K.45		P850-G

Absolute Maximum Ratings ($T_{amb} = 25\text{ }^{\circ}\text{C}$)

Symbol	Parameter	Value	Unit
V_{imp}	Maximum protection voltage for impulse faults with rise time $\geq 1\text{ }\mu\text{sec}$	850	V
V_{rms}	Maximum protection voltage for continuous V_{rms} faults	425	V
T_{op}	Operating temperature range	-40 to +85	$^{\circ}\text{C}$
T_{stg}	Storage temperature range	-65 to +150	$^{\circ}\text{C}$

Electrical Characteristics ($T_{amb} = 25\text{ }^{\circ}\text{C}$)

Symbol	Parameter	Model	Min.	Typ.	Max.	Unit
I_{op}	Maximum current through the device that will not cause current blocking	P850-G120-WH P850-G200-WH			100 200	mA
$I_{trigger}$	Typical current for the device to go from normal operating state to protected state	P850-G120-WH P850-G200-WH		150 275		mA
I_{out}	Maximum current through the device	P850-G120-WH P850-G200-WH			200 400	mA
R_{device}	Series resistance of the TBU® device			50	55	Ω
R_{bal}	Line-to line series resistance difference between two TBU® devices				2	Ω
t_{block}	Maximum time for the device to go from normal operating state to protected state				1	μs
$I_{quiescent}$	Current through the triggered TBU® device with 50 Vdc circuit voltage			0.7		mA
V_{reset}	Voltage below which the triggered TBU® device will transition to normal operating state			22		V

The P-G series TBU® devices are bidirectional; specifications are valid in both directions.



WARNING Cancer and Reproductive Harm
www.P65Warnings.ca.gov

*RoHS Directive 2002/95/EC Jan. 27, 2003 including annex and RoHS Recast 2011/65/EU June 8, 2011. Specifications are subject to change without notice. Users should verify actual device performance in their specific applications. The products described herein and this document are subject to specific legal disclaimers as set forth on the last page of this document, and at www.bourns.com/docs/legal/disclaimer.pdf.

Applications

- Sensor protection
- Signal line protection

P850-G Series Dual TBU® High-Speed Protectors

BOURNS®

Typical Performance Characteristics

V-I Characteristics

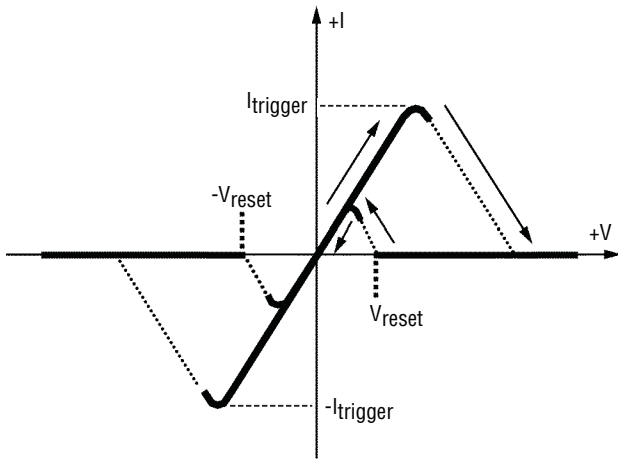

Time to Block vs. Fault Current

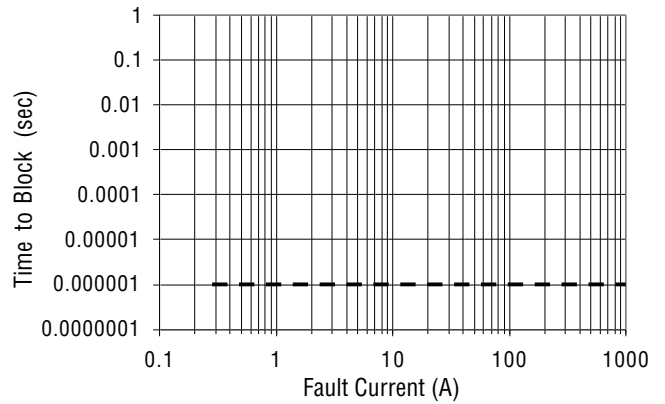

Trigger Current Temperature

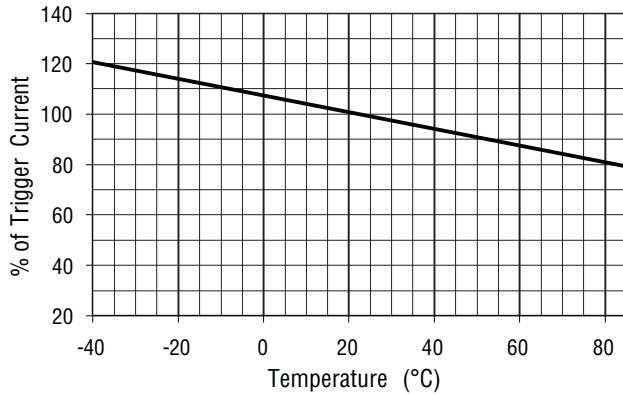

Specifications are subject to change without notice.

Users should verify actual device performance in their specific applications.

The products described herein and this document are subject to specific legal disclaimers as set forth on the last page of this document, and at www.bourns.com/docs/legal/disclaimer.pdf.

P850-G Series Dual TBU® High-Speed Protectors



Operational Characteristics

The graphs below demonstrate the operational characteristics of the TBU® device. For each graph the fault voltage, protected side voltage, and current is presented.

TEST CONFIGURATION DIAGRAM

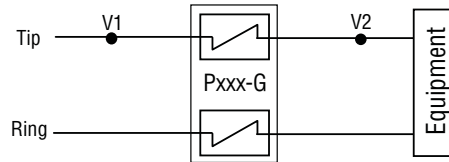

P850-G Lightning, 850 V

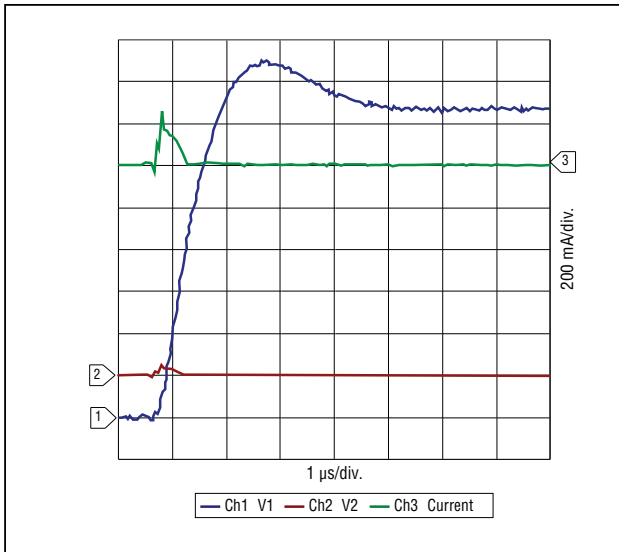

P850-G Power Fault, 230 Vrms, 25 A

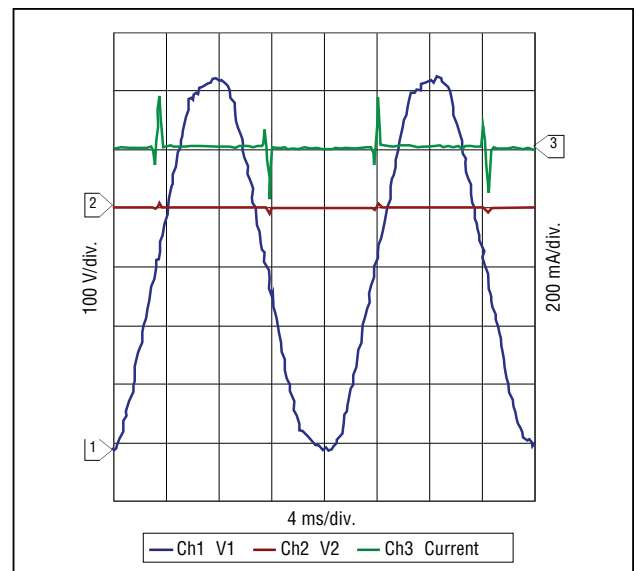

P850-G Series Dual TBU® High-Speed Protectors

BOURNS®

Product Dimensions

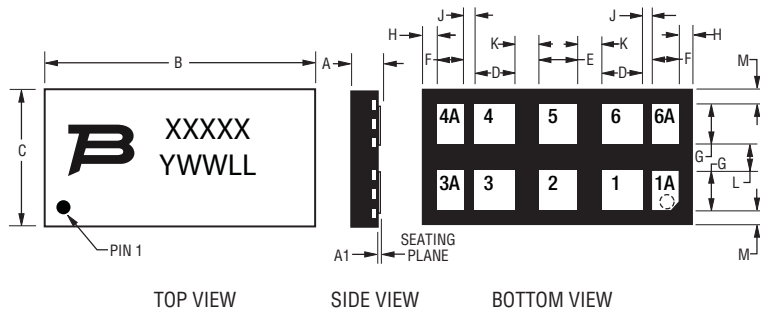

Pads 1A and 1 are internally connected; the same for pads 3A with 3, 4A with 4, and 6A with 6. This allows for one PCB layout to accommodate the Model P850.

Recommended Pad Layout

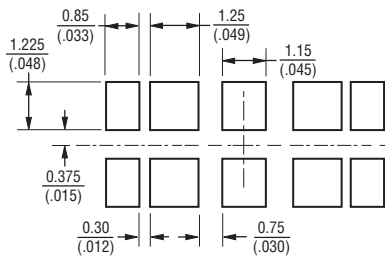

Pad Designation

Pad #	Apply	Pad #	Apply
1A	Tip In	4A	Ring Out
1	Tip In	4	Ring Out
2	NC	5	NC
3	Tip Out	6	Ring In
3A	Tip Out	6A	Ring In

NC = Solder to PCB; do not make electrical connection, do not connect to ground.

Dim.	P850-G		
	Min.	Typ.	Max.
A	0.80 (.031)	0.90 (.035)	1.00 (.039)
A1	0.00 (.000)	0.025 (.001)	0.05 (.002)
B	8.15 (.321)	8.25 (.325)	8.35 (.329)
C	3.90 (0.154)	4.00 (0.157)	4.10 (0.161)
D	1.15 (.045)	1.25 (.049)	1.35 (.053)
E	1.05 (.041)	1.15 (.045)	1.25 (.049)
F	0.725 (.029)	0.825 (.032)	0.925 (.036)
G	1.10 (.043)	1.20 (.047)	1.30 (.051)
H	0.375 (.015)	0.425 (.017)	0.475 (.019)
J	0.25 (.010)	0.30 (.012)	0.35 (.014)
K	0.70 (.028)	0.75 (.030)	0.80 (.031)
L	0.70 (.028)	0.75 (.030)	0.80 (.031)
M	0.375 (.015)	0.425 (.017)	0.475 (.018)

TBU® devices have matte-tin termination finish. Suggested layout should use non-solder mask define (NSMD). Recommended stencil thickness is 0.10-0.12 mm (.004-.005 in.) with stencil opening size 0.025 mm (.0010 in.) less than the device pad size. As when heat sinking any power device, it is recommended that, wherever possible, extra PCB copper area is allowed. For minimum parasitic capacitance, do not allow any signal, ground or power signals beneath any of the pads of the device.

DIMENSIONS: $\frac{\text{MM}}{\text{(INCHES)}}$

Thermal Resistances

Part #	Symbol	Parameter	Value	Unit
P850-G	Rth(j-a)	Junction to leads (package)	119	°C/W
		Junction to leads (per TBU® device)	215	°C/W

Block Diagram

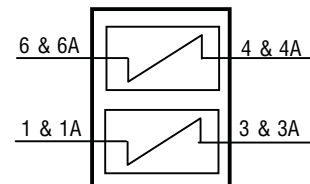

Reflow Profile

Profile Feature	Pb-Free Assembly
Average Ramp-Up Rate (T _{SMAX} to T _p)	3 °C/sec. max.
Preheat	
- Temperature Min. (T _{Smin})	150 °C
- Temperature Max. (T _{Smax})	200 °C
- Time (t _{Smin} to t _{Smax})	60-180 sec.
Time maintained above:	
- Temperature (T _L)	217 °C
- Time (t _L)	60-150 sec.
Peak/Classification Temperature (T _p)	260 °C
Time within 5 °C of Actual Peak Temp. (t _p)	20-40 sec.
Ramp-Down Rate	6 °C/sec. max.
Time 25 °C to Peak Temperature	8 min. max.

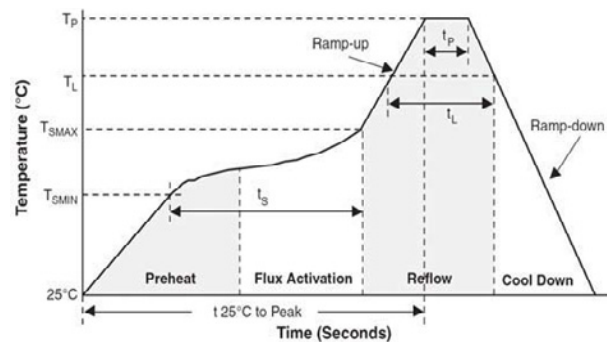

Specifications are subject to change without notice.

Users should verify actual device performance in their specific applications.

The products described herein and this document are subject to specific legal disclaimers as set forth on the last page of this document, and at www.bourns.com/docs/legal/disclaimer.pdf.

P850-G Series Dual TBU® High-Speed Protectors

BOURNS®

How to Order

P 850 - G 120 - WH

Form Factor _____
 P = Two TBUs® protectors in one device
 Impulse Voltage Rating _____
 850 = 850 V
 Directional Indication for Paired Devices _____
 G = Bidirectional
 Top Indicator _____
 120 = 100 mA
 200 = 200 mA

Typical Part Marking



5 DIGIT PRODUCT CODE:
 • 1ST DIGIT INDICATES PRODUCT FAMILY.
 8 = P850-G SERIES
 • 2ND & 3RD DIGITS INDICATE IMPULSE VOLTAGE.
 • 4TH & 5TH DIGITS INDICATE TRIGGER CURRENT.

MANUFACTURING DATE CODE:
 • 1ST DIGIT INDICATES THE YEAR.
 • 2ND & 3RD DIGITS INDICATE THE WEEK NUMBER.
 • 4TH & 5TH DIGITS INDICATE LOT CODE.

Packaging Specifications (per EIA468-B)

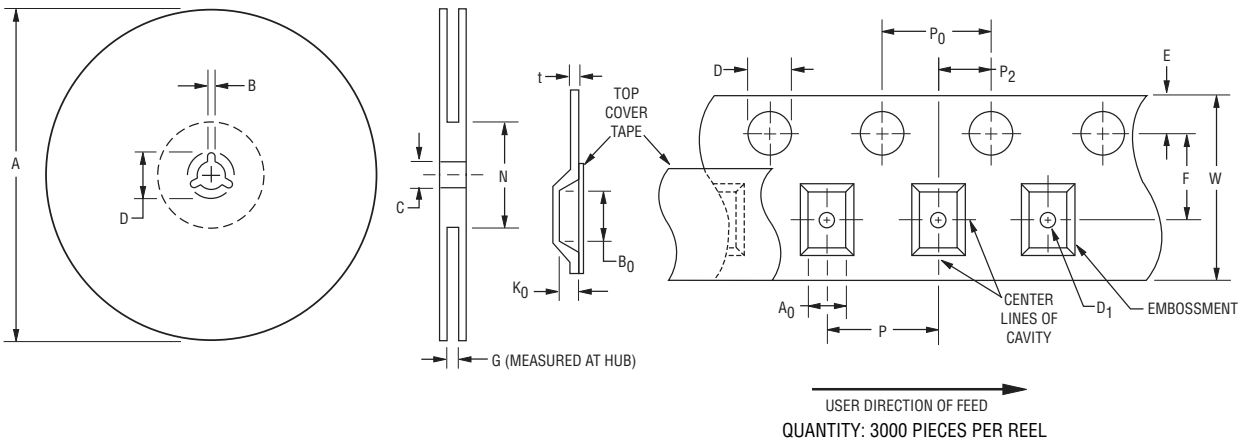

A		B		C		D		G	N
Min.	Max.	Min.	Max.	Min.	Max.	Min.	Max.	Ref.	Ref.
326	330.25	1.5	2.5	12.8	13.5	20.2	-	16.5	102
(12.835)	(13.002)	(.059)	(.098)	(.504)	(.531)	(.795)		(.650)	(4.016)

A ₀		B ₀		D		D ₁		E		F	
Min.	Max.	Min.	Max.	Min.	Max.	Min.	Max.	Min.	Max.	Min.	Max.
4.2	4.4	8.45	8.65	1.5	1.6	1.5	-	1.65	1.85	7.4	7.6
(.165)	(.173)	(.333)	(.341)	(.059)	(.063)	(.059)		(.065)	(.073)	(.291)	(.299)
K ₀		P		P ₀		P ₂		t		W	
Min.	Max.	Min.	Max.	Min.	Max.	Min.	Max.	Min.	Max.	Min.	Max.
1.1	1.3	7.9	8.1	3.9	4.1	1.9	2.1	0.25	0.35	15.7	16.3
(.043)	(.051)	(.311)	(.319)	(.159)	(.161)	(.075)	(.083)	(.010)	(.014)	(.618)	(.642)

DIMENSIONS: $\frac{\text{MM}}{\text{(INCHES)}}$

Specifications are subject to change without notice.
 Users should verify actual device performance in their specific applications.
 The products described herein and this document are subject to specific legal disclaimers as set forth on the last page of this document, and at www.bourns.com/docs/legal/disclaimer.pdf.

P850-G Series Dual TBU® High-Speed Protectors

BOURNS®

Reference Designs

A cost-effective protection solution combines the Bourns® TBU® protection device with a pair of MOVs or Bourns® GDTs and a diode bridge. The diagram below illustrates a common configuration of these components. The graphs to the right demonstrate the operational characteristics of the circuit.

For new SLIC applications, we recommend that customers evaluate our new TBU-PL series.

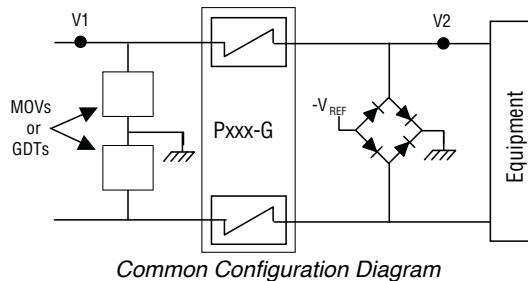

Common Configuration Diagram

P850-G Configuration (ITU-T K.20, K.21, K.20E, K.21E, K.45)			
Product	Qty.	Part Number	Source
TBU® Device	1	P850-G120-WH	Bourns, Inc.
MOV	2	MOV-10D361K	Bourns, Inc.
Diode bridge	2	GSD2004S-V MMBD2004S	Vishay Diodes Inc.

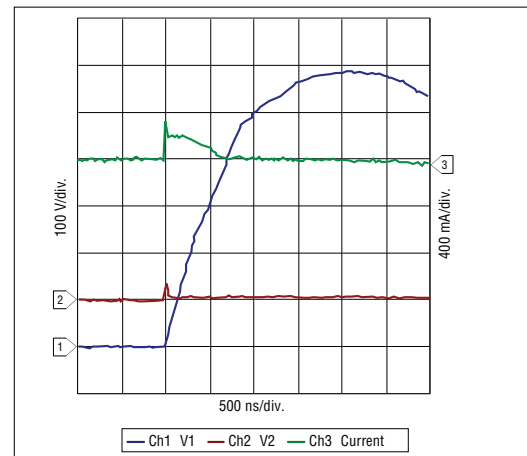

P850-G Solution: 4000 V Lightning 10/700 μsec, 100 A

BOURNS®

Asia-Pacific: Tel: +886-2 2562-4117 • Fax: +886-2 2562-4116

EMEA: Tel: +36 88 520 390 • Fax: +36 88 520 211

The Americas: Tel: +1-951 781-5500 • Fax: +1-951 781-5700

www.bourns.com

REV. 09/15

"TBU" is a registered trademark of Bourns, Inc. in the United States and other countries.

Specifications are subject to change without notice.

Users should verify actual device performance in their specific applications.

The products described herein and this document are subject to specific legal disclaimers as set forth on the last page of this document, and at www.bourns.com/docs/legal/disclaimer.pdf.

This legal disclaimer applies to purchasers and users of Bourns® products manufactured by or on behalf of Bourns, Inc. and its affiliates (collectively, “Bourns”).

Unless otherwise expressly indicated in writing, Bourns® products and data sheets relating thereto are subject to change without notice. Users should check for and obtain the latest relevant information and verify that such information is current and complete before placing orders for Bourns® products.

The characteristics and parameters of a Bourns® product set forth in its data sheet are based on laboratory conditions, and statements regarding the suitability of products for certain types of applications are based on Bourns’ knowledge of typical requirements in generic applications. The characteristics and parameters of a Bourns® product in a user application may vary from the data sheet characteristics and parameters due to (i) the combination of the Bourns® product with other components in the user’s application, or (ii) the environment of the user application itself. The characteristics and parameters of a Bourns® product also can and do vary in different applications and actual performance may vary over time. Users should always verify the actual performance of the Bourns® product in their specific devices and applications, and make their own independent judgments regarding the amount of additional test margin to design into their device or application to compensate for differences between laboratory and real world conditions.

Unless Bourns has explicitly designated an individual Bourns® product as meeting the requirements of a particular industry standard (e.g., ISO/TS 16949) or a particular qualification (e.g., UL listed or recognized), Bourns is not responsible for any failure of an individual Bourns® product to meet the requirements of such industry standard or particular qualification. Users of Bourns® products are responsible for ensuring compliance with safety-related requirements and standards applicable to their devices or applications.

Bourns® products are not recommended, authorized or intended for use in nuclear, lifesaving, life-critical or life-sustaining applications, nor in any other applications where failure or malfunction may result in personal injury, death, or severe property or environmental damage. Unless expressly and specifically approved in writing by two authorized Bourns representatives on a case-by-case basis, use of any Bourns® products in such unauthorized applications might not be safe and thus is at the user’s sole risk. Life-critical applications include devices identified by the U.S. Food and Drug Administration as Class III devices and generally equivalent classifications outside of the United States.

Bourns expressly identifies those Bourns® standard products that are suitable for use in automotive applications on such products’ data sheets in the section entitled “Applications.” Unless expressly and specifically approved in writing by two authorized Bourns representatives on a case-by-case basis, use of any other Bourns® standard products in an automotive application might not be safe and thus is not recommended, authorized or intended and is at the user’s sole risk. If Bourns expressly identifies a sub-category of automotive application in the data sheet for its standard products (such as infotainment or lighting), such identification means that Bourns has reviewed its standard product and has determined that if such Bourns® standard product is considered for potential use in automotive applications, it should only be used in such sub-category of automotive applications. Any reference to Bourns® standard product in the data sheet as compliant with the AEC-Q standard or “automotive grade” does not by itself mean that Bourns has approved such product for use in an automotive application.

Bourns® standard products are not tested to comply with United States Federal Aviation Administration standards generally or any other generally equivalent governmental organization standard applicable to products designed or manufactured for use in aircraft or space applications. Bourns expressly identifies Bourns® standard products that are suitable for use in aircraft or space applications on such products’ data sheets in the section entitled “Applications.” Unless expressly and specifically approved in writing by two authorized Bourns representatives on a case-by-case basis, use of any other Bourns® standard product in an aircraft or space application might not be safe and thus is not recommended, authorized or intended and is at the user’s sole risk.

The use and level of testing applicable to Bourns® custom products shall be negotiated on a case-by-case basis by Bourns and the user for which such Bourns® custom products are specially designed. Absent a written agreement between Bourns and the user regarding the use and level of such testing, the above provisions applicable to Bourns® standard products shall also apply to such Bourns® custom products.

Users shall not sell, transfer, export or re-export any Bourns® products or technology for use in activities which involve the design, development, production, use or stockpiling of nuclear, chemical or biological weapons or missiles, nor shall they use Bourns® products or technology in any facility which engages in activities relating to such devices. The foregoing restrictions apply to all uses and applications that violate national or international prohibitions, including embargos or international regulations. Further, Bourns® products and Bourns technology and technical data may not under any circumstance be exported or re-exported to countries subject to international sanctions or embargoes. Bourns® products may not, without prior authorization from Bourns and/or the U.S. Government, be resold, transferred, or re-exported to any party not eligible to receive U.S. commodities, software, and technical data.

To the maximum extent permitted by applicable law, Bourns disclaims (i) any and all liability for special, punitive, consequential, incidental or indirect damages or lost revenues or lost profits, and (ii) any and all implied warranties, including implied warranties of fitness for particular purpose, non-infringement and merchantability.

For your convenience, copies of this Legal Disclaimer Notice with German, Spanish, Japanese, Traditional Chinese and Simplified Chinese bilingual versions are available at:

Web Page: <http://www.bourns.com/legal/disclaimers-terms-and-policies>

PDF: <http://www.bourns.com/docs/Legal/disclaimer.pdf>



Компания «ЭлектроПласт» предлагает заключение долгосрочных отношений при поставках импортных электронных компонентов на взаимовыгодных условиях!

Наши преимущества:

- Оперативные поставки широкого спектра электронных компонентов отечественного и импортного производства напрямую от производителей и с крупнейших мировых складов;
- Поставка более 17-ти миллионов наименований электронных компонентов;
- Поставка сложных, дефицитных, либо снятых с производства позиций;
- Оперативные сроки поставки под заказ (от 5 рабочих дней);
- Экспресс доставка в любую точку России;
- Техническая поддержка проекта, помощь в подборе аналогов, поставка прототипов;
- Система менеджмента качества сертифицирована по Международному стандарту ISO 9001;
- Лицензия ФСБ на осуществление работ с использованием сведений, составляющих государственную тайну;
- Поставка специализированных компонентов (Xilinx, Altera, Analog Devices, Intersil, Interpoint, Microsemi, Aeroflex, Peregrine, Syfer, Eurofarad, Texas Instrument, Miteq, Cobham, E2V, MA-COM, Hittite, Mini-Circuits, General Dynamics и др.);

Помимо этого, одним из направлений компании «ЭлектроПласт» является направление «Источники питания». Мы предлагаем Вам помощь Конструкторского отдела:

- Подбор оптимального решения, техническое обоснование при выборе компонента;
- Подбор аналогов;
- Консультации по применению компонента;
- Поставка образцов и прототипов;
- Техническая поддержка проекта;
- Защита от снятия компонента с производства.



Как с нами связаться

Телефон: 8 (812) 309 58 32 (многоканальный)

Факс: 8 (812) 320-02-42

Электронная почта: org@eplast1.ru

Адрес: 198099, г. Санкт-Петербург, ул. Калинина, дом 2, корпус 4, литера А.