

### Features

- Formerly J.W. Miller® model
- High resistance to heat and humidity
- Resistance to mechanical shock and pressure
- Accurate dimensions for automatic surface mounting
- Wide inductance range (1.0 nH to 1000 µH)
- RoHS compliant\*

### Applications

- DC/DC converters
- Power supplies
- General use

## PM1210 & PM1812 Series SMT Chip Inductors

### General Specifications

Temperature Rise .....	20 °C max.
Ambient Temperature .....	80 °C max.
Operating Temperature.....	-40 °C to +100 °C
Storage Temperature.....	-40 °C to +100 °C
Resistance to Soldering Heat	
PM1210.....	260 °C, 5 seconds
PM1812.....	245 °C, 5 seconds

### Materials

Ferrite Core	
PM1210.....	All
PM1812.....	All
Coil Type.....	Copper wire
Enclosure.....	Epoxy resin
Terminal.....	Sn

### Product Dimensions

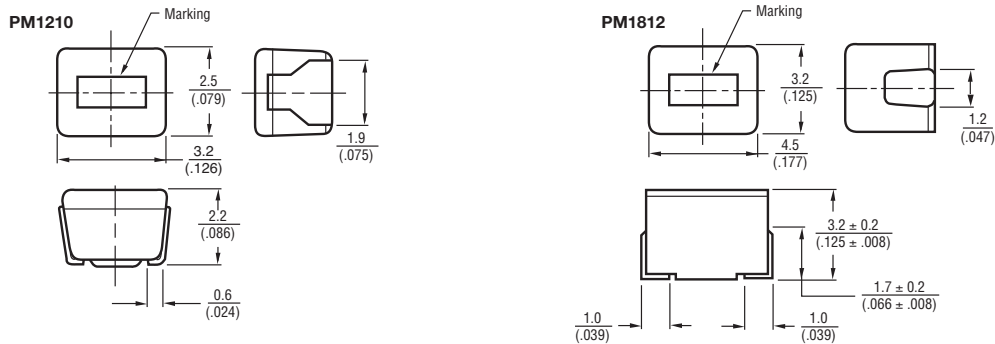

### Recommended Land Pattern Dimensions

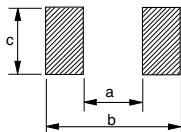

Model	a	b	c
PM1210	$\frac{1.6 \text{ to } 2.0}{(.063 \text{ to } .079)}$	$\frac{4.0 \text{ to } 4.6}{(.157 \text{ to } .181)}$	$\frac{1.9 \text{ to } 2.4}{(.075 \text{ to } .094)}$
PM1812	$\frac{2.4 \text{ to } 2.6}{(.094 \text{ to } .102)}$	$\frac{5.5 \text{ to } 6.0}{(.217 \text{ to } .236)}$	$\frac{2.0 \text{ to } 3.0}{(.079 \text{ to } .118)}$

DIMENSIONS:  $\frac{\text{MM}}{(\text{INCHES})}$

\*RoHS Directive 2002/95/EC Jan. 27, 2003 including annex and RoHS Recast 2011/65/EU June 8, 2011. Specifications are subject to change without notice. Customers should verify actual device performance in their specific applications.

# PM1210 & PM1812 Series SMT Chip Inductors

**BOURNS®**

## Packaging Specifications

### PM1210 Series

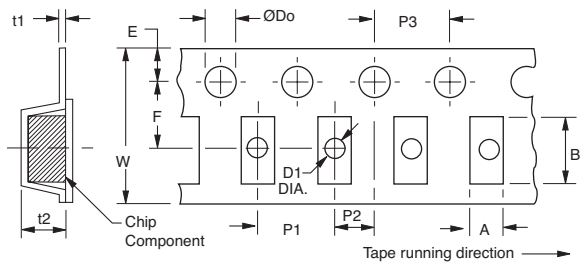

### PM1812 Series

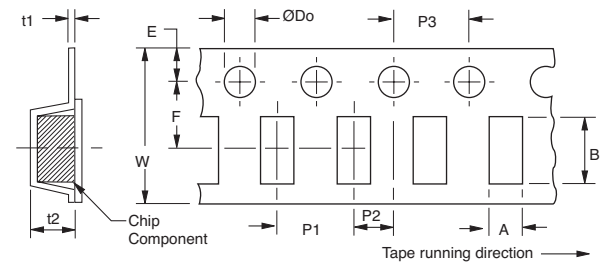

Model	A	B	W	F	E	P1	P2	P3	øD0	øD1	t1	t2
PM1210	2.80 (.110)	3.60 (.142)	8.00 (.315)	3.50 (.138)	1.75 (.069)	4.00 (.157)	2.00 (.079)	4.00 (.157)	1.50 (.059)	—	0.25 (.010)	2.40 (.094)
PM1812	3.60 (.142)	4.90 (.193)	12.00 (.472)	5.50 (.217)	1.75 (.069)	8.00 (.315)	2.00 (.079)	4.00 (.157)	1.50 (.059)	—	0.30 (.012)	3.50 (.138)

## Reel Dimensions

Model	A	B	C	D	E	W
PM1210	178 (7.008)	60 min.	13 (.512)	21 (.827)	2 (.079)	9 (.354)
PM1812	178 (7.008)	60 min.	13 (.512)	21 (.827)	2 (.079)	13 (.512)

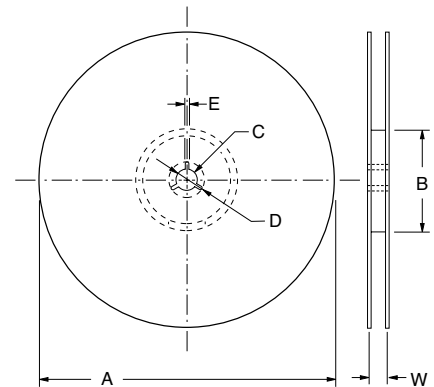

## Packaging

Model	Quantity	Weight
PM1210	2000 pcs.	190 g
PM1812	500 pcs.	100 g

DIMENSIONS:  $\frac{\text{MM}}{\text{(INCHES)}}$

## Soldering Profiles

### PM1210 Series

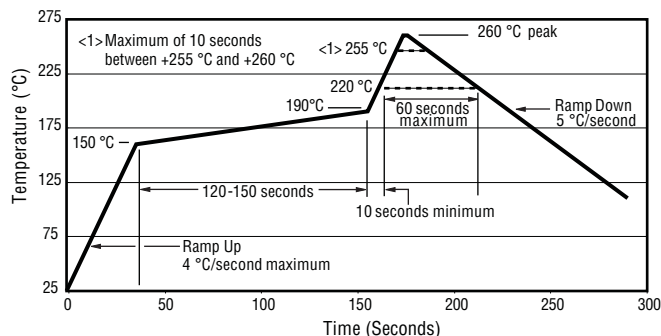

### PM1812 Series

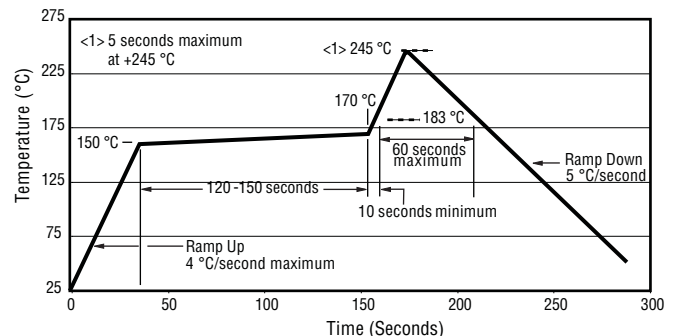

Specifications are subject to change without notice. Customers should verify actual device performance in their specific applications.

# PM1210 & PM1812 Series SMT Chip Inductors

**BOURNS®**

## PM1210 Series

RoHS Compliant 1210 Size Part Number	Inductance $\mu$ H	Tolerance	Q min.	Test Frequency MHz	SRF min. MHz	RDC ohms max.	IDC mA max.
PM1210-1R0J-RC	1.0	$\pm 5\%$	30	7.96	115	0.69	230
PM1210-1R2J-RC	1.2	$\pm 5\%$	30	7.96	100	0.75	215
PM1210-1R5J-RC	1.5	$\pm 5\%$	30	7.96	90	0.75	210
PM1210-1R8J-RC	1.8	$\pm 5\%$	30	7.96	85	0.82	200
PM1210-2R2J-RC	2.2	$\pm 5\%$	30	7.96	80	0.95	190
PM1210-2R7J-RC	2.7	$\pm 5\%$	30	7.96	75	1.1	180
PM1210-3R3J-RC	3.3	$\pm 5\%$	30	7.96	65	1.2	180
PM1210-3R9J-RC	3.9	$\pm 5\%$	30	7.96	60	1.3	175
PM1210-4R7J-RC	4.7	$\pm 5\%$	30	7.96	55	1.5	165
PM1210-5R6J-RC	5.6	$\pm 5\%$	30	7.96	50	1.6	160
PM1210-6R8J-RC	6.8	$\pm 5\%$	30	7.96	45	1.8	150
PM1210-8R2J-RC	8.2	$\pm 5\%$	30	7.96	40	2.0	140
PM1210-100J-RC	10	$\pm 5\%$	30	2.52	36	2.1	140
PM1210-120J-RC	12	$\pm 5\%$	30	2.52	33	2.5	125
PM1210-150J-RC	15	$\pm 5\%$	30	2.52	30	2.8	120
PM1210-180J-RC	18	$\pm 5\%$	30	2.52	27	3.3	110
PM1210-220J-RC	22	$\pm 5\%$	30	2.52	25	3.7	105
PM1210-270J-RC	27	$\pm 5\%$	30	2.52	22	5.0	90
PM1210-330J-RC	33	$\pm 5\%$	30	2.52	20	5.6	85
PM1210-390J-RC	39	$\pm 5\%$	30	2.52	20	6.4	80
PM1210-470J-RC	47	$\pm 5\%$	30	2.52	15	7.0	75
PM1210-560J-RC	56	$\pm 5\%$	30	2.52	15	8.0	70
PM1210-680J-RC	68	$\pm 5\%$	30	2.52	15	9.0	65
PM1210-820J-RC	82	$\pm 5\%$	30	2.52	11	10	60
PM1210-101J-RC	100	$\pm 5\%$	20	0.796	10	10	60
PM1210-121J-RC	120	$\pm 5\%$	20	0.796	10	11	55
PM1210-151J-RC	150	$\pm 5\%$	20	0.796	8	15	50
PM1210-181J-RC	180	$\pm 5\%$	20	0.796	7	17	50
PM1210-221J-RC	220	$\pm 5\%$	20	0.796	7	21	45

# PM1210 & PM1812 Series SMT Chip Inductors

# BOURNS®

## PM1812 Series

RoHS Compliant 1812 Size Part Number	Inductance $\mu$ H	Tolerance	Q min.	Test Freq. MHz	SRF min. MHz	RDC ohms max.	IDC mA max.
PM1812-R10K-RC	0.10	±10 %	35	25.2	300	0.18	800
PM1812-R12K-RC	0.12	±10 %	35	25.2	280	0.2	770
PM1812-R15K-RC	0.15	±10 %	35	25.2	250	0.22	730
PM1812-R18K-RC	0.18	±10 %	35	25.2	220	0.24	700
PM1812-R22K-RC	0.22	±10 %	40	25.2	200	0.25	665
PM1812-R27K-RC	0.27	±10 %	40	25.2	180	0.26	635
PM1812-R33K-RC	0.33	±10 %	40	25.2	165	0.28	605
PM1812-R39K-RC	0.39	±10 %	40	25.2	150	0.30	575
PM1812-R47K-RC	0.47	±10 %	40	25.2	145	0.32	545
PM1812-R56K-RC	0.56	±10 %	40	25.2	140	0.36	520
PM1812-R68K-RC	0.68	±10 %	40	25.2	135	0.40	500
PM1812-R82K-RC	0.82	±10 %	40	25.2	130	0.45	475
PM1812-1R0J-RC	1.0	±5 %	50	7.96	100	0.50	450
PM1812-1R2J-RC	1.2	±5 %	50	7.96	80	0.55	430
PM1812-1R5J-RC	1.5	±5 %	50	7.96	70	0.60	410
PM1812-1R8J-RC	1.8	±5 %	50	7.96	60	0.65	390
PM1812-2R2J-RC	2.2	±5 %	50	7.96	55	0.70	380
PM1812-2R7J-RC	2.7	±5 %	50	7.96	50	0.75	370
PM1812-3R3J-RC	3.3	±5 %	50	7.96	45	0.80	355
PM1812-3R9J-RC	3.9	±5 %	50	7.96	40	0.90	330
PM1812-4R7J-RC	4.7	±5 %	50	7.96	35	1.00	315
PM1812-5R6J-RC	5.6	±5 %	50	7.96	33	1.10	300
PM1812-6R8J-RC	6.8	±5 %	50	7.96	27	1.2	285
PM1812-8R2J-RC	8.2	±5 %	50	7.96	25	1.4	270
PM1812-100J-RC	10	±5 %	50	2.52	20	1.6	250
PM1812-120J-RC	12	±5 %	50	2.52	18	2	225
PM1812-150J-RC	15	±5 %	50	2.52	17	2.5	200
PM1812-180J-RC	18	±5 %	50	2.52	15	2.8	190
PM1812-220J-RC	22	±5 %	50	2.52	13	3.2	180
PM1812-270J-RC	27	±5 %	50	2.52	12	3.6	170
PM1812-330J-RC	33	±5 %	50	2.52	11	4	160
PM1812-390J-RC	39	±5 %	50	2.52	10	4.5	150
PM1812-470J-RC	47	±5 %	50	2.52	10	5	140
PM1812-560J-RC	56	±5 %	50	2.52	9	5.5	135
PM1812-680J-RC	68	±5 %	50	2.52	9	6	130
PM1812-820J-RC	82	±5 %	50	2.52	8	7	120
PM1812-101J-RC	100	±5 %	40	2.52	8	8	110
PM1812-121J-RC	120	±5 %	40	0.796	6	8	110
PM1812-151J-RC	150	±5 %	40	0.796	5	9	105
PM1812-181J-RC	180	±5 %	40	0.796	5	9.5	102
PM1812-221J-RC	220	±5 %	40	0.796	4	10	100
PM1812-271J-RC	270	±5 %	40	0.796	4	12	92
PM1812-331J-RC	330	±5 %	40	0.796	3.5	14	85
PM1812-391J-RC	390	±5 %	40	0.796	3	18	80
PM1812-471J-RC	470	±5 %	40	0.796	3	26	62
PM1812-561J-RC	560	±5 %	30	0.796	3	30	50
PM1812-681J-RC	680	±5 %	30	0.796	3	30	50
PM1812-821J-RC	820	±5 %	30	0.796	2.5	35	30
PM1812-102J-RC	1000	±5 %	30	0.252	2.5	40	30

REV. 07/10

Specifications are subject to change without notice.  
Customers should verify actual device performance in their specific applications.



Компания «ЭлектроПласт» предлагает заключение долгосрочных отношений при поставках импортных электронных компонентов на взаимовыгодных условиях!

Наши преимущества:

- Оперативные поставки широкого спектра электронных компонентов отечественного и импортного производства напрямую от производителей и с крупнейших мировых складов;
- Поставка более 17-ти миллионов наименований электронных компонентов;
- Поставка сложных, дефицитных, либо снятых с производства позиций;
- Оперативные сроки поставки под заказ (от 5 рабочих дней);
- Экспресс доставка в любую точку России;
- Техническая поддержка проекта, помощь в подборе аналогов, поставка прототипов;
- Система менеджмента качества сертифицирована по Международному стандарту ISO 9001;
- Лицензия ФСБ на осуществление работ с использованием сведений, составляющих государственную тайну;
- Поставка специализированных компонентов (Xilinx, Altera, Analog Devices, Intersil, Interpoint, Microsemi, Aeroflex, Peregrine, Syfer, Eurofarad, Texas Instrument, Miteq, Cobham, E2V, MA-COM, Hittite, Mini-Circuits, General Dynamics и др.);

Помимо этого, одним из направлений компании «ЭлектроПласт» является направление «Источники питания». Мы предлагаем Вам помощь Конструкторского отдела:

- Подбор оптимального решения, техническое обоснование при выборе компонента;
- Подбор аналогов;
- Консультации по применению компонента;
- Поставка образцов и прототипов;
- Техническая поддержка проекта;
- Защита от снятия компонента с производства.



#### Как с нами связаться

**Телефон:** 8 (812) 309 58 32 (многоканальный)

**Факс:** 8 (812) 320-02-42

**Электронная почта:** [org@eplast1.ru](mailto:org@eplast1.ru)

**Адрес:** 198099, г. Санкт-Петербург, ул. Калинина, дом 2, корпус 4, литера А.