

IB IL AO 2/UI-XC-PAC

Inline analog output terminal, version for extreme conditions, 2 outputs for connection of current and voltage signals

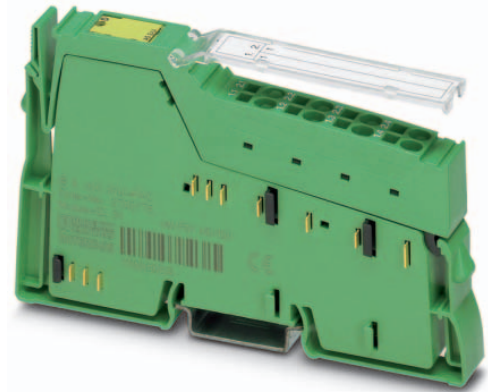

Data sheet
8500_en_02

© PHOENIX CONTACT 2015-11-04

1 Description

The terminal is designed for use within an Inline station.

It is used to output analog current or voltage signals.

Thanks to special engineering measures and tests, the terminal can be used under extreme ambient conditions.

Features

- 2 analog output channels
- Connection of actuators in 2-wire technology
- Current ranges: 0 mA ... 20 mA, 4 mA ... 20 mA, ± 20 mA
- Voltage ranges: 0 V ... 10 V, -10 V ... +10 V
- Diagnostic and status indicators
- Can be used under extreme ambient conditions
- Extended temperature range of -40°C ... +70°C (see "Tested successfully: use under extreme ambient conditions")
- Painted PCBs



This data sheet is only valid in association with the IL SYS INST UM E user manual.



Make sure you always use the latest documentation.
It can be downloaded from the product at phoenixcontact.net/products.

2	Table of contents	
1	Description	1
2	Table of contents	2
3	Ordering data	3
4	Technical data	4
5	Additional technical data.....	7
5.1	Tolerance specifications	7
5.2	Step response (signal rise time)	7
5.3	Tolerances influenced by electromagnetic interference	7
6	Tested successfully: Use under extreme ambient conditions	8
7	Internal circuit diagram	9
8	Electrical isolation.....	9
9	Terminal point assignment.....	10
10	Connection example.....	10
11	Connection notes	10
12	Installation instructions	10
13	Local status and diagnostic indicators	10
14	Process data.....	11
14.1	OUT process data.....	11
14.2	IN process data	12
14.3	Read firmware version	12
15	Representation of the output values in the different formats	13
15.1	IB IL format	13
15.2	Format S7 compatible.....	14

3 Ordering data

Description	Type	Order No.	Pcs./Pkt.
Inline analog output terminal, version for extreme conditions, complete with accessories (connector connector and labeling field), 2 outputs, 0 - 20 mA, 4 - 20 mA, ± 20 mA, 0 - 10 V, ± 10 V, 2-conductor connection technology	IB IL AO 2/UI-XC-PAC	2701389	1
Accessories	Type	Order No.	Pcs./Pkt.
Shield connection clamp, for shield on busbars, contact resistance < 1 m Ω (Assembly)	SK 8	3025163	10
Shield connection clamp, for shield on busbars, contact resistance < 1 m Ω (Assembly)	SK 14	3025176	10
Shield connection clamp, for shield on busbars, contact resistance < 1 m Ω (Assembly)	SK 20	3025189	10
Shield connection clamp, for shield on busbars, contact resistance < 1 m Ω (Assembly)	SK 35	3026463	10
Support bracket for busbars (Assembly)	AB-SK	3025341	10
Support bracket, Bracket for busbars, set every 20 cm, Length: 95.5 mm, Width: 6.2 mm, Color: gray (Assembly)	AB-SK 65	3026489	10
Support bracket, Bracket for busbars, set every 20 cm, Length: 10 mm, Width: 56 mm, Height: 20 mm, Color: silver (Assembly)	AB-SK/E	3026476	10
PEN conductor busbar, 3mm x 10 mm, length: 1000 mm (Assembly)	NLS-CU 3/10 SN 1000MM	0402174	10
Connection terminal block, Connection method Screw connection, Cross section: 0.5 mm ² - 6 mm ² , Width: 7 mm, Color: silver	AK 4	0404017	50
Connection terminal block, Connection method Screw connection, Cross section: 0.5 mm ² - 6 mm ² , Width: 7 mm, Color: green-yellow	AKG 4 GNYE	0421029	50
Connection terminal block, Connection method Screw connection, Cross section: 0.5 mm ² - 6 mm ² , Width: 7 mm, Color: black	AKG 4 BK	0421032	50
Documentation	Type	Order No.	Pcs./Pkt.
User manual, English, Automation terminals of the Inline product range	IL SYS INST UM E	-	-
Data sheet, English, INTERBUS addressing	DB GB IBS SYS ADDRESS	-	-

4 Technical data

Dimensions (nominal sizes in mm)

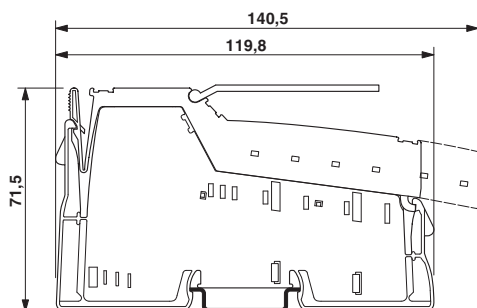

Width	12.2 mm
Height	119.8 mm
Depth	71.5 mm
Note on dimensions	Housing dimensions

General data

Weight	66 g (with connector)
Ambient temperature (operation)	-25 °C ... 55 °C (Standard) -40 °C ... 70 °C (Extended, see section "Tested successfully: use under extreme ambient conditions" in the data sheet.)
Ambient temperature (storage/transport)	-40 °C ... 85 °C
Permissible humidity (operation)	10 % ... 95 % (according to DIN EN 61131-2)
Permissible humidity (storage/transport)	10 % ... 95 % (according to DIN EN 61131-2)
Air pressure (operation)	70 kPa ... 106 kPa (up to 3000 m above sea level)
Air pressure (storage/transport)	70 kPa ... 106 kPa (up to 3000 m above sea level)
Degree of protection	IP20
Protection class	III, IEC 61140, EN 61140, VDE 0140-1

Connection data

Designation	Inline connector
Connection method	Spring-cage connection
Conductor cross section solid / stranded	0.08 mm ² ... 1.5 mm ² / 0.08 mm ² ... 1.5 mm ²
Conductor cross section [AWG]	28 ... 16
Stripping length	8 mm

Connection data for UL approvals

Designation	Inline connector
Connection method	Spring-cage connection
Conductor cross section solid / stranded	0.2 mm ² ... 1.5 mm ² / 0.2 mm ² ... 1.5 mm ²
Conductor cross section [AWG]	24 ... 16
Stripping length	8 mm

Interface Inline local bus

Number	2
Connection method	Inline data jumper
Transmission speed	500 kBit/s
Transmission physics	Copper

Inline potentials / Power consumption

Communications power U_L	7.5 V DC (via voltage jumper)
Current consumption from U_L	typ. 55 mA max. 65 mA
I/O supply voltage U_{ANA}	24 V DC
Current consumption from U_{ANA}	typ. 24 mA (No-load) max. 30 mA (No-load) typ. 38 mA (Nominal voltage load ($U_{OUT1/2} = 10\text{ V}$, $R_L = 1\text{ k}\Omega$)) max. 45 mA (Nominal voltage load ($U_{OUT1/2} = 10\text{ V}$, $R_L = 1\text{ k}\Omega$)) typ. 65 mA (Nominal current load ($I_{OUT1/2} = 20\text{ mA}$, $R_L = 0\text{ }\Omega$)) max. 75 mA (Nominal current load ($I_{OUT1/2} = 20\text{ mA}$, $R_L = 0\text{ }\Omega$))
Power consumption	typ. 1.32 W (Nominal voltage load ($U_{OUT1/2} = 10\text{ V}$, $R_L = 1\text{ k}\Omega$)) typ. 1.97 W (Nominal current load ($I_{OUT1/2} = 20\text{ mA}$, $R_L = 0\text{ }\Omega$))

Analog outputs

Number of outputs	2
Connection method	2-wire (shielded, twisted pair)
D/A resolution	12 bit
D/A conversion time	typ. 10 μs
Representation of output values	12 bits (11 bits + sign bit)
Data formats	IB IL, S7-compatible
Process data update	bus-synchronous
Permissible cable length	max. 250 m (The specifications refer to nominal operation after complying with installation instructions. The specifications refer to the following reference cable type: Shielded power station cable: LiYCY; 2 x 2 x 0,5 mm ² ; VDE0812)
Short-circuit and overload protection	Electronic
Transient protection	Suppressor diode

Analog outputs, Current

Current output signal	0 mA ... 20 mA, 4 mA ... 20 mA, -20 mA ... 20 mA
Load/output load current output	$\leq 450\text{ }\Omega$
Precision	typ. 0.1 % (of output range final value)

Analog outputs, Voltage

Voltage output signal	0 V ... 10 V, -10 V ... 10 V
Load/output load voltage output	$> 1\text{ k}\Omega$
Precision	typ. 0.1 % (of output range final value)

Programming Data

ID code (hex)	5B
ID code (dec.)	91
Length code (hex)	04
Length code (dec.)	04
Process data channel	64 Bit
Input address area	8 Byte
Output address area	8 Byte
Parameter channel (PCP)	0 Byte
Register length (bus)	64 Bit

Configuration and parameter data in a PROFIBUS system

Required parameter data	10 Byte
Need for configuration data	5 Byte

Error messages to the higher level control or computer system

Failure of the internal I/O supply	I/O error message sent to the bus coupler
I/O supply failure	Message in the diagnostic code (in the IB IL format)
Short circuit/overload of the outputs	Message in the diagnostic code (in the IB IL format)
Configuration invalid	Message in the diagnostic code (in the IB IL format)

Electrical isolation/isolation of the voltage areas**Test section****Test voltage**

7.5 V supply (bus logics)/24 V analog supply (analog I/O)	500 V AC, 50 Hz, 1 min
7.5 V supply (bus logics) / functional earth ground	500 V AC, 50 Hz, 1 min
24 V analog supply (analog I/O) / functional earth ground	500 V AC, 50 Hz, 1 min



To achieve electrical isolation between the logic level and the I/O area, supply these areas from separate power supply units. Interconnection of the power supply units in the 24 V area is not permitted (see also user manual).

Conformance with EMC Directive 2004/108/EC**Noise immunity test in accordance with EN 61000-6-2**

Electrostatic discharge (ESD) EN 61000-4-2/IEC 61000-4-2	Criterion B; 6 kV contact discharge, 8 kV air discharge
Electromagnetic fields EN 61000-4-3/IEC 61000-4-3	Criterion A; Field intensity: 10 V/m
Fast transients (burst) EN 61000-4-4/IEC 61000-4-4	Criterion B, 2 kV
Transient surge voltage (surge) EN 61000-4-5/IEC 61000-4-5	Criterion B; DC: ± 0.5 kV/ ± 1 kV(symmetrical/unsymmetrical) supply cables; shielded I/O cables: ± 1 kV
Conducted interference EN 61000-4-6/IEC 61000-4-6	Criterion A; Test voltage 10 V

Noise emission test according to EN 61000-6-3

Radio interference properties EN 55022	Class A
--	---------

Approvals

For the latest approvals, please visit phoenixcontact.net/products.

5 Additional technical data

5.1 Tolerance specifications

Tolerances at $T_A = +25^\circ\text{C}$				
Output range	Absolute		Relative	
	Typ.	Max.	Typ.	Max.
0 V ... 10 V, ± 10 V	± 10 mV	± 20 mV	± 0.1 %	± 0.2 %
0 mA ... 20 mA, 4 mA ... 20 mA, ± 20 mA	± 20 μA	± 60 μA	± 0.1 %	± 0.3 %

The typical specifications contain the typical offset, gain and linearity errors.

All tolerances indicated as a percentage are related to the positive output range final value.

The data is valid for nominal operation ($U_{\text{ANA}} = 24$ V) in the default configuration.

Default configuration: IB IL format

Please also observe the values for the temperature drift.

The maximum tolerance values represent the worst case measurement inaccuracy. Besides maximum offset and gain drift, they also comprise longtime drift as well as the maximum tolerances of the test and calibration equipment.

Tolerance and temperature response at $T_A = -25^\circ\text{C} \dots +55^\circ\text{C}$		
Output range	Drift	
	Typ.	Max.
0 V ... 10 V, ± 10 V	± 30 ppm/K	± 50 ppm/K
0 mA ... 20 mA, 4 mA ... 20 mA, ± 20 mA	± 30 ppm/K	± 50 ppm/K

The drift values refer to the relevant output range final value.

The values refer to nominal operation with default settings.

5.2 Step response (signal rise time)

Voltage step 0 V ... 10 V (typical values)

Load	Time for 10 % ... 90 %	Time for 0 % ... 99 %
$R_L = 2$ k Ω	9 μs	15 μs
$R_L = 2$ k Ω $C_L = 10$ nF	9 μs	15 μs
$R_L = 2$ k Ω $C_L = 220$ nF	135 μs	180 μs
$R_L = 2$ k Ω + $L_L = 3$ mH	8 μs	15 μs

Current step 0 mA ... 20 mA (typical values)

Load	Time for 10 % ... 90 %	Time for 0 % ... 99 %
$R_L = 500$ Ω	3 μs	5 μs
$R_L = 500$ Ω $C_L = 10$ nF	18 μs	30 μs
$R_L = 500$ Ω $C_L = 220$ nF	300 μs	590 μs
$R_L = 500$ Ω + $L_L = 3$ mH	1.6 μs	3 μs
$R_L = 50$ Ω $C_L = 100$ μF	11 μs	27 μs

Current step 4 mA ... 20 mA (typical specifications)

Load	Time for 10 % ... 90 %	Time for 0 % ... 99 %
$R_L = 500$ Ω	2.3 μs	4 μs
$R_L = 500$ Ω $C_L = 10$ nF	15 μs	26 μs
$R_L = 500$ Ω $C_L = 220$ nF	260 μs	450 μs
$R_L = 500$ Ω + $L_L = 3$ mH	1.5 μs	2.8 μs

5.3 Tolerances influenced by electromagnetic interference

Type of electromagnetic interference	Typical deviation in % referencing the output range final value	
	Voltage output	Current output
Electromagnetic fields; field strength 10 V/m according to EN 61000-4-3/IEC 61000-4-3	< 1 %	< 1 %
Conducted interference, Class 3 (10 V test voltage) according to EN 61000-4-6/IEC 61000-4-6	< 1 %	< 1.2 %
Fast transients (burst) up to an interference voltage of ± 2.2 kV in acc. with EN 61000-4-4 / IEC 61000-4-4	< 1 %	< 2 %

6 Tested successfully: Use under extreme ambient conditions

XC terminals have been tested successfully over 250 temperature change cycles in accordance with IEC 61131-2 in the range from -40°C to +70°C.

The following conditions were observed:

- The Inline devices for all connecting cables were connected with a minimum conductor cross section of 0.5 mm²
- The Inline station was assembled on a wall-mounted horizontal DIN rail
- Fans were used to ensure continuous movement of air in the control cabinet
- The Inline station was not exposed to vibration or shock
- The Inline station was operated with a maximum of 24.5 V (ensured by using regulated power supply units)

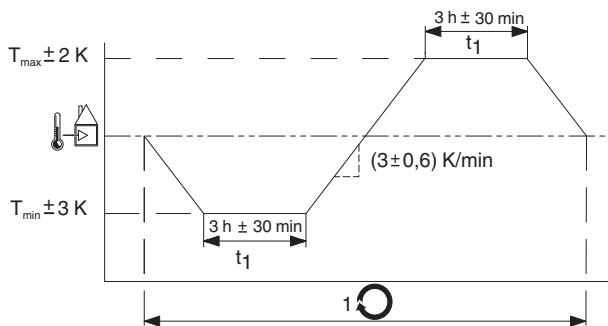

Figure 1 Temperature change cycle



Temperature in the control cabinet/ambient temperature



Cycle



WARNING:

The terminal is not approved for use in potentially explosive areas.

The terminal is not approved for use in safety technology.

7 Internal circuit diagram

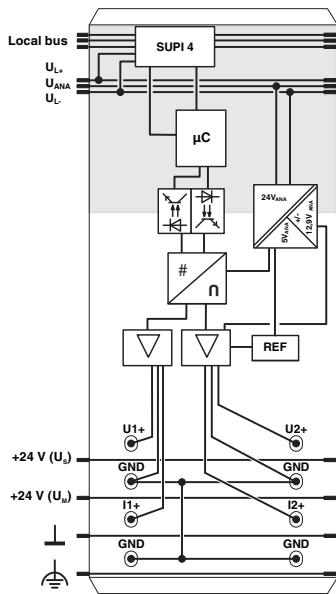











Figure 2 Internal wiring of the terminal points

Key:

	Protocol chip
	Microprocessor
	Optocoupler
	Power supply unit with electrical isolation
	Digital/analog converter
	Output amplifier
	Electrically isolated area
	Reference voltage source

 Explanation for other used symbols has been provided in the IL SYS INST UM E user manual.

8 Electrical isolation

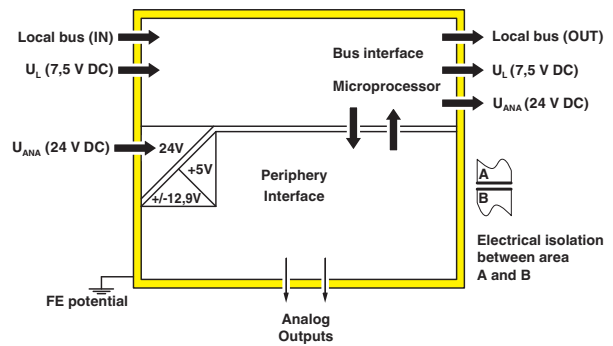

Figure 3 Electrical isolation of the individual function areas

9 Terminal point assignment

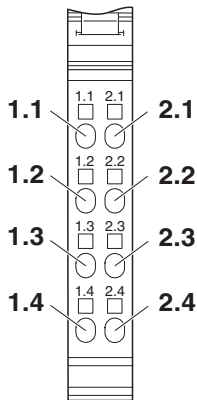

Figure 4 Terminal point assignment

Terminal point	Signal	Meaning
1.1	+U1	Positive voltage connection for channel 1
1.2	AGND	Analog ground
1.3	+I1	Positive current connection for channel 1
1.4	AGND	Analog ground
2.1	+U2	Positive voltage connection for channel 2
2.2	AGND	Analog ground
2.3	+I2	Positive current connection for channel 2
2.4	AGND	Analog ground

10 Connection example

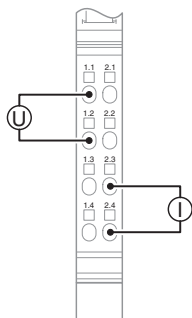

Figure 5 Connection for voltage and current output

11 Connection notes

Always connect the analog actuators using shielded twisted-pair cables.

Connect the shielding with the shielding accessories given in the ordering data.

Insulate the shielding at the actuator or connect it with a high resistance and capacitance to the PE potential.

12 Installation instructions

High current flowing through potential jumpers U_M and U_S leads to a temperature rise in the potential jumpers and inside the terminal. To keep the current flowing through the potential jumpers of the analog terminals as low as possible, always place the analog terminals after all the other terminals at the end of the main circuit (for the sequence of the In-line terminals: see also IL SYS INST UM E user manual).

13 Local status and diagnostic indicators



Figure 6 Local status and diagnostic indicators

Designation	Color	Meaning
D	green	Diagnostics (bus and logic voltage)



For detailed information on diagnostics, please refer to the IL SYS INST UM E user manual.

Function identification

Yellow

14.2 IN process data

The following data is transmitted in the input process data:

- During normal error-free operation, the configuration and the output value are mirrored in the input process data.
- If an error occurs, the mirrored configuration and the diagnostics message (in IB IL format) are mapped in the input process data for each channel.
- If the firmware version is to be read out, the firmware is mapped in word 1.

Order of the process data words

IN1	IN2	IN3	IN4
Channel 1	Channel 2	Channel 1	Channel 2
Conf*	Conf*	AW*/Diag	AW*/Diag

Conf* Mirrored configuration word
 AW*/Diag Mirrored output value or diagnostics messages (in IB IL format)

Mirrored configuration word

15	14	13	12	11	10	9	8	7	6	5	4	3	2	1	0
EB	0	0	0	0	0	0	0	0	0	0	0	0	0	0	0
												Format		Output range	

EB Error
 EB = 0 No error has occurred.
 EB = 1 An error has occurred.

Mirrored output value or diagnostics messages (in IB IL format)

15	14	13	12	11	10	9	8	7	6	5	4	3	2	1	0	
V													X	X	X	X

V Sign bit
 X Not relevant bit

14.3 Read firmware version

OUT1																
Bit	15	14	13	12	11	10	9	8	7	6	5	4	3	2	1	0
Assignment (hex)	3				C				0				0			
Meaning	Read firmware version															

To read the firmware version, transmit the value 3C00_{hex} in the output data word OUT1.

During enquiry of the firmware version, the first channel is deactivated and it is also not possible to change the configuration of the first channel.

The output data words OUT2 and OUT4 keep their meaning. The second channel is active and can also be configured.

The firmware version is contained in the IN1 input data word. The input data words IN2 to IN4 keep their meaning.

IN1 (example)																
Bit	15	14	13	12	11	10	9	8	7	6	5	4	3	2	1	0
Assignment (hex)	1				2				3				4			
Meaning	Firmware version 1.23												Device ID			

The device ID allows you to distinguish between two devices with the same programming data (ID code, length code).

Inline terminal	ID code	Length code	Device ID
IB IL AO 2/UI-XC-PAC	5B _{hex}	04 _{hex}	4

15 Representation of the output values in the different formats

15.1 IB IL format

Output data		0 V ... 10 V	-10 V ... +10 V
hex	dec	V	V
8001	Measuring range exceeded (over-range)	10.837	10.837
7F00	32512	10.837	10.837
7530	30000	10.0	10.0
0010	16	0.00533	0.00533
0000	0	0	0
FFF0	-16	-	-0.00533
8AD0	-30000	-	-10.0
8100	-32512	-	-10.837
8080	Below measuring range (underrange)	-	-10.837
8002	Open circuit	-	-

Output data		0 mA ... 20 mA	-20 mA ... +20 mA	4 mA ... 20 mA
hex	dec	mA	mA	mA
8001	Measuring range exceeded (over-range)	21.675	21.675	21.339
7F00	32512	21.675	21.675	21.339
7530	30000	20.000	20.000	20.000
0010	16	0.010667	0.010667	4.008533
0000	0	0	0	4.0
FFF0	-16	-	-0.010677	-
8AD0	-30000	-	-20.0	-
8100	-32512	-	-21.675	-
8080	Below measuring range (underrange)	-	-21.675	-
8002	Open circuit	-	-	4.0

In the IB IL format a diagnostic code is mapped to the input data in the event of an error.

Code (hex)	Cause	
8002	Open circuit	The output is configured as current output and the set current cannot flow.
8003	Short-circuit/overload of the output.	The output is configured as voltage output and is short circuited.
8010	Configuration invalid	
8020	Faulty supply voltage	Periphery supply voltage
8040	Device faulty	

15.2 Format S7 compatible

Output data		0 V ... 10 V	-10 V ... +10 V
hex	dec	V	V
7FFF	Measuring range exceeded (over-range)	11.754	11.754
7EF0	32496	11.754	11.754
6C00	27648	10.0	10.0
0010	16	0.00579	0.00579
0000	0	0	0
FFF0	-16	-	-0.00579
9400	-27648	-	-10.0
8100	-32512	-	-11.754
8000	Below measuring range (underrange)	-	-11.754

Output data		0 mA ... 20 mA	-20 mA ... +20 mA	4 mA ... 20 mA
hex	dec	mA	mA	mA
7FFF	Measuring range exceeded (over-range)	23.507	23.507	22.805
7EF0	32496	23.507	23.507	22.805
6C00	27648	20.000	20.000	20.000
0010	16	0.011574	0.011574	4.009259
0000	0	0	0	4.0
FFF0	-16	-	-0.011574	-
8AD0	-30000	-	-20.0	-
8100	-32512	-	-23.507	-
8000	Below measuring range (underrange)	-	-23.507	-
	Open circuit	-	-	4.0

In S7-compatible format, error code 8010_{hex} is mapped to the input data in the event of a "Configuration invalid" error.

In the event of any other error, code 8000_{hex} is sent.



Компания «ЭлектроПласт» предлагает заключение долгосрочных отношений при поставках импортных электронных компонентов на взаимовыгодных условиях!

Наши преимущества:

- Оперативные поставки широкого спектра электронных компонентов отечественного и импортного производства напрямую от производителей и с крупнейших мировых складов;
- Поставка более 17-ти миллионов наименований электронных компонентов;
- Поставка сложных, дефицитных, либо снятых с производства позиций;
- Оперативные сроки поставки под заказ (от 5 рабочих дней);
- Экспресс доставка в любую точку России;
- Техническая поддержка проекта, помощь в подборе аналогов, поставка прототипов;
- Система менеджмента качества сертифицирована по Международному стандарту ISO 9001;
- Лицензия ФСБ на осуществление работ с использованием сведений, составляющих государственную тайну;
- Поставка специализированных компонентов (Xilinx, Altera, Analog Devices, Intersil, Interpoint, Microsemi, Aeroflex, Peregrine, Syfer, Eurofarad, Texas Instrument, Miteq, Cobham, E2V, MA-COM, Hittite, Mini-Circuits, General Dynamics и др.);

Помимо этого, одним из направлений компании «ЭлектроПласт» является направление «Источники питания». Мы предлагаем Вам помощь Конструкторского отдела:

- Подбор оптимального решения, техническое обоснование при выборе компонента;
- Подбор аналогов;
- Консультации по применению компонента;
- Поставка образцов и прототипов;
- Техническая поддержка проекта;
- Защита от снятия компонента с производства.



Как с нами связаться

Телефон: 8 (812) 309 58 32 (многоканальный)

Факс: 8 (812) 320-02-42

Электронная почта: org@eplast1.ru

Адрес: 198099, г. Санкт-Петербург, ул. Калинина, дом 2, корпус 4, литера А.