

EAO – Your Expert Partner for  
**Human Machine Interfaces**

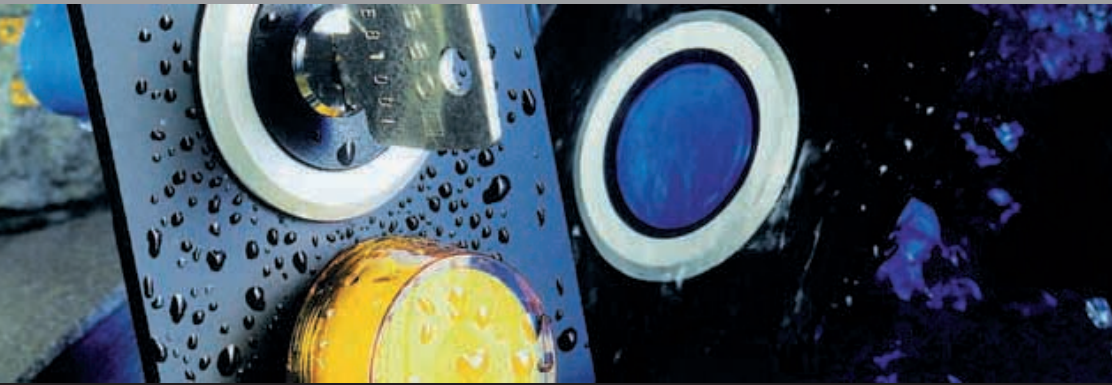

## EAO Product Information

Series 14



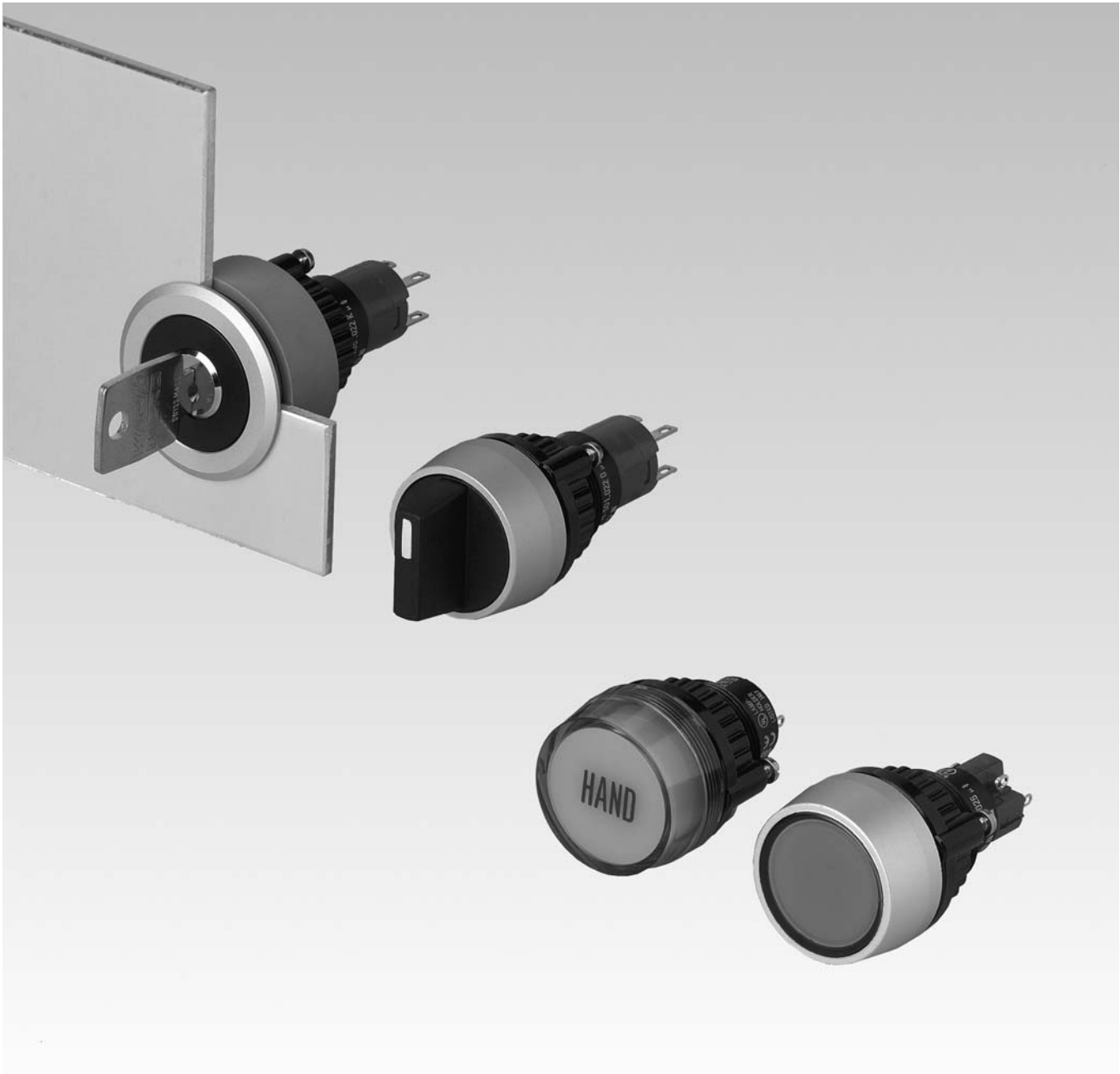

Description .....	3
Product Assembly .....	4
Devices raised mounting .....	6
Devices flush mounting .....	13
Accessories.....	17
Technical Data.....	27
Typical Applications .....	30
Application guidelines.....	31
Marking .....	32
Drawings.....	36
Index.....	56

## Product Information

### General notes

The Series 14 illuminated pushbuttons combine the robust actuators of the Series 04 with choice of either snap-action switching elements with gold plated silver contacts for one changeover only.

These pushbuttons have an IP 67 proof front (temporary emersion) and can be immersed to a depth of one metre.

The range includes pushbuttons, keylock switches and selector switches.

Anodized aluminium parts can have visible variations due production-technical reasons.

### Mounting

Mounted from the front through either 22.5 mm dia cut out for raised or 30.5 mm dia for flush.

The pushbuttons are secured to the panel by means of a fixing ring/ nut and prevented from twisting by two screws.

To ensure correct positioning of the pushbuttons we can provide a positioning insert if required.

The Low Level switching elements with universal terminals allow them to PCB mounted. These terminals are also suitable for dip soldering. A plug-in base is available, which when soldered to the board allows the switch to be easily plugged-in.

### Lenses

Lenses of transparent plastic or aluminium are available in various standard colours.

### Marking

For further information about engraving, hot stamping and film inserts see part Marking.

### Illumination

The T5.5 incandescent (filament) lamp (6, 12, 24, 28, 30, 36, 48 V) ensures perfect illumination of the lenses, which are supplied in various colours.

T5.5 Single-Chip LED (6, 12, 24, 28, 48 V) are also available in blue, green, red, white or yellow.

Do not solder the terminals directly, because of the high surface temperature.

Luminosity and wave length scattering caused by the technology used in the LED manufacturing processes may lead to visual differences in our products.

### Position indication

The status of a maintained action switch can be determined by the position of the lens.

### Keylock switch

Single locks (2 positions).

There are 10 different locks with standard numbers 1001 ... 1010. If the lock number is not specified, we will supply standard number 1001.

Additional lock numbers are available on request.

Two keys are supplied with each keylock switch.

Spare keys for standard locks may be ordered by quoting Typ-Nr.

14-987 (please state the lock number).

## Specimen order

### Illuminated pushbutton :

- Illuminated pushbutton actuator, 29 mm dia., snap-action switching element, 1NC + 1 NO, momentary action, soldering terminal 14-131.0252

### Essential accessories :

- Lens plastic red 704.602.2
- Marking plate white translucent 704.609.9
- Front ring aluminium natural 704.600.1
- Single-LED, T5.5, 12 VAC/DC, white 10-2109.1069

*We reserve the right to modify technical data  
All dimensions in mm*

## Illuminated pushbutton, raised mounting

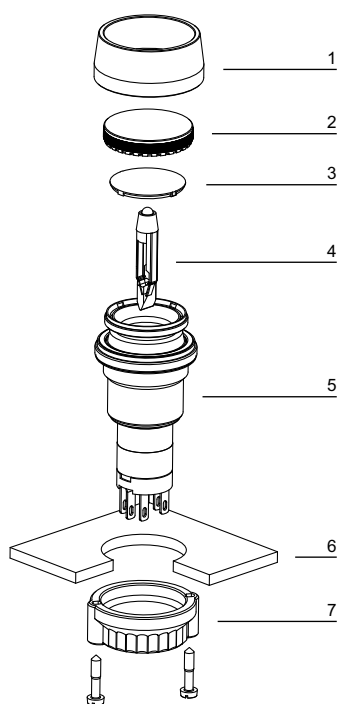

- 1 Front ring
- 2 Lens
- 3 Marking plate
- 4 LED
- 5 Actuator housing with switching element
- 6 Front plate
- 7 Fixing nut

## Illuminated pushbutton, flush mounting

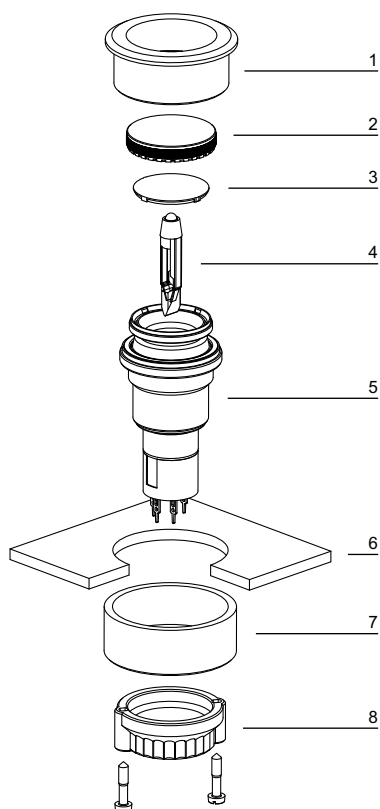

- 1 Front bezel set, flush mounting
- 2 Lens
- 3 Marking plate
- 4 LED
- 5 Actuator housing with switching element
- 6 Front panel
- 7 Pressure ring
- 8 Fixing nut

## Keylock switch, raised mounting

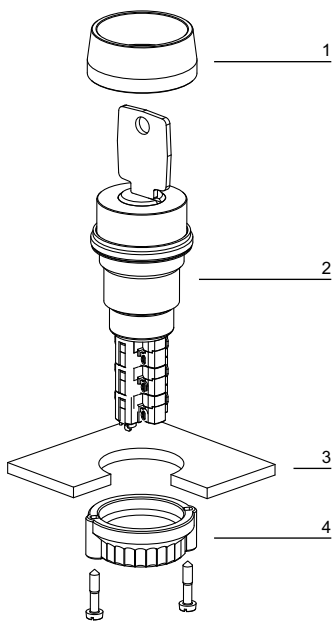

- 1 Front ring
- 2 Actuator housing with switching element
- 3 Front plate
- 4 Fixing nut

## Selector switch, flush mounting

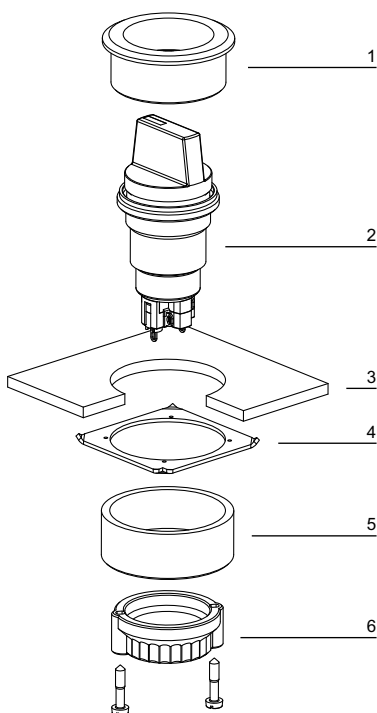

- 1 Front ring
- 2 Actuator housing with switching element
- 3 Front plate
- 4 Anti-twist ring
- 5 Pressure ring
- 6 Fixing nut

## Indicator actuator full face illumination



### Essential Accessories:

- Lens cap page 18
- Marking cap for Lens cap page 19
- Single-LED page 24

	Front protection	Diode (1N 4007)	Terminals	Ø 29 mm Typ-Nr.	Component layout	Mounting dimensions	Technical drawing	Circuit drawing	
<b>Indicator actuator full face illumination</b>	IP 67	1 D	UT	<b>14-741.006</b>	2	5	17	56	0.011
		2 D	UT	<b>14-742.006</b>	2	5	17	57	0.011
	-	S		<b>14-030.005</b>		5	17	3	0.010
		S1		<b>14-030.002</b>		5	17	3	0.010
		UT		<b>14-031.006</b>	2	5	17	2	0.011

Diode (1N 4007): D = Diode, - = without

Terminals: UT = Universal terminal, S = Soldering terminal, S1 = Soldering terminal (also pluggable 2.8 x 0.5 mm)

Component layout from page 36, Mounting dimensions from page 37, Technical drawing from page 38, Circuit drawing from page 48

## Indicator actuator front illumination



### Essential Accessories:

- Front ring page 19
- Lens plastic page 17
- Marking plate for Lens plastic and metal page 18
- Single-LED page 24

	Front protection	Terminals	Ø 29 mm Typ-Nr.	Component layout	Mounting dimensions	Technical drawing	Circuit drawing	
<b>Indicator actuator front illumination</b>	IP 67	S	<b>14-040.005</b>		5	19	3	0.050
		S1	<b>14-040.002</b>		5	19	3	0.050
		UT	<b>14-041.006</b>	2	5	19	2	0.050

Terminals: S = Soldering terminal, S1 = Soldering terminal (also pluggable 2.8 x 0.5 mm), UT = Universal terminal

Component layout from page 36, Mounting dimensions from page 37, Technical drawing from page 38, Circuit drawing from page 48



## Buzzer



	Front protection	Front cap	Terminals	Ø 29 mm Typ-Nr.	Mounting dimensions	Technical drawing	Circuit drawing	
<b>Buzzer</b> Operation voltage 24 VDC	IP 65	Brass nickel-plated	S1	<b>14-810.902</b>	5	1	1	0.016
		Plastic black	S1	<b>14-810.002</b>	5	1	1	0.016

Further information in the Technical Data and Typical Applications

Terminals: S1 = Soldering terminal (also pluggable 2.8 x 0.5 mm)

Mounting dimensions from page 37, Technical drawing from page 38, Circuit drawing from page 48

## Illuminated actuator pushbutton



### Essential Accessories:

- Front ring page 19
- Lens plastic page 17
- Marking plate for Lens plastic and metal page 18
- Single-LED page 24

	Front protection	Switching system	Contacts	Diode (1N 4007)	Switching action	Terminals	Ø 29 mm Typ-Nr.	Component layout	Mounting dimensions	Technical drawing	Circuit drawing		
<b>Illuminated actuator pushbutton</b>	IP 67	LL	1 NC	-	MA	UT	<b>14-476.036</b>	2	5	20	12	0.015	
					M	UT	<b>14-436.036</b>	2	5	20	39	0.015	
			1 NC + 1 NO	-	MA	UT	<b>14-473.036</b>	2	5	20	15	0.015	
					M	UT	<b>14-433.036</b>	2	5	20	42	0.015	
			1 NO	-	MA	UT	<b>14-475.036</b>	2	5	20	14	0.015	
					M	UT	<b>14-435.036</b>	2	5	20	41	0.015	
			2 NC	-	MA	UT	<b>14-472.036</b>	2	5	20	13	0.015	
					M	UT	<b>14-432.036</b>	2	5	20	40	0.015	
			2 NO	-	MA	UT	<b>14-471.036</b>	2	5	20	16	0.015	
					M	UT	<b>14-431.036</b>	2	5	20	43	0.015	
			SA	1 NC + 1 NO	1 D	MA	UT	<b>14-747.0292</b>	2	5	20	9	0.014
						M	UT	<b>14-743.0292</b>	2	5	20	36	0.014
		2 D			MA	UT	<b>14-748.0292</b>	2	5	20	10	0.014	
					M	UT	<b>14-744.0292</b>	2	5	20	37	0.014	
		-			MA	S	<b>14-271.0252</b>		5	20	11	0.013	
					S1	<b>14-271.022</b>		5	20	11	0.013		
		M		S	<b>14-131.0252</b>		5	20	38	0.013			
				S1	<b>14-131.022</b>		5	20	38	0.013			
		2 NC + 2 NO		1 D	MA	UT	<b>14-749.0292</b>	2	5	20	6	0.016	
					M	UT	<b>14-745.0292</b>	2	5	20	33	0.016	
				2 D	MA	UT	<b>14-750.0292</b>	2	5	20	7	0.016	
					M	UT	<b>14-746.0292</b>	2	5	20	34	0.016	
		-	MA	S	<b>14-272.0252</b>		5	20	8	0.015			
			M	S	<b>14-132.0252</b>		5	20	35	0.015			
3 NC + 3 NO	-	MA	S	<b>14-273.0252</b>		5	20	5	0.017				
		M	S	<b>14-133.0252</b>		5	20	32	0.017				
4 NC + 4 NO	-	MA	S	<b>14-274.0252</b>		5	20	4	0.019				
		M	S	<b>14-134.0252</b>		5	20	31	0.019				

Switching system: LL = Low level switching element, SA = Snap-action switching element

Contacts: NC = Normally closed, NO = Normally open

Diode (1N 4007): - = without, D = Diode

Switching action: MA = Maintained action, M = Momentary action



Terminals: UT = Universal terminal, S = Soldering terminal, S1 = Soldering terminal (also pluggable 2.8 x 0.5 mm)

Component layout from page 36, Mounting dimensions from page 37, Technical drawing from page 38, Circuit drawing from page 48

## Mushroom-head actuator pushbutton



### Essential Accessories:

-  Front ring page 19
-  Marking plate for Mushroom-head cap page 18
-  Mushroom-head cap page 18

	Front protection	Switching system	Contacts	Switching action	Terminals	Ø 40 mm Typ-Nr.	Component layout	Mounting dimensions	Technical drawing	Circuit drawing		
<b>Mushroom-head actuator pushbutton</b>	IP 67	LL	1 NC	MA	UT	<b>14-476.036</b>	2	2	18	12	0.015	
				M	UT	<b>14-436.036</b>	2	2	18	39	0.015	
			1 NC + 1 NO	MA	UT	<b>14-473.036</b>	2	2	18	15	0.015	
				M	UT	<b>14-433.036</b>	2	2	18	42	0.015	
			1 NO	MA	UT	<b>14-475.036</b>	2	2	18	14	0.015	
				M	UT	<b>14-435.036</b>	2	2	18	41	0.015	
			2 NC	MA	UT	<b>14-472.036</b>	2	2	18	13	0.015	
				M	UT	<b>14-432.036</b>	2	2	18	40	0.015	
			2 NO	MA	UT	<b>14-471.036</b>	2	2	18	16	0.015	
				M	UT	<b>14-431.036</b>	2	2	18	43	0.015	
			SA	1 NC + 1 NO	MA	S	<b>14-271.0252</b>		2	18	11	0.013
						S1	<b>14-271.022</b>		2	18	11	0.013
		M			S	<b>14-131.0252</b>		2	18	38	0.013	
					S1	<b>14-131.022</b>		2	18	38	0.013	
		2 NC + 2 NO	MA	S	<b>14-272.0252</b>		2	18	8	0.015		
			M	S	<b>14-132.0252</b>		2	18	35	0.015		
		3 NC + 3 NO	MA	S	<b>14-273.0252</b>		2	18	5	0.017		
			M	S	<b>14-133.0252</b>		2	18	32	0.017		
		4 NC + 4 NO	MA	S	<b>14-274.0252</b>		2	18	4	0.019		
			M	S	<b>14-134.0252</b>		2	18	31	0.019		

Switching system: LL = Low level switching element, SA = Snap-action switching element

Contacts: NC = Normally closed, NO = Normally open

Switching action: MA = Maintained action, M = Momentary action





Terminals: UT = Universal terminal, S = Soldering terminal, S1 = Soldering terminal (also pluggable 2.8 x 0.5 mm)

Component layout from page 36, Mounting dimensions from page 37, Technical drawing from page 38, Circuit drawing from page 48

## Illuminated mushroom-head actuator pushbutton



### Essential Accessories:

-  Front ring page 19
-  Marking plate for Mushroom-head cap page 18
-  Mushroom-head cap illuminated page 18
-  Single-LED page 24

	Front protection	Switching system	Contacts	Diode (1N 4007)	Switching action	Terminals	Ø 40 mm Typ-Nr.	Component layout	Mounting dimensions	Technical drawing	Circuit drawing		
<b>Illuminated mushroom-head actuator pushbutton</b>	IP 67	LL	1 NC	-	MA	UT	<b>14-476.036</b>	2	2	18	12	0.015	
					M	UT	<b>14-436.036</b>	2	2	18	39	0.015	
			1 NC + 1 NO	-	MA	UT	<b>14-473.036</b>	2	2	18	15	0.015	
					M	UT	<b>14-433.036</b>	2	2	18	42	0.015	
			1 NO	-	MA	UT	<b>14-475.036</b>	2	2	18	14	0.015	
					M	UT	<b>14-435.036</b>	2	2	18	41	0.015	
			2 NC	-	MA	UT	<b>14-472.036</b>	2	2	18	13	0.015	
					M	UT	<b>14-432.036</b>	2	2	18	40	0.015	
			2 NO	-	MA	UT	<b>14-471.036</b>	2	2	18	16	0.015	
					M	UT	<b>14-431.036</b>	2	2	18	43	0.015	
			SA	1 NC + 1 NO	1 D	MA	UT	<b>14-747.0292</b>	2	2	18	9	0.014
						M	UT	<b>14-743.0292</b>	2	2	18	36	0.014
		2 D			MA	UT	<b>14-748.0292</b>	2	2	18	10	0.014	
					M	UT	<b>14-744.0292</b>	2	2	18	37	0.014	
		-			MA	S	<b>14-271.0252</b>		2	18	11	0.013	
					S1	<b>14-271.022</b>		2	18	11	0.013		
		2 NC + 2 NO		1 D	MA	UT	<b>14-749.0292</b>	2	2	18	6	0.016	
					M	UT	<b>14-745.0292</b>	2	2	18	33	0.016	
				2 D	MA	UT	<b>14-750.0292</b>	2	2	18	7	0.016	
					M	UT	<b>14-746.0292</b>	2	2	18	34	0.016	
				-	MA	S	<b>14-272.0252</b>		2	18	8	0.015	
					M	S	<b>14-132.0252</b>		2	18	35	0.015	
		3 NC + 3 NO	-	MA	S	<b>14-273.0252</b>		2	18	5	0.017		
			M	S	<b>14-133.0252</b>		2	18	32	0.017			
		4 NC + 4 NO	-	MA	S	<b>14-274.0252</b>		2	18	4	0.019		
			M	S	<b>14-134.0252</b>		2	18	31	0.019			

Switching system: LL = Low level switching element, SA = Snap-action switching element

Contacts: NC = Normally closed, NO = Normally open

Diode (1N 4007): - = without, D = Diode

Switching action: MA = Maintained action, M = Momentary action

Terminals: UT = Universal terminal, S = Soldering terminal, S1 = Soldering terminal (also pluggable 2.8 x 0.5 mm)

Component layout from page 36, Mounting dimensions from page 37, Technical drawing from page 38, Circuit drawing from page 48

## Keylock switch 2 positions



	Front protection	Front ring	Switching system	Contacts	Switching action	Terminals	Key remove	Ø 29 mm Typ-Nr.	Component layout	Mounting dimensions	Technical drawing	Circuit drawing			
														Position A : Basic position Position C : Maintained action Standard lock 1001, Front : Plastic black	
<b>Keylock switch 2 positions</b> Position A : Basic position Position C : Maintained action Standard lock 1001, Front : Plastic black	IP 65	Aluminium natural	LL	1 NC + 1 NO	MA	UT	A	14-415.036K	2	5	21	54	0.030		
								C	14-418.036K	2	5	21	54	0.030	
								C + A	14-412.036K	2	5	21	54	0.030	
				2 NO	MA	UT	A	14-414.036K	2	5	21	55	0.030		
								C	14-417.036K	2	5	21	55	0.030	
								C + A	14-411.036K	2	5	21	55	0.030	
			SA	1 NC + 1 NO	MA	S	A	14-235.025K2		5	21	50	0.029		
								C	14-335.025K2		5	21	50	0.029	
								C + A	14-135.025K2		5	21	50	0.029	
							S1	A	14-235.022K		5	21	50	0.029	
									C	14-335.022K		5	21	50	0.029
									C + A	14-135.022K		5	21	50	0.029
				2 NC + 2 NO	MA	S	A	14-236.025K2		5	21	51	0.031		
								C	14-336.025K2		5	21	51	0.031	
								C + A	14-136.025K2		5	21	51	0.031	
				3 NC + 3 NO	MA	S	A	14-237.025K2		5	21	52	0.033		
								C	14-337.025K2		5	21	52	0.033	
								C + A	14-137.025K2		5	21	52	0.033	
4 NC + 4 NO	MA	S	A	14-238.025K2		5	21	53	0.035						
				C	14-338.025K2		5	21	53	0.035					
				C + A	14-138.025K2		5	21	53	0.035					
Position A : Basic position Position C : Momentary action Standard lock 1001 Front : Plastic black	IP 65	Aluminium natural	LL	1 NC + 1 NO	M	UT	A	14-438.036K	2	5	21	48	0.030		
								2 NO	M	UT	A	14-437.036K	2	5	21
			SA	1 NC + 1 NO	M	S	A	14-141.025K2		5	21	44	0.029		
								S1	A	14-141.022K		5	21	44	0.029
				2 NC + 2 NO	M	S	A	14-142.025K2		5	21	45	0.031		
				3 NC + 3 NO	M	S	A	14-143.025K2		5	21	46	0.033		
4 NC + 4 NO	M	S	A	14-144.025K2		5	21	47	0.035						

Keylock switches are supplied with 2 keys.

Other lock numbers on request

Switching system: LL = Low level switching element, SA = Snap-action switching element

Contacts: NC = Normally closed, NO = Normally open

Switching action: MA = Maintained action, M = Momentary action

Terminals: UT = Universal terminal, S = Soldering terminal, S1 = Soldering terminal (also pluggable 2.8 x 0.5 mm)

Component layout from page 36, Mounting dimensions from page 37, Technical drawing from page 38, Circuit drawing from page 48

## Selector switch 2 positions

non-illuminative



	Front protection	Front ring	Lever	Switching system	Contacts	Switching action	Terminals	Ø 29 mm Typ-Nr.	Component layout	Mounting dimensions	Technical drawing	Circuit drawing	E-1
<b>Selector switch 2 positions</b> Position A : Basic position	IP 67	Aluminium natural	Plastic black long	LL	1 NC + 1 NO	MA	UT	14-572.0360	2	5	22	29	0.025
						M	UT	14-567.0360	2	5	22	22	0.025
					2 NC	MA	UT	14-571.0360	2	5	22	28	0.025
						M	UT	14-566.0360	2	5	22	21	0.025
					2 NO	MA	UT	14-570.0360	2	5	22	30	0.025
						M	UT	14-565.0360	2	5	22	23	0.025
				SA	1 NC + 1 NO	MA	S	14-556.02502		5	22	24	0.024
						S1	14-556.0220		5	22	24	0.024	
					M	S	14-551.02502		5	22	17	0.024	
						S1	14-551.0220		5	22	17	0.024	
					2 NC + 2 NO	MA	S	14-557.02502		5	22	25	0.026
						M	S	14-552.02502		5	22	18	0.026
			3 NC + 3 NO	MA	S	14-558.02502		5	22	26	0.028		
				M	S	14-553.02502		5	22	19	0.028		
			4 NC + 4 NO	MA	S	14-559.02502		5	22	27	0.030		
				M	S	14-554.02502		5	22	20	0.030		
			Plastic black short	LL	1 NC + 1 NO	MA	UT	14-522.0360	2	5	23	29	0.025
						M	UT	14-517.0360	2	5	23	22	0.025
					2 NC	MA	UT	14-521.0360	2	5	23	28	0.025
						M	UT	14-516.0360	2	5	23	21	0.025
					2 NO	MA	UT	14-520.0360	2	5	23	30	0.025
						M	UT	14-515.0360	2	5	23	23	0.025
				SA	1 NC + 1 NO	MA	S	14-506.02502		5	23	24	0.024
						S1	14-506.0220		5	23	24	0.024	
M	S	14-501.02502				5	23	17	0.024				
	S1	14-501.0220				5	23	17	0.024				
2 NC + 2 NO	MA	S			14-507.02502		5	23	25	0.026			
	M	S			14-502.02502		5	23	18	0.026			
3 NC + 3 NO	MA	S	14-508.02502		5	23	26	0.028					
	M	S	14-503.02502		5	23	19	0.028					
4 NC + 4 NO	MA	S	14-509.02502		5	23	27	0.030					
	M	S	14-504.02502		5	23	20	0.030					

Switching system: LL = Low level switching element, SA = Snap-action switching element

Contacts: NC = Normally closed, NO = Normally open

Switching action: MA = Maintained action, M = Momentary action





Terminals: UT = Universal terminal, S = Soldering terminal, S1 = Soldering terminal (also pluggable 2.8 x 0.5 mm)

Component layout from page 36, Mounting dimensions from page 37, Technical drawing from page 38, Circuit drawing from page 48

## Indicator actuator, flush mounting



### Essential Accessories:

-  Front bezel set, flush mounting page 20
-  Lens plastic page 17
-  Marking plate for Lens plastic and metal page 18
-  Single-LED page 24

	Front protection	Terminals	Ø 35 mm Typ-Nr.	Component layout	Mounting dimensions	Technical drawing	Circuit drawing	
<b>Indicator actuator, flush mounting</b>	IP 67	S	<b>14-040.005</b>		1	24	3	0.050
		S1	<b>14-040.002</b>		1	24	3	0.050
		UT	<b>14-041.006</b>	2	1	24	2	0.050

Terminals: S = Soldering terminal, S1 = Soldering terminal (also pluggable 2.8 x 0.5 mm), UT = Universal terminal

Component layout from page 36, Mounting dimensions from page 37, Technical drawing from page 38, Circuit drawing from page 48

## Buzzer, flush mounting



	Front protection	Front cap	Terminals	Ø 35 mm Typ-Nr.	Mounting dimensions	Technical drawing	Circuit drawing	
<b>Buzzer, flush mounting</b> Operation voltage : 24 VDC	IP 40	Aluminium black	S1	<b>14-810.910</b>	1	16	1	0.016
		Aluminium natural	S1	<b>14-810.918</b>	1	16	1	0.016

Further information in the Technical Data and Typical Applications

Terminals: S1 = Soldering terminal (also pluggable 2.8 x 0.5 mm)

Mounting dimensions from page 37, Technical drawing from page 38, Circuit drawing from page 48

## Illuminated pushbutton actuator, flush mounting



### Essential Accessories:

- Front bezel set, flush mounting page 20
- Lens plastic page 17
- Marking plate for Lens plastic and metal page 18
- Single-LED page 24

	Front protection	Switching system	Contacts	Diode (1N 4007)	Switching action	Terminals	Ø 35 mm Typ-Nr.	Component layout	Mounting dimensions	Technical drawing	Circuit drawing		
<b>Illuminated pushbutton actuator, flush mounting</b>	IP 67	LL	1 NC	-	MA	UT	<b>14-476.036</b>	2	1	25	12	0.015	
					M	UT	<b>14-436.036</b>	2	1	25	39	0.015	
			1 NC + 1 NO	-	MA	UT	<b>14-473.036</b>	2	1	25	15	0.015	
					M	UT	<b>14-433.036</b>	2	1	25	42	0.015	
			1 NO	-	MA	UT	<b>14-475.036</b>	2	1	25	14	0.015	
					M	UT	<b>14-435.036</b>	2	1	25	41	0.015	
			2 NC	-	MA	UT	<b>14-472.036</b>	2	1	25	13	0.015	
					M	UT	<b>14-432.036</b>	2	1	25	40	0.015	
			2 NO	-	MA	UT	<b>14-471.036</b>	2	1	25	16	0.015	
					M	UT	<b>14-431.036</b>	2	1	25	43	0.015	
			SA	1 NC + 1 NO	1 D	MA	UT	<b>14-747.0292</b>	2	1	25	9	0.014
						M	UT	<b>14-743.0292</b>	2	1	25	36	0.014
					2 D	MA	UT	<b>14-748.0292</b>	2	1	25	10	0.014
						M	UT	<b>14-744.0292</b>	2	1	25	37	0.014
					-	MA	S	<b>14-271.0252</b>		1	25	11	0.013
							S1	<b>14-271.022</b>		1	25	11	0.013
		M				S	<b>14-131.0252</b>		1	25	38	0.013	
						S1	<b>14-131.022</b>		1	25	38	0.013	
		2 NC + 2 NO			1 D	MA	UT	<b>14-749.0292</b>	2	1	25	6	0.016
						M	UT	<b>14-745.0292</b>	2	1	25	33	0.016
			2 D	MA	UT	<b>14-750.0292</b>	2	1	25	7	0.016		
				M	UT	<b>14-746.0292</b>	2	1	25	34	0.016		
			-	MA	S	<b>14-272.0252</b>		1	25	8	0.015		
				M	S	<b>14-132.0252</b>		1	25	35	0.015		
		3 NC + 3 NO	-	MA	S	<b>14-273.0252</b>		1	25	5	0.017		
				M	S	<b>14-133.0252</b>		1	25	32	0.017		
		4 NC + 4 NO	-	MA	S	<b>14-274.0252</b>		1	25	4	0.019		
				M	S	<b>14-134.0252</b>		1	25	31	0.019		

Switching system: LL = Low level switching element, SA = Snap-action switching element

Contacts: NC = Normally closed, NO = Normally open

Diode (1N 4007): - = without, D = Diode

Switching action: MA = Maintained action, M = Momentary action

Terminals: UT = Universal terminal, S = Soldering terminal, S1 = Soldering terminal (also pluggable 2.8 x 0.5 mm)



Component layout from page 36, Mounting dimensions from page 37, Technical drawing from page 38, Circuit drawing from page 48





## Keylock switch actuator 2 positions, flush mounting

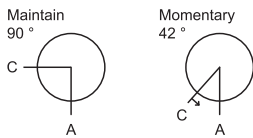

### Essential Accessories:

-  Anti-twist ring, flush mounting page 25
-  Front bezel set, flush mounting page 20



	Front protection	Switching system	Contacts	Switching action	Terminals	Key remove	Ø 35 mm Typ-Nr.	Component layout	Mounting dimensions	Technical drawing	Circuit drawing	
<b>Keylock switch actuator 2 positions, flush mounting</b> Position A : Basic position Position C : Maintained action Standard lock 1001, Front : Plastic black	IP 65	LL	1 NC + 1 NO	MA	UT	A	<b>14-415.036K</b>	2	1	26	54	0.030
						C	<b>14-418.036K</b>	2	1	26	54	0.030
						C + A	<b>14-412.036K</b>	2	1	26	54	0.030
			2 NO	MA	UT	A	<b>14-414.036K</b>	2	1	26	55	0.030
						C	<b>14-417.036K</b>	2	1	26	55	0.030
						C + A	<b>14-411.036K</b>	2	1	26	55	0.030
		SA	1 NC + 1 NO	MA	S	A	<b>14-235.025K2</b>		1	26	50	0.029
						C	<b>14-335.025K2</b>		1	26	50	0.029
						C + A	<b>14-135.025K2</b>		1	26	50	0.029
			S1			A	<b>14-235.022K</b>		1	26	50	0.029
						C	<b>14-335.022K</b>		1	26	50	0.029
						C + A	<b>14-135.022K</b>		1	26	50	0.029
			2 NC + 2 NO	MA	S	A	<b>14-236.025K2</b>		1	26	51	0.031
						C	<b>14-336.025K2</b>		1	26	51	0.031
						C + A	<b>14-136.025K2</b>		1	26	51	0.031
		3 NC + 3 NO	MA	S	A	<b>14-237.025K2</b>		1	26	52	0.033	
C	<b>14-337.025K2</b>					1	26	52	0.033			
C + A	<b>14-137.025K2</b>					1	26	52	0.033			
4 NC + 4 NO	MA	S	A	<b>14-238.025K2</b>		1	26	53	0.035			
			C	<b>14-338.025K2</b>		1	26	53	0.035			
			C + A	<b>14-138.025K2</b>		1	26	53	0.035			
Position A : Basic position Position C : Momentary action Standard lock 1001 Front : Plastic black	IP 65	LL	1 NC + 1 NO	M	UT	A	<b>14-438.036K</b>	2	1	26	48	0.030
			2 NO	M	UT	A	<b>14-437.036K</b>	2	1	26	49	0.030
		SA	1 NC + 1 NO	M	S	A	<b>14-141.025K2</b>		1	26	44	0.029
						S1	A	<b>14-141.022K</b>		1	26	44
			2 NC + 2 NO	M	S	A	<b>14-142.025K2</b>		1	26	45	0.031
		3 NC + 3 NO	M	S	A	<b>14-143.025K2</b>		1	26	46	0.033	
		4 NC + 4 NO	M	S	A	<b>14-144.025K2</b>		1	26	47	0.035	

Keylock switches are supplied with 2 keys.

Other lock numbers on request

Switching system: LL = Low level switching element, SA = Snap-action switching element

Contacts: NC = Normally closed, NO = Normally open

Switching action: MA = Maintained action, M = Momentary action

Terminals: UT = Universal terminal, S = Soldering terminal, S1 = Soldering terminal (also pluggable 2.8 x 0.5 mm)

Component layout from page 36, Mounting dimensions from page 37, Technical drawing from page 38, Circuit drawing from page 48

## Selector switch actuator 2 positions, flush mounting



### Essential Accessories:

- Anti-twist ring, flush mounting page 25
- Front bezel set, flush mounting page 20

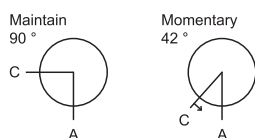

	Front protection	Lever	Switching system	Contacts	Switching action	Terminals	Ø 35 mm Typ-Nr.	Component layout	Mounting dimensions	Technical drawing	Circuit drawing	
<b>Selector switch actuator 2 positions, flush mounting</b> Position A : Basic position	IP 67	Plastic black short	LL	1 NC + 1 NO	MA	UT	<b>14-522.0360</b>	2	1	27	29	0.025
					M	UT	<b>14-517.0360</b>	2	1	27	22	0.025
				2 NC	MA	UT	<b>14-521.0360</b>	2	1	27	28	0.025
					M	UT	<b>14-516.0360</b>	2	1	27	21	0.025
				2 NO	MA	UT	<b>14-520.0360</b>	2	1	27	30	0.025
					M	UT	<b>14-515.0360</b>	2	1	27	23	0.025
			SA	1 NC + 1 NO	MA	S	<b>14-506.02502</b>		1	27	24	0.024
					S1	<b>14-506.0220</b>		1	27	24	0.024	
					M	S	<b>14-501.02502</b>		1	27	17	0.024
					S1	<b>14-501.0220</b>		1	27	17	0.024	
				2 NC + 2 NO	MA	S	<b>14-507.02502</b>		1	27	25	0.026
					M	S	<b>14-502.02502</b>		1	27	18	0.026
				3 NC + 3 NO	MA	S	<b>14-508.02502</b>		1	27	26	0.028
					M	S	<b>14-503.02502</b>		1	27	19	0.028
4 NC + 4 NO	MA	S	<b>14-509.02502</b>		1	27	27	0.030				
	M	S	<b>14-504.02502</b>		1	27	20	0.030				

Switching system: LL = Low level switching element, SA = Snap-action switching element

Contacts: NC = Normally closed, NO = Normally open

Switching action: MA = Maintained action, M = Momentary action

Terminals: UT = Universal terminal, S = Soldering terminal, S1 = Soldering terminal (also pluggable 2.8 x 0.5 mm)

Component layout from page 36, Mounting dimensions from page 37, Technical drawing from page 38, Circuit drawing from page 48

## Front

### Lens plastic

To obtain IP 67 use Marking plate Typ-Nr. 704.609.X

	Lens	Ø 29 mm Typ-Nr.	
<b>Lens plastic</b>	black opaque flush	<b>704.602.0</b>	0.001
	blue transparent flush	<b>704.602.6</b>	0.001
	colourless transparent flush	<b>704.602.7</b>	0.001
	green transparent flush	<b>704.602.5</b>	0.001
	red transparent flush	<b>704.602.2</b>	0.001
	yellow transparent flush	<b>704.602.4</b>	0.001



### Lens raised, plastic

To obtain IP 67 use Marking plate Typ-Nr. 704.610.X

	Lens	Ø 29 mm Typ-Nr.	
<b>Lens raised, plastic</b>	colourless transparent flush	<b>704.611.7</b>	0.002
	green transparent flush	<b>704.611.5</b>	0.002
	red transparent flush	<b>704.611.2</b>	0.002
	yellow transparent flush	<b>704.611.4</b>	0.002



### Lens metal with spot

To obtain IP 67 use Marking plate Typ-Nr. 704.609.X

	Lens	Ø 29 mm Typ-Nr.	
<b>Lens metal with spot</b>	Aluminium black flush	<b>704.601.01</b>	0.001
	Aluminium blue flush	<b>704.601.61</b>	0.001
	Aluminium gold flush	<b>704.601.41</b>	0.001
	Aluminium natural flush	<b>704.601.81</b>	0.001
	Aluminium olive-green flush	<b>704.601.51</b>	0.001
	Aluminium red flush	<b>704.601.21</b>	0.001
	Stainless steel natural flush	<b>704.601.91</b>	0.001



### Lens metal

To obtain IP 67 use Marking plate Typ-Nr. 704.609.9

	Lens	Ø 29 mm Typ-Nr.	
<b>Lens metal</b>	Aluminium black flush	<b>704.601.0</b>	0.001
	Aluminium blue flush	<b>704.601.6</b>	0.001
	Aluminium gold flush	<b>704.601.4</b>	0.001
	Aluminium natural flush	<b>704.601.8</b>	0.001
	Aluminium olive-green flush	<b>704.601.5</b>	0.001
	Aluminium red flush	<b>704.601.2</b>	0.001
	Stainless steel natural flush	<b>704.601.9</b>	0.001



## Lens cap

To obtain IP 67 use Marking plate Typ-Nr. 704.608.X

	Lens	Ø 29 mm Typ-Nr.	
<b>Lens cap</b>	Plastic blue transparent	<b>704.603.6</b>	0.003
	Plastic colourless transparent	<b>704.603.7</b>	0.003
	Plastic green transparent	<b>704.603.5</b>	0.003
	Plastic red transparent	<b>704.603.2</b>	0.003
	Plastic yellow transparent	<b>704.603.4</b>	0.003



## Mushroom-head cap

To obtain IP 67 use Marking plate Typ-Nr. 704.609.9

	Mushroom had cap	Ø 40 mm Typ-Nr.	
<b>Mushroom-head cap</b>	Plastic black opaque	<b>704.604.0</b>	0.001
	Plastic green opaque	<b>704.604.5</b>	0.001
	Plastic red opaque	<b>704.604.2</b>	0.001
	Plastic yellow opaque	<b>704.604.4</b>	0.001



## Mushroom-head cap illuminated

To obtain IP 67 use Marking plate Typ-Nr. 704.609.9

	Mushroom had cap	Ø 40 mm Typ-Nr.	
<b>Mushroom-head cap illuminated</b>	Plastic blue transparent	<b>704.614.6</b>	0.007
	Plastic colourless transparent	<b>704.614.7</b>	0.007
	Plastic green transparent	<b>704.614.5</b>	0.007
	Plastic red transparent	<b>704.614.2</b>	0.007
	Plastic yellow transparent	<b>704.614.4</b>	0.007



## Marking plate for Lens plastic and metal

	Marking plate	Typ-Nr.	
<b>Marking plate for Lens plastic and metal LED</b>	Plastic colourless transparent ribbed	<b>704.609.7</b>	0.001
	LED and Filament lamp non-illuminative	<b>704.609.9</b>	0.001
	Plastic black opaque	<b>704.609.0</b>	0.001



## Marking plate for Mushroom-head cap

	Marking plate	Typ-Nr.	
<b>Marking plate for Mushroom-head cap</b>	Plastic white translucent	<b>704.609.9</b>	0.001



## Marking cap for Lens raised, plastic

	Marking cap	Typ-Nr.	
<b>Marking cap for Lens raised, plastic</b> LED	Plastic colourless transparent ribbed	<b>704.610.7</b>	0.001
LED and Filament lamp	Plastic white translucent	<b>704.610.9</b>	0.001



## Marking cap for Lens cap

	Marking cap	Typ-Nr.	
<b>Marking cap for Lens cap</b> LED	Plastic colourless transparent ribbed	<b>704.608.7</b>	0.002
LED and Filament lamp	Plastic white translucent	<b>704.608.9</b>	0.002



## Front ring

	Ø 29 mm Typ-Nr.	
<b>Front ring</b>	<b>704.600.0</b>	0.003
	<b>704.600.6</b>	0.003
	<b>704.600.1</b>	0.005
	<b>704.600.1A</b>	0.005
	<b>704.600.9</b>	0.006



## Front bezel set for Mushroom-head pushbutton

	Front Bezel	Ø 50 mm Typ-Nr.	Mounting dimensions	Technical drawing	
<b>Front bezel set for Mushroom-head pushbutton</b>	Aluminium black	<b>14-958.0</b>	4	28	0.042
	Aluminium natural	<b>14-958.8</b>	4	28	0.042



Mounting dimensions from page 37, Technical drawing from page 38

## Front bezel set, flush mounting

	Front bezel	Ø 35 mm Typ-Nr.	Mounting dimensions	
<b>Front bezel set, flush mounting</b>	Aluminium black	<b>704.955.0</b>	1	0.015
	Aluminium natural	<b>704.955.1</b>	1	0.015
	Stainless steel natural	<b>704.955.9</b>	1	0.033



Mounting dimensions from page 37

## Legend frame

adhesive, Aluminium black

	Legend frame	Typ-Nr.	Technical drawing	
<b>Legend frame</b>	30 x 50 mm for raised mounting	<b>704.968.2</b>	9	0.001
	35 x 57.5 mm for flush mounting	<b>704.968.3</b>	10	0.001



Technical drawing from page 38

## Legend plate insert

for Legend frame 704.968.2 and 704.968.3

	Legend plate insert	Typ-Nr.	kg	
<b>Legend plate insert</b>	14.5 x 23.5 mm, adhesive, Aluminium black	<b>704.968.1</b>	0.001	
	14.5 x 23.5 mm, adhesive, Aluminium natural	<b>704.968.0</b>	0.001	



## Protective cover, raised mounting

Mounting hole size 22.5 mm dia.

	Protective cover, raised mounting	Typ-Nr.	Technical drawing	
<b>Protective cover, raised mounting</b>	hinged, transparent, with means for sealing, for Pushbutton	<b>704.925.0</b>	4	0.007
	hinged, transparent, with means for sealing, for Selector switch	<b>704.925.2</b>	6	0.007
	hinged, transparent, with means for sealing, with spring fitted, for Pushbutton	<b>704.925.3</b>	4	0.007



Protection cover 704.925.2 only for selector switches in basic position A applicable.

Technical drawing from page 38

## Protective cover, flush mounting

Mounting hole size 30.5 mm dia.

	Typ-Nr.	Technical drawing	
<b>Protective cover, flush mounting</b> hinged, Aluminium natural, with means for sealing, for Pushbutton and Selector switch short lever	<b>704.928.38</b>	8	0.019
hinged, Aluminium natural, with means for sealing, spring fitted, for Pushbutton and Selector switch short lever	<b>704.928.28</b>	5	0.019
hinged, Aluminium natural, with window, spring fitted, for Pushbutton	<b>704.928.18</b>	7	0.019



Technical drawing from page 38

## Front protective cap

for Indicator and Illuminated pushbutton for protection IP 68

	Front protective cap	Typ-Nr.	
<b>Front protective cap</b> only together with Lenses 704.602.X, 704.601.X and Front rings 704.600.X	Silicone colourless transparent	<b>704.953.0</b>	0.002



## Front protective ring

for Illuminated pushbutton with front illumination (IP 67)

	Front protective ring	Ø 29 mm Typ-Nr.	
<b>Front protective ring</b> with transparent Pebax membrane, temperature resistance -40 °C ... +85 °C	Aluminium natural	<b>704.600.5/A</b>	0.005
with transparent silicone membrane (extent resistant to sea water), temperature resistance -40 °C ... +85 °C	Aluminium natural	<b>704.600.3</b>	0.005
	Chromed brass	<b>704.600.2</b>	0.005



Front protective ring to be mounted with a torque of 40 Ncm onto actuator.

## Front bezel with protective membrane, flush mounting

for Illuminated pushbutton (IP 67)

	Front bezel	Ø 35 mm Typ-Nr.	
<b>Front bezel with protective membrane, flush mounting</b> with transparent silicone membrane	Aluminium black	<b>704.955.4</b>	0.015
	Aluminium natural	<b>704.955.3</b>	0.015
with transparent silicone membrane, resistant to sea water	Stainless steel natural	<b>704.955.9E</b>	0.033



Front bezel to be mounted with a torque of 40 Ncm onto actuator.

## Blind plug

	Blind plug	Front protection	Typ-Nr.	Technical drawing	
<b>Blind plug</b> Size 28 mm dia., for mounting hole 22.5 mm dia.	Plastic black	IP 65	<b>704.960.4</b>	3	0.004
Size 36 mm dia., for mounting hole 30.5 mm dia.	Plastic black	IP 65	<b>704.964.8</b>	2	0.007



Technical drawing from page 38

## Spare key

	Typ-Nr.	
<b>Spare key</b> Standard lock 1001 (KABA)	<b>14-987.1001</b>	0.006



Other lock numbers on request

## Backside

### PCB plug-in base

	Typ-Nr.	Component layout	
<b>PCB plug-in base</b> 16.4 mm dia. x 9.8 mm for Low level switching element, Pins axial	<b>31-940</b>	3	0.002
17.8 x 12.9 mm x 9.8 mm for Snap-action switching element 2.8 mm, Pins axial	<b>31-942</b>	4	0.002
17.9 x 17.9 x 8.4 mm for Low level switching element, Pins bent at right-angle	<b>31-941</b>	1	0.004



PCB plug-in base Pins right-angle : With the extendable mounting the distance between plug-in base and PCB can be varied up to 3 mm.

Component layout from page 36

## Flat receptacle

	Typ-Nr.	
<b>Flat receptacle</b> 2.0 x 0.5 mm for Universal terminal	<b>31-945</b>	0.001
2.8 x 0.5 mm for Plug-in terminal	<b>31-946</b>	0.001





## Insulation sleeve

	Typ-Nr.	
<b>Insulation sleeve</b> Cover Plug-in terminals for snap-action switching element 2.8 mm	<b>01-928</b>	0.001
for Flat receptacle 31-945	<b>31-928</b>	0.001
for Flat receptacle 31-946	<b>31-929</b>	0.001



## Terminal cover

	Typ-Nr.	
<b>Terminal cover</b>	<b>01-929</b>	0.010



## Illumination

### Filament lamp

	Socket	Operating voltage/-current	Typ-Nr.	
<b>Filament lamp</b>	T5.5	12 VAC/DC, 100 mA	<b>10-1109.1329</b>	0.001
		12 VAC/DC, 50 mA	<b>10-1109.1279</b>	0.001
		24 VAC/DC, 25 mA	<b>10-1112.1199</b>	0.001
		24 VAC/DC, 50 mA	<b>10-1112.1279</b>	0.001
		28 VAC/DC, 40 mA	<b>10-1113.1249</b>	0.001
		30 VAC/DC, 40 mA	<b>10-1114.1249</b>	0.001
		36 VAC/DC, 35 mA	<b>10-1116.1229</b>	0.001
		48 VAC/DC, 25 mA	<b>10-1119.1199</b>	0.001
		6 VAC/DC, 200 mA	<b>10-1106.1369</b>	0.001



## Single-LED

Single-LED	Socket	Light colour	Operating voltage/-current	Typ-Nr.	
Single-LED	T5.5	blue	12 VAC/DC, 7/14 mA	<b>10-2109.1066</b>	0.001
			24 VAC/DC, 7/14 mA	<b>10-2112.1066</b>	0.001
			28 VAC/DC, 7/14 mA	<b>10-2113.1066</b>	0.001
			48 VAC/DC, 4/8 mA	<b>10-2119.1046</b>	0.001
			6 VDC, 15 mA	<b>10-2106.3146</b>	0.001
		green	12 VAC/DC, 7/14 mA	<b>10-2109.1065</b>	0.001
			24 VAC/DC, 7/14 mA	<b>10-2112.1065</b>	0.001
			28 VAC/DC, 7/14 mA	<b>10-2113.1065</b>	0.001
			48 VAC/DC, 4/8 mA	<b>10-2119.1045</b>	0.001
			6 VDC, 15 mA	<b>10-2106.3145</b>	0.001
		red	12 VAC/DC, 7/14 mA	<b>10-2109.1062</b>	0.001
			24 VAC/DC, 7/14 mA	<b>10-2112.1062</b>	0.001
			28 VAC/DC, 7/14 mA	<b>10-2113.1062</b>	0.001
			48 VAC/DC, 4/8 mA	<b>10-2119.1042</b>	0.001
			6 VDC, 15 mA	<b>10-2106.3142</b>	0.001
		white diffuse	12 VAC/DC, 7/14 mA	<b>10-2109.1069</b>	0.001
			24 VAC/DC, 7/14 mA	<b>10-2112.1069</b>	0.001
			28 VAC/DC, 7/14 mA	<b>10-2113.1069</b>	0.001
			48 VAC/DC, 4/8 mA	<b>10-2119.1049</b>	0.001
			6 VDC, 15 mA	<b>10-2106.3149</b>	0.001
		yellow	12 VAC/DC, 7/14 mA	<b>10-2109.1064</b>	0.001
			24 VAC/DC, 7/14 mA	<b>10-2112.1064</b>	0.001
			28 VAC/DC, 7/14 mA	<b>10-2113.1064</b>	0.001
			48 VAC/DC, 4/8 mA	<b>10-2119.1044</b>	0.001
6 VDC, 15 mA	<b>10-2106.3144</b>		0.001		



Note:  
AC operation through halve-wave rectifier possible, slight flickering can occur.

## Terminal plate empty

for fitting with series resistors

	Typ-Nr.	
<b>Terminal plate empty</b> 10 spaces 125 x 60 x 15 mm	<b>02-912.2</b>	0.045
15 spaces 187.5 x 60 x 15 mm	<b>02-912.3</b>	0.090
20 spaces 250 x 60 x 15 mm	<b>02-912.4</b>	0.095
5 spaces 62.5 x 60 x 15 mm	<b>02-912.1</b>	0.025



## Assembling

### Positioning insert

	Typ-Nr.	Mounting dimensions	
<b>Positioning insert</b>	<b>14-910</b>	3	0.001



Mounting dimensions from page 37

### Anti-twist ring, flush mounting

	Typ-Nr.	
<b>Anti-twist ring, flush mounting</b>	<b>704.954.0</b>	0.002



### Reducing ring

Devices 22.5 mm dia. in mounting hole size 30.5 mm dia.

	Typ-Nr.	
<b>Reducing ring</b> Aluminium black	<b>704.960.0</b>	0.004
Aluminium natural	<b>704.960.8</b>	0.004



You need to install two reduction rings.

### Lens plug for round lens, flush mounting

	Typ-Nr.	
<b>Lens plug for round lens, flush mounting</b> for mounting and dismantling of Lens round, flush mounting	<b>700.006.0</b>	0.003



### Lamp remover

	Typ-Nr.	
<b>Lamp remover</b>	<b>02-906</b>	0.002



#### CAUTION

A switching process might be released when replacing the Lamp/LED !

## Enclosure

Grey similar RAL 7035; cover lead-sealable

	Dimension	Typ-Nr.	Technical drawing	
<b>Enclosure</b> with mounting hole 1 x 22.5 mm dia., with anti-twist device	L 94 mm, W 94 mm, H 81 mm	<b>704.945.1</b>	11	0.211
with mounting hole 2 x 22.5 mm dia., with anti-twist device	L 130 mm, W 94 mm, H 81 mm	<b>704.945.2</b>	12	0.251
with mounting hole 3 x 22.5 mm dia., with anti-twist device	L 180 mm, W 94 mm, H 81 mm	<b>704.945.3</b>	13	0.313
with mounting hole 4 x 22.5 mm dia., with anti-twist device	L 180 mm, W 182 mm, H 110 mm	<b>704.945.4</b>	14	0.572
with mounting hole 6 x 22.5 mm dia., with anti-twist device	L 180 mm, W 182 mm, H 110 mm	<b>704.945.5</b>	15	0.568



Openings for cable gland M16 or M20.

Protection class IP 66.

Technical drawing from page 38

## Cable gland

	Typ-Nr.	kg
<b>Cable gland</b> M16, Plastic grey	<b>61-9481.6</b>	0.007
M20, Plastic grey	<b>704.945.6</b>	0.011



with traction relief; protection degree IP 68.

## Actuator with snap-action switching element

### Switching system

Self-cleaning, double-break, snap action switching system (with contact gap 2 x 0.5 mm).  
 1 normally closed or 1 normally open contact per element.  
 Snap-action switching elements with soldering terminals at the sides: up to 4 switching element can be on a pushbutton (max. 4 normally closed and 4 normally open contacts).  
 Snap-action switching element with axial plug-in terminals 2.8 mm stackable, only 1 switching element can be on a pushbutton.

### Material

**Material of contact**  
 Gold plated silver

**Switch housing**  
 Plug-in-/soldering terminal  
 Diallylphthalate DAP, Polyamide 66, Polysulfone, heat-resistant and self-extinguishing  
 Soldering terminal: PA 6.6 Ultramide

**Actuator housing**  
 Polyamide

### Mechanical characteristics

#### Terminals

Snap-action switching element with tinned soldering terminals at the sides:  
 Max. wire diameter 2 wires à 1.2 mm  
 max. wire cross-section of stranded cable 1 x 1 mm<sup>2</sup>

Snap-action switching element with axial plug-in terminals, which can also be used as soldering terminals: Plug-in terminal 2.8 x 0.5 mm

Soldering terminal:  
 Max. wire diameter 2 wires of 1 mm  
 Max. wire cross-section of stranded cable 2 x 0.75 mm<sup>2</sup> or 1 x 1.0 mm<sup>2</sup>

#### Actuating torque

Measured at the key or lever of the keylock- or selector switch  
 2.5 Ncm ... 5.5 Ncm, depending on the number of switching elements

#### Actuating force

Maintain 5 N ... 7.8 N  
 Momentary 3.2 N ... 6 N  
 depending on the number of switching elements

#### Actuating travel

Illuminated pushbutton: 3 mm  
 Switch actuator 2 positions:  
 Momentary action 1 x ca. 42° deflection momentary action  
 Maintained action 1 x ca. 90° deflection maintained action

#### Rebound time

≤5ms

#### Mechanical lifetime

Momentary action	2 million	Cycles of operation
Maintained action	1 million	Cycles of operation

### Electrical characteristics

#### Standards

The devices comply with : EN IEC 61058-1

#### Rated voltage

250 VAC/DC as per EN IEC 61058-1-15

#### Contact resistance

New state ≤50 mΩ as per DIN IEC 60512-2-4

#### Electrostatic discharge (ESD)

Keylock switch 15 kV

#### Rated current

5 A

#### Conventional free air thermal current I<sub>th</sub>

5 A

The maximum current in continuous operation and at ambient temperature not exceeding the quoted maximum values.

#### Switch rating

250 VAC, 5 A (cosφ 1)  
 250 VAC, 3 A (cosφ 0,3)

Switch rating AC (cosφ 0,7)

Voltage	125 VAC	250 VAC
Current	3 A	2 A

Switch rating DC (inductive) L:R = 30 ms

Voltage	24 VDC	60 VDC	110 VDC	220 VDC
Current	2 A	0.7 A	0.2 A	0.1 A

#### Electric strength

3000 VAC, 50 Hz, 1 min. between all terminals and earth, as per EN IEC 61058-1-15

#### Isolation resistance

>7 MΩ between the open contacts at 500 VDC, as per EN IEC 61058-1-15 (reinforced insulation)

#### Protection class

II

### Environmental conditions

#### Storage temperature

-40 °C ... +85 °C

#### Service temperature

-25 °C ... +55 °C

For indicators and illuminated pushbuttons mounted as a block, make sure the heat can escape freely.

#### Protection degree

as per EN IEC 60529  
 front side IP 67

#### Shock resistance

(semi-sinusoidal)  
 max. 150 m/s<sup>2</sup>, pulse width 11 ms, 3-axis, as per EN IEC 60068-2-27

#### Vibration resistance

(sinusoidal)  
 max. 100 m/s<sup>2</sup> at 10 Hz ... 500 Hz, as per EN IEC 60068-2-6

## Climate resistance

Damp heat state as per EN IEC 60068-2-30  
Damp heat cyclic as per EN IEC 60068-2-78

## Approvals

### Approbations

CB (IEC 61058)  
CSA  
ENEC (EN 61058)  
Germanischer Lloyd  
UL

### Declaration of conformity

CE

## Rebound time

typical <100  $\mu$ s

## Mechanical lifetime

Momentary action 5 million cycles of operation  
Maintained action 1 million cycles of operation

## Electrical characteristics

### Contact resistance

New state  $\leq 50$  m $\Omega$  as per DIN IEC 60512-2-4

### Electrostatic discharge (ESD)

Keylock switch 15 kV

### Switch rating

10  $\mu$ A, 100  $\mu$ V to 100 mA at 42 VAC/VDC

### Electric strength

3000 VAC, 50 Hz, 1 min. between all terminals and earth, as per EN IEC 61058-1-15

### Protection class

II

## Environmental conditions

### Storage temperature

-40  $^{\circ}$ C ... +85  $^{\circ}$ C

### Service temperature

-25  $^{\circ}$ C ... +55  $^{\circ}$ C

For indicators and illuminated pushbuttons mounted as a block, make sure the heat can escape freely.

### Protection degree

as per EN IEC 60529  
front side IP 67

### Shock resistance

(semi-sinusoidal)  
max. 150 m/s<sup>2</sup>, pulse width 11 ms, 3-axis, as per EN IEC 60068-2-27

## Actuator with low level switching element

## Switching system

This low level switching element was designed for switching low powers in electronic circuits. The mechanism assures reliable switching of loads ranging from a few  $\mu$ A/ $\mu$ V up to 100 mA/42 VAC/DC.

Single-break momentary contact, as normally open or normally closed with 4 independent points of contact. 2 momentary contacts per switching element; combination of normally open and normally closed is possible.

Special features are the long life, extremely short rebound time and stable contact resistance.

## Material

### Material of contact

Gold plated

### Switch housing

Polysulfone, heat-resistant and self-extinguishing

### Actuator housing

Polyamide

## Mechanical characteristics

### Terminals

The universal terminals permit these units to be mounted on printed circuit boards (PCB). These terminals can also be used as soldering or plug-in terminals.

For these terminals we can also supply a plug-in base which, when soldered on to the board, enables the switch to be plugged in.

Soldering terminal:

Max. wire diameter 2 wires of 1 mm

Max. wire cross-section of stranded cable 2 x 0.75 mm<sup>2</sup>

Plug-in terminal: 2.0 x 0.5 mm.

### Actuating torque

Measured at the key or lever of the keylock- or selector switch  
2.5 Ncm ... 5.5 Ncm, depending on the number of switching elements

### Actuating force

3 ... 4 N, depending on the number of switching elements

### Actuating travel

Illuminated pushbutton : 3 mm

Switch actuator 2 positions:

Momentary action 1 x ca. 42 $^{\circ}$  deflection momentary action

Maintained action 1 x ca. 90 $^{\circ}$  deflection maintained action

## Buzzer

## Buzzer system

### System

Piezo disc

## Material

### Alarm buzzer case

Polyamide

### Front cap

Plastic Polyamide

Metal Nickel-plated brass (sea-water proof)

## Mechanical characteristics

### Terminals

Plug-in terminal 2.8 x 0.5 mm

## Electrical characteristics

### Frequency (tone)

approx. 2.8 kHz continuous tone only

**Sound pressure**

95 db (A)  $\pm 8$  dB at a distance of 0.1 m

**Operation Voltage/Current**

Operation Voltage 24 VDC  $\pm 10$  %

Operation Current  $\leq 25$  mA

**Environmental conditions****Storage temperature**

-40 °C ... +85 °C

**Operating temperature**

-25 °C ... +55 °C

**Protection degree**

as per EN IEC 60529, frontside

IP 40, devices flush mounting

IP 65, devices raised mounting

**Approvals****Declaration of conformity**

CE

## Diode element

When indicators and illuminated pushbuttons equipped with diodes, the user is able to perform a lamp check or wire an alarm circuit simply with a considerable saving of space.

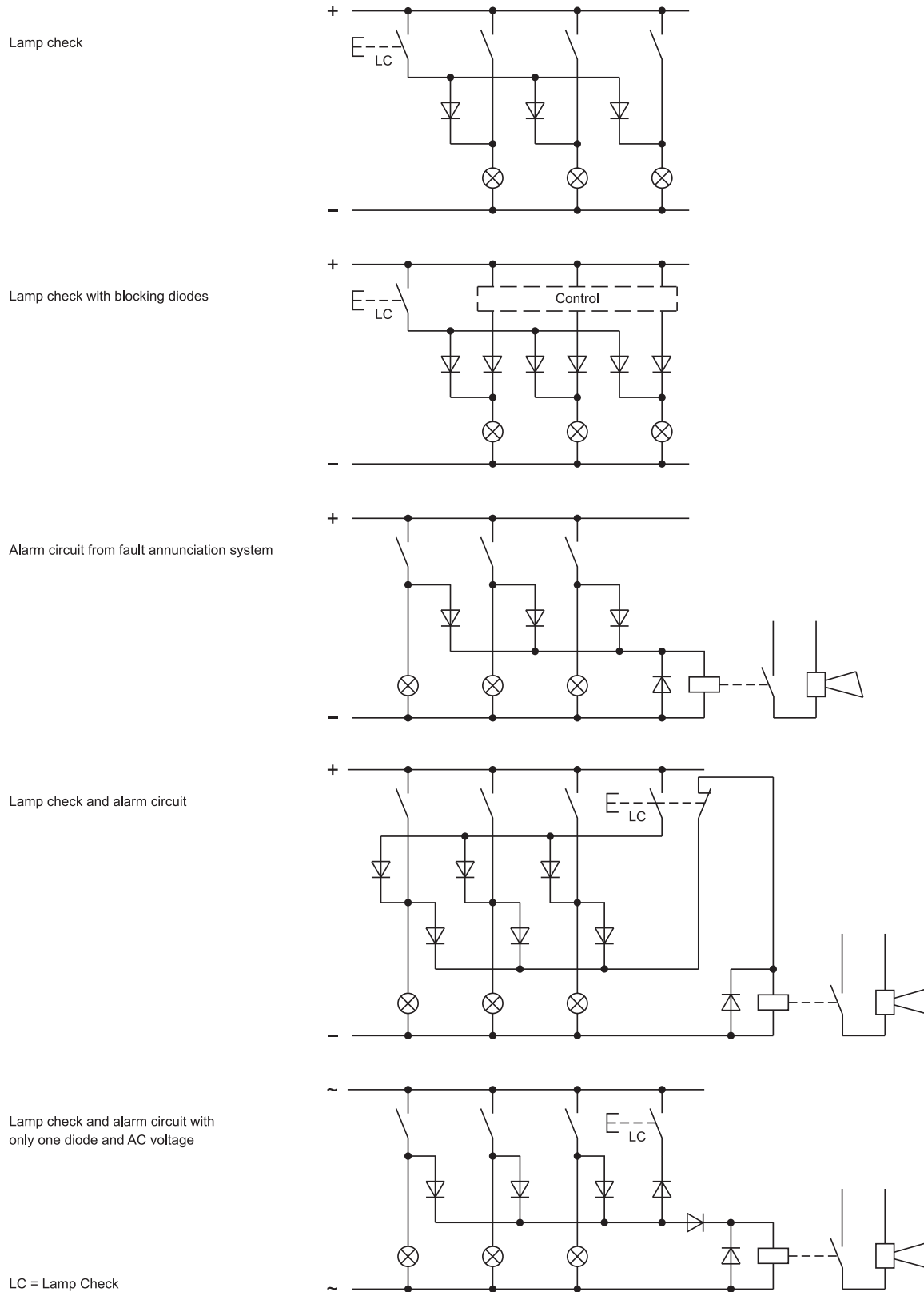



## Suppressor circuits

When switching inductive loads such as relays, DC motors, and DC solenoids, it is always important to absorb surges (e.g. with a diode) to protect the contacts. When these inductive loads are switched off, a counter emf can severely damage switch contacts and greatly shorten lifetime.

Fig. 1 shows an inductive load with a free-wheeling diode connected in parallel. This free-wheeling diode provides a path for the inductor current to flow when the current is interrupted by the switch. Without this free-wheeling diode, the voltage across the coil will be limited only by dielectric breakdown voltages of the circuit or parasitic elements of the coil. This voltage can be kilovolts in amplitude even when nominal circuit voltages are low (e.g. 12 VDC) see Fig. 2.

The free-wheeling diode should be chosen so that the reverse breakdown voltage is greater than the voltage driving the inductive load. The DC blocking voltage (VR) of the free-wheeling diode can be found in the datasheet of a diode. The forward current should be equal or greater than the maximum current flowing through the load.

**To get an efficient protection, the free-wheeling diode must be connected as close as possible to the inductive load!**

Switching with inductive load  
Fig. 1

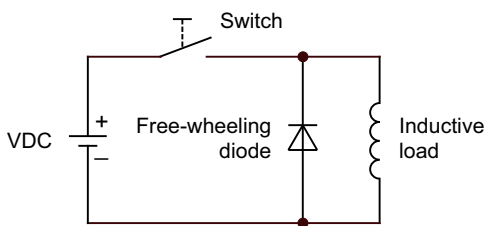

Counter emf  
over load without free-wheeling diode  
Fig. 2

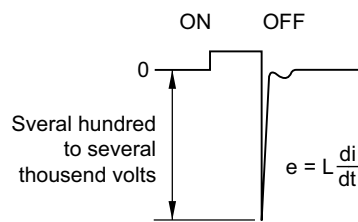

## General notes

### 1. Engraving

In addition to the most commonly used world languages, in DIN 1451-3 close spacing, other typefaces are available as Scandinavian, Slavic, Greek, Russian and Polish.

The lenses are filled with black or white colour. Standard height of letters is 3 mm. If the height is not specified, we will supply 3 mm engraved letters.

### 2. Hot stamping

Standard legends and ISO symbols are hot stamped. For larger series it is worth considering markings by means of hot stamping. We will be pleased to advise you.

## Engraving marking cap for Indicator round, full face illumination

All dimensions in mm

Height of letters	Number of lines	Number of (target value) letters per line			Line spacing
		b1	b2	b3	
3	3	11	10	9	4.6
4	2	8	7	-	6.6
8	1	4	-	-	-

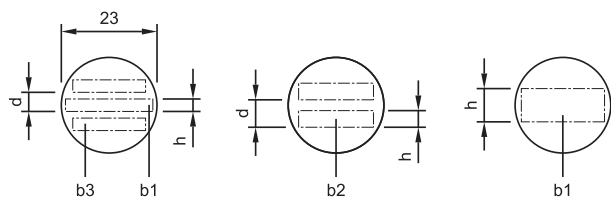

The gap between 2 words results in each case a letter less.

## Engraving marking cap for Indicator and illuminated Pushbutton round, front illumination

All dimensions in mm

Height of letters	Number of lines	Number of (target value) letters per line			Line spacing
		b1	b2	b3	
3	3	9	9	7	4.6
4	2	7	6	-	6.6
8	1	3	-	-	-

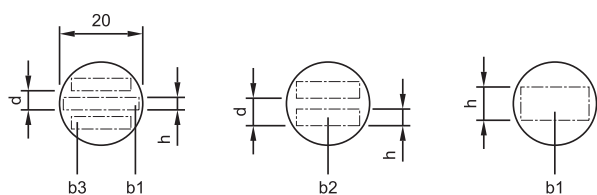

The gap between 2 words results in each case a letter less.

## Engraving legend plates

All dimensions in mm

Dimension	Devices mounting style	Height of letters h	Number of lines	Number of (target value) letters per line	Image
30 x 50	round, raised	3	2	12	B1
		4	1	7	B1
		8	1	4	B1
35 x 57.5	round, flush	3	2	12	B2
		4	1	7	B2
		8	1	4	B2

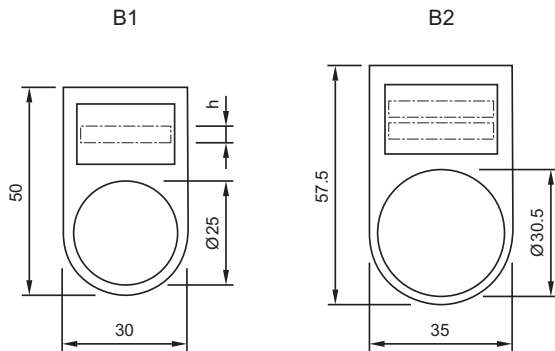







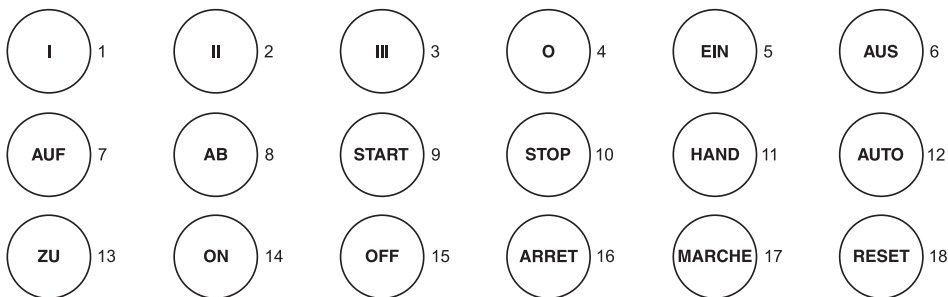





















































The gap between 2 words results in each case a letter less.

## Standard texts for marking plates and marking caps for Indicator and Illuminated Pushbutton

Height of letters 6 mm



## Symbols for marking plates and marking caps for Indicator and Illuminated Pushbutton

	1 Direction of linear rectilinear motion (also for $\rightarrow \updownarrow$ )		13 Direction of spindle rotation		29 Decrease of value (speed, for instance)		49 Cooling pump
	2 Linear motion in in 2 directions (also for $\updownarrow$ )		14 One revolution		30 Speed of planing cut		50 Lubricant pump
	3 Interrupted linear motion (also for $\leftarrow \updownarrow \rightarrow$ )		15 Number of revolutions per minute (spindle speed)		31 Speed of turning cut		51 Hydraulic system pump
	4 Limited linear motion (also for $\leftarrow \updownarrow$ )		16 Feed		32 Speed of drilling cut		52 Hydraulic motor
	5 Limited linear motion and return		17 Feed per revolution		33 Speed of milling cut (similar symbol for speed of grinding)		53 Tracer
	6 Oscillating linear motion (continuous)		18 Feed per minute		34 Conventional milling		61 Stepless regulation
	7 Direction of continuous rotation (right)		19 Reduced feed		35 Climb milling (down milling)		62 Adjustable
	7a Direction of continuous rotation (left)		20 Rapid feed		41 Electric motor		63.1 Lock or tighten
	8 Rotation in 2 directions		21 Normal feed		42 Rectangular work table or slide element		63.2 Lock or tighten
	9 Direction of interrupted rotation (right)		22 Direction of feed (orientation not specified)		43 Round work table or rotating element		64.1 Unlock, unclamp
	9a Direction of interrupted rotation (left)		24 Transverse feed		44 Turning spindle		64.2 Chuck open
	10 Limited rotation (right)		25 Vertical feed		45 Drilling spindle		65 Brake on
	10a Limited rotation (left)		26 Rapid traverse		46 Milling spindle		66 Brake off
	11 Limited rotation and return		27 Threading		47 Grinding spindle		67 Automatic (or semi-automatic) cycle
	12 Oscillating rotary movement (continuous)		28 Increase of value (speed, for instance)		48 Pump (general symbol)		68 Hand control

Continuation see next page

Continued from previous page



69 Start, on



77 Open lock-nut



93 Caution!



106 Drain



70 Stop, off



78 Engage sensor



94 Main switch



107 Oil, lubricant



71 Start and stop with same button



79 Disengage sensor



101 Coolant fluid



108 Blast



72 In action as long as button is operated



80 Change speed only in stopped position



102 Machine lighting



109 Suction



74 Engaging (mechanical start)



81 Change speed only in motion



103 Weight



75 Disengaging (mechanical stop)



91 Shear pin construction



104 Filter opening



76 Close lock-nut



92 Danger (high voltage)



105 Overflow

## Component layout

### 1 PCB plug-in base page 22

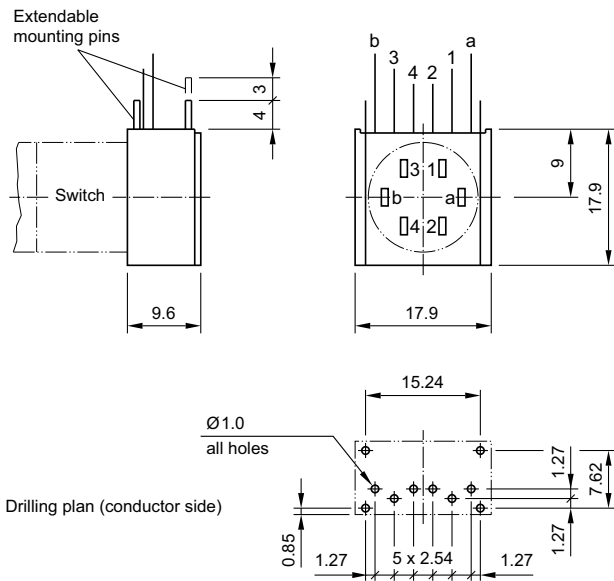

2 Indicator actuator full face illumination page 6 | Indicator actuator front illumination page 6 | Illuminated actuator pushbutton page 8 | Mushroom-head actuator pushbutton page 9 | Illuminated mushroom-head actuator pushbutton page 10 | Keylock switch 2 positions page 11 | Selector switch 2 positions page 12 | Indicator actuator, flush mounting page 13 | Illuminated pushbutton actuator, flush mounting page 14 | Keylock switch actuator 2 positions, flush mounting page 15 | Selector switch actuator 2 positions, flush mounting page 16

Terminals (rearside)

PCB layout (conductor side)

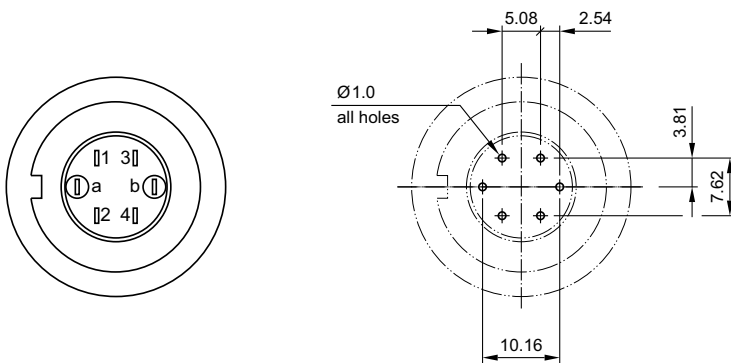

### 3 PCB plug-in base page 22

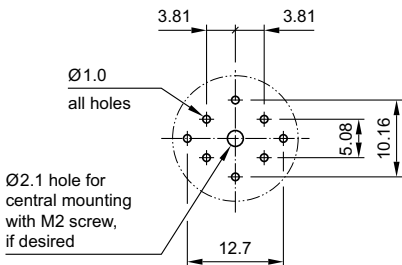

## 4 PCB plug-in base page 22

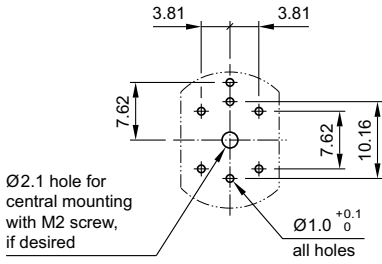

## Mounting dimensions

**1 Indicator actuator, flush mounting** page 13 | **Buzzer, flush mounting** page 13 | **Illuminated pushbutton actuator, flush mounting** page 14 | **Keylock switch actuator 2 positions, flush mounting** page 15 | **Selector switch actuator 2 positions, flush mounting** page 16 | **Front bezel set, flush mounting** page 20

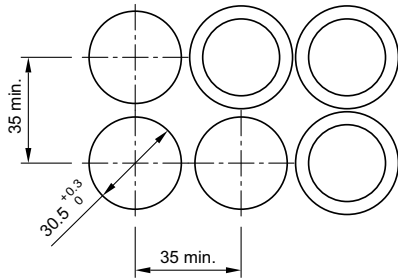

Hole spacing 37 mm min. by using blind plug 704.960.8

**2 Mushroom-head actuator pushbutton** page 9 | **Illuminated mushroom-head actuator pushbutton** page 10

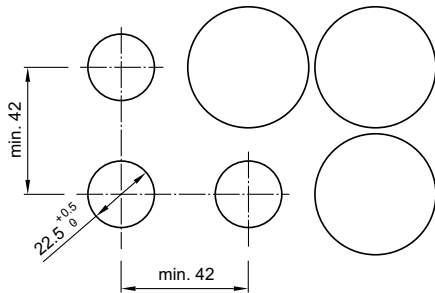

**3 Positioning insert** page 25

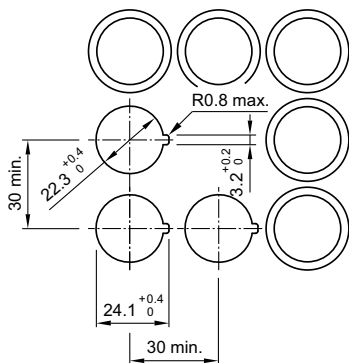

## 4 Front bezel set for Mushroom-head pushbutton page 19

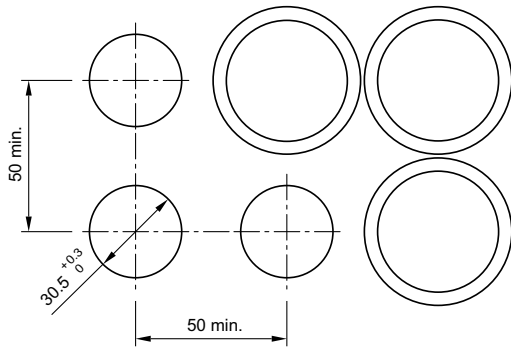

## 5 Indicator actuator full face illumination page 6 | Indicator actuator front illumination page 6 | Buzzer page 7 | Illuminated actuator pushbutton page 8 | Keylock switch 2 positions page 11 | Selector switch 2 positions page 12

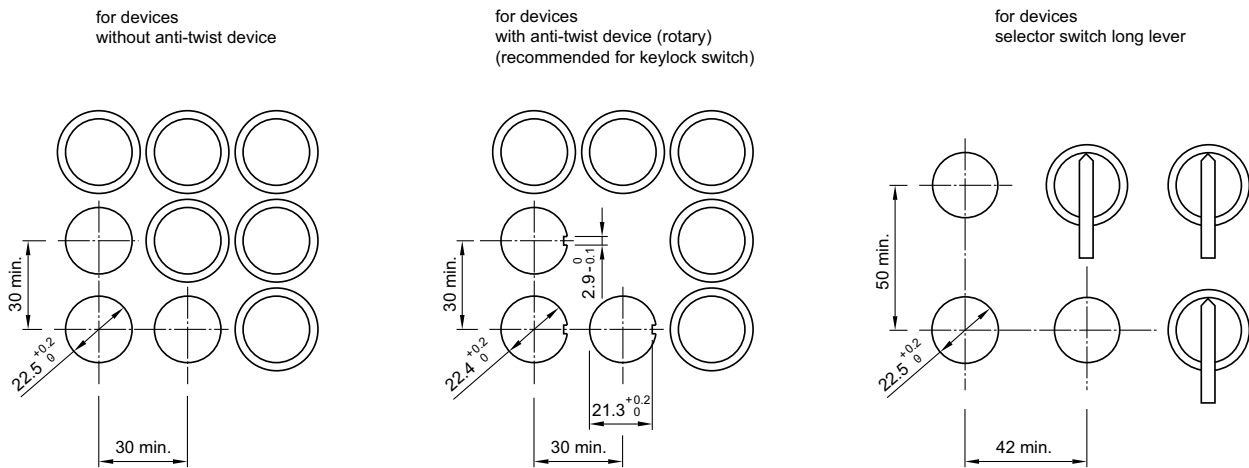

Hole spacing 31 mm min. by using blind plug 704.960.4

## Technical drawing

### 1 Buzzer page 7

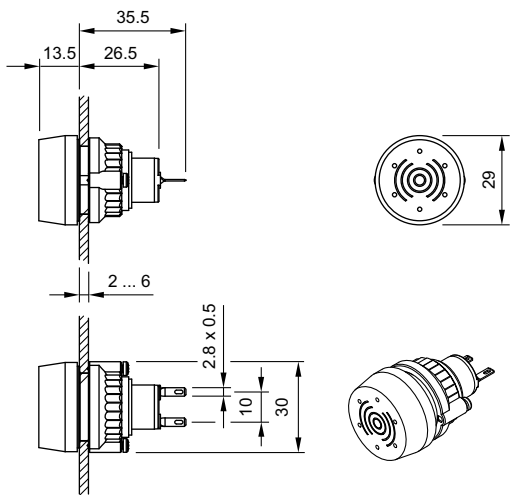



## 2 Blind plug page 22

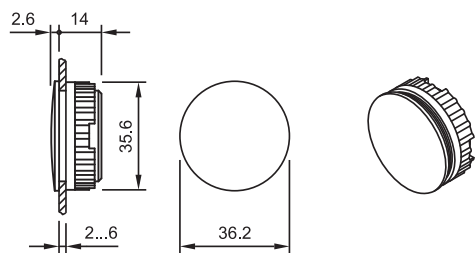

## 3 Blind plug page 22

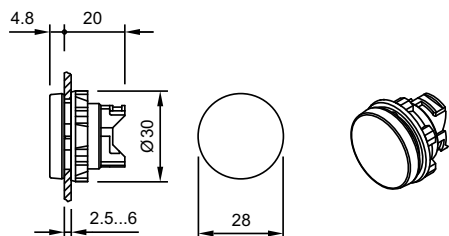

## 4 Protective cover, raised mounting page 20

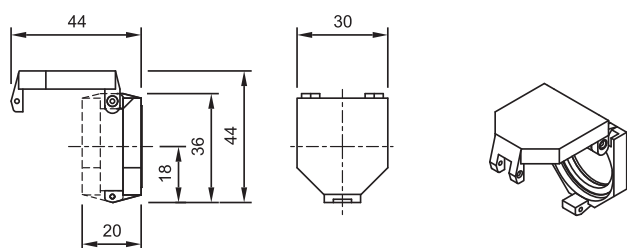

Front panel thickness reduces by 3.5 mm to max. 4.5 mm

## 5 Protective cover, flush mounting page 21

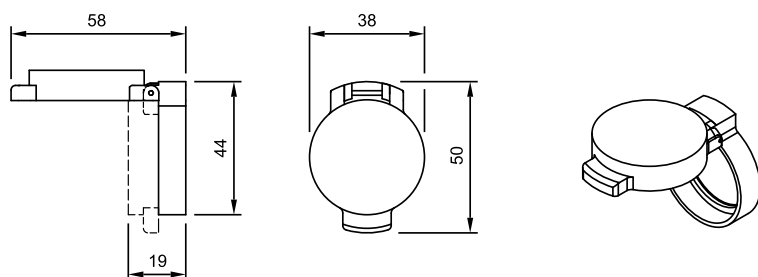

Front panel thickness reduces by 2.5 mm to max. 3.5 mm

## 6 Protective cover, raised mounting page 20

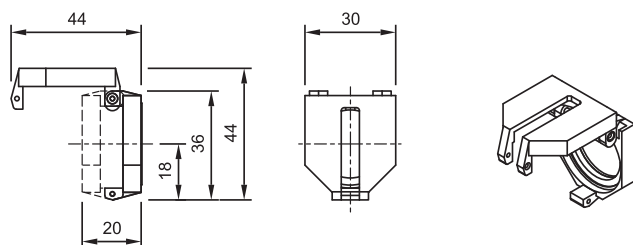

Front panel thickness reduces by 3.5 mm to max. 4.5 mm

## 7 Protective cover, flush mounting page 21

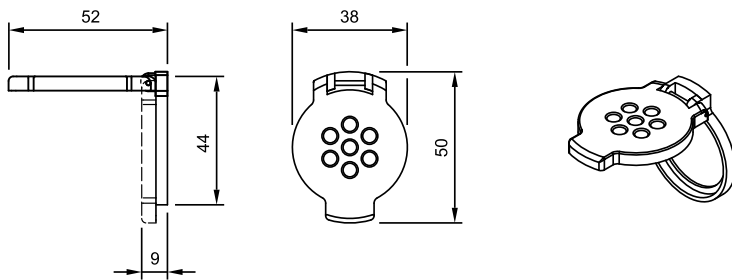

Front panel thickness reduces by 2.5 mm to max. 3.5 mm

## 8 Protective cover, flush mounting page 21

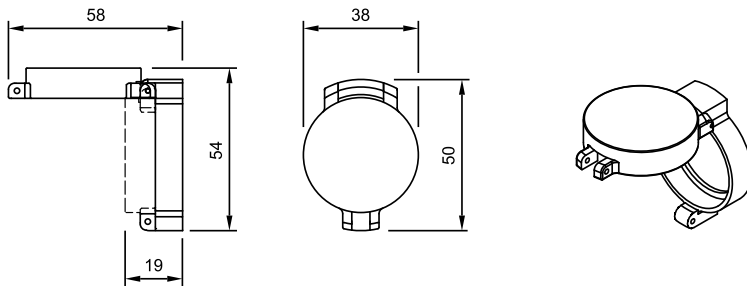

Front panel thickness reduces by 2.5 mm to max. 3.5 mm

## 9 Legend frame page 20

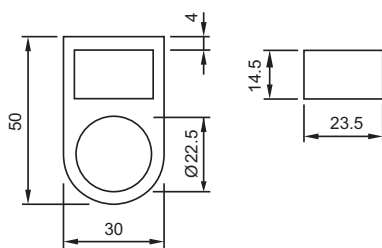

## 10 Legend frame page 20

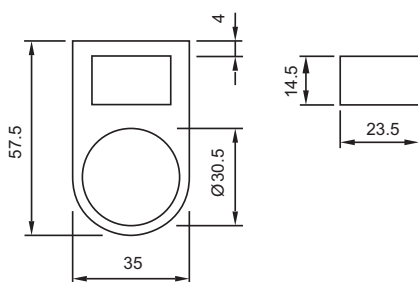

11 Enclosure page 26

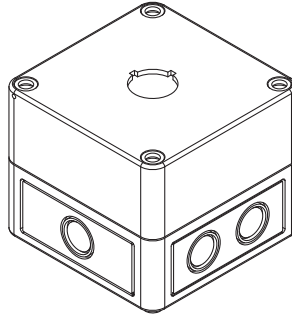
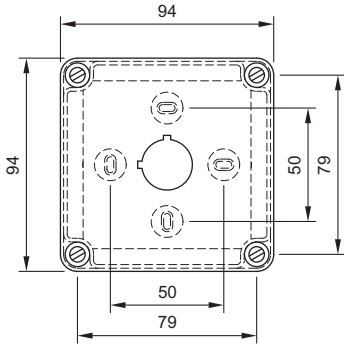
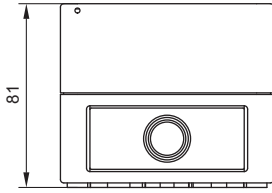

12 Enclosure page 26

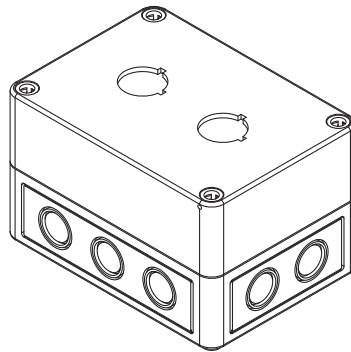
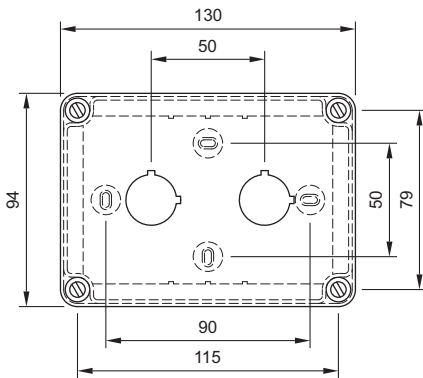
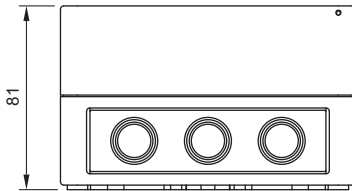

13 Enclosure page 26

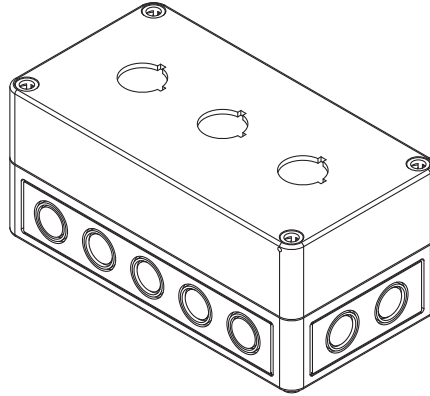
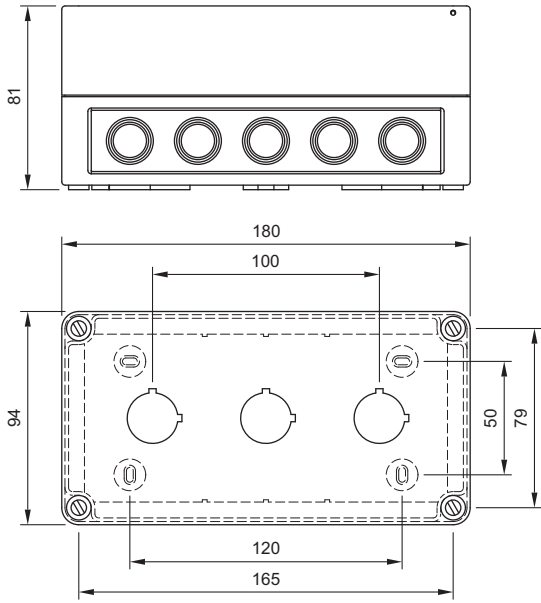

14 Enclosure page 26

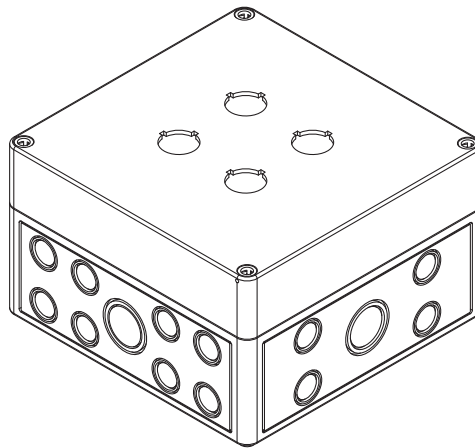
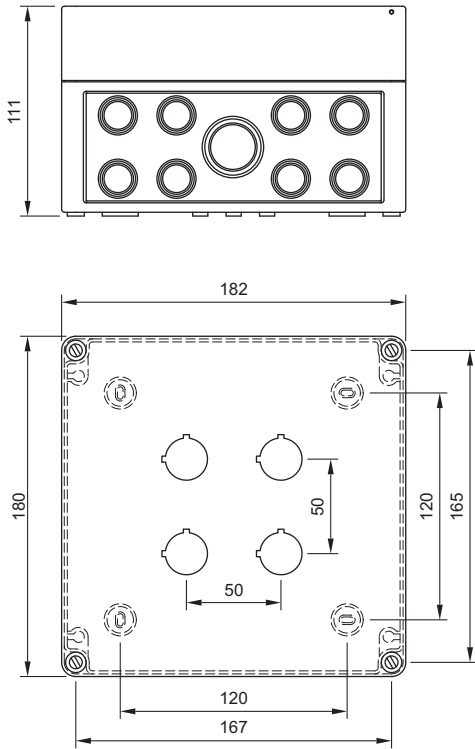

15 Enclosure page 26

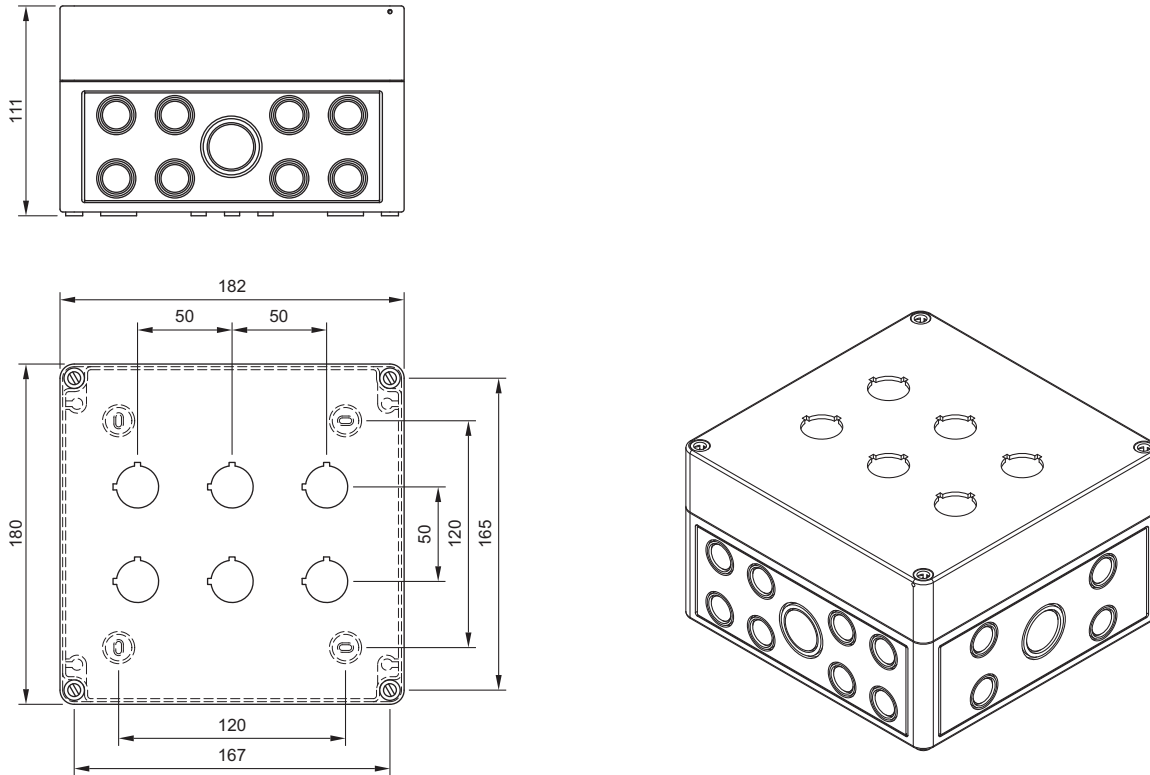

16 Buzzer, flush mounting page 13

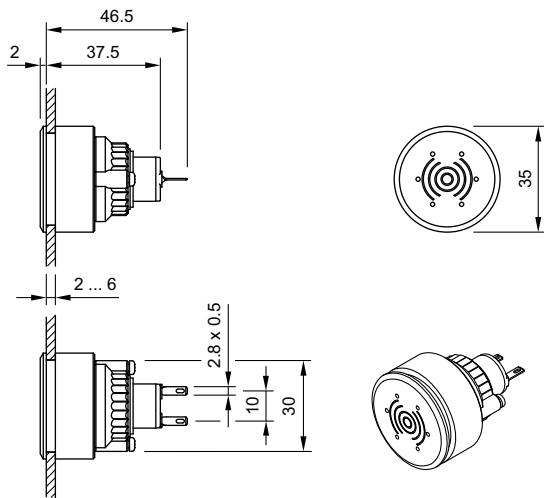

## 17 Indicator actuator full face illumination page 6

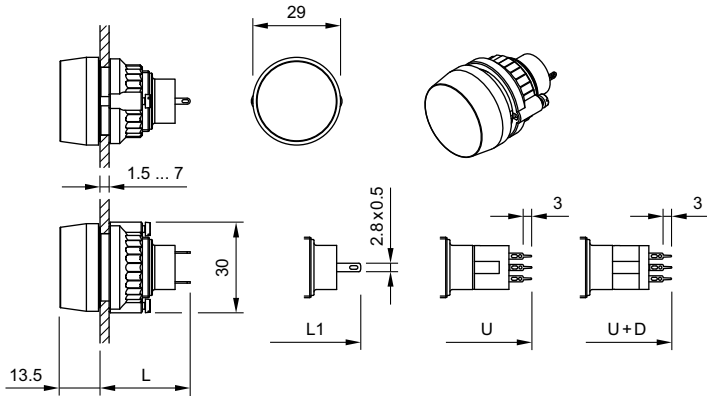

Soldering terminal		Soldering terminal (also pluggable)		Universal terminal	Universal terminal + diodes
L	L1	U	U+D		
30	33	44.5	-		
1D, 2D			44.5		

## 18 Mushroom-head actuator pushbutton page 9 | Illuminated mushroom-head actuator pushbutton page 10

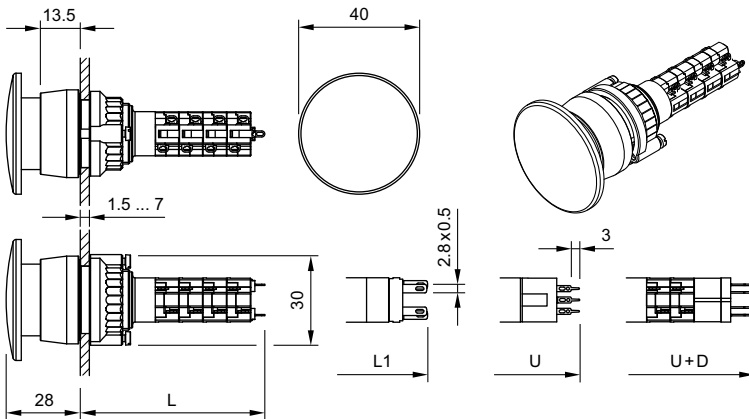

	Soldering terminal		Soldering terminal (also pluggable)		Universal terminal	Universal terminal + diode
	L	L1	U	U+D		
1NC+1NO	37.5	45.5	-	-		
2NC+2NO	45	-	-	-		
3NC+3NO	52.5	-	-	-		
4NC+4NO	60	-	-	-		
1NC+1NO+D	-	-	-	-	52	
2NC+2NO+D	-	-	-	-	60	
1NC, 1NO, 1NC+1NO, 2NC, 2NO	44.5			-		

## 19 Indicator actuator front illumination page 6

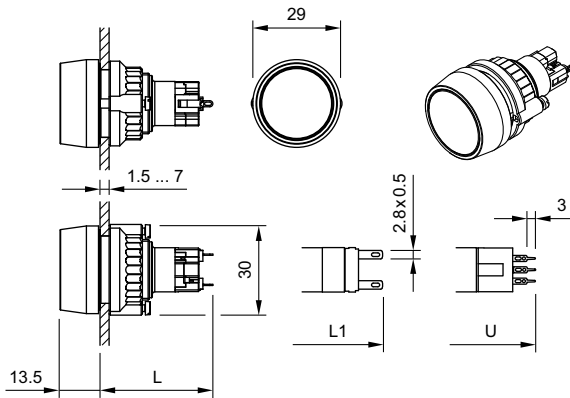

Soldering terminal		Soldering terminal (also pluggable)		Universal terminal
L	L1	U		
37.5	45.5	44.5		

## 20 Illuminated actuator pushbutton page 8

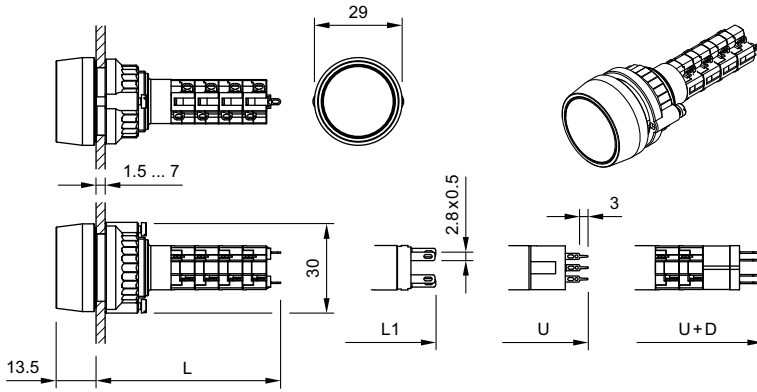

	Soldering terminal	Soldering terminal (also pluggable)	Universal terminal	Universal terminal + diode
	L	L1	U	U+D
1NC+1NO	37.5	45.5	-	-
2NC+2NO	45	-	-	-
3NC+3NO	52.5	-	-	-
4NC+4NO	60	-	-	-
1NC+1NO+D	-	-	-	52
2NC+2NO+D	-	-	-	60
1NC, 1NO, 1NC+1NO, 2NC, 2NO	44.5			-

## 21 Keylock switch 2 positions page 11

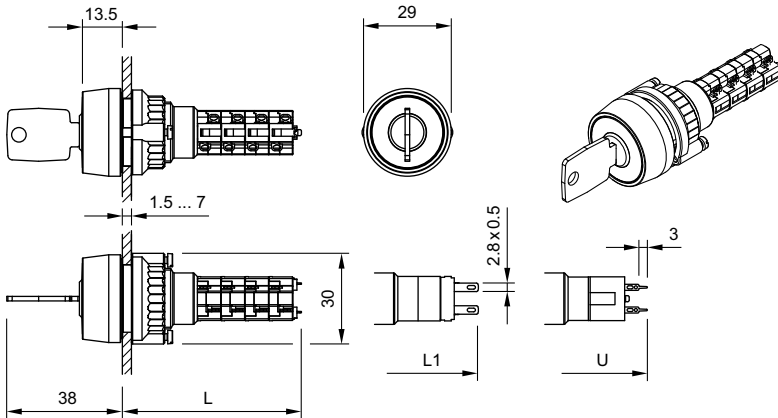

	Soldering terminal	Soldering terminal (also pluggable)	Universal terminal
	L	L1	U
1NC+1NO	35.5	45.5	-
2NC+2NO	43	-	-
3NC+3NO	50.5	-	-
4NC+4NO	58	-	-
1NC, 1NO, 1NC+1NO, 2NC, 2NO	44.5		

## 22 Selector switch 2 positions page 12

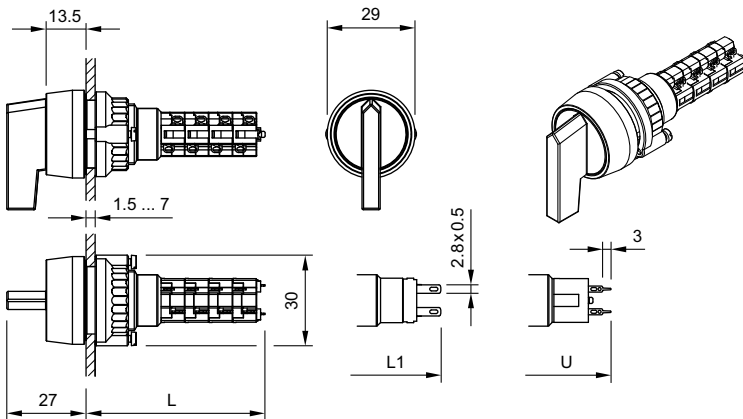

	Soldering terminal	Soldering terminal (also pluggable)	Universal terminal
	L	L1	U
1NC+1NO	35.5	45.5	-
2NC+2NO	43	-	-
3NC+3NO	50.5	-	-
4NC+4NO	58	-	-
1NC, 1NO, 1NC+1NO, 2NC, 2NO	44.5		

23 Selector switch 2 positions page 12

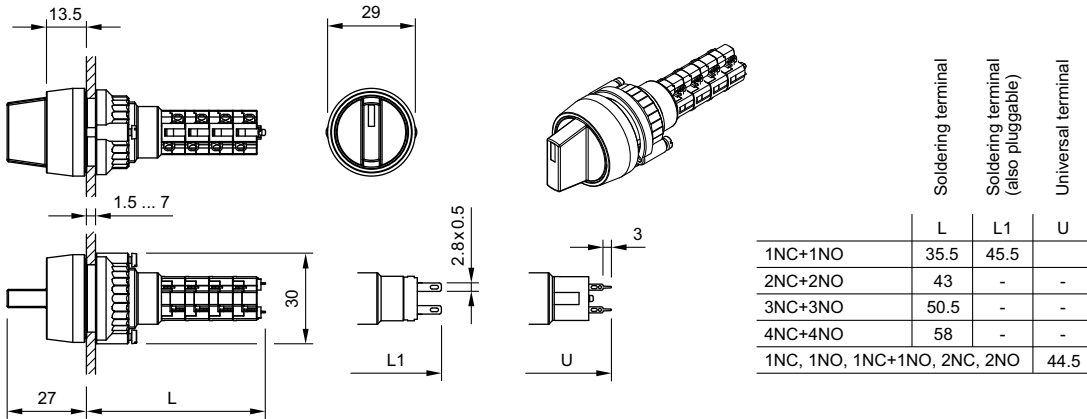

24 Indicator actuator, flush mounting page 13

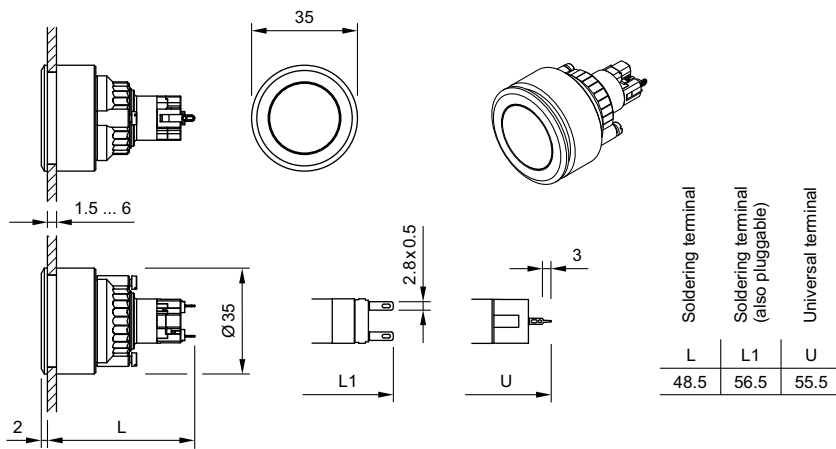

25 Illuminated pushbutton actuator, flush mounting page 14

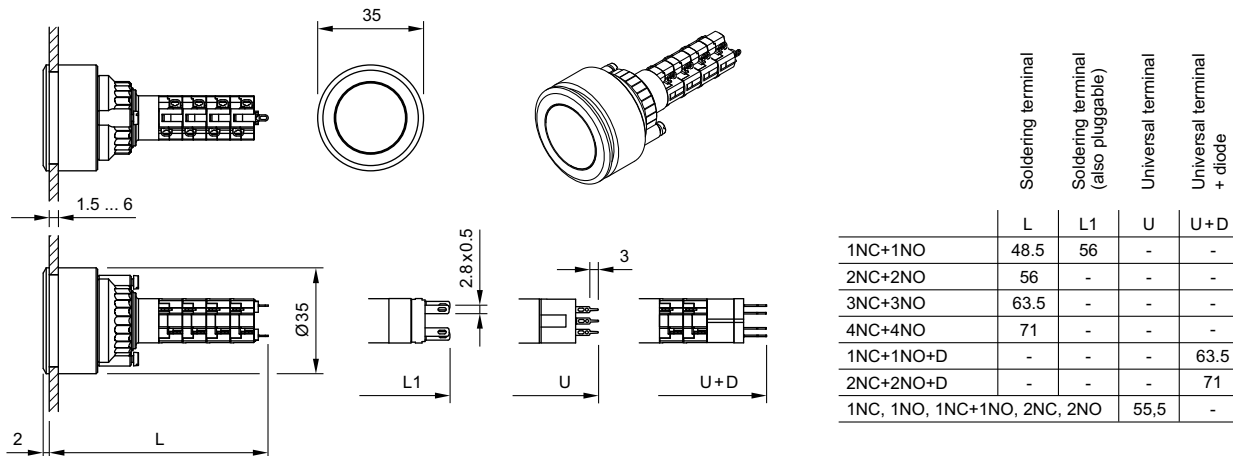



26 Keylock switch actuator 2 positions, flush mounting page 15

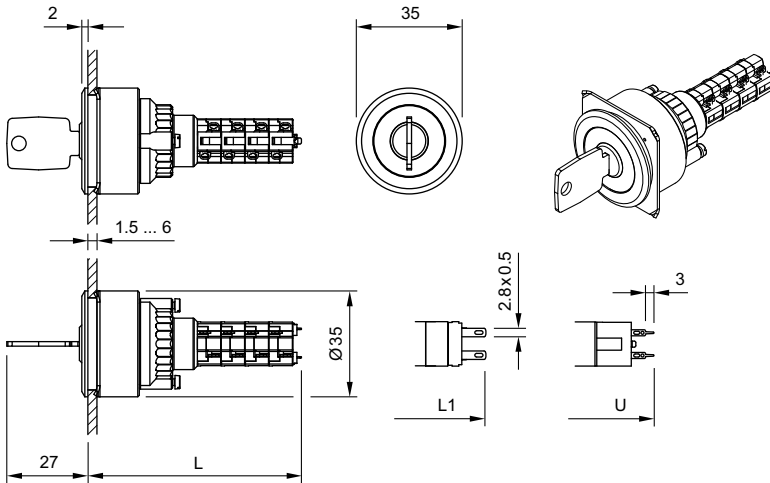

	Soldering terminal	Soldering terminal (also pluggable)	Universal terminal
	L	L1	U
1NC+1NO	46.5	56	-
2NC+2NO	54	-	-
3NC+3NO	61.5	-	-
4NC+4NO	69	-	-
1NC+1NO, 2NO			55.5

27 Selector switch actuator 2 positions, flush mounting page 16

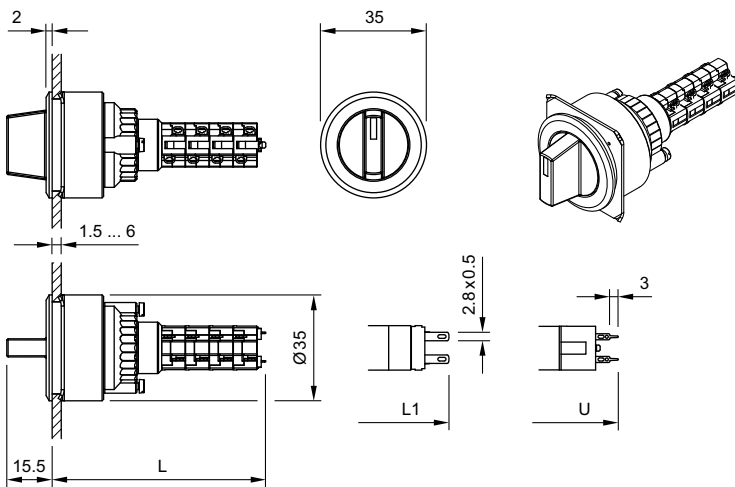

	Soldering terminal	Soldering terminal (also pluggable)	Universal terminal
	L	L1	U
1NC+1NO	46.5	56	-
2NC+2NO	54	-	-
3NC+3NO	61.5	-	-
4NC+4NO	69	-	-
1NC+1NO, 2NC, 2NO			55.5

28 Front bezel set for Mushroom-head pushbutton page 19

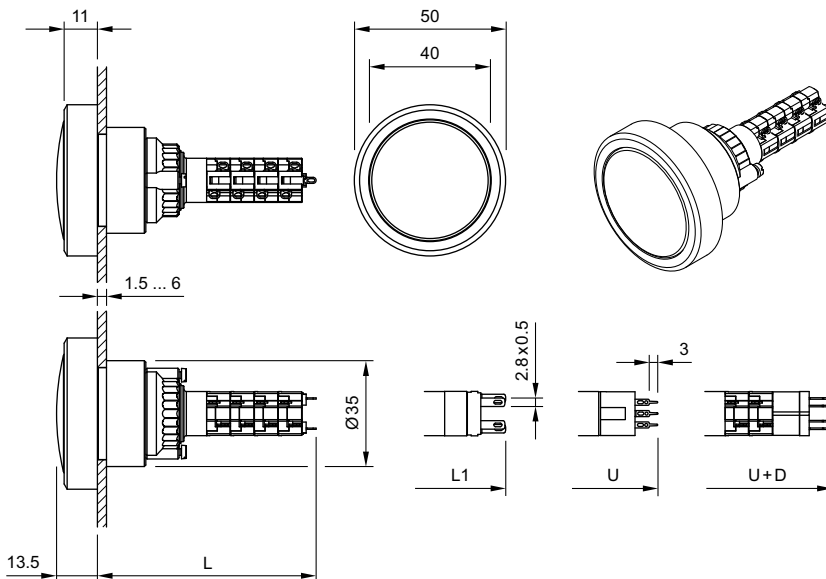

	Soldering terminal	Soldering terminal (also pluggable)	Universal terminal	Universal terminal + diode
	L	L1	U	U+D
1NC+1NO	48.5	56	-	-
2NC+2NO	56	-	-	-
3NC+3NO	63.5	-	-	-
4NC+4NO	71	-	-	-
1NC+1NO+D	-	-	-	63.5
2NC+2NO+D	-	-	-	71
1NC, 1NO, 1NC+1NO, 2NC, 2NO			55.5	-

## Circuit drawing

1 Buzzer page 7 | Buzzer, flush mounting page 13

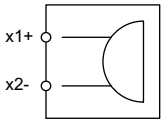

2 Indicator actuator full face illumination page 6 | Indicator actuator front illumination page 6 | Indicator actuator, flush mounting page 13

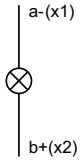

3 Indicator actuator full face illumination page 6 | Indicator actuator front illumination page 6 | Indicator actuator, flush mounting page 13



4 Illuminated actuator pushbutton page 8 | Mushroom-head actuator pushbutton page 9 | Illuminated mushroom-head actuator pushbutton page 10 | Illuminated pushbutton actuator, flush mounting page 14

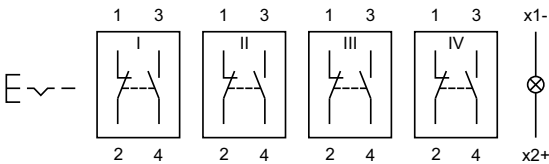

5 Illuminated actuator pushbutton page 8 | Mushroom-head actuator pushbutton page 9 | Illuminated mushroom-head actuator pushbutton page 10 | Illuminated pushbutton actuator, flush mounting page 14

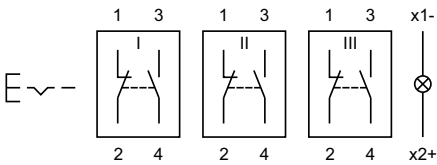

6 Illuminated actuator pushbutton page 8 | Illuminated mushroom-head actuator pushbutton page 10 | Illuminated pushbutton actuator, flush mounting page 14

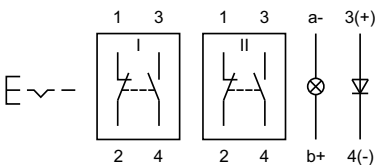

7 Illuminated actuator pushbutton page 8 | Illuminated mushroom-head actuator pushbutton page 10 | Illuminated pushbutton actuator, flush mounting page 14

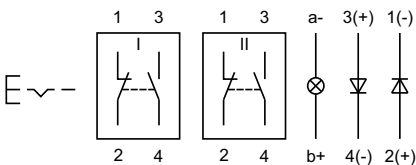

**8 Illuminated actuator pushbutton** page 8 | **Mushroom-head actuator pushbutton** page 9 | **Illuminated mushroom-head actuator pushbutton** page 10 | **Illuminated pushbutton actuator, flush mounting** page 14

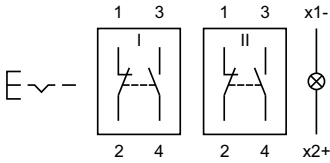

**9 Illuminated actuator pushbutton** page 8 | **Illuminated mushroom-head actuator pushbutton** page 10 | **Illuminated pushbutton actuator, flush mounting** page 14

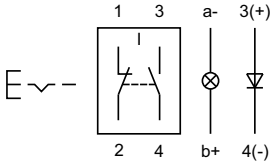

**10 Illuminated actuator pushbutton** page 8 | **Illuminated mushroom-head actuator pushbutton** page 10 | **Illuminated pushbutton actuator, flush mounting** page 14

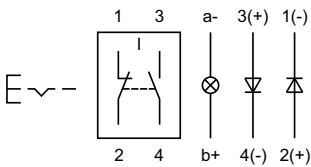

**11 Illuminated actuator pushbutton** page 8 | **Mushroom-head actuator pushbutton** page 9 | **Illuminated mushroom-head actuator pushbutton** page 10 | **Illuminated pushbutton actuator, flush mounting** page 14

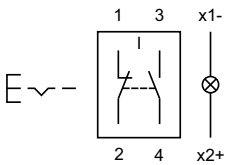

**12 Illuminated actuator pushbutton** page 8 | **Mushroom-head actuator pushbutton** page 9 | **Illuminated mushroom-head actuator pushbutton** page 10 | **Illuminated pushbutton actuator, flush mounting** page 14

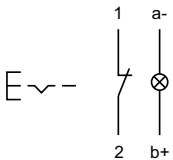

**13 Illuminated actuator pushbutton** page 8 | **Mushroom-head actuator pushbutton** page 9 | **Illuminated mushroom-head actuator pushbutton** page 10 | **Illuminated pushbutton actuator, flush mounting** page 14

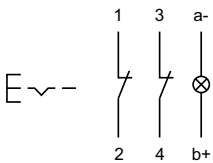

**14 Illuminated actuator pushbutton** page 8 | **Mushroom-head actuator pushbutton** page 9 | **Illuminated mushroom-head actuator pushbutton** page 10 | **Illuminated pushbutton actuator, flush mounting** page 14

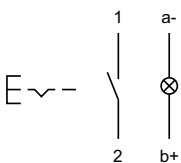

15 Illuminated actuator pushbutton page 8 | Mushroom-head actuator pushbutton page 9 | Illuminated mushroom-head actuator pushbutton page 10 | Illuminated pushbutton actuator, flush mounting page 14

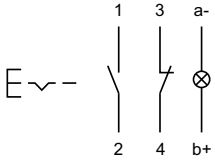

16 Illuminated actuator pushbutton page 8 | Mushroom-head actuator pushbutton page 9 | Illuminated mushroom-head actuator pushbutton page 10 | Illuminated pushbutton actuator, flush mounting page 14

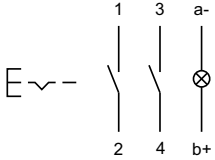

17 Selector switch 2 positions page 12 | Selector switch actuator 2 positions, flush mounting page 16

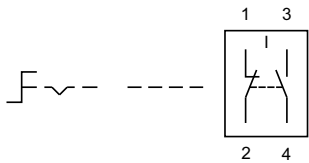

18 Selector switch 2 positions page 12 | Selector switch actuator 2 positions, flush mounting page 16

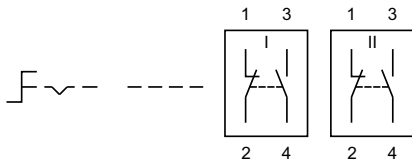

19 Selector switch 2 positions page 12 | Selector switch actuator 2 positions, flush mounting page 16

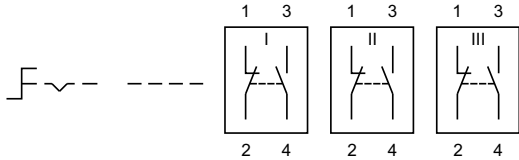

20 Selector switch 2 positions page 12 | Selector switch actuator 2 positions, flush mounting page 16

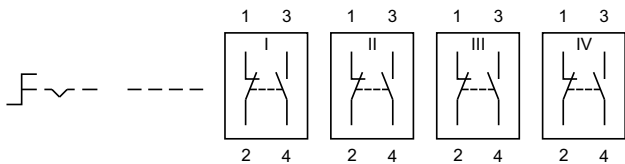

21 Selector switch 2 positions page 12 | Selector switch actuator 2 positions, flush mounting page 16

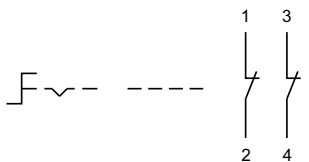

22 Selector switch 2 positions page 12 | Selector switch actuator 2 positions, flush mounting page 16



23 Selector switch 2 positions page 12 | Selector switch actuator 2 positions, flush mounting page 16

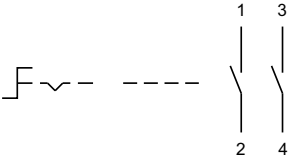

24 Selector switch 2 positions page 12 | Selector switch actuator 2 positions, flush mounting page 16

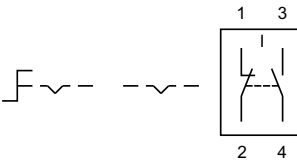

25 Selector switch 2 positions page 12 | Selector switch actuator 2 positions, flush mounting page 16

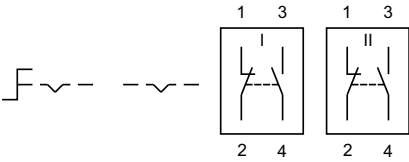

26 Selector switch 2 positions page 12 | Selector switch actuator 2 positions, flush mounting page 16

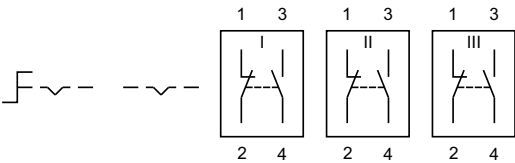

27 Selector switch 2 positions page 12 | Selector switch actuator 2 positions, flush mounting page 16

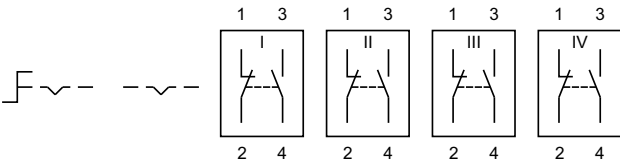

28 Selector switch 2 positions page 12 | Selector switch actuator 2 positions, flush mounting page 16

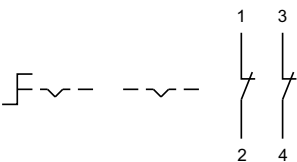

29 Selector switch 2 positions page 12 | Selector switch actuator 2 positions, flush mounting page 16

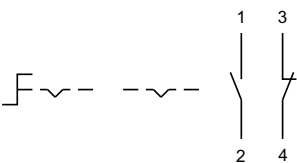

30 Selector switch 2 positions page 12 | Selector switch actuator 2 positions, flush mounting page 16

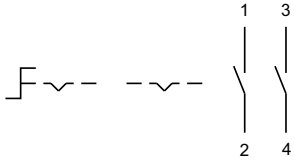

31 Illuminated actuator pushbutton page 8 | Mushroom-head actuator pushbutton page 9 | Illuminated mushroom-head actuator pushbutton page 10 | Illuminated pushbutton actuator, flush mounting page 14

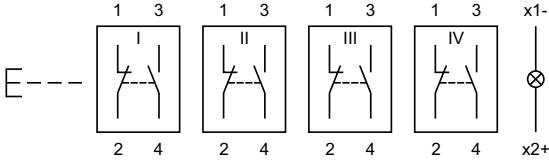

32 Illuminated actuator pushbutton page 8 | Mushroom-head actuator pushbutton page 9 | Illuminated mushroom-head actuator pushbutton page 10 | Illuminated pushbutton actuator, flush mounting page 14

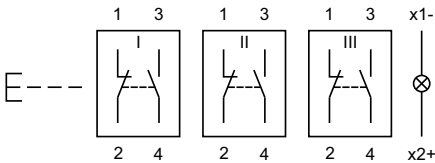

33 Illuminated actuator pushbutton page 8 | Illuminated mushroom-head actuator pushbutton page 10 | Illuminated pushbutton actuator, flush mounting page 14

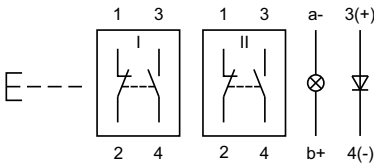

34 Illuminated actuator pushbutton page 8 | Illuminated mushroom-head actuator pushbutton page 10 | Illuminated pushbutton actuator, flush mounting page 14

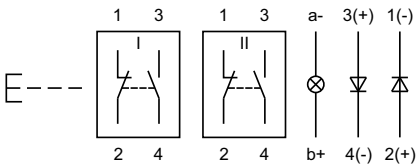

35 Illuminated actuator pushbutton page 8 | Mushroom-head actuator pushbutton page 9 | Illuminated mushroom-head actuator pushbutton page 10 | Illuminated pushbutton actuator, flush mounting page 14

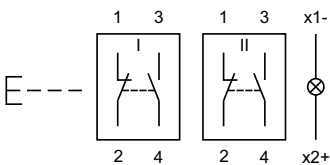

36 Illuminated actuator pushbutton page 8 | Illuminated mushroom-head actuator pushbutton page 10 | Illuminated pushbutton actuator, flush mounting page 14

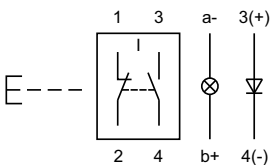

**37 Illuminated actuator pushbutton** page 8 | **Illuminated mushroom-head actuator pushbutton** page 10 | **Illuminated pushbutton actuator, flush mounting** page 14

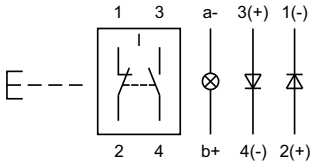

**38 Illuminated actuator pushbutton** page 8 | **Mushroom-head actuator pushbutton** page 9 | **Illuminated mushroom-head actuator pushbutton** page 10 | **Illuminated pushbutton actuator, flush mounting** page 14

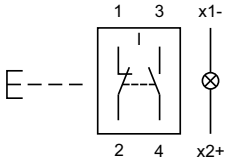

**39 Illuminated actuator pushbutton** page 8 | **Mushroom-head actuator pushbutton** page 9 | **Illuminated mushroom-head actuator pushbutton** page 10 | **Illuminated pushbutton actuator, flush mounting** page 14

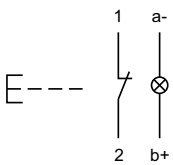

**40 Illuminated actuator pushbutton** page 8 | **Mushroom-head actuator pushbutton** page 9 | **Illuminated mushroom-head actuator pushbutton** page 10 | **Illuminated pushbutton actuator, flush mounting** page 14

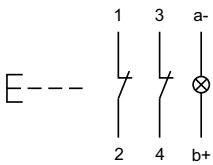

**41 Illuminated actuator pushbutton** page 8 | **Mushroom-head actuator pushbutton** page 9 | **Illuminated mushroom-head actuator pushbutton** page 10 | **Illuminated pushbutton actuator, flush mounting** page 14

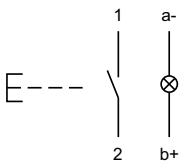

**42 Illuminated actuator pushbutton** page 8 | **Mushroom-head actuator pushbutton** page 9 | **Illuminated mushroom-head actuator pushbutton** page 10 | **Illuminated pushbutton actuator, flush mounting** page 14

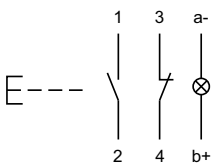

**43 Illuminated actuator pushbutton** page 8 | **Mushroom-head actuator pushbutton** page 9 | **Illuminated mushroom-head actuator pushbutton** page 10 | **Illuminated pushbutton actuator, flush mounting** page 14

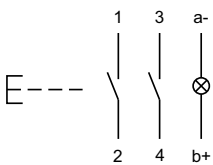

44 Keylock switch 2 positions page 11 | Keylock switch actuator 2 positions, flush mounting page 15

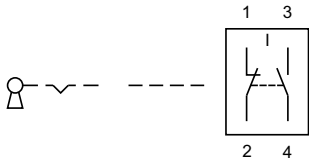

45 Keylock switch 2 positions page 11 | Keylock switch actuator 2 positions, flush mounting page 15

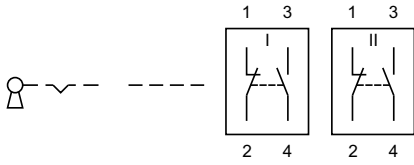

46 Keylock switch 2 positions page 11 | Keylock switch actuator 2 positions, flush mounting page 15

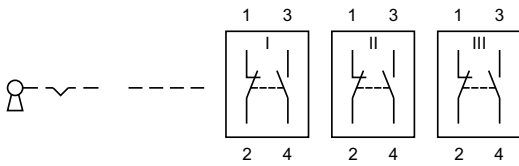

47 Keylock switch 2 positions page 11 | Keylock switch actuator 2 positions, flush mounting page 15

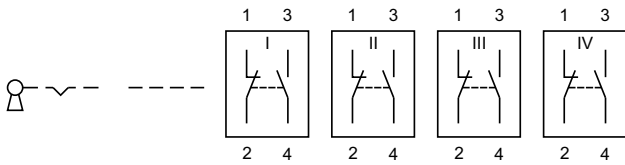

48 Keylock switch 2 positions page 11 | Keylock switch actuator 2 positions, flush mounting page 15

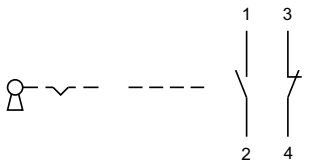

49 Keylock switch 2 positions page 11 | Keylock switch actuator 2 positions, flush mounting page 15

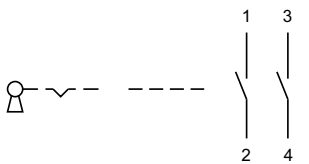

50 Keylock switch 2 positions page 11 | Keylock switch actuator 2 positions, flush mounting page 15

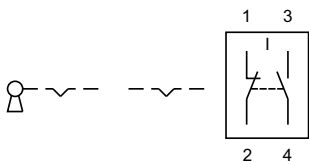

51 Keylock switch 2 positions page 11 | Keylock switch actuator 2 positions, flush mounting page 15

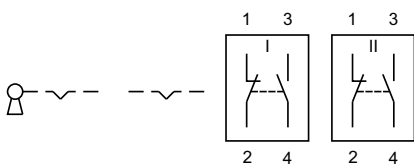



52 Keylock switch 2 positions page 11 | Keylock switch actuator 2 positions, flush mounting page 15

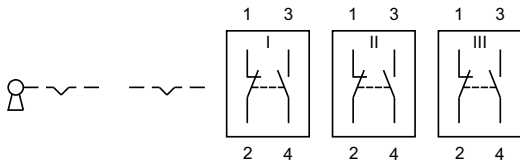

53 Keylock switch 2 positions page 11 | Keylock switch actuator 2 positions, flush mounting page 15

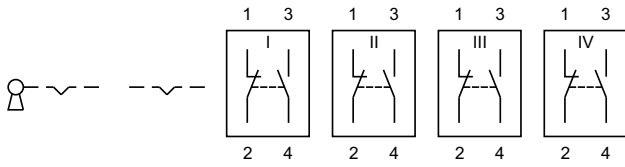

54 Keylock switch 2 positions page 11 | Keylock switch actuator 2 positions, flush mounting page 15

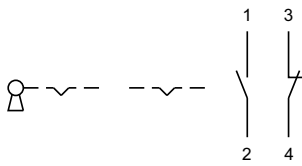

55 Keylock switch 2 positions page 11 | Keylock switch actuator 2 positions, flush mounting page 15

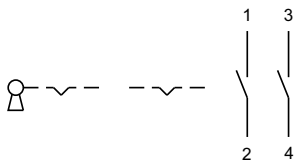

56 Indicator actuator full face illumination page 6

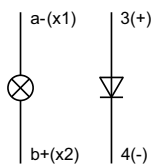

57 Indicator actuator full face illumination page 6

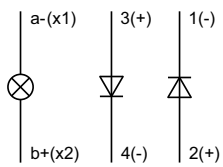

# Index from Typ-Nr.

Typ-Nr.	Page	Typ-Nr.	Page	Typ-Nr.	Page
01-928	23	14-133.0252	14	14-337.025K2	11
01-929	23	14-133.0252	8	14-337.025K2	15
02-906	25	14-133.0252	9	14-338.025K2	11
02-912.1	24	14-134.0252	10	14-338.025K2	15
02-912.2	24	14-134.0252	14	14-411.036K	11
02-912.3	24	14-134.0252	8	14-411.036K	15
02-912.4	24	14-134.0252	9	14-412.036K	11
10-1106.1369	23	14-135.022K	11	14-412.036K	15
10-1109.1279	23	14-135.022K	15	14-414.036K	11
10-1109.1329	23	14-135.025K2	11	14-414.036K	15
10-1112.1199	23	14-135.025K2	15	14-415.036K	11
10-1112.1279	23	14-136.025K2	11	14-415.036K	15
10-1113.1249	23	14-136.025K2	15	14-417.036K	11
10-1114.1249	23	14-137.025K2	11	14-417.036K	15
10-1116.1229	23	14-137.025K2	15	14-418.036K	11
10-1119.1199	23	14-138.025K2	11	14-418.036K	15
10-2106.3142	24	14-138.025K2	15	14-431.036	10
10-2106.3144	24	14-141.022K	11	14-431.036	14
10-2106.3145	24	14-141.022K	15	14-431.036	8
10-2106.3146	24	14-141.025K2	11	14-431.036	9
10-2106.3149	24	14-141.025K2	15	14-432.036	10
10-2109.1062	24	14-142.025K2	11	14-432.036	14
10-2109.1064	24	14-142.025K2	15	14-432.036	8
10-2109.1065	24	14-143.025K2	11	14-432.036	9
10-2109.1066	24	14-143.025K2	15	14-433.036	10
10-2109.1069	24	14-144.025K2	11	14-433.036	14
10-2112.1062	24	14-144.025K2	15	14-433.036	8
10-2112.1064	24	14-235.022K	11	14-433.036	9
10-2112.1065	24	14-235.022K	15	14-435.036	10
10-2112.1066	24	14-235.025K2	11	14-435.036	14
10-2112.1069	24	14-235.025K2	15	14-435.036	8
10-2113.1062	24	14-236.025K2	11	14-435.036	9
10-2113.1064	24	14-236.025K2	15	14-436.036	10
10-2113.1065	24	14-237.025K2	11	14-436.036	14
10-2113.1066	24	14-237.025K2	15	14-436.036	8
10-2113.1069	24	14-238.025K2	11	14-436.036	9
10-2119.1042	24	14-238.025K2	15	14-437.036K	11
10-2119.1044	24	14-271.022	10	14-437.036K	15
10-2119.1045	24	14-271.022	14	14-438.036K	11
10-2119.1046	24	14-271.022	8	14-438.036K	15
10-2119.1049	24	14-271.022	9	14-471.036	10
14-030.002	6	14-271.0252	10	14-471.036	14
14-030.005	6	14-271.0252	14	14-471.036	8
14-031.006	6	14-271.0252	8	14-471.036	9
14-040.002	13	14-271.0252	9	14-472.036	10
14-040.002	6	14-272.0252	10	14-472.036	14
14-040.005	13	14-272.0252	14	14-472.036	8
14-040.005	6	14-272.0252	8	14-472.036	9
14-041.006	13	14-272.0252	9	14-473.036	10
14-041.006	6	14-273.0252	10	14-473.036	14
14-131.022	10	14-273.0252	14	14-473.036	8
14-131.022	14	14-273.0252	8	14-473.036	9
14-131.022	8	14-273.0252	9	14-475.036	10
14-131.022	9	14-274.0252	10	14-475.036	14
14-131.0252	10	14-274.0252	14	14-475.036	8
14-131.0252	14	14-274.0252	8	14-475.036	9
14-131.0252	8	14-274.0252	9	14-476.036	10
14-131.0252	9	14-335.022K	11	14-476.036	14
14-132.0252	10	14-335.022K	15	14-476.036	8
14-132.0252	14	14-335.025K2	11	14-476.036	9
14-132.0252	8	14-335.025K2	15	14-501.0220	12
14-132.0252	9	14-336.025K2	11	14-501.0220	16
14-133.0252	10	14-336.025K2	15	14-501.02502	12

# Index from Typ-Nr.

Typ-Nr.	Page	Typ-Nr.	Page	Typ-Nr.	Page
14-501.02502	16	14-748.0292	14	704.608.9	19
14-502.02502	12	14-748.0292	8	704.609.0	18
14-502.02502	16	14-749.0292	10	704.609.7	18
14-503.02502	12	14-749.0292	14	704.609.9	18
14-503.02502	16	14-749.0292	8	704.609.9	18
14-504.02502	12	14-750.0292	10	704.610.7	19
14-504.02502	16	14-750.0292	14	704.610.9	19
14-506.0220	12	14-750.0292	8	704.611.2	17
14-506.0220	16	14-810.002	7	704.611.4	17
14-506.02502	12	14-810.902	7	704.611.5	17
14-506.02502	16	14-810.910	13	704.611.7	17
14-507.02502	12	14-810.918	13	704.614.2	18
14-507.02502	16	14-910	25	704.614.4	18
14-508.02502	12	14-958.0	19	704.614.5	18
14-508.02502	16	14-958.8	19	704.614.6	18
14-509.02502	12	14-987.1001	22	704.614.7	18
14-509.02502	16	31-928	23	704.925.0	20
14-515.0360	12	31-929	23	704.925.2	20
14-515.0360	16	31-940	22	704.925.3	20
14-516.0360	12	31-941	22	704.928.18	21
14-516.0360	16	31-942	22	704.928.28	21
14-517.0360	12	31-945	22	704.928.38	21
14-517.0360	16	31-946	22	704.945.1	26
14-520.0360	12	61-9481.6	26	704.945.2	26
14-520.0360	16	700.006.0	25	704.945.3	26
14-521.0360	12	704.600.0	19	704.945.4	26
14-521.0360	16	704.600.1	19	704.945.5	26
14-522.0360	12	704.600.1A	19	704.945.6	26
14-522.0360	16	704.600.2	21	704.953.0	21
14-551.0220	12	704.600.3	21	704.954.0	25
14-551.02502	12	704.600.5/A	21	704.955.0	20
14-552.02502	12	704.600.6	19	704.955.1	20
14-553.02502	12	704.600.9	19	704.955.3	21
14-554.02502	12	704.601.0	17	704.955.4	21
14-556.0220	12	704.601.01	17	704.955.9	20
14-556.02502	12	704.601.2	17	704.955.9E	21
14-557.02502	12	704.601.21	17	704.960.0	25
14-558.02502	12	704.601.4	17	704.960.4	22
14-559.02502	12	704.601.41	17	704.960.8	25
14-565.0360	12	704.601.5	17	704.964.8	22
14-566.0360	12	704.601.51	17	704.968.0	20
14-567.0360	12	704.601.6	17	704.968.1	20
14-570.0360	12	704.601.61	17	704.968.2	20
14-571.0360	12	704.601.8	17	704.968.3	20
14-572.0360	12	704.601.81	17		
14-741.006	6	704.601.9	17		
14-742.006	6	704.601.91	17		
14-743.0292	10	704.602.0	17		
14-743.0292	14	704.602.2	17		
14-743.0292	8	704.602.4	17		
14-744.0292	10	704.602.5	17		
14-744.0292	14	704.602.6	17		
14-744.0292	8	704.602.7	17		
14-745.0292	10	704.603.2	18		
14-745.0292	14	704.603.4	18		
14-745.0292	8	704.603.5	18		
14-746.0292	10	704.603.6	18		
14-746.0292	14	704.603.7	18		
14-746.0292	8	704.604.0	18		
14-747.0292	10	704.604.2	18		
14-747.0292	14	704.604.4	18		
14-747.0292	8	704.604.5	18		
14-748.0292	10	704.608.7	19		

	<b>EAO AG</b>
	Tannwaldstrasse 88 4601 Olten, Switzerland
<b>E-mail</b>	info@eao.com
<b>Website</b>	www.eao.com
	<b>Austria</b>
Phone	+49 201 85 87 0
Fax	+49 201 85 87 210
E-mail	sales.ede@eao.com
	<b>Belgium</b>
Phone	+32 3 777 82 36
Fax	+32 3 777 84 19
E-mail	sales.ebl@eao.com
	<b>China</b>
Phone	+852 27 86 91 41
Fax	+852 27 86 95 61
E-mail	sales.ehk@eao.com
	<b>France</b>
Phone	+33 1 64 43 37 37
Fax	+33 1 64 43 37 49
E-mail	sales.esa@eao.com
	<b>Germany</b>
Phone	+49 201 85 87 0
Fax	+49 201 85 87 210
E-mail	sales.ede@eao.com
	<b>Italy</b>
Phone	+39 035 481 0189
Fax	+39 035 481 3786
E-mail	sales.eit@eao.com
	<b>Japan</b>
Phone	+81 3 5444 5411
Fax	+81 3 5444 0345
E-mail	sales.esj@eao.com
	<b>Netherlands</b>
Phone	+31 78 653 17 00
Fax	+31 78 653 17 99
E-mail	sales.enl@eao.com
	<b>Sweden</b>
Phone	+46 8 683 86 60
Fax	+46 8 724 29 12
E-mail	sales.esw@eao.com
	<b>Switzerland</b>
Phone	+41 62 388 95 00
Fax	+41 62 388 95 55
E-mail	sales.ech@eao.com
	<b>United Kingdom</b>
Phone	+44 1444 236 000
Fax	+44 1444 236 641
E-mail	sales.euk@eao.com
	<b>USA</b>
Phone	+1 203 877 4577
Fax	+1 203 877 3694
E-mail	sales.eus@eao.com
	<b>Other Countries</b>
Phone	+41 62 286 92 10
Fax	+41 62 296 21 62
E-mail	info@eao.com



Компания «ЭлектроПласт» предлагает заключение долгосрочных отношений при поставках импортных электронных компонентов на взаимовыгодных условиях!

Наши преимущества:

- Оперативные поставки широкого спектра электронных компонентов отечественного и импортного производства напрямую от производителей и с крупнейших мировых складов;
- Поставка более 17-ти миллионов наименований электронных компонентов;
- Поставка сложных, дефицитных, либо снятых с производства позиций;
- Оперативные сроки поставки под заказ (от 5 рабочих дней);
- Экспресс доставка в любую точку России;
- Техническая поддержка проекта, помощь в подборе аналогов, поставка прототипов;
- Система менеджмента качества сертифицирована по Международному стандарту ISO 9001;
- Лицензия ФСБ на осуществление работ с использованием сведений, составляющих государственную тайну;
- Поставка специализированных компонентов (Xilinx, Altera, Analog Devices, Intersil, Interpoint, Microsemi, Aeroflex, Peregrine, Syfer, Eurofarad, Texas Instrument, Miteq, Cobham, E2V, MA-COM, Hittite, Mini-Circuits, General Dynamics и др.);

Помимо этого, одним из направлений компании «ЭлектроПласт» является направление «Источники питания». Мы предлагаем Вам помощь Конструкторского отдела:

- Подбор оптимального решения, техническое обоснование при выборе компонента;
- Подбор аналогов;
- Консультации по применению компонента;
- Поставка образцов и прототипов;
- Техническая поддержка проекта;
- Защита от снятия компонента с производства.



#### Как с нами связаться

**Телефон:** 8 (812) 309 58 32 (многоканальный)

**Факс:** 8 (812) 320-02-42

**Электронная почта:** [org@eplast1.ru](mailto:org@eplast1.ru)

**Адрес:** 198099, г. Санкт-Петербург, ул. Калинина, дом 2, корпус 4, литера А.