

# MISCELLANEOUS HARDWARE & ACCESSORIES

SPECIFICATIONS SUBJECT TO CHANGE WITHOUT NOTICE

<b>SWITCH HARDWARE.....</b>	<b>D2 - D4</b>
<b>PUSHBUTTON AND TOGGLE CAPS.....</b>	<b>D5 - D6</b>
<b>SECURITY GUARDS.....</b>	<b>D7 - D9</b>
<b>SEALING BOOTS.....</b>	<b>D10 - D14</b>
<b>VL SERIES LED INDICATORS.....</b>	<b>D15 - D16</b>



# MISCELLANEOUS HARDWARE

**HEX NUT A112** Nickel plated brass  
1/4-40



**HEX NUT** Brass 1/4-40  
Nickel plated **U76** Matte black **U94**



**HEX NUT** Brass  
Nickel plated **U208** Matte black **U726**



**HEX NUT** Brass  
Chrome plated **U1916**



**HEX NUT U842** 10mm (.393")  
Nickel plated brass



**HEX NUT A465**  
Nickel plated brass 15/32-32



**HEX NUT** Brass 15/32-32  
Nickel plated **U162** Matte black **U41**  
Chrome plated **U92**



**HEX NUT** Brass 12mm (.472")  
Nickel plated **U166** Matte black **U183**  
Chrome plated **U212**



**HEX CAP NUT** Brass 12mm (.472")  
Chrome plated **U35**



**PAL NUT U42** 12mm (.472")  
Zinc plated steel



**HEX NUT 10-621** 16mm (.629")  
Nickel plated brass



**HEX NUT U1950-5** 19mm (.748")  
Nickel plated brass



**HEX NUT 10-855-5** 19mm (.748")  
Nickel plated brass



**HEX NUT U1951-5** 22mm (.866")  
Nickel plated brass



**HEX NUT 10-856-5** 22mm (.866")  
Nickel plated brass



**HEX NUT U2059-5** 24mm (.944")  
Nickel plated brass



**PANEL DRESS NUT A168P1**  
Blind thread, Nickel plated brass  
1/4-40



**PANEL DRESS NUT A168P2**  
Thru thread, Nickel plated brass  
1/4-40



**PANEL DRESS NUT A274**  
Nickel plated brass 1/4-40



**PANEL DRESS NUT A540**  
Nickel plated brass 15/32-32



SPECIFICATIONS SUBJECT TO CHANGE WITHOUT NOTICE

D

## MISCELLANEOUS HARDWARE (CONT'D.)

SPECIFICATIONS SUBJECT TO CHANGE WITHOUT NOTICE

D

<p><b>DECORATIVE NUT A447</b> Thru thread, chromium plated brass 1/4-40</p> 	<p><b>KNURLED NUT U369 1/4-40</b> Nickel plated brass</p> 	<p><b>KNURLED NUT U501 1/4-40</b> Chrome plated brass</p> 	<p><b>KNURLED NUT Brass 1/4-40</b> Nickel plated <b>U229</b> Matte black <b>U230</b></p> 
<p><b>KNURLED NUT U826</b> Nickel plated brass</p> 	<p><b>KNURLED CAP NUT Brass 1/4-40</b> Chrome plated <b>U216</b> Matte black <b>U218</b></p> 	<p><b>KNURLED CAP NUT Brass</b> Chrome pl. <b>U461</b> Matte black <b>U502</b></p> 	<p><b>KNURLED CAP NUT Brass</b> Chrome plated <b>U232</b></p> 
<p><b>KNURLED CAP NUT Brass 1/4-40</b> Chrome pl. <b>U268</b> Matte black <b>U725</b></p> 	<p><b>KNURLED NUT U2311 10mm (.393")</b> Chrome plated brass</p> 	<p><b>KNURLED CAP NUT U2220</b> 10mm (.393") Chrome plated brass</p> 	<p><b>KNURLED NUT Brass 15/32-32</b> Nickel plated <b>U53</b> Matte black <b>U1634</b></p> 
<p><b>KNURLED CAP NUT U123 15/32-32</b> Chrome plated brass</p> 	<p><b>KNURLED CAP NUT U124 15/32-32</b> Chrome plated brass</p> 	<p><b>PANEL DRESS NUT Brass 12mm (.472")</b> Nickel plated <b>U411</b>, Matte black <b>U413</b>, Chrome plated <b>U412</b></p> 	<p><b>KNURLED CAP NUT Brass 12mm (.472")</b> Chrome plated <b>U117</b> Matte black <b>U129</b></p> 
<p><b>KNURLED CAP NUT Brass 12mm (.472")</b> Chrome plated <b>U118</b> Matte black <b>U130</b></p> 	<p><b>INSULATED PANEL DRESS NUT</b> 12mm (.472") ABS or polyamide with glass fiber. blue <b>U521</b>, black <b>U522</b>, green <b>U523</b>, gray <b>U524</b>, yellow <b>U525</b>, red <b>U526</b>, white <b>U527/1</b>, orange <b>U529</b></p> 	<p><b>KNURLED NUT 10-960-5</b> 16mm (.629") Nickel plated brass</p> 	<p><b>KNURLED NUT U1977-5</b> 19mm (.748") Nickel plated brass</p> 

## MISCELLANEOUS HARDWARE (CONT'D.)

<p><b>LOCKWASHER U14</b> .122 I.D. Stainless steel</p> 	<p><b>LOCKWASHER 1/4</b> Stainless steel <b>U215</b></p> 	<p><b>LOCKWASHER A115</b> Nickel plated steel 1/4</p> 	<p><b>LOCKWASHER U843</b> 10mm (.393") Stainless steel</p> 
<p><b>LOCKWASHER A466</b> Nickel plated steel 15/32</p> 	<p><b>LOCKWASHER U13</b> 15/32 Zinc plated</p> 	<p><b>ANTI-ROTATE RING A107</b> Nickel plated brass 1/4</p> 	<p><b>LOCKING RING 1/4</b> Nickel plated <b>U78</b> Matte black <b>U93</b></p> 
<p><b>LOCKING RING</b> Brass Nickel plated <b>U198</b> Matte black <b>U728</b></p> 	<p><b>ANTI-ROTATE RING (LARGE) A158</b> Nickel plated brass 1/4</p> 	<p><b>LOCKING RING U844</b> 10mm (.393") Nickel plated</p> 	<p><b>ANTI-ROTATE RING A482</b> Nickel plated brass 15/32</p> 
<p><b>LOCKING RING</b> 12mm (.472") Nickel plated <b>U121</b> Matte black <b>U12</b></p> 	<p><b>SEALING WASHER U360</b> 1/4-40 For keyway bushing</p> 	<p><b>SEALING WASHER U60</b> 15/32</p> 	<p><b>SEALING WASHER</b> Nylon 12mm (.472") <b>U21</b></p> 
<p><b>GROUND CONNECTOR</b> 12mm (.472") Nickel plated <b>U187</b></p> 	<p><b>SWITCH PLATE I-O U1050</b> .480 I.D.</p> 	<p><b>SWITCH PLATE ON-OFF U19</b> .480 I.D.</p> 	<p><b>CONNECTING SCREW U03</b></p> 

SPECIFICATIONS SUBJECT TO CHANGE WITHOUT NOTICE

D

# MISCELLANEOUS PUSHBUTTON ACCESSORIES & CAPS

Note: additional caps are shown in some switch sections.

## PANEL DRESS NUTS & CAPS FOR PUSHBUTTON SWITCHES

ASSEMBLY NUMBER	FITS SWITCH MODEL	OPTION(S) REQUIRED	INCLUDES	
			DRESS NUT	CAP
A1354P1	810/820	KM	A495P1	B494P1
A1354P2	401/402	S	A495P1	B494P2
A1354P3	PB	PY	A495P1	B494P3
A1355P1	810/820	KM	A495P2	B494P1
A1355P2	302	NONE	A495P2	B494P2
A1355P2	401/402	NONE	A495P2	B494P2
A1355P3	PB	PY or P2Y1	A495P2	B494P3



Order Assembly Number from chart to left. Add cap color no. from color code chart below. Example: A1354P36 indicates assembly to fit a PB switch and is supplied with a red cap.

SWITCH MODEL	OPTION (IF REQ'D)	A1354		A1355	
		A	P.T.	A	P.T.
810/820	KM	.040	.062	.090	.093
PB	PY	.100	.125	.135	.171
PB	P2Y1	-	-	.120	.093
302	-	-	-	.070	.078
401/402	-	-	-	.130	.078
401/402	S	.130	.062	-	-



'A' dimension is determined by panel thickness indicated in table and allows for (1) back-up Nut A112 and (1) Lockwasher A115. Order these separately to provide for secure, vibration resistant mounting.

PART NO.	A DIA.	B DIA.
A495P1	.385	.323
A495P2	.413	.245

SPECIFICATIONS SUBJECT TO CHANGE WITHOUT NOTICE



### COLOR CAP Vinyl plastisol



PART NO.	DIM. A	FITS ACTUATOR
A118	5/16	K
A391	3/16	L2
A392	3/4	L

### PUSHBUTTON CAPS (ALL)

Material - Nylon

Caps press fit adequately, however they may be pulled off. If permanent retention is required, cement with Loctite 405 or equivalent, insuring no cement enters switch.

### PUSHBUTTON CAP A212



FITS PB SERIES

### COLOR CAPS B366 & B497



**B366** fits 300 & 400 Series with S option only, and all PB Series.

**B497** fits 800 Series with options KM, KS, KM1, K1M1 & K2M1.

### PUSHBUTTON CAPS A180 & A496



**A180** fits all PB Series.

**A496** fits 800 Series with options KM, KS, KM1, K1M1, K2M, K2S & K2M1.

### PUSHBUTTON CAP A235



\* - fits all PB, 300 & 400 Series.

\*\* - fits 800 Series with options KM, KS, KM1 & K2M1.

### PUSHBUTTON CAP A420



\* - Fits all 300 Series except 301 & 305. Fits 301 & 305 with S option. Fits all 400 & PB Series.

\*\* - Fits 800 Series with options KM, KS, KM1 & K2M1.

### STANDARD COLOR CODE

For nylon caps, actuators, bezels & bezel inserts. To specify, add selected color code to part number. Example: A2122 is a black A212 Cap. To specify for actuators, bezels and bezel inserts, see 'Order Format' section following specific series information in this catalog.

Code	Color	Code	Color
1	blue	2	black
3	green	4	gray
5	yellow	6	red
7	ivory	8	white
9	orange		

# MISCELLANEOUS PUSHBUTTON ACCESSORIES & CAPS (CONT'D.)

## COLOR CAP B494

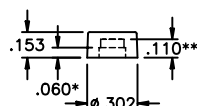

\*\* - P1 fits all 800 Series except K1M & K1S.

\* - P2 fits all 300 & 400 Series.

\* - P3 fits all PB Series.

## PUSHBUTTON CAP A631

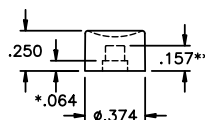

\* - Fits all 300 Series except 301 & 305. Fits 301 & 305 with S option. Fits all 400 & PB Series.

\*\* - Fits 800 Series with options KM, KS, KM1 & K2M1.

## PUSHBUTTON CAP A632

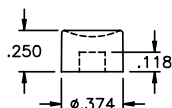

Fits all PB Series.

## CUSTOM MARKING

Permanent ink marking is available for switch caps, bezels and rocker actuators. Consult factory with your special requirement. Representative samples available.

## SWITCH GUARDS

Materials: 5056-H18 aluminum with clear or black anodize, or free machining brass with bright chrome plate. Dimensions in inches and (millimeters). Tolerances: A & D,  $\pm .015$ " B & C,  $\pm .005$ "

MODEL	TH'D.	COLOR	FINISH	A	B	C	D
MG11A	10-48	NATURAL AL.	PLAIN				
MG11B	10-48	BLACK AL.	PLAIN				
MG12A	1/4-40	NATURAL AL.	PLAIN				
MG12B	1/4-40	BLACK AL.	PLAIN	.530 (13.5)	.413 (10.5)	.315 (8.0)	.236 (6.0)
MG12C	1/4-40	CHROMED BR.	PLAIN				
MG12KA	1/4-40	NATURAL AL.	KNURLED				
MG12KB	1/4-40	BLACK AL.	KNURLED				
MG12KC	1/4-40	CHROMED BR.	KNURLED				
MG13A	1/4-40	NATURAL AL.	PLAIN				
MG13B	1/4-40	BLACK AL.	PLAIN	.730 (18.5)	.610 (15.5)	.315 (8.0)	.236 (6.0)
MG13C	1/4-40	CHROMED BR.	PLAIN				

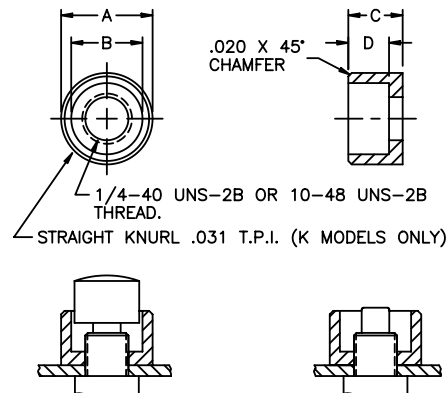

## STANDARD COLOR CODE

For nylon caps, actuators, bezels & bezel inserts. To specify, add selected color code to part number. Example: A2122 is a black A212 Cap. To specify for actuators, bezels and bezel inserts, see 'Order Format' section following specific series information in this catalog.

Code	Color	Code	Color
1	blue	2	black
3	green	4	gray
5	yellow	6	red
7	ivory	8	white
9	orange		

## CAPS FOR PRINTED CIRCUIT BOARD PROCESSING

Available on models with plain bushing. Supplied mounted on switches or separately. Provides additional protection during pcb processing.

Outline	Series	Material	Part No.
	S	Vinyl	U3012
	TP	Vinyl	U3502

SPECIFICATIONS SUBJECT TO CHANGE WITHOUT NOTICE

D

# SECURITY GUARDS for switch series 12000, 3500, 600H and 6000

## FEATURES

- Security guards prevent inadvertent switch operation.
- When guard cap is raised, switch actuator operates freely.
- When guard cap is depressed, switch actuator is locked in set position.
- Designed for use on switches with 11.9mm (.468") or 12mm (.472") dia. threaded bushings and actuator length 17.5mm (.688") outside bushing .
- Adjust guard for correct switch operation with 2 nuts.



## MATERIALS

Support plate: Matte black steel  
 Cap: Thermoset plastic

### Series 20 - for 2 position switches

Actuator returned then locked in down position (OFF)

MODEL NO.	COLOR
22	Gray
23	White
24	Orange
25	Black
26	Red
27	Green
28	Yellow
25/28	Black/yellow striped



### Series 30 - for 3 position switches

Actuator returned then locked in upper position

MODEL NO.	COLOR
32	Gray
33	White
34	Orange
35	Black
36	Red
37	Green
38	Yellow
39	Yellow
35/38	Black/yellow striped



### Series 40 - for 2 position switches

Actuator returned then locked in upper position

MODEL NO.	COLOR
42	Gray
43	White
44	Orange
45	Black
46	Red
47	Green
48	Yellow
49	Blue
45/48	Black/yellow striped



SPECIFICATIONS SUBJECT TO CHANGE WITHOUT NOTICE

D

# SECURITY GUARDS for switch series 12000, 3500, 600H and 6000

## Series 50 - for 2 position switches

Actuator returned then locked in down position (OFF)

MODEL NO.	COLOR
52	Gray
53	White
54	Orange
55	Black
56	Red
57	Green
58	Yellow
59	Blue
55/58	Black/yellow striped



## Series 60 - for 3 position switches

Actuator returned then locked in upper position

MODEL NO.	COLOR
62	Gray
63	White
64	Orange
65	Black
66	Red
67	Green
68	Yellow
69	Blue
65/68	Black/yellow striped



## Series 70 - for 2 position switches

Actuator returned then locked in upper position

MODEL NO.	COLOR
72	Gray
73	White
74	Orange
75	Black
76	Red
77	Green
78	Yellow
79	Yellow
75/78	Black/yellow striped



## Series 20PN - for 2 position switches

Actuator returned then locked in down position (OFF)  
Option P - holes for wiring seal standard on this model

MODEL NO.	COLOR
22PN	Gray
23PN	White
24PN	Orange
25PN	Black
26PN	Red
27PN	Green
28PN	Yellow
29PN	Blue



SPECIFICATIONS SUBJECT TO CHANGE WITHOUT NOTICE

D



# SECURITY GUARDS for switch series 12000, 3500, 600H and 6000

## PANEL CUT-OUTS & OPTIONS



**P** Holes for wiring seal

Cap engraving available - consult factory.

Other locking configurations such as locked center position available - consult factory.

## SECURITY GUARDS for switch series 3500, 600H and 6000

### Series 90

Actuator locked in center position



### Bushing shapes - for standard products

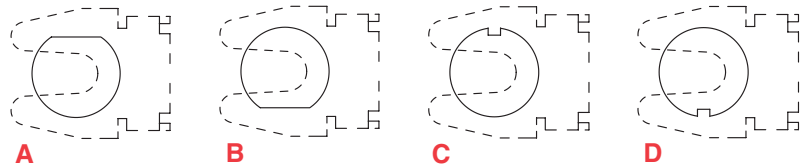

### - for other products

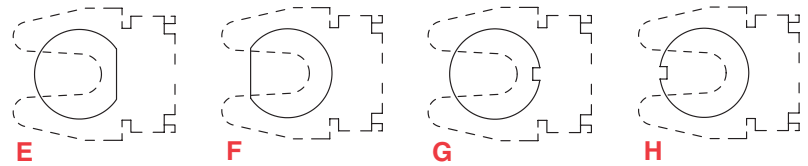

### Security guard cap shape

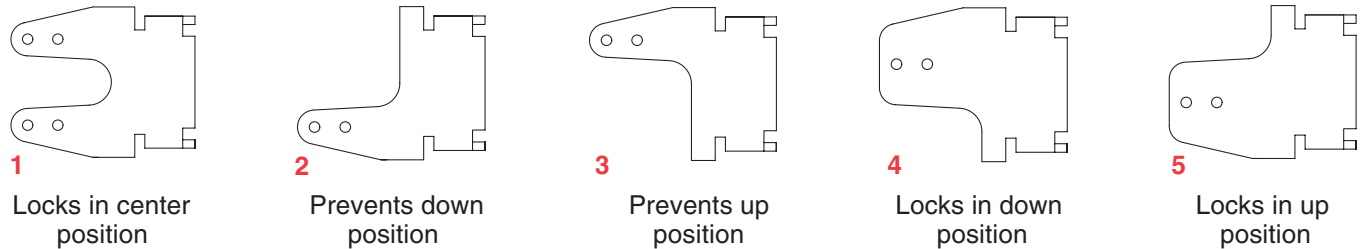

### Security guard cap colors

OPTION	COLOR
1	Blue
2	Black
3	Green
4	Gray
5	Yellow
6	Red
7/1	White
9	Orange
0	Striped (see color of stripes)

### Color of stripes

OPTION	STRIPE 1	STRIPE 2
A	Red	Black
B	Yellow	Black
C	Red	White
D	White	Black

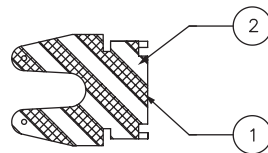

### How to order

Series Bushing shape Cap shape Cap color Color of stripes



Fill in boxes by making selections from each category indicated.

Example of completely specified model number:

**90A10B**

SPECIFICATIONS SUBJECT TO CHANGE WITHOUT NOTICE

**D**

# SEALING BOOTS FOR SWITCHES

## FEATURES

- Prevents dust, sand and water from entering switches.
- Prevents ice from blocking actuator movement on toggle switches.
- Compatible with internally sealed toggle and pushbutton actuators.
- Available in a wide range of colors .
- Each boot is supplied with a sealing ring or washer.

## MATERIALS AND SPECIFICATIONS

**Boot material:** Neoprene or silicone (see comparative advantages below)  
**Nut material:** Nickel plated or matte black finished brass  
**Operating temperature:** Neoprene; -20°C to 50°C    -40°C to 85°C

Comparative Advantages	Temperature Range		Elasticity	Mechanical Resistance
	Low	High		
Silicone	Excellent	Excellent	Excellent	Poor
Neoprene	Poor	Good	Poor	Excellent

## TYPES OF BOOTS - CROSS SECTIONS

\* Color options available



## EXAMPLES OF MOUNTING



## For toggle bushing 6 x 0.75 (.236 x 0.75) - 5500 series



NUT	FULL TOGGLE SILICONE BOOTS			
	Black	Red	Green	White
<b>Knurled</b> Nickel plated	U1341	U1341-6	U1341-3	U1341-7
<b>Knurled</b> Matte black	U1343	U1343-6	U1343-3	U1343-7
<b>Hex</b> Nickel plated	U1302	U1302-6	U1302-3	U1302-7
<b>Hex</b> Matte black	U1304	U1304-6	U1304-3	U1304-7



# SEALING BOOTS FOR SWITCHES

## For toggle bushing 6,35-40NS (1/4-40NS) - 5000 and 11000 series



NUT	FULL TOGGLE SILICONE BOOTS			
	Black	Red	Green	White
<b>Knurled</b> Nickel plated	U1331	U1331-6	U1331-3	U1331-7
<b>Knurled</b> Matte black	U1333	U1333-6	U1333-3	U1333-7
<b>Hex</b> Nickel plated	U1229	U1229-6	U1229-3	U1229-7
<b>Hex</b> Matte black	U1231	U1231-6	U1231-3	U1231-7



## For toggle bushing 6,35-40NS (1/4-40NS) - 5000 and 11000 series



NUT	SILICONE BOOTS (supplied as 2 separate parts)			
	Black	Red	Green	White
	U5149	U5149-6	U5149-3	U5149-7

When boot is mounted onto panel, metal parts of switch are completely covered by insulation.



## For toggle bushing 10 x 0.75 (.393 x 0.75) - 10600 series



KNURLED NUT	FULL TOGGLE SILICONE BOOTS			
	Black	Red	Green	White
Nickel plated	U1612	U1612-6	U1612-3	U1612-7
Matte black	U1614	U1614-6	U1614-3	U1614-7



## For toggle bushing 11,9-32 (15/32-32NS) - 12000, 3500 and 6000 series



HEX NUT	FULL TOGGLE SILICONE BOOTS			
	Black	Red	Green	White
Nickel plated	U1031	U1031-6	U1031-3	U1031-7
Matte black	U1024	U1024-6	U1024-3	U1024-7



SPECIFICATIONS SUBJECT TO CHANGE WITHOUT NOTICE

D

# SEALING BOOTS FOR SWITCHES

For toggle bushing 11,9-32NS (15/32-32NS) - 12000, 3500 and 6000 series



HEX NUT	HALF TOGGLE SILICONE BOOTS			
	Black	Red	Green	White
Nickel plated	U1600	U1600-6	U1600-3	U1600-7
Matte black	U1602	U1602-6	U1602-3	U1602-7



D

For toggle bushing 12 X 0.75 SI (.472 X 0.75 IS) - 4450, 4650 and 1600 series



HEX NUT	FULL TOGGLE BLACK NEOPRENE BOOTS
Nickel plated	U09
Matte black	U223



For toggle bushing 12 x 0.75 SI (.472 x 0.75 IS) - 400, 500, 600H, 6-600H, 600SH, 660, 1000, 1500 and 3600 series



HEX NUT	FULL TOGGLE SILICONE BOOTS			
	Black	Red	Green	White
Nickel plated	U1565	U1565-6	U1565-3	U1565-7
Matte black	U1567	U1567-6	U1567-3	U1567-7
	FULL TOGGLE BLACK NEOPRENE BOOTS			
Nickel plated	U851			
Matte black	U853			



For toggle bushing 12 x 0.75 SI (.472 x 0.75 IS) - 400, 500, 600H, 6-600H, 660, 1000 and 3600 series



HEX NUT	HALF TOGGLE SILICONE BOOTS			
	Black	Red	Green	White
Nickel plated	U1151	U1151-6	U1151-3	U1151-7
Matte black	U1153	U1153-6	U1153-3	U1153-7
	HALF TOGGLE BLACK NEOPRENE BOOTS			
Nickel plated	U598			
Matte black	U600			



SPECIFICATIONS SUBJECT TO CHANGE WITHOUT NOTICE

# SEALING BOOTS FOR SWITCHES

For pushbutton bushing 4 x 0.70 (.157 x 0.70) - 9500 series



HEX NUT	PUSHBUTTON SILICONE BOOTS			
	Black	Red	Green	White
Nickel plated	U1829	U1829-6	U1829-3	U1829-7
Matte black	U1831	U1831-6	U1831-3	U1831-7



For pushbutton bushing 6,35-40NS (1/4-40NS) - 18000, 9000 and 13000 series



NUT	PUSHBUTTON SILICONE BOOTS			
	Black	Red	Green	White
<b>Knurled</b> Nickel plated	U1401	U1401-6	U1401-3	U1401-7
<b>Knurled</b> Matte black	U1403	U1403-6	U1403-3	U1403-7
<b>Hex</b> Nickel plated	U1318	U1318-6	U1318-3	U1318-7
<b>Hex</b> Matte black	U1320	U1320-6	U1320-3	U1320-7



For pushbutton bushing 10 x 0.75 (.393 x 0.75) - 10400 series



KNURLED NUT	PUSHBUTTON SILICONE BOOTS			
	Black	Red	Green	White
Nickel plated	U1624	U1624-6	U1624-3	U1624-7
Matte black	U1626	U1626-6	U1626-3	U1626-7



For pushbutton bushing 11,9-32NS (15/32-32NS) - 13000X778 and 13000X768 series



HEX NUT	PUSHBUTTON SILICONE BOOTS			
	Black	Red	Green	White
Nickel plated	U589	U589-6	U589-3	U589-7
Matte black	U590	U590-6	U590-3	U590-7



SPECIFICATIONS SUBJECT TO CHANGE WITHOUT NOTICE

D

# SEALING BOOTS FOR SWITCHES

For pushbutton bushing 12 x 0.75 SI (.472 x 0.75) - 1200, 4700 and 4800 series



HEX NUT	PUSHBUTTON SILICONE BOOTS			
	Black	Red	Green	White
Nickel plated	U1654	U1654-6	U1654-3	U1654-7
Matte black	U1656	U1656-6	U1656-3	U1656-7
	PUSHBUTTON BLACK NEOPRENE BOOTS			
Nickel plated	U31			
Matte black	U225			
Chrome plated	U224			



D

For double sealing IP series



**TRANSPARENT SILICONE BOOT**  
U5125



For external sealing on A02 series

**SILICONE BOOT**  
A02WPC



For 2600 series rocker switches



**TRANSPARENT SILICONE BOOT**  
U2150



SPECIFICATIONS SUBJECT TO CHANGE WITHOUT NOTICE

# VL SERIES LED INDICATORS

## FEATURES

- Indicators with red, yellow or green built-in LED.
- Flatted bushing for anti-rotation.
- 2 bushing diameters: 6mm (.236") and 8mm (.314").
- Sealed and unsealed models.
- Bright chrome or matte black plated finishes.

## SPECIFICATIONS

Insulation resistance:	1000 megohms min.
Dielectric strength:	250 Vrms, 50 Hz min.
Electric life at high temperature:	72 hours at 85°C
Torque:	1.25 Nm (.922 ft.lb.) max.applied to nut
Climatic category:	40/085/21
Protection level (sealed models):	IP67 per IEC 529
In accordance with NFC 93680 standard	

## LED SPECIFICATIONS

(T ambient = 25°C)

Forward voltage:	2VDC ( $\leq 2.6V$ )
Nominal current:	10mA
Max. surge current:	0.5 A (tp<10 $\mu$ s)
Max. reversed voltage:	25V
Max. forward current:	40mA
Max. power dissipation:	100mW

## MATERIALS

<b>Bushing and collar:</b>	Brass, bright or matte black chrome plated
<b>Lens:</b>	Polycarbonate
<b>Hardware supplied:</b>	1 nickel plated brass hex nut; 9mm (.354") across flats for 6mm (.236") dia. indicator or 10mm (.393") across flats for 8mm (.314") dia. indicator.

SPECIFICATIONS SUBJECT TO CHANGE WITHOUT NOTICE

D

### 6mm (.236") diameter - unsealed



LED COLOR	BRIGHT FINISH	MATTE BLACK FINISH
Red	VL1000P600	VL100GP600
Yellow	VL1000P500	VL100GP500
Green	VL1000P300	VL100GP300

Note: Bright finish is standard.

Arrow indicates bushing flat. Option: bushing without flat and lockwasher- on request



### 8mm (.314") diameter - unsealed



LED COLOR	BRIGHT FINISH	MATTE BLACK FINISH
Red	VL3000P600	VL300GP600
Yellow	VL3000P500	VL300GP500
Green	VL3000P300	VL300GP300

Note: Bright finish is standard.

Arrow indicates bushing flat. Option: bushing without flat and lockwasher- on request



# VL SERIES LED INDICATORS

## 6mm (.236") diameter - sealed



LED COLOR	BRIGHT FINISH	MATTE BLACK FINISH
Red	VL1CK0P600	VL1CKGP600
Yellow	VL1CK0P500	VL1CKGP500
Green	VL1CK0P300	VL1CKGP300

Notes: Bright finish is standard. Lens cap is the same color as the LED.

Arrow indicates bushing flat. Option: bushing without flat and lockwasher- on request



D

## 8mm (.314") diameter - sealed



LED COLOR	BRIGHT FINISH	MATTE BLACK FINISH
Red	VL3CK0P600	VL3CKGP600
Yellow	VL3CK0P500	VL3CKGP500
Green	VL3CK0P300	VL3CKGP300

Note: Bright finish is standard. Lens cap is the same color as the LED.

Arrow indicates bushing flat. Option: bushing without flat and lockwasher- on request



## LED'S

Observe polarity of DC supply to LED's. Longer lead is anode (+). Shorter lead is cathode (-) on flat side of bushing (see drawing).

LED's are not removable.

LED's per customer specifications that meet drawings shown can be supplied - consult factory.



For 6mm (.236") indicators



For 8mm (.314") indicators

## STANDARD HARDWARE AND PANEL CUT-OUTS



For 6mm (.236") indicators

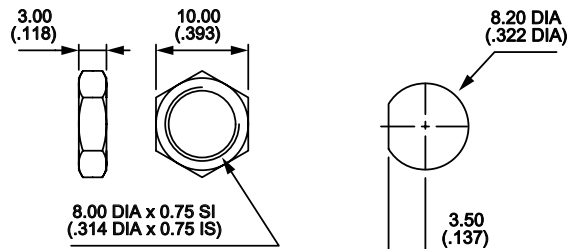

For 8mm (.314") indicators

SPECIFICATIONS SUBJECT TO CHANGE WITHOUT NOTICE





Компания «ЭлектроПласт» предлагает заключение долгосрочных отношений при поставках импортных электронных компонентов на взаимовыгодных условиях!

Наши преимущества:

- Оперативные поставки широкого спектра электронных компонентов отечественного и импортного производства напрямую от производителей и с крупнейших мировых складов;
- Поставка более 17-ти миллионов наименований электронных компонентов;
- Поставка сложных, дефицитных, либо снятых с производства позиций;
- Оперативные сроки поставки под заказ (от 5 рабочих дней);
- Экспресс доставка в любую точку России;
- Техническая поддержка проекта, помощь в подборе аналогов, поставка прототипов;
- Система менеджмента качества сертифицирована по Международному стандарту ISO 9001;
- Лицензия ФСБ на осуществление работ с использованием сведений, составляющих государственную тайну;
- Поставка специализированных компонентов (Xilinx, Altera, Analog Devices, Intersil, Interpoint, Microsemi, Aeroflex, Peregrine, Syfer, Eurofarad, Texas Instrument, Miteq, Cobham, E2V, MA-COM, Hittite, Mini-Circuits, General Dynamics и др.);

Помимо этого, одним из направлений компании «ЭлектроПласт» является направление «Источники питания». Мы предлагаем Вам помощь Конструкторского отдела:

- Подбор оптимального решения, техническое обоснование при выборе компонента;
- Подбор аналогов;
- Консультации по применению компонента;
- Поставка образцов и прототипов;
- Техническая поддержка проекта;
- Защита от снятия компонента с производства.



#### Как с нами связаться

**Телефон:** 8 (812) 309 58 32 (многоканальный)

**Факс:** 8 (812) 320-02-42

**Электронная почта:** [org@eplast1.ru](mailto:org@eplast1.ru)

**Адрес:** 198099, г. Санкт-Петербург, ул. Калинина, дом 2, корпус 4, литера А.