

MISCELLANEOUS HARDWARE & ACCESSORIES

SPECIFICATIONS SUBJECT TO CHANGE WITHOUT NOTICE

SWITCH HARDWARE.....	D2 - D4
PUSHBUTTON AND TOGGLE CAPS.....	D5 - D6
SECURITY GUARDS.....	D7 - D9
SEALING BOOTS.....	D10 - D14
VL SERIES LED INDICATORS.....	D15 - D16



MISCELLANEOUS HARDWARE

HEX NUT A112 Nickel plated brass
1/4-40



HEX NUT Brass 1/4-40
Nickel plated **U76** Matte black **U94**



HEX NUT Brass
Nickel plated **U208** Matte black **U726**



HEX NUT Brass
Chrome plated **U1916**



HEX NUT U842 10mm (.393")
Nickel plated brass



HEX NUT A465
Nickel plated brass 15/32-32



HEX NUT Brass 15/32-32
Nickel plated **U162** Matte black **U41**
Chrome plated **U92**



HEX NUT Brass 12mm (.472")
Nickel plated **U166** Matte black **U183**
Chrome plated **U212**



HEX CAP NUT Brass 12mm (.472")
Chrome plated **U35**



PAL NUT U42 12mm (.472")
Zinc plated steel



HEX NUT 10-621 16mm (.629")
Nickel plated brass

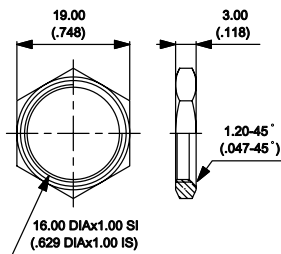

HEX NUT U1950-5 19mm (.748")
Nickel plated brass



HEX NUT 10-855-5 19mm (.748")
Nickel plated brass



HEX NUT U1951-5 22mm (.866")
Nickel plated brass



HEX NUT 10-856-5 22mm (.866")
Nickel plated brass



HEX NUT U2059-5 24mm (.944")
Nickel plated brass



PANEL DRESS NUT A168P1
Blind thread, Nickel plated brass
1/4-40



PANEL DRESS NUT A168P2
Thru thread, Nickel plated brass
1/4-40



PANEL DRESS NUT A274
Nickel plated brass 1/4-40



PANEL DRESS NUT A540
Nickel plated brass 15/32-32



SPECIFICATIONS SUBJECT TO CHANGE WITHOUT NOTICE

D

MISCELLANEOUS HARDWARE (CONT'D.)

SPECIFICATIONS SUBJECT TO CHANGE WITHOUT NOTICE

D

<p>DECORATIVE NUT A447 Thru thread, chromium plated brass 1/4-40</p> 	<p>KNURLED NUT U369 1/4-40 Nickel plated brass</p> 	<p>KNURLED NUT U501 1/4-40 Chrome plated brass</p> 	<p>KNURLED NUT Brass 1/4-40 Nickel plated U229 Matte black U230</p> 
<p>KNURLED NUT U826 Nickel plated brass</p> 	<p>KNURLED CAP NUT Brass 1/4-40 Chrome plated U216 Matte black U218</p> 	<p>KNURLED CAP NUT Brass Chrome pl. U461 Matte black U502</p> 	<p>KNURLED CAP NUT Brass Chrome plated U232</p> 
<p>KNURLED CAP NUT Brass 1/4-40 Chrome pl. U268 Matte black U725</p> 	<p>KNURLED NUT U2311 10mm (.393") Chrome plated brass</p> 	<p>KNURLED CAP NUT U2220 10mm (.393") Chrome plated brass</p> 	<p>KNURLED NUT Brass 15/32-32 Nickel plated U53 Matte black U1634</p> 
<p>KNURLED CAP NUT U123 15/32-32 Chrome plated brass</p> 	<p>KNURLED CAP NUT U124 15/32-32 Chrome plated brass</p> 	<p>PANEL DRESS NUT Brass 12mm (.472") Nickel plated U411, Matte black U413, Chrome plated U412</p> 	<p>KNURLED CAP NUT Brass 12mm (.472") Chrome plated U117 Matte black U129</p> 
<p>KNURLED CAP NUT Brass 12mm (.472") Chrome plated U118 Matte black U130</p> 	<p>INSULATED PANEL DRESS NUT 12mm (.472") ABS or polyamide with glass fiber. blue U521, black U522, green U523, gray U524, yellow U525, red U526, white U527/1, orange U529</p> 	<p>KNURLED NUT 10-960-5 16mm (.629") Nickel plated brass</p> 	<p>KNURLED NUT U1977-5 19mm (.748") Nickel plated brass</p> 

MISCELLANEOUS HARDWARE (CONT'D.)

<p>LOCKWASHER U14 .122 I.D. Stainless steel</p> 	<p>LOCKWASHER 1/4 Stainless steel U215</p> 	<p>LOCKWASHER A115 Nickel plated steel 1/4</p> 	<p>LOCKWASHER U843 10mm (.393") Stainless steel</p> 
<p>LOCKWASHER A466 Nickel plated steel 15/32</p> 	<p>LOCKWASHER U13 15/32 Zinc plated</p> 	<p>ANTI-ROTATE RING A107 Nickel plated brass 1/4</p> 	<p>LOCKING RING 1/4 Nickel plated U78 Matte black U93</p> 
<p>LOCKING RING Brass Nickel plated U198 Matte black U728</p> 	<p>ANTI-ROTATE RING (LARGE) A158 Nickel plated brass 1/4</p> 	<p>LOCKING RING U844 10mm (.393") Nickel plated</p> 	<p>ANTI-ROTATE RING A482 Nickel plated brass 15/32</p> 
<p>LOCKING RING 12mm (.472") Nickel plated U121 Matte black U12</p> 	<p>SEALING WASHER U360 1/4-40 For keyway bushing</p> 	<p>SEALING WASHER U60 15/32</p> 	<p>SEALING WASHER Nylon 12mm (.472") U21</p> 
<p>GROUND CONNECTOR 12mm (.472") Nickel plated U187</p> 	<p>SWITCH PLATE I-O U1050 .480 I.D.</p> 	<p>SWITCH PLATE ON-OFF U19 .480 I.D.</p> 	<p>CONNECTING SCREW U03</p> 

SPECIFICATIONS SUBJECT TO CHANGE WITHOUT NOTICE

D

MISCELLANEOUS PUSHBUTTON ACCESSORIES & CAPS

Note: additional caps are shown in some switch sections.

PANEL DRESS NUTS & CAPS FOR PUSHBUTTON SWITCHES

ASSEMBLY NUMBER	FITS SWITCH MODEL	OPTION(S) REQUIRED	INCLUDES	
			DRESS NUT	CAP
A1354P1	810/820	KM	A495P1	B494P1
A1354P2	401/402	S	A495P1	B494P2
A1354P3	PB	PY	A495P1	B494P3
A1355P1	810/820	KM	A495P2	B494P1
A1355P2	302	NONE	A495P2	B494P2
A1355P2	401/402	NONE	A495P2	B494P2
A1355P3	PB	PY or P2Y1	A495P2	B494P3



Order Assembly Number from chart to left. Add cap color no. from color code chart below. Example: A1354P36 indicates assembly to fit a PB switch and is supplied with a red cap.

SWITCH MODEL	OPTION (IF REQ'D)	A1354		A1355	
		A	P.T.	A	P.T.
810/820	KM	.040	.062	.090	.093
PB	PY	.100	.125	.135	.171
PB	P2Y1	-	-	.120	.093
302	-	-	-	.070	.078
401/402	-	-	-	.130	.078
401/402	S	.130	.062	-	-



'A' dimension is determined by panel thickness indicated in table and allows for (1) back-up Nut A112 and (1) Lockwasher A115. Order these separately to provide for secure, vibration resistant mounting.

PART NO.	A DIA.	B DIA.
A495P1	.385	.323
A495P2	.413	.245

SPECIFICATIONS SUBJECT TO CHANGE WITHOUT NOTICE



COLOR CAP Vinyl plastisol



PART NO.	DIM. A	FITS ACTUATOR
A118	5/16	K
A391	3/16	L2
A392	3/4	L

PUSHBUTTON CAPS (ALL)

Material - Nylon

Caps press fit adequately, however they may be pulled off. If permanent retention is required, cement with Loctite 405 or equivalent, insuring no cement enters switch.

PUSHBUTTON CAP A212



FITS PB SERIES

COLOR CAPS B366 & B497



B366 fits 300 & 400 Series with S option only, and all PB Series.

B497 fits 800 Series with options KM, KS, KM1, K1M1 & K2M1.

PUSHBUTTON CAPS A180 & A496



A180 fits all PB Series.

A496 fits 800 Series with options KM, KS, KM1, K1M1, K2M, K2S & K2M1.

PUSHBUTTON CAP A235



* - fits all PB, 300 & 400 Series.

** - fits 800 Series with options KM, KS, KM1 & K2M1.

PUSHBUTTON CAP A420



* - Fits all 300 Series except 301 & 305. Fits 301 & 305 with S option. Fits all 400 & PB Series.

** - Fits 800 Series with options KM, KS, KM1 & K2M1.

STANDARD COLOR CODE

For nylon caps, actuators, bezels & bezel inserts. To specify, add selected color code to part number. Example: A2122 is a black A212 Cap. To specify for actuators, bezels and bezel inserts, see 'Order Format' section following specific series information in this catalog.

Code	Color	Code	Color
1	blue	2	black
3	green	4	gray
5	yellow	6	red
7	ivory	8	white
9	orange		

MISCELLANEOUS PUSHBUTTON ACCESSORIES & CAPS (CONT'D.)

COLOR CAP B494



** - P1 fits all 800 Series except K1M & K1S.
 * - P2 fits all 300 & 400 Series.
 * - P3 fits all PB Series.

PUSHBUTTON CAP A631



* - Fits all 300 Series except 301 & 305. Fits 301 & 305 with S option. Fits all 400 & PB Series.
 ** - Fits 800 Series with options KM, KS, KM1 & K2M1.

PUSHBUTTON CAP A632



Fits all PB Series.

CUSTOM MARKING

Permanent ink marking is available for switch caps, bezels and rocker actuators. Consult factory with your special requirement. Representative samples available.

SWITCH GUARDS

Materials: 5056-H18 aluminum with clear or black anodize, or free machining brass with bright chrome plate.
 Dimensions in inches and (millimeters). Tolerances: A & D, $\pm .015"$ B & C, $\pm .005"$

MODEL	TH'D.	COLOR	FINISH	A	B	C	D
MG11A	10-48	NATURAL AL.	PLAIN				
MG11B	10-48	BLACK AL.	PLAIN				
MG12A	1/4-40	NATURAL AL.	PLAIN				
MG12B	1/4-40	BLACK AL.	PLAIN	.530 (13.5)	.413 (10.5)	.315 (8.0)	.236 (6.0)
MG12C	1/4-40	CHROMED BR.	PLAIN				
MG12KA	1/4-40	NATURAL AL.	KNURLED				
MG12KB	1/4-40	BLACK AL.	KNURLED				
MG12KC	1/4-40	CHROMED BR.	KNURLED				
MG13A	1/4-40	NATURAL AL.	PLAIN				
MG13B	1/4-40	BLACK AL.	PLAIN	.730 (18.5)	.610 (15.5)	.315 (8.0)	.236 (6.0)
MG13C	1/4-40	CHROMED BR.	PLAIN				



STANDARD COLOR CODE

For nylon caps, actuators, bezels & bezel inserts.
 To specify, add selected color code to part number. Example: A2122 is a black A212 Cap. To specify for actuators, bezels and bezel inserts, see 'Order Format' section following specific series information in this catalog.

Code	Color	Code	Color
1	blue	2	black
3	green	4	gray
5	yellow	6	red
7	ivory	8	white
9	orange		

CAPS FOR PRINTED CIRCUIT BOARD PROCESSING

Available on models with plain bushing.
 Supplied mounted on switches or separately.
 Provides additional protection during pcb processing.

Outline	Series	Material	Part No.
	S	Vinyl	U3012
	TP	Vinyl	U3502

SPECIFICATIONS SUBJECT TO CHANGE WITHOUT NOTICE

D

SECURITY GUARDS for switch series 12000, 3500, 600H and 6000

FEATURES

- Security guards prevent inadvertent switch operation.
- When guard cap is raised, switch actuator operates freely.
- When guard cap is depressed, switch actuator is locked in set position.
- Designed for use on switches with 11.9mm (.468") or 12mm (.472") dia. threaded bushings and actuator length 17.5mm (.688") outside bushing .
- Adjust guard for correct switch operation with 2 nuts.



MATERIALS

Support plate: Matte black steel
Cap: Thermoset plastic

Series 20 - for 2 position switches

Actuator returned then locked in down position (OFF)

MODEL NO.	COLOR
22	Gray
23	White
24	Orange
25	Black
26	Red
27	Green
28	Yellow
25/28	Black/yellow striped



Series 30 - for 3 position switches

Actuator returned then locked in upper position

MODEL NO.	COLOR
32	Gray
33	White
34	Orange
35	Black
36	Red
37	Green
38	Yellow
39	Yellow
35/38	Black/yellow striped



Series 40 - for 2 position switches

Actuator returned then locked in upper position

MODEL NO.	COLOR
42	Gray
43	White
44	Orange
45	Black
46	Red
47	Green
48	Yellow
49	Blue
45/48	Black/yellow striped



SPECIFICATIONS SUBJECT TO CHANGE WITHOUT NOTICE

D

SECURITY GUARDS for switch series 12000, 3500, 600H and 6000

Series 50 - for 2 position switches

Actuator returned then locked in down position (OFF)

MODEL NO.	COLOR
52	Gray
53	White
54	Orange
55	Black
56	Red
57	Green
58	Yellow
59	Blue
55/58	Black/yellow striped



Series 60 - for 3 position switches

Actuator returned then locked in upper position

MODEL NO.	COLOR
62	Gray
63	White
64	Orange
65	Black
66	Red
67	Green
68	Yellow
69	Blue
65/68	Black/yellow striped



Series 70 - for 2 position switches

Actuator returned then locked in upper position

MODEL NO.	COLOR
72	Gray
73	White
74	Orange
75	Black
76	Red
77	Green
78	Yellow
79	Yellow
75/78	Black/yellow striped



Series 20PN - for 2 position switches

Actuator returned then locked in down position (OFF)
Option P - holes for wiring seal standard on this model

MODEL NO.	COLOR
22PN	Gray
23PN	White
24PN	Orange
25PN	Black
26PN	Red
27PN	Green
28PN	Yellow
29PN	Blue



D

SPECIFICATIONS SUBJECT TO CHANGE WITHOUT NOTICE

SECURITY GUARDS for switch series 12000, 3500, 600H and 6000

PANEL CUT-OUTS & OPTIONS



P Holes for wiring seal

Cap engraving available - consult factory.
Other locking configurations such as locked center position available - consult factory.

SECURITY GUARDS for switch series 3500, 600H and 6000

Series 90

Actuator locked in center position

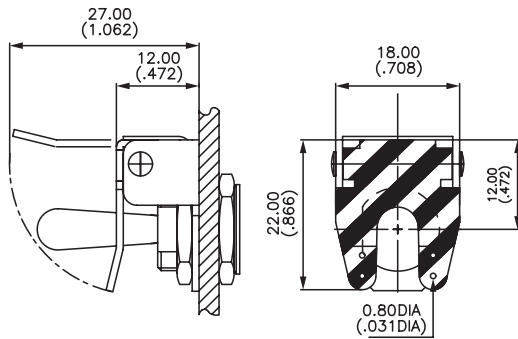

Bushing shapes - for standard products

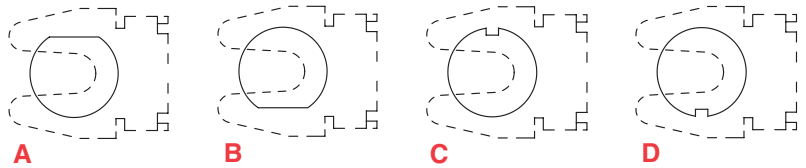

- for other products

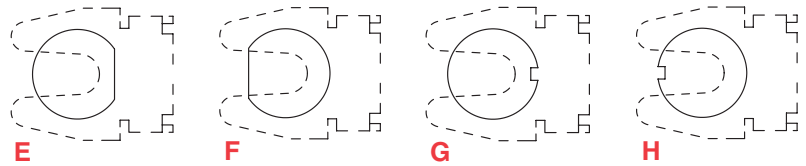

Security guard cap shape

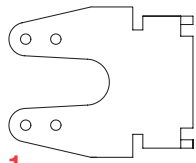

1
Locks in center position

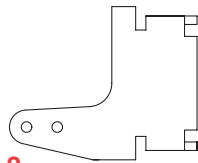

2
Prevents down position

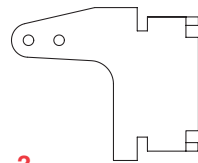

3
Prevents up position

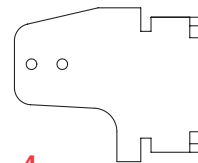

4
Locks in down position

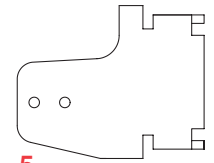

5
Locks in up position

Security guard cap colors

OPTION	COLOR
1	Blue
2	Black
3	Green
4	Gray
5	Yellow
6	Red
7/1	White
9	Orange
0	Striped (see color of stripes)

Color of stripes

OPTION	STRIPE 1	STRIPE 2
A	Red	Black
B	Yellow	Black
C	Red	White
D	White	Black

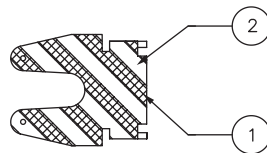

How to order

Series Bushing shape Cap shape Cap color Color of stripes



Fill in boxes by making selections from each category indicated.

Example of completely specified model number:

90A10B

SPECIFICATIONS SUBJECT TO CHANGE WITHOUT NOTICE

D

SEALING BOOTS FOR SWITCHES

FEATURES

- Prevents dust, sand and water from entering switches.
- Prevents ice from blocking actuator movement on toggle switches.
- Compatible with internally sealed toggle and pushbutton actuators.
- Available in a wide range of colors .
- Each boot is supplied with a sealing ring or washer.

MATERIALS AND SPECIFICATIONS

Boot material: Neoprene or silicone (see comparative advantages below)
Nut material: Nickel plated or matte black finished brass
Operating temperature: Neoprene; -20°C to 50°C -40°C to 85°C

Comparative Advantages	Temperature Range		Elasticity	Mechanical Resistance
	Low	High		
Silicone	Excellent	Excellent	Excellent	Poor
Neoprene	Poor	Good	Poor	Excellent

TYPES OF BOOTS - CROSS SECTIONS

* Color options available



EXAMPLES OF MOUNTING



For toggle bushing 6 x 0.75 (.236 x 0.75) - 5500 series



NUT	FULL TOGGLE SILICONE BOOTS			
	Black	Red	Green	White
Knurled Nickel plated	U1341	U1341-6	U1341-3	U1341-7
Knurled Matte black	U1343	U1343-6	U1343-3	U1343-7
Hex Nickel plated	U1302	U1302-6	U1302-3	U1302-7
Hex Matte black	U1304	U1304-6	U1304-3	U1304-7



SEALING BOOTS FOR SWITCHES

For toggle bushing 6,35-40NS (1/4-40NS) - 5000 and 11000 series



NUT	FULL TOGGLE SILICONE BOOTS			
	Black	Red	Green	White
Knurled Nickel plated	U1331	U1331-6	U1331-3	U1331-7
Knurled Matte black	U1333	U1333-6	U1333-3	U1333-7
Hex Nickel plated	U1229	U1229-6	U1229-3	U1229-7
Hex Matte black	U1231	U1231-6	U1231-3	U1231-7



For toggle bushing 6,35-40NS (1/4-40NS) - 5000 and 11000 series



NUT	SILICONE BOOTS (supplied as 2 separate parts)			
	Black	Red	Green	White
	U5149	U5149-6	U5149-3	U5149-7

When boot is mounted onto panel, metal parts of switch are completely covered by insulation.



For toggle bushing 10 x 0.75 (.393 x 0.75) - 10600 series



KNURLED NUT	FULL TOGGLE SILICONE BOOTS			
	Black	Red	Green	White
Nickel plated	U1612	U1612-6	U1612-3	U1612-7
Matte black	U1614	U1614-6	U1614-3	U1614-7



For toggle bushing 11,9-32 (15/32-32NS) - 12000, 3500 and 6000 series



HEX NUT	FULL TOGGLE SILICONE BOOTS			
	Black	Red	Green	White
Nickel plated	U1031	U1031-6	U1031-3	U1031-7
Matte black	U1024	U1024-6	U1024-3	U1024-7



SPECIFICATIONS SUBJECT TO CHANGE WITHOUT NOTICE

D

SEALING BOOTS FOR SWITCHES

For toggle bushing 11,9-32NS (15/32-32NS) - 12000, 3500 and 6000 series



HEX NUT	HALF TOGGLE SILICONE BOOTS			
	Black	Red	Green	White
Nickel plated	U1600	U1600-6	U1600-3	U1600-7
Matte black	U1602	U1602-6	U1602-3	U1602-7



D

For toggle bushing 12 X 0.75 SI (.472 X 0.75 IS) - 4450, 4650 and 1600 series



HEX NUT	FULL TOGGLE BLACK NEOPRENE BOOTS
Nickel plated	U09
Matte black	U223



For toggle bushing 12 x 0.75 SI (.472 x 0.75 IS) - 400, 500, 600H, 6-600H, 600SH, 660, 1000, 1500 and 3600 series



HEX NUT	FULL TOGGLE SILICONE BOOTS			
	Black	Red	Green	White
Nickel plated	U1565	U1565-6	U1565-3	U1565-7
Matte black	U1567	U1567-6	U1567-3	U1567-7
FULL TOGGLE BLACK NEOPRENE BOOTS				
Nickel plated	U851			
Matte black	U853			



For toggle bushing 12 x 0.75 SI (.472 x 0.75 IS) - 400, 500, 600H, 6-600H, 660, 1000 and 3600 series



HEX NUT	HALF TOGGLE SILICONE BOOTS			
	Black	Red	Green	White
Nickel plated	U1151	U1151-6	U1151-3	U1151-7
Matte black	U1153	U1153-6	U1153-3	U1153-7
HALF TOGGLE BLACK NEOPRENE BOOTS				
Nickel plated	U598			
Matte black	U600			



SPECIFICATIONS SUBJECT TO CHANGE WITHOUT NOTICE

SEALING BOOTS FOR SWITCHES

For pushbutton bushing 4 x 0.70 (.157 x 0.70) - 9500 series



HEX NUT	PUSHBUTTON SILICONE BOOTS			
	Black	Red	Green	White
Nickel plated	U1829	U1829-6	U1829-3	U1829-7
Matte black	U1831	U1831-6	U1831-3	U1831-7



For pushbutton bushing 6,35-40NS (1/4-40NS) - 18000, 9000 and 13000 series



NUT	PUSHBUTTON SILICONE BOOTS			
	Black	Red	Green	White
Knurled Nickel plated	U1401	U1401-6	U1401-3	U1401-7
Knurled Matte black	U1403	U1403-6	U1403-3	U1403-7
Hex Nickel plated	U1318	U1318-6	U1318-3	U1318-7
Hex Matte black	U1320	U1320-6	U1320-3	U1320-7



For pushbutton bushing 10 x 0.75 (.393 x 0.75) - 10400 series



KNURLED NUT	PUSHBUTTON SILICONE BOOTS			
	Black	Red	Green	White
Nickel plated	U1624	U1624-6	U1624-3	U1624-7
Matte black	U1626	U1626-6	U1626-3	U1626-7



For pushbutton bushing 11,9-32NS (15/32-32NS) - 13000X778 and 13000X768 series



HEX NUT	PUSHBUTTON SILICONE BOOTS			
	Black	Red	Green	White
Nickel plated	U589	U589-6	U589-3	U589-7
Matte black	U590	U590-6	U590-3	U590-7



SPECIFICATIONS SUBJECT TO CHANGE WITHOUT NOTICE

D

SEALING BOOTS FOR SWITCHES

For pushbutton bushing 12 x 0.75 SI (.472 x 0.75) - 1200, 4700 and 4800 series



HEX NUT	PUSHBUTTON SILICONE BOOTS			
	Black	Red	Green	White
Nickel plated	U1654	U1654-6	U1654-3	U1654-7
Matte black	U1656	U1656-6	U1656-3	U1656-7
	PUSHBUTTON BLACK NEOPRENE BOOTS			
Nickel plated	U31			
Matte black	U225			
Chrome plated	U224			



D

For double sealing IP series



TRANSPARENT SILICONE BOOT
U5125



For external sealing on A02 series

SILICONE BOOT
A02WPC



For 2600 series rocker switches



TRANSPARENT SILICONE BOOT
U2150



SPECIFICATIONS SUBJECT TO CHANGE WITHOUT NOTICE

VL SERIES LED INDICATORS

FEATURES

- Indicators with red, yellow or green built-in LED.
- Flatted bushing for anti-rotation.
- 2 bushing diameters: 6mm (.236") and 8mm (.314").
- Sealed and unsealed models.
- Bright chrome or matte black plated finishes.

SPECIFICATIONS

Insulation resistance:	1000 megohms min.
Dielectric strength:	250 Vrms, 50 Hz min.
Electric life at high temperature:	72 hours at 85°C
Torque:	1.25 Nm (.922 ft.lb.) max.applied to nut
Climatic category:	40/085/21
Protection level (sealed models):	IP67 per IEC 529
In accordance with NFC 93680 standard	

LED SPECIFICATIONS

(T ambient = 25°C)

Forward voltage:	2VDC ($\leq 2.6V$)
Nominal current:	10mA
Max. surge current:	0.5 A ($t_p < 10\mu s$)
Max. reversed voltage:	25V
Max. forward current:	40mA
Max. power dissipation:	100mW

MATERIALS

Bushing and collar:	Brass, bright or matte black chrome plated
Lens:	Polycarbonate
Hardware supplied:	1 nickel plated brass hex nut; 9mm (.354") across flats for 6mm (.236") dia. indicator or 10mm (.393") across flats for 8mm (.314") dia. indicator.

SPECIFICATIONS SUBJECT TO CHANGE WITHOUT NOTICE

D

6mm (.236") diameter - unsealed



LED COLOR	BRIGHT FINISH	MATTE BLACK FINISH
Red	VL1000P600	VL100GP600
Yellow	VL1000P500	VL100GP500
Green	VL1000P300	VL100GP300

Note: Bright finish is standard.

Arrow indicates bushing flat. Option: bushing without flat and lockwasher- on request



8mm (.314") diameter - unsealed



LED COLOR	BRIGHT FINISH	MATTE BLACK FINISH
Red	VL3000P600	VL300GP600
Yellow	VL3000P500	VL300GP500
Green	VL3000P300	VL300GP300

Note: Bright finish is standard.

Arrow indicates bushing flat. Option: bushing without flat and lockwasher- on request



VL SERIES LED INDICATORS

6mm (.236") diameter - sealed



LED COLOR	BRIGHT FINISH	MATTE BLACK FINISH
Red	VL1CK0P600	VL1CKGP600
Yellow	VL1CK0P500	VL1CKGP500
Green	VL1CK0P300	VL1CKGP300

Notes: Bright finish is standard. Lens cap is the same color as the LED.

Arrow indicates bushing flat. Option: bushing without flat and lockwasher- on request



D

8mm (.314") diameter - sealed



LED COLOR	BRIGHT FINISH	MATTE BLACK FINISH
Red	VL3CK0P600	VL3CKGP600
Yellow	VL3CK0P500	VL3CKGP500
Green	VL3CK0P300	VL3CKGP300

Note: Bright finish is standard. Lens cap is the same color as the LED.

Arrow indicates bushing flat. Option: bushing without flat and lockwasher- on request



LED'S

Observe polarity of DC supply to LED's. Longer lead is anode (+). Shorter lead is cathode (-) on flat side of bushing (see drawing).

LED's are not removable.

LED's per customer specifications that meet drawings shown can be supplied - consult factory.



For 6mm (.236") indicators



For 8mm (.314") indicators

STANDARD HARDWARE AND PANEL CUT-OUTS



For 6mm (.236") indicators



For 8mm (.314") indicators

SPECIFICATIONS SUBJECT TO CHANGE WITHOUT NOTICE



Компания «ЭлектроПласт» предлагает заключение долгосрочных отношений при поставках импортных электронных компонентов на взаимовыгодных условиях!

Наши преимущества:

- Оперативные поставки широкого спектра электронных компонентов отечественного и импортного производства напрямую от производителей и с крупнейших мировых складов;
- Поставка более 17-ти миллионов наименований электронных компонентов;
- Поставка сложных, дефицитных, либо снятых с производства позиций;
- Оперативные сроки поставки под заказ (от 5 рабочих дней);
- Экспресс доставка в любую точку России;
- Техническая поддержка проекта, помощь в подборе аналогов, поставка прототипов;
- Система менеджмента качества сертифицирована по Международному стандарту ISO 9001;
- Лицензия ФСБ на осуществление работ с использованием сведений, составляющих государственную тайну;
- Поставка специализированных компонентов (Xilinx, Altera, Analog Devices, Intersil, Interpoint, Microsemi, Aeroflex, Peregrine, Syfer, Eurofarad, Texas Instrument, Miteq, Cobham, E2V, MA-COM, Hittite, Mini-Circuits, General Dynamics и др.);

Помимо этого, одним из направлений компании «ЭлектроПласт» является направление «Источники питания». Мы предлагаем Вам помощь Конструкторского отдела:

- Подбор оптимального решения, техническое обоснование при выборе компонента;
- Подбор аналогов;
- Консультации по применению компонента;
- Поставка образцов и прототипов;
- Техническая поддержка проекта;
- Защита от снятия компонента с производства.



Как с нами связаться

Телефон: 8 (812) 309 58 32 (многоканальный)

Факс: 8 (812) 320-02-42

Электронная почта: org@eplast1.ru

Адрес: 198099, г. Санкт-Петербург, ул. Калинина, дом 2, корпус 4, литера А.