



■ Features

- Interchangeable AC plugs (plug kit sold sperately)
- Medical safety approved (2 × MOPP between primary to secondary)
- Suitable for BF application with appropriate system consideration
- Low leakage current <100 μ A
- No load power consumption< 0.075W
- Energy efficiency Level VI
- Comply with EISA 2007/DoE and EU ErP
- Class II power (without earth pin)
- Protections: Short circuit / Overload / Over voltage
- Fully enclosed plastic case
- Optional lock type DC plug
- 100% full load burn-in test
- 3 years warranty

■ Applications

- Blood glucose meter
- Blood pressure meter
- Nebulizer
- Inhaler
- Portable medical device
- Sleep apnea devices

■ Description

GEM18I is a highly reliable, 18W wall-mounted style single-output green medical adaptor series, which is compact and convenient for carry. This product is equipped with an interchangeable AC plug (4 types, including European type, USA type, U.K. type and Australian type) that makes it very suitable for businessmen to use in the major countries around the globe. GEM18I is a class II power unit (without FG), accepting the input range from 80VAC to 264VAC that it can satisfy the demands for various types of medical electrical devices. The circuitry design meets the international medical standards (2*MOPP), having an ultra low leakage current (<100 μ A), fitting the medical devices in direct electrical contact with the patients.

With the working efficiency up to 87% and the extremely low no-load power consumption below 0.075W, GEM18I is compliant with the latest USA energy regulation EISA 2007/DoE(Level VI) and EU ErP. The supreme feature allows the adaptor to save the energy when it is under either the operating mode or the standby mode. The entire series is approved for international safety regulations; moreover, it adopts the 94V-0 flame retardant plastic case that it can effectively prevent users from electric hazard.

■ Model Encoding

GEM18 I 05 -P1J

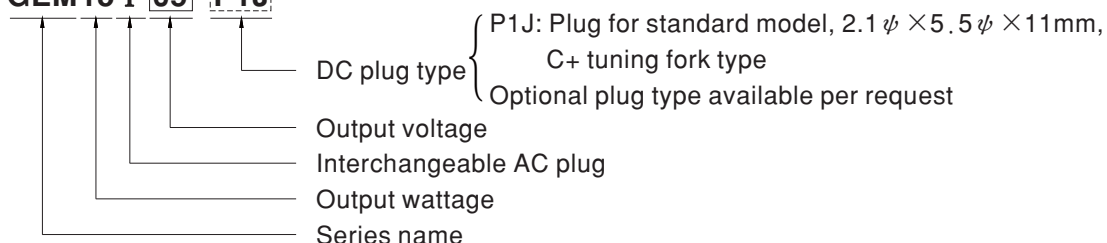

Interchangeable AC plug Specifically for GEM18I

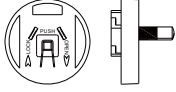
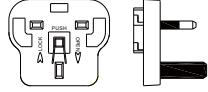
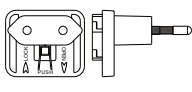
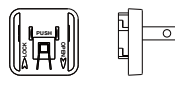
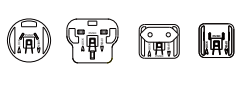
TYPE					
	Australian type	U.K type	European type	US type	Mix four type
ORDER NO.	AC plug-AU2	AC plug-UK2	AC plug-EU2	AC plug-US2	AC plug-MIX2

SPECIFICATION

ORDER NO.	GEM18I05-P1J	GEM18I09-P1J	GEM18I12-P1J	GEM18I15-P1J	GEM18I18-P1J	GEM18I24-P1J	GEM18I48-P1J	
OUTPUT	SAFETY MODEL NO.	GEM18I05	GEM18I09	GEM18I12	GEM18I15	GEM18I18	GEM18I24	GEM18I48
	DC VOLTAGE <small>Note.2</small>	5V	9V	12V	15V	18V	24V	48V
	RATED CURRENT	3A	2A	1.5A	1.2A	1A	0.75A	0.38A
	CURRENT RANGE	0 ~ 3A	0 ~ 2A	0 ~ 1.5A	0 ~ 1.2A	0 ~ 1A	0 ~ 0.75A	0 ~ 0.38A
	RATED POWER (max.)	15W	18W	18W	18W	18W	18W	18W
	RIPPLE & NOISE (max.) <small>Note.3</small>	60mVp-p	60mVp-p	80mVp-p	80mVp-p	80mVp-p	80mVp-p	80mVp-p
	VOLTAGE TOLERANCE <small>Note.4</small>	±5.0%	±5.0%	±3.0%	±3.0%	±2.0%	±2.0%	±2.0%
	LINE REGULATION <small>Note.5</small>	±1.0%	±1.0%	±1.0%	±1.0%	±1.0%	±1.0%	±1.0%
	LOAD REGULATION <small>Note.6</small>	±5.0%	±5.0%	±3.0%	±3.0%	±2.0%	±2.0%	±2.0%
SETUP, RISE, HOLD UP TIME	500ms, 30ms, 16ms/230VAC 500ms, 30ms, 16ms/115VAC at full load							
INPUT	VOLTAGE RANGE <small>Note.7</small>	80 ~ 264VAC 113 ~ 370VDC						
	FREQUENCY RANGE	47 ~ 63Hz						
	EFFICIENCY (Typ.)	80%	84%	84%	84%	84%	85%	87%
	AC CURRENT	0.45A / 115VAC 0.25A / 230VAC						
	INRUSH CURRENT (max.)	30A / 115VAC 60A / 230VAC						
LEAKAGE CURRENT(max.)	Touch current < 100µA/264VAC							
PROTECTION	OVERLOAD	105 ~ 160% rated output power Protection type : Hiccup mode, recovers automatically after fault condition is removed						
	OVER VOLTAGE	110 ~ 140% rated output voltage Protection type : Clamp by zener diode, output short						
ENVIRONMENT	WORKING TEMP.	-20 ~ +50°C (Refer to "Derating Curve")						
	WORKING HUMIDITY	20% ~ 90% RH non-condensing						
	STORAGE TEMP., HUMIDITY	-20 ~ +85°C, 10 ~ 95% RH						
	TEMP. COEFFICIENT	±0.03% / °C (0 ~ 40°C)						
SAFETY & EMC <small>(Note. 8)</small>	SAFETY STANDARDS	ANSI/AAMI ES60601-1 / 60601-1-11, TUV EN60601-1 / 60601-1-11 approved						
	WITHSTAND VOLTAGE	I/P-O/P:5656VDC						
	ISOLATION RESISTANCE	I/P-O/P:100M Ohms / 500VDC / 25°C / 70% RH						
	EMC EMISSION	Compliance to EN55011 class B, EN61000-3-2,3, FCC PART 15 / CISPR22 class B						
	EMC IMMUNITY	Compliance to EN61000-4,-2,3,4,5,6,8,11, light industry level, criteria A						
OTHERS	LIFE	3 years : 100% load 40°C, 12hours / day						
	MTBF	400Khrs min. MIL-HDBK-217F(25°C)						
	DIMENSION	75.5*39.1*56.2mm (L*W*H)						
	PACKING	140g ; 60pcs / 14kg / CARTON						
CONNECTOR	PLUG	See page 3 ; Other type available by customer requested						
	CABLE	See page 3 ; Other type available by customer requested						
NOTE	<ol style="list-style-type: none"> All parameters are specified at 230VAC input, rated load, 25°C 70% RH ambient. DC voltage: The output voltage set at point measure by plug terminal & 50% load. Ripple & noise are measured at 20MHz by using a 12" twisted pair terminated with a 0.1µf & 47µf capacitor. Tolerance: includes set up tolerance, line regulation, load regulation. Line regulation is measured from low line to high line at rated load. Load regulation is measured from 10% to 100% rated load. Derating may be needed under low input voltage. Please check the derating curve for more details. The power supply is considered as an independent unit, but the final equipment still need to re-confirm that the whole system complies with the EMC directives. For guidance on how to perform these EMC tests, please refer to "EMI testing of component power supplies." (as available on http://www.meanwell.com) 							

Derating Curve

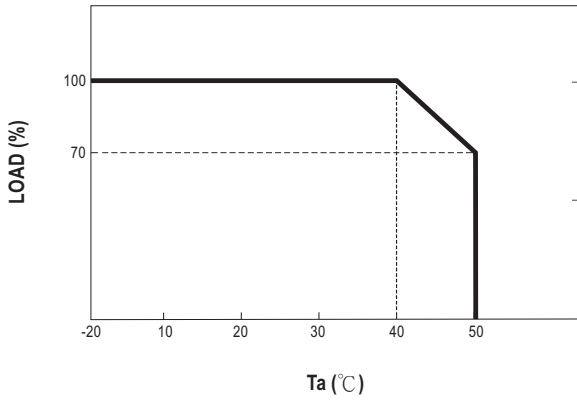

Static Characteristics

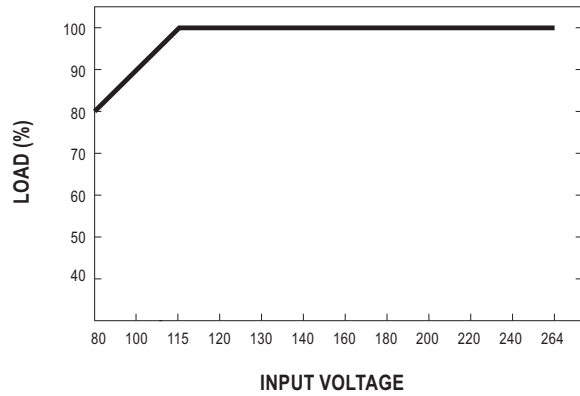

Mechanical Specification

Unit:mm

TYPE				
	Australian type	U.K type	European type	US type

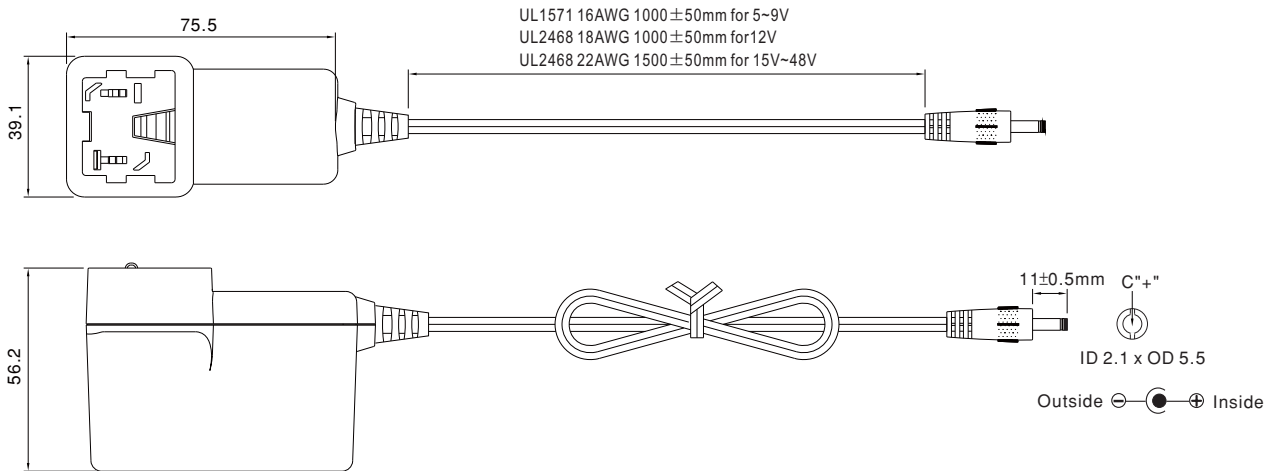

Plug Assignment

Standard plug: P1J

P1J	
P/N	OUTPUT
CENTER	+

Optional lock type plug: P2S

SWITCHCRAFT S761K plug equivalent

Installation Manual

Please refer to : <http://www.meanwell.com/webnet/search/InstallationSearch.html>



Компания «ЭлектроПласт» предлагает заключение долгосрочных отношений при поставках импортных электронных компонентов на взаимовыгодных условиях!

Наши преимущества:

- Оперативные поставки широкого спектра электронных компонентов отечественного и импортного производства напрямую от производителей и с крупнейших мировых складов;
- Поставка более 17-ти миллионов наименований электронных компонентов;
- Поставка сложных, дефицитных, либо снятых с производства позиций;
- Оперативные сроки поставки под заказ (от 5 рабочих дней);
- Экспресс доставка в любую точку России;
- Техническая поддержка проекта, помощь в подборе аналогов, поставка прототипов;
- Система менеджмента качества сертифицирована по Международному стандарту ISO 9001;
- Лицензия ФСБ на осуществление работ с использованием сведений, составляющих государственную тайну;
- Поставка специализированных компонентов (Xilinx, Altera, Analog Devices, Intersil, Interpoint, Microsemi, Aeroflex, Peregrine, Syfer, Eurofarad, Texas Instrument, Miteq, Cobham, E2V, MA-COM, Hittite, Mini-Circuits, General Dynamics и др.);

Помимо этого, одним из направлений компании «ЭлектроПласт» является направление «Источники питания». Мы предлагаем Вам помощь Конструкторского отдела:

- Подбор оптимального решения, техническое обоснование при выборе компонента;
- Подбор аналогов;
- Консультации по применению компонента;
- Поставка образцов и прототипов;
- Техническая поддержка проекта;
- Защита от снятия компонента с производства.



Как с нами связаться

Телефон: 8 (812) 309 58 32 (многоканальный)

Факс: 8 (812) 320-02-42

Электронная почта: org@eplast1.ru

Адрес: 198099, г. Санкт-Петербург, ул. Калинина, дом 2, корпус 4, литера А.