

Ledex[®] Tubular Linear Solenoids



Ledex® Tubular Solenoids

LINEAR Tubular



The Ledex® STA Series of tubular solenoids is available in three diameters and five sizes. Both push and pull types are available. Additionally, each size and type is available with a choice of two plunger configurations: flat face and 60°, as well as with or without an anti-rotation flat on the mounting bushing. These options offer maximum force for a wide range of applications. The new design also improves performance and provides longer life than previous tubular designs. They offer quiet operation and improved reliability for demanding applications.

Magnetic latching versions are available for some models, and many models are well suited for battery operation.

Pull versus Push Type

In Pull type solenoids, the plunger is pulled into the solenoid coil when the coil is energized. In Push type solenoids, the same is true, however, the plunger has a shaft extension which then pushes out through a hole in the end of the solenoid case. Please note, however, that the magnetic field cannot be reversed to cause the opposite action to occur.



- STA® Series has enhanced design features and improved performance
- Push and pull models
- Strokes up to 2-1/2"
- Life rating of 25 million actuations for STA designs



All catalog products manufactured after April 1, 2006 are RoHS Compliant

Performance Curves

The performance curves in this section serve as guides to determine the solenoid size needed to produce a desired force at a given stroke, duty cycle, and power source. All curves were developed under the following standard test conditions: ambient temperature of 20°C, 65% relative humidity.

Starting Force

When determining an application's force requirement, apply a 1.5 safety factor. For example: a load requiring 4.5 lb of force should utilize a solenoid providing 4.5 x 1.5 or 6.75 lb of force.

Duty Cycle

Duty cycle is determined by: ON time/(ON + OFF time).

For example: a solenoid is actuated for 30 seconds, then off for 90 seconds. $30 \text{ sec ON} / (30 \text{ Sec ON} + 90 \text{ sec OFF}) = 30/120 = 1/4$ or 25% duty cycle.

Ledex tubular solenoids are rated for various duty cycles ranging from continuous to 10% duty.

Note that maximum ON time for a particular application can be a factor which overrides the duty cycle rating. For example, at 25% duty cycle, the maximum ON time for a given Ledex solenoid is 36 seconds. If, however, the solenoid is operated at a cycle rate which enables the unit to return to ambient temperature between ON cycles, then the maximum ON time is extended somewhat. In the above example, this extended ON time is 44 seconds. Maximum ON time ratings are listed on the individual model specification pages.

Life

When selecting a tubular solenoid, as with any other solenoid style, it is important to consider the effects of heat on life. When used with a constant voltage supply, an increase in coil temperature reduces the work output and the life of the unit. Standard life is 25,000,000 actuations for STA designs.

Power Requirements

Voltage applied to the solenoid must be matched to the coil wire size for proper operation. Solenoids are cataloged in coil awgs ranging from #25 up to #37 to accommodate your input power.

Refer to the individual model specification pages for coil wire awg recommendations. Many other coil awg sizes are available. Please feel free to contact our application engineering department for availability.

Tubular Applications

The STA Series is particularly ideal for applications where field service is prohibitive. Its long life and high reliability are definite advantages in applications involving:

- Computer peripherals
- Industrial sewing machines
- Automated teller machines
- Blood analyzers
- Gate mechanisms
- Packaging machinery
- Door interlocks
- Sorting machines
- Glue dispensers
- Laboratory equipment
- Business machines

STA Construction

The STA is constructed with a low friction nylon bobbin which insures a 25 million actuations life rating on all models.

The problems associated with powdered metal flaking in typical tubular designs is eliminated with the metal-to-plastic bearing surface. In addition, the new design's case is rolled over both ends of the unit for greater shock and vibration integrity, allowing the STA to withstand severe applications in which typical solenoids may come apart.

Both push and pull models offer a built-in combination air gap spacer and plunger stop. This feature eliminates the need for external E-rings and impact washers which typically fail prematurely, as well as get in the way of your attached mechanisms.

All units are provided with 10" PVC lead wires as standard, and are rated for a maximum coil temperature of 130°C. UL-approved materials are used in the construction. For higher temperature applications up to 180°C, please consult the factory for alternate materials which are available in some models. Mechanical and electrical ratings may also be affected. Other options include: special plunger configurations, springs, special mounting flats on mounting bushings. Please consult the factory with details about your application as tooling may apply to some features.

STA Plunger Configurations

With two standard plunger configurations to choose from, the new STA Series offers stroke lengths up to 0.80" and up to 24 pounds of force.

A. Flat Face

For strokes typically less than 0.060", the flat face plunger is recommended with a pull or push force three to five times greater than 60° plungers.



B. 60° Angle

For longer strokes up to 0.80" (20.3 mm), the 60° plunger offers the greatest advantage over the flat face plunger.



Size 125 and 150 Standard Tubular Models for Large Loads

Ledex Size 125 and 150 standard tubular models are offered for heavy duty applications requiring larger forces. These standard models are all pull type and offered with 60° plungers. These models feature heavy duty welded mounting brackets or bushing mounts (depending on model), and heavy duty plunger stops to limit plunger travel, provide positive stopping, and keep pole faces from slamming together at the end of stroke.

An impact cushion made of resilient non-magnetic material absorbs energy at the end of the stroke. This cushion also helps eliminate residual magnetism.

Size 125 and 150 models are available with other plunger configurations, in push type models, and with other mountings. Please consult the factory as tooling may apply.

Ledex® Tubular Solenoids Selection

Tubular solenoids are available in a wide range of sizes, most of which are available in both push and pull types.

Use the selection overview chart to determine which size offers the desired performance and mechanical specifications.

Refer to the individual size specification pages for complete performance and mechanical data.

Options and Modified Designs

Even though many solenoid designs are in stock and available via distribution, our customers often require a product with unique features or performance capabilities. In fact, almost 80% of all solenoids that we make are either modified or custom built to meet our customers' exact application requirements.

So, if you don't find what you're looking for in the catalog, give us a call to discuss your needs with one of our application engineers.

Typical Examples of Custom Features



How to Use Tubular Performance Charts

- Select one of the four columns which provides the appropriate duty cycle. (For example 50%.)
- Reading down this column provides a variety of performance and electrical data including maximum on time, watts, and amp turns.
- Following down the column further into the VDC ratings, select the voltage which most closely matches your supply voltage. (For example, 11.5 for a 12 VDC power supply.)
- Read across (to the left) to select the awg suffix. (In this example, 32 awg is required, thus to order, specify: 195203-232.
Note that the digit preceding the awg refers to the plunger configuration and anti-rotation flat selected. The size 125 and 150 standard models do not use this plunger configuration and anti-rotation flat suffix system.

Performance

| Maximum Duty Cycle | 100% | 50% | 25% | 10% |
|--|------|-----|-----|------|
| Maximum ON Time (sec) when pulsed continuously | ∞ | 50 | 5 | 2 |
| Maximum ON Time (sec) for single pulse | ∞ | 140 | 30 | 8 |
| Watts (@ 20°C) | 4 | 8 | 16 | 40 |
| Ampere Turns (@ 20°C) | 497 | 704 | 994 | 1573 |

| Coil Data | | | | | | |
|-----------|--------------------|---------|-----------|-----------|-----------|-----------|
| awg (0XX) | Resistance (@20°C) | # Turns | VDC (Nom) | VDC (Nom) | VDC (Nom) | VDC (Nom) |
| 27 | 1.43 | 306 | 2.4 | 3.4 | 4.8 | 7.6 |
| 28 | 1.95 | 342 | 2.8 | 3.9 | 5.6 | 8.8 |
| 29 | 3.84 | 508 | 3.9 | 5.5 | 7.8 | 12.4 |
| 30 | 5.29 | 572 | 4.6 | 6.5 | 9.2 | 14.5 |
| 31 | 9.56 | 795 | 6.2 | 8.8 | 12.4 | 19.6 |
| 32 | 16.54 | 1068 | 8.1 | 11.5 | 16.3 | 25.7 |
| 33 | 22.60 | 1194 | 9.5 | 13.4 | 19.0 | 30.0 |
| 34 | 37.41 | 1547 | 12.2 | 17.3 | 24.0 | 39.0 |
| 35 | 60.71 | 1976 | 15.6 | 22.0 | 31.0 | 49.0 |
| 36 | 96.19 | 2475 | 19.6 | 28.0 | 39.0 | 62.0 |
| 37 | 149.93 | 3060 | 24.5 | 35.0 | 49.0 | 77.0 |

| Size | Solenoid Type | Package Dimension (in) | | Max Stroke (in) | Nominal Stroke (in) | Force (lbs) @ Nominal Stroke and Specified Duty Cycle | | | |
|-------------------------------------|-----------------|------------------------|--------|-----------------|---------------------|---|------|------|------|
| | | Dia. | Length | | | 100% | 50% | 25% | 10% |
| Size 50–STA-Mini 1/2" x 1/2" ●◆★☆☆ | Pull | 0.52 | 0.55 | 0.10 | 0.05 | 0.18 | 0.38 | 0.65 | 1.00 |
| Size 50–STA -Mini 1/2" x 1/2" ●★□☆☆ | Pull - Latching | 0.52 | 0.62 | 0.15 | 0.075 | – | 0.25 | 0.48 | 0.75 |
| Size 50–STA-Mini 1/2" x 1/2" ●◆★☆☆ | Push | 0.52 | 0.55 | 0.10 | 0.05 | 0.11 | 0.18 | 0.33 | 0.56 |
| Size 51–STA 1/2" x 1" ●◆★☆☆ | Pull | 0.52 | 1.05 | 0.50 | 0.10 | 0.21 | 0.35 | 0.58 | 1.00 |
| Size 51–STA 1/2" x 1" ●◆★☆☆ | Push | 0.52 | 1.05 | 0.50 | 0.10 | 0.15 | 0.25 | 0.47 | 0.91 |
| Size 75–STA 3/4" x 1-1/2" ●◆★☆☆ | Pull | 0.77 | 1.55 | 0.70 | 0.30 | 0.30 | 0.65 | 1.20 | 2.15 |
| Size 75–STA 3/4" x 1-1/2" ●◆★☆☆ | Push | 0.77 | 1.55 | 0.70 | 0.30 | 0.25 | 0.55 | 1.15 | 2.15 |
| Size 75Q–STA-Q 3/4" x 1-5/8" ●◆★☆☆ | Pull | 0.77 | 1.60 | 1.20 | 0.70 | 0.30 | 0.58 | 0.97 | 1.68 |
| Size 75D–STA-D 3/4" x 1-5/8" ●◆★☆☆ | Pull | 0.77 | 1.60 | 0.70 | 0.20 | 0.50 | 0.90 | 1.40 | 2.40 |
| Size 75D–STA-D 3/4" x 1-5/8" ●◆★☆☆ | Push | 0.77 | 1.60 | 0.70 | 0.20 | 0.38 | 0.75 | 1.40 | 2.60 |
| Size 102–STA 1" x 1-1/8" ◆★☆☆ | Pull | 1.02 | 1.18 | 0.50 | 0.20 | 0.75 | 1.50 | 2.80 | 5.80 |
| Size 100–STA 1" x 2" ◆★☆☆ | Pull | 1.02 | 2.05 | 0.70 | 0.30 | 0.65 | 1.60 | 3.00 | 5.20 |
| Size 100–STA 1" x 2" ◆★☆☆ | Push | 1.02 | 2.05 | 0.70 | 0.30 | 0.75 | 1.50 | 2.80 | 5.20 |
| Size 155–STA 1-1/2" x 1-1/2" ★☆☆ | Pull | 1.52 | 1.68 | 1.00 | 0.40 | 1.20 | 2.00 | 4.25 | 8.75 |
| Size 155–STA 1-1/2" x 1-1/2" ★☆☆ | Push | 1.52 | 1.68 | 0.75 | 0.40 | 0.70 | 1.50 | 2.80 | 6.30 |
| Size 125 1-1/4" x 2-1/4" | Pull | 1.25 | 2.25 | 0.75 | 0.40 | 1.00 | 2.00 | 4.00 | 6.50 |
| Size 150 1-1/2" x 2-1/2" | Pull | 1.50 | 2.50 | 0.75 | 0.40 | 1.00 | 2.50 | 5.20 | 9.80 |

All data is at 20°C coil temperature. Force outputs degrade with elevated temperatures.



Size 50–STA®-Mini Pull Tubular Solenoids — 1/2" Dia. x 1/2"

LINEAR Tubular

Part Number: 195200 - X XX

All products are RoHS Compliant

Coil AWG Number
(from performance chart below)

Plunger Configurations and anti-rotation flat on mounting
2 60° plunger without anti-rotation flat
6 60° plunger with anti-rotation flat

Performance

| | | | | |
|---|------|-----|-----|-----|
| Maximum Duty Cycle | 100% | 50% | 25% | 10% |
| Maximum ON Time (sec) when pulsed continuously ¹ | ∞ | 50 | 5 | 2 |
| Maximum ON Time (sec) for single pulse ² | ∞ | 140 | 30 | 8 |
| Watts (@ 20°C) | 3 | 6 | 12 | 30 |
| Ampere Turns (@ 20°C) | 268 | 379 | 536 | 847 |

Coil Data

| avg (0XX) ³ | Resistance (@20°C) | # Turns ⁴ | VDC (Nom) | VDC (Nom) | VDC (Nom) | VDC (Nom) |
|------------------------|--------------------|----------------------|-----------|-----------|-----------|-----------|
| 27 | 0.48 | 108 | 1.2 | 1.7 | 2.4 | 3.8 |
| 28 | 0.67 | 123 | 1.5 | 2.1 | 2.9 | 4.6 |
| 29 | 1.33 | 184 | 1.9 | 2.7 | 3.9 | 6.1 |
| 30 | 1.80 | 204 | 2.4 | 3.3 | 4.7 | 7.5 |
| 31 | 3.33 | 290 | 3.1 | 4.4 | 6.2 | 9.7 |
| 32 | 4.57 | 325 | 3.8 | 5.3 | 7.5 | 11.9 |
| 33 | 7.80 | 432 | 4.8 | 6.8 | 9.7 | 15.3 |
| 34 | 13.10 | 567 | 6.2 | 8.8 | 12.4 | 19.6 |
| 35 | 17.80 | 630 | 7.6 | 11.0 | 15.0 | 24.0 |
| 36 | 29.05 | 808 | 9.6 | 14.0 | 19.0 | 30.0 |
| 37 | 45.70 | 1008 | 12.2 | 17.0 | 24.0 | 38.0 |

- ¹ Continuously pulsed at stated watts and duty cycle
- ² Single pulse at stated watts (with coil at ambient room temperature 20°C)
- ³ Other coil awg sizes available — please consult factory
- ⁴ Reference number of turns

Specifications

| | |
|-------------------------------|---|
| Dielectric Strength | 500 VRMS |
| Recommended Minimum Heat Sink | Maximum watts dissipated by solenoid are based on an unrestricted flow of air at 20°C, with solenoid mounted on the equivalent of an aluminum plate measuring 2" square by 1/8" thick |
| Coil Resistance | ±5% tolerance |
| Weight | 0.51 oz (14.5 g) |
| Plunger Weight | 0.088 oz (2.5 g) |

How to Order

Add the plunger configuration, anti-rotation flat number, and the coil awg number to the part number (for example: to order a unit with a 60° plunger configuration without an anti-rotation flat rated for 4.7 VDC at 25% duty cycle, specify 195200-230).

Please see www.ledex.com for our list of stock products available through our North American distributors.

All specifications subject to change without notice.

Size 50-STA®-Mini Pull Tubular Solenoids — 1/2" Dia. x 1/2"

Typical Force @ 20°C



Typical Speed @ No Load, 20°C



Dimensions

Inches (mm)

All solenoids are illustrated in energized state



Size 50–STA®-Mini Pull Magnetic Latching Solenoid — 1/2" Dia. x 1/2"

LINEAR Tubular

Part Number: 151082 - X XX

All products are RoHS Compliant

Coil AWG Number
(from performance chart below)

Plunger Configurations and anti-rotation flat on mounting
 1 Flat Face plunger without anti-rotation flat on mounting
 2 60° plunger without anti-rotation flat on mounting
 5 Flat Face plunger with anti-rotation flat on mounting
 6 60° plunger with anti-rotation flat on mounting

Performance

| | Unlatched Voltage | 50% | 25% | 10% |
|---|-------------------|-----|-----|-----|
| Maximum Duty Cycle | | | | |
| Maximum ON Time (sec) when pulsed continuously ¹ | n/a | 50 | 5 | 2 |
| Watts (@ 20°C) | 3 | 6 | 12 | 30 |
| Ampere Turns (@ 20°C) | 268 | 379 | 536 | 847 |

Coil Data

| awg (0XX) ² | Resistance (@20°C) | # Turns ³ | Unlatched VDC | VDC (Nom) | VDC (Nom) | VDC (Nom) |
|------------------------|--------------------|----------------------|---------------|-----------|-----------|-----------|
| 27 | 0.48 | 108 | 1.2 | 1.7 | 2.4 | 3.8 |
| 28 | 0.67 | 123 | 1.5 | 2.1 | 2.9 | 4.6 |
| 29 | 1.33 | 184 | 1.9 | 2.7 | 4.0 | 6.1 |
| 30 | 1.80 | 204 | 2.4 | 3.3 | 4.7 | 7.5 |
| 31 | 3.33 | 290 | 3.1 | 4.4 | 6.2 | 9.7 |
| 32 | 4.57 | 325 | 3.8 | 5.3 | 7.5 | 11.9 |
| 33 | 7.80 | 432 | 4.8 | 6.8 | 9.7 | 15.3 |
| 34 | 13.10 | 567 | 6.2 | 8.8 | 12.4 | 20.0 |
| 35 | 17.80 | 630 | 7.6 | 11.0 | 15.0 | 24.0 |
| 36 | 29.05 | 808 | 9.6 | 14.0 | 19.0 | 30.0 |
| 37 | 45.70 | 1008 | 12.2 | 17.0 | 24.0 | 38.0 |

- ¹ Continuously pulsed at stated watts and duty cycle
- ² Other coil awg sizes available — please consult factory
- ³ Reference number of turns

Specifications

| | |
|-------------------------------|---|
| Operation | Pull |
| Dielectric Strength | 500 VRMS |
| Recommended Minimum Heat Sink | Maximum watts dissipated by solenoid are based on an unrestricted flow of air at 20°C, with solenoid mounted on the equivalent of an aluminum plate measuring 2" square by 1/8" thick |
| Unlatch Voltage | See schematic and coil data |
| Magnet Hold Force | 7.5 oz (with return spring) |
| Spring Force | 35.2 oz-in; 4.47 oz latched position |
| Weight | 0.52 oz (14.7 g) |
| Plunger Weight | 0.093 oz (2.6 g) |

How to Order

Add the plunger configuration, anti-rotation flat number, and the coil awg number to the part number (for example: to order a 60° plunger unit without an anti-rotation flat, rated for 4.7 VDC at 25% duty cycle, specify 151082-230).

Please see www.ledex.com for our list of stock products available through our North American distributors.

Coil Polarity

Latch: A+ B-

Unlatch: A- B+

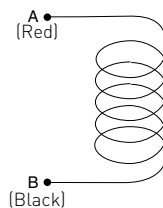

All specifications subject to change without notice.

Size 50-STA®-Mini Pull Magnetic Latching Solenoid — 1/2" Dia. x 1/2"

Typical Force @ 20°C (Net, with Spring)



Force values for reference only.

Dimensions

Inches (mm)

All solenoids are illustrated in energized state



Size 50–STA®-Mini Push Tubular Solenoids — 1/2" Dia. x 1/2"

Part Number: 195201-**X****XX**

All products are RoHS Compliant

LINEAR Tubular

Coil AWG Number
(from performance chart below)

Plunger Configurations and anti-rotation flat on mounting
2 60° plunger without anti-rotation flat
6 60° plunger with anti-rotation flat

Performance

| | 100% | 50% | 25% | 10% |
|---|------|-----|-----|-----|
| Maximum Duty Cycle | 100% | 50% | 25% | 10% |
| Maximum ON Time (sec) when pulsed continuously ¹ | ∞ | 50 | 5 | 2 |
| Maximum ON Time (sec) for single pulse ² | ∞ | 140 | 30 | 8 |
| Watts (@ 20°C) | 3 | 6 | 12 | 30 |
| Ampere Turns (@ 20°C) | 268 | 379 | 536 | 847 |

Coil Data

| awg (0XX) ³ | Resistance (@20°C) | # Turns ⁴ | VDC (Nom) | VDC (Nom) | VDC (Nom) | VDC (Nom) |
|------------------------|--------------------|----------------------|-----------|-----------|-----------|-----------|
| 27 | 0.48 | 108 | 1.2 | 1.7 | 2.4 | 3.8 |
| 28 | 0.67 | 123 | 1.5 | 2.1 | 2.9 | 4.6 |
| 29 | 1.33 | 184 | 1.9 | 2.7 | 3.9 | 6.1 |
| 30 | 1.80 | 204 | 2.4 | 3.3 | 4.7 | 7.5 |
| 31 | 3.33 | 290 | 3.1 | 4.4 | 6.2 | 9.7 |
| 32 | 4.57 | 325 | 3.8 | 5.3 | 7.5 | 11.9 |
| 33 | 7.80 | 432 | 4.8 | 6.8 | 9.7 | 15.3 |
| 34 | 13.10 | 567 | 6.2 | 8.8 | 12.4 | 19.6 |
| 35 | 17.80 | 630 | 7.6 | 11.0 | 15.0 | 24.0 |
| 36 | 29.05 | 808 | 9.6 | 14.0 | 19.0 | 30.0 |
| 37 | 45.70 | 1008 | 12.2 | 17.0 | 24.0 | 38.0 |

- Continuously pulsed at stated watts and duty cycle
- Single pulse at stated watts (with coil at ambient room temperature 20°C)
- Other coil awg sizes available — please consult factory
- Reference number of turns

Specifications

| | |
|-------------------------------|---|
| Dielectric Strength | 500 VRMS |
| Recommended Minimum Heat Sink | Maximum watts dissipated by solenoid are based on an unrestricted flow of air at 20°C, with solenoid mounted on the equivalent of an aluminum plate measuring 2" square by 1/8" thick |
| Coil Resistance | ±5% tolerance |
| Weight | 0.51 oz (14.5 g) |
| Plunger Weight | 0.04 oz (1.2 g) |

How to Order

Add the plunger configuration, anti-rotation flat number, and the coil awg number to the part number (for example: to order a unit with a 60° plunger configuration without an anti-rotation flat rated for 4.7 VDC at 25% duty cycle, specify 195201-230).

Please see www.ledex.com for our list of stock products available through our North American distributors.

All specifications subject to change without notice.

Size 50–STA®-Mini Push Tubular Solenoids — 1/2" Dia. x 1/2"

Typical Force @ 20°C



Typical Speed @ No Load, 20°C



Dimensions

Inches (mm)

All solenoids are illustrated in energized state



Size 51–STA® Pull Tubular Solenoids — 1/2" Dia. x 1"

LINEAR Tubular

Part Number: 195202 - X XX

All products are RoHS Compliant

Coil AWG Number
(from performance chart below)

Plunger Configurations and anti-rotation flat on mounting

- 1 Flat face plunger without anti-rotation flat
- 2 60° plunger without anti-rotation flat
- 5 Flat face plunger with anti-rotation flat
- 6 60° plunger with anti-rotation flat

Performance

| | 100% | 50% | 25% | 10% |
|---|------|-----|-----|------|
| Maximum Duty Cycle | 100% | 50% | 25% | 10% |
| Maximum ON Time (sec) when pulsed continuously ¹ | ∞ | 50 | 5 | 2 |
| Maximum ON Time (sec) for single pulse ² | ∞ | 140 | 30 | 8 |
| Watts (@ 20°C) | 4 | 8 | 16 | 40 |
| Ampere Turns (@ 20°C) | 497 | 704 | 994 | 1573 |

Coil Data

| awg (0XX) ³ | Resistance (@20°C) | # Turns ⁴ | VDC (Nom) | VDC (Nom) | VDC (Nom) | VDC (Nom) |
|------------------------|--------------------|----------------------|-----------|-----------|-----------|-----------|
| 27 | 1.43 | 306 | 2.4 | 3.4 | 4.8 | 7.6 |
| 28 | 1.95 | 342 | 2.8 | 3.9 | 5.6 | 8.8 |
| 29 | 3.84 | 508 | 3.9 | 5.5 | 7.8 | 12.4 |
| 30 | 5.29 | 572 | 4.6 | 6.5 | 9.2 | 14.5 |
| 31 | 9.56 | 795 | 6.2 | 8.8 | 12.4 | 19.6 |
| 32 | 16.54 | 1068 | 8.1 | 11.5 | 16.3 | 25.7 |
| 33 | 22.60 | 1194 | 9.5 | 13.4 | 19.0 | 30.0 |
| 34 | 37.41 | 1547 | 12.2 | 17.3 | 24.0 | 39.0 |
| 35 | 60.71 | 1976 | 15.6 | 22.0 | 31.0 | 49.0 |
| 36 | 96.19 | 2475 | 19.6 | 28.0 | 39.0 | 62.0 |
| 37 | 141.93 | 3060 | 23.8 | 33.7 | 47.6 | 75.3 |

- ¹ Continuously pulsed at stated watts and duty cycle
- ² Single pulse at stated watts (with coil at ambient room temperature 20°C)
- ³ Other coil awg sizes available — please consult factory
- ⁴ Reference number of turns

Specifications

| | |
|-------------------------------|---|
| Dielectric Strength | 500 VRMS |
| Recommended Minimum Heat Sink | Maximum watts dissipated by solenoid are based on an unrestricted flow of air at 20°C, with solenoid mounted on the equivalent of an aluminum plate measuring 2" square by 1/8" thick |
| Coil Resistance | ±5% tolerance |
| Holding Force | Flat Face: 1.18 lb (5.3 N) @ 20°C 60°: 0.90 lb (4.0 N) @ 20°C |
| Weight | 0.87 oz (24.7 g) |
| Plunger Weight | 0.16 oz (4.5 g) |

How to Order

Add the plunger configuration, anti-rotation flat number, and the coil awg number to the part number (for example: to order a unit with a 60° plunger configuration without an anti-rotation flat rated for 4.8 VDC at 25% duty cycle, specify 195202-227).

Please see www.ledex.com for our list of stock products available through our North American distributors.

All specifications subject to change without notice.

Size 51-STA® Pull Tubular Solenoids — 1/2" Dia. x 1"

Flat Face Plunger

Typical Force @ 20°C



Typical Speed @ No Load, 20°C



60° Plunger

Typical Force @ 20°C



Typical Speed @ No Load, 20°C



Force values for reference only.

Dimensions



Size 51–STA® Push Tubular Solenoids — 1/2" Dia. x 1"

LINEAR Tubular

Part Number: 195203 - X XX

All products are RoHS Compliant

Coil AWG Number
(from performance chart below)

Plunger Configurations and anti-rotation flat on mounting

- 1 Flat face plunger without anti-rotation flat
- 2 60° plunger without anti-rotation flat
- 5 Flat face plunger with anti-rotation flat
- 6 60° plunger with anti-rotation flat

Performance

| | | | | |
|---|------|-----|-----|------|
| Maximum Duty Cycle | 100% | 50% | 25% | 10% |
| Maximum ON Time (sec) when pulsed continuously ¹ | ∞ | 50 | 5 | 2 |
| Maximum ON Time (sec) for single pulse ² | ∞ | 140 | 30 | 8 |
| Watts (@ 20°C) | 4 | 8 | 16 | 40 |
| Ampere Turns (@ 20°C) | 497 | 704 | 994 | 1573 |

Coil Data

| awg (0XX) ³ | Resistance (@20°C) | # Turns ⁴ | VDC (Nom) | VDC (Nom) | VDC (Nom) | VDC (Nom) |
|------------------------|--------------------|----------------------|-----------|-----------|-----------|-----------|
| 27 | 1.43 | 306 | 2.4 | 3.4 | 4.8 | 7.6 |
| 28 | 1.95 | 342 | 2.8 | 3.9 | 5.6 | 8.8 |
| 29 | 3.84 | 508 | 3.9 | 5.5 | 7.8 | 12.4 |
| 30 | 5.29 | 572 | 4.6 | 6.5 | 9.2 | 14.5 |
| 31 | 9.56 | 795 | 6.2 | 8.8 | 12.4 | 19.6 |
| 32 | 16.54 | 1068 | 8.1 | 11.5 | 16.3 | 25.7 |
| 33 | 22.60 | 1194 | 9.5 | 13.4 | 19.0 | 30.0 |
| 34 | 37.41 | 1547 | 12.2 | 17.3 | 24.0 | 39.0 |
| 35 | 60.71 | 1976 | 15.6 | 22.0 | 31.0 | 49.0 |
| 36 | 96.19 | 2475 | 19.6 | 28.0 | 39.0 | 62.0 |
| 37 | 141.93 | 3060 | 23.8 | 33.7 | 47.6 | 75.3 |

- ¹ Continuously pulsed at stated watts and duty cycle
- ² Single pulse at stated watts (with coil at ambient room temperature 20°C)
- ³ Other coil awg sizes available — please consult factory
- ⁴ Reference number of turns

Specifications

| | |
|-------------------------------|---|
| Dielectric Strength | 500 VRMS |
| Recommended Minimum Heat Sink | Maximum watts dissipated by solenoid are based on an unrestricted flow of air at 20°C, with solenoid mounted on the equivalent of an aluminum plate measuring 2" square by 1/8" thick |
| Coil Resistance | ±5% tolerance |
| Holding Force | Flat Face: 1.00 lb (4.5 N) @ 20°C 60°: 0.71 lb (3.2 N) @ 20°C |
| Weight | 0.89 oz (25.2 g) |
| Plunger Weight | 0.11 oz (3.1 g) |

How to Order

Add the plunger configuration, anti-rotation flat number and the coil awg number to the part number (for example: to order a unit with a 60° plunger configuration without anti-rotation rated for 4.8 VDC at 25% duty cycle, specify 195203-227).

Please see www.ledex.com for our list of stock products available through our North American distributors.

All specifications subject to change without notice.

Size 51-STA® Push Tubular Solenoids — 1/2" Dia. x 1"

Flat Face Plunger

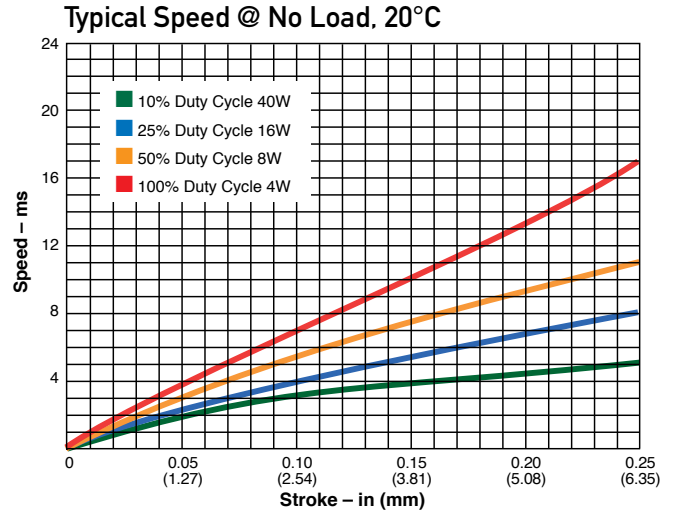

60° Plunger

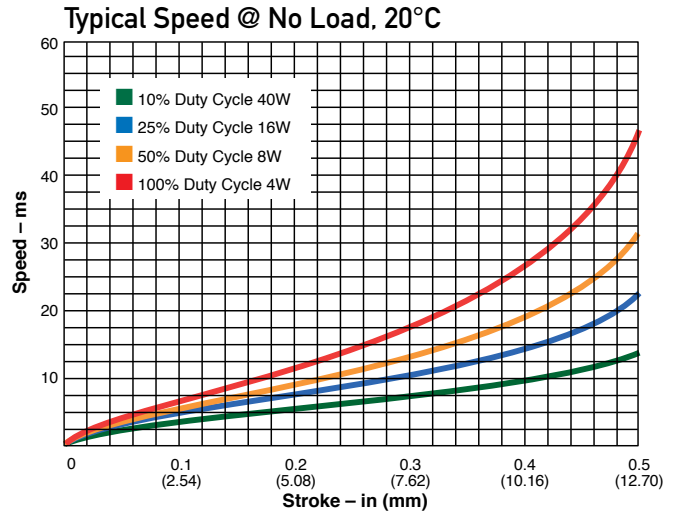

Force values for reference only.

Dimensions



Size 75–STA® Pull Tubular Solenoids — 3/4" Dia. x 1-1/2"

LINEAR Tubular

Part Number: 195204 - X XX

All products are RoHS Compliant

Coil AWG Number
(from performance chart below)

Plunger Configurations and anti-rotation flat on mounting

- 1 Flat face plunger without anti-rotation flat
- 2 60° plunger without anti-rotation flat
- 5 Flat face plunger with anti-rotation flat
- 6 60° plunger with anti-rotation flat

Performance

| | 100% | 50% | 25% | 10% |
|---|------|------|------|------|
| Maximum Duty Cycle | 100% | 50% | 25% | 10% |
| Maximum ON Time (sec) when pulsed continuously ¹ | ∞ | 230 | 25 | 6 |
| Maximum ON Time (sec) for single pulse ² | ∞ | 265 | 63 | 15 |
| Watts (@ 20°C) | 7 | 14 | 28 | 70 |
| Ampere Turns (@ 20°C) | 855 | 1200 | 1700 | 2700 |

Coil Data

| awg (0XX) ³ | Resistance (@20°C) | # Turns ⁴ | VDC (Nom) | VDC (Nom) | VDC (Nom) | VDC (Nom) |
|------------------------|--------------------|----------------------|-----------|-----------|-----------|-----------|
| 24 | 1.10 | 330 | 2.7 | 3.8 | 5.6 | 8.8 |
| 25 | 2.13 | 488 | 3.9 | 5.5 | 7.7 | 12.2 |
| 26 | 2.90 | 544 | 4.5 | 6.4 | 9.0 | 14.2 |
| 27 | 5.27 | 760 | 6.1 | 8.6 | 12.1 | 19.2 |
| 28 | 9.15 | 1026 | 8.0 | 11.3 | 16.0 | 25.0 |
| 29 | 12.50 | 1146 | 9.4 | 13.2 | 18.7 | 30.0 |
| 30 | 20.70 | 1491 | 12.0 | 17.0 | 24.0 | 38.0 |
| 31 | 33.60 | 1904 | 15.0 | 22.0 | 31.0 | 48.0 |
| 32 | 53.50 | 2394 | 19.4 | 27.0 | 39.0 | 61.0 |
| 33 | 83.50 | 2970 | 24.0 | 34.0 | 48.0 | 76.0 |

- ¹ Continuously pulsed at stated watts and duty cycle
- ² Single pulse at stated watts (with coil at ambient room temperature 20°C)
- ³ Other coil awg sizes available — please consult factory
- ⁴ Reference number of turns

Specifications

| | |
|-------------------------------|---|
| Dielectric Strength | 1000 VRMS |
| Recommended Minimum Heat Sink | Maximum watts dissipated by solenoid are based on an unrestricted flow of air at 20°C, with solenoid mounted on the equivalent of an aluminum plate measuring 3" square by 1/8" thick |
| Coil Resistance | ±5% tolerance |
| Holding Force | Flat Face: 5.24 lb (23.3 N) @ 20°C 60°: 2.88 lb (12.8 N) @ 20°C |
| Weight | 2.95 oz (83.6 g) |
| Plunger Weight | 0.71oz (20.1 g) |

How to Order

Add the plunger number and the coil awg number to the part number (for example: to order a unit with a 60° plunger configuration without an anti-rotation flat rated for 12.1 VDC at 25% duty cycle, specify 195204-227).

Please see www.ledex.com for our list of stock products available through our North American distributors.

All specifications subject to change without notice.

Size 75–STA® Pull Tubular Solenoids — 3/4" Dia. x 1-1/2"

Flat Face Plunger

Typical Force @ 20°C



Typical Speed @ No Load, 20°C



60° Plunger

Typical Force @ 20°C



Typical Speed @ No Load, 20°C



Force values for reference only.

Dimensions



Size 75–STA® Push Tubular Solenoids — 3/4" Dia. x 1-1/2"

LINEAR Tubular

Part Number: 195205 - X XX

All products are RoHS Compliant

Coil AWG Number
(from performance chart below)

Plunger Configurations and anti-rotation flat on mounting

- 1 Flat face plunger without anti-rotation flat
- 2 60° plunger without anti-rotation flat
- 5 Flat face plunger with anti-rotation flat
- 6 60° plunger with anti-rotation flat

Performance

| | 100% | 50% | 25% | 10% |
|---|------|------|------|------|
| Maximum Duty Cycle | 100% | 50% | 25% | 10% |
| Maximum ON Time (sec) when pulsed continuously ¹ | ∞ | 230 | 25 | 6 |
| Maximum ON Time (sec) for single pulse ² | ∞ | 265 | 63 | 15 |
| Watts (@ 20°C) | 7 | 14 | 28 | 70 |
| Ampere Turns (@ 20°C) | 855 | 1200 | 1700 | 2700 |

Coil Data

| awg (0XX) ³ | Resistance (@20°C) | # Turns ⁴ | VDC (Nom) | VDC (Nom) | VDC (Nom) | VDC (Nom) |
|------------------------|--------------------|----------------------|-----------|-----------|-----------|-----------|
| 24 | 1.10 | 330 | 2.7 | 3.8 | 5.6 | 8.8 |
| 25 | 2.13 | 488 | 3.9 | 5.5 | 7.7 | 12.2 |
| 26 | 2.90 | 544 | 4.5 | 6.4 | 9.0 | 14.2 |
| 27 | 5.27 | 760 | 6.1 | 8.6 | 12.1 | 19.2 |
| 28 | 9.15 | 1026 | 8.0 | 11.3 | 16.0 | 25.0 |
| 29 | 12.50 | 1146 | 9.4 | 13.2 | 18.7 | 30.0 |
| 30 | 20.70 | 1491 | 12.0 | 17.0 | 24.0 | 38.0 |
| 31 | 33.60 | 1904 | 15.0 | 22.0 | 31.0 | 48.0 |
| 32 | 53.50 | 2394 | 19.4 | 27.0 | 39.0 | 61.0 |
| 33 | 83.50 | 2970 | 24.0 | 34.0 | 48.0 | 76.0 |

- ¹ Continuously pulsed at stated watts and duty cycle
- ² Single pulse at stated watts (with coil at ambient room temperature 20°C)
- ³ Other coil awg sizes available — please consult factory
- ⁴ Reference number of turns

Specifications

| | |
|-------------------------------|---|
| Dielectric Strength | 1000 VRMS |
| Recommended Minimum Heat Sink | Maximum watts dissipated by solenoid are based on an unrestricted flow of air at 20°C, with solenoid mounted on the equivalent of an aluminum plate measuring 3" square by 1/8" thick |
| Coil Resistance | ±5% tolerance |
| Holding Force | Flat Face: 4.95 lb (22.0 N) @ 20°C 60°: 2.85 lb (12.7 N) @ 20°C |
| Weight | 3.08 oz (87.3 g) |
| Plunger Weight | 0.53 oz (15.0 g) |

How to Order

Add the plunger number and the coil awg number to the part number (for example: to order a unit with a 60° plunger configuration without an anti-rotation flat rated for 12.1 VDC at 25% duty cycle, specify 195205-227.

Please see www.ledex.com for our list of stock products available through our North American distributors.

All specifications subject to change without notice.

Size 75–STA® Push Tubular Solenoids — 3/4" Dia. x 1-1/2"

Flat Face Plunger

Typical Force @ 20°C



Typical Speed @ No Load, 20°C



60° Plunger

Typical Force @ 20°C



Typical Speed @ No Load, 20°C

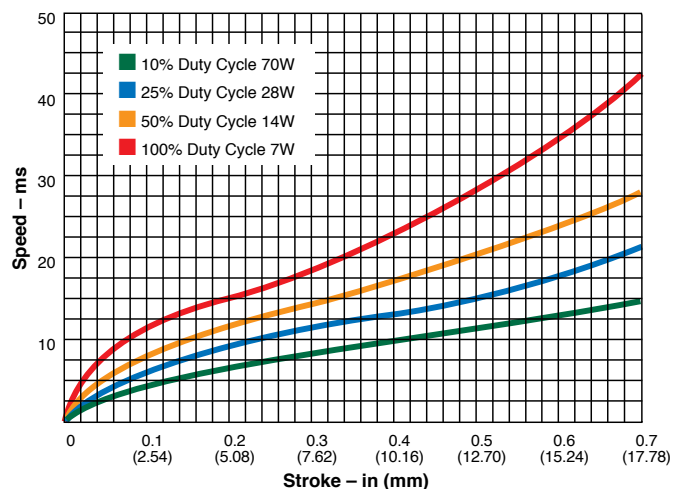

Force values for reference only.

Dimensions



Size 75Q–STA®-Q Pull Tubular — 3/4" Dia. x 1-5/8"

Part Number: 153556 - X XX

All products are RoHS Compliant

LINEAR Tubular

Coil AWG Number
(from performance chart below)

Plunger Configurations and anti-rotation flat on mounting
1 Flat face plunger without anti-rotation flat
5 Flat face plunger with anti-rotation flat

Performance

| | 100% | 50% | 25% | 10% |
|---|------|------|------|------|
| Maximum Duty Cycle | 100% | 50% | 25% | 10% |
| Maximum ON Time (sec) when pulsed continuously ¹ | ∞ | 230 | 25 | 6 |
| Maximum ON Time (sec) for single pulse ² | ∞ | 265 | 63 | 15 |
| Watts (@ 20°C) | 7 | 14 | 28 | 70 |
| Ampere Turns (@ 20°C) | 855 | 1200 | 1700 | 2700 |

Coil Data

| awg (0XX) ³ | Resistance (@20°C) | # Turns ⁴ | VDC (Nom) | VDC (Nom) | VDC (Nom) | VDC (Nom) |
|------------------------|--------------------|----------------------|-----------|-----------|-----------|-----------|
| 24 | 1.10 | 330 | 2.7 | 3.8 | 5.6 | 8.8 |
| 25 | 2.13 | 488 | 3.9 | 5.5 | 7.7 | 12.2 |
| 26 | 2.90 | 544 | 4.5 | 6.4 | 9.0 | 14.2 |
| 27 | 5.27 | 760 | 6.1 | 8.6 | 12.1 | 19.2 |
| 28 | 9.15 | 1026 | 8.0 | 11.3 | 16.0 | 25.0 |
| 29 | 12.50 | 1146 | 9.4 | 13.2 | 18.7 | 30.0 |
| 30 | 20.70 | 1491 | 12.0 | 17.0 | 24.0 | 38.0 |
| 31 | 33.60 | 1904 | 15.0 | 22.0 | 31.0 | 48.0 |
| 32 | 53.50 | 2394 | 19.4 | 27.0 | 39.0 | 61.0 |
| 33 | 83.50 | 2970 | 24.0 | 34.0 | 48.0 | 76.0 |

- Continuously pulsed at stated watts and duty cycle
- Single pulse at stated watts (with coil at ambient room temperature 20°C)
- Other coil awg sizes available — please consult factory
- Reference number of turns

Specifications

| | |
|-------------------------------|---|
| Dielectric Strength | 1000 VRMS |
| Recommended Minimum Heat Sink | Maximum watts dissipated by solenoid are based on an unrestricted flow of air at 20°C, with solenoid mounted on the equivalent of an aluminum plate measuring 3" square by 1/8" thick |
| Coil Resistance | ±5% tolerance |
| Sound Level | < 50 dBA typical (Plunger end-of-travel – 0.70 stroke and 100% duty power – impact noise recorded with sound meter 2.0" from solenoid, suspended as a free body) |
| Weight | 2.72 oz (77.0 g) |
| Plunger Weight | 0.78 oz (22.0 g) |

How to Order

Add the plunger number and the coil awg number to the part number (for example: to order a unit with a 60° plunger configuration without an anti-rotation flat rated for 12.1 VDC at 25% duty cycle, specify 153556-227.

Please see www.ledex.com for our list of stock products available through our North American distributors.

All specifications subject to change without notice.

Size 75Q-STA®-Q Pull Tubular — 3/4" Dia. x 1-5/8"

Typical Force @ 20°C



Force values for reference only.

Typical Speed @ No Load, 20°C



Dimensions



Size 75D–STA®-D Pull Tubular — 3/4" Dia. x 1-5/8"

LINEAR Tubular



Part Number: 153550 - X XX

All products are RoHS Compliant

Coil AWG Number
(from performance chart below)

Plunger Configurations and anti-rotation flat on mounting
2 60° plunger without anti-rotation flat
6 60° plunger with anti-rotation flat

Performance

| | | | | | |
|--|---|------|------|------|------|
|  VDC Battery Powered | Maximum Duty Cycle | 100% | 50% | 25% | 10% |
| | Maximum ON Time (sec) when pulsed continuously ¹ | ∞ | 230 | 25 | 6 |
|  High Speed | Maximum ON Time (sec) for single pulse ² | ∞ | 265 | 63 | 15 |
| | Watts (@ 20°C) | 7 | 14 | 28 | 70 |
| | Ampere Turns (@ 20°C) | 855 | 1200 | 1700 | 2700 |

Coil Data

| avg (0XX) ³ | Resistance (@20°C) | # Turns ⁴ | VDC (Nom) | VDC (Nom) | VDC (Nom) | VDC (Nom) |
|------------------------|--------------------|----------------------|-----------|-----------|-----------|-----------|
| 24 | 1.10 | 330 | 2.7 | 3.8 | 5.6 | 8.8 |
| 25 | 2.13 | 488 | 3.9 | 5.5 | 7.7 | 12.2 |
| 26 | 2.90 | 544 | 4.5 | 6.4 | 9.0 | 14.2 |
| 27 | 5.27 | 760 | 6.1 | 8.6 | 12.1 | 19.2 |
| 28 | 9.15 | 1026 | 8.0 | 11.3 | 16.0 | 25.0 |
| 29 | 12.50 | 1146 | 9.4 | 13.2 | 18.7 | 30.0 |
| 30 | 20.70 | 1491 | 12.0 | 17.0 | 24.0 | 38.0 |
| 31 | 33.60 | 1904 | 15.0 | 22.0 | 31.0 | 48.0 |
| 32 | 53.50 | 2394 | 19.4 | 27.0 | 39.0 | 61.0 |
| 33 | 83.50 | 2970 | 24.0 | 34.0 | 48.0 | 76.0 |

- Continuously pulsed at stated watts and duty cycle
- Single pulse at stated watts (with coil at ambient room temperature 20°C)
- Other coil awg sizes available — please consult factory
- Reference number of turns

Specifications

| | |
|-------------------------------|---|
| Dielectric Strength | 1000 VRMS |
| Recommended Minimum Heat Sink | Maximum watts dissipated by solenoid are based on an unrestricted flow of air at 20°C, with solenoid mounted on the equivalent of an aluminum plate measuring 3" square by 1/8" thick |
| Coil Resistance | ±5% tolerance |
| Sound Level | 75 dBA typical (Plunger end-of-travel – 0.70 stroke and 100% duty power – impact noise recorded with sound meter 2.0" from solenoid, suspended as a free body) |
| Holding Force | 2.62 lb (11.7 N) @ 20°C |
| Weight | 2.95 oz (83.6 g) |
| Plunger Weight | 0.71 oz (20.1 g) |

How to Order

Add the plunger number and the coil awg number to the part number (for example: to order a unit with a 60° plunger configuration without an anti-rotation flat rated for 12.1 VDC at 25% duty cycle, specify 153550-227.

Please see www.ledex.com for our list of stock products available through our North American distributors.

All specifications subject to change without notice.

Size 75D-STA®-D Pull Tubular — 3/4" Dia. x 1-5/8"

Typical Force @ 20°C

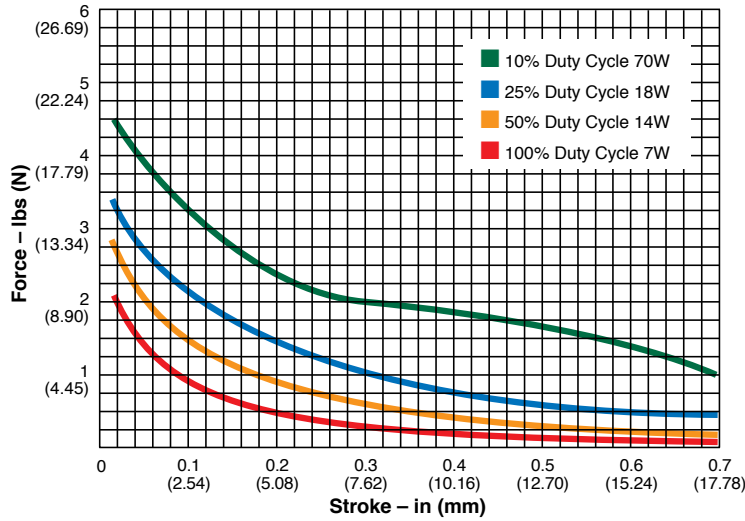

Force values for reference only.

Typical Speed @ No Load, 20°C



Dimensions



Size 75D–STA®-D Push Tubular — 3/4" Dia. x 1-5/8"

LINEAR Tubular



Part Number: 153553 - X XX

All products are RoHS Compliant

Coil AWG Number
(from performance chart below)

Plunger Configurations and anti-rotation flat on mounting
2 60° plunger without anti-rotation flat
6 60° plunger with anti-rotation flat

Performance

| | | | | | |
|--|---|------|------|------|------|
|  VDC Battery Powered | Maximum Duty Cycle | 100% | 50% | 25% | 10% |
| | Maximum ON Time (sec) when pulsed continuously ¹ | ∞ | 230 | 25 | 6 |
|  High Speed | Maximum ON Time (sec) for single pulse ² | ∞ | 265 | 63 | 15 |
| | Watts (@ 20°C) | 7 | 14 | 28 | 70 |
| | Ampere Turns (@ 20°C) | 855 | 1200 | 1700 | 2700 |

Coil Data

| awg (0XX) ³ | Resistance (@20°C) | # Turns ⁴ | VDC (Nom) | VDC (Nom) | VDC (Nom) | VDC (Nom) |
|------------------------|--------------------|----------------------|-----------|-----------|-----------|-----------|
| 24 | 1.10 | 330 | 2.7 | 3.8 | 5.6 | 8.8 |
| 25 | 2.13 | 488 | 3.9 | 5.5 | 7.7 | 12.2 |
| 26 | 2.90 | 544 | 4.5 | 6.4 | 9.0 | 14.2 |
| 27 | 5.27 | 760 | 6.1 | 8.6 | 12.1 | 19.2 |
| 28 | 9.15 | 1026 | 8.0 | 11.3 | 16.0 | 25.0 |
| 29 | 12.50 | 1146 | 9.4 | 13.2 | 18.7 | 30.0 |
| 30 | 20.70 | 1491 | 12.0 | 17.0 | 24.0 | 38.0 |
| 31 | 33.60 | 1904 | 15.0 | 22.0 | 31.0 | 48.0 |
| 32 | 53.50 | 2394 | 19.4 | 27.0 | 39.0 | 61.0 |
| 33 | 83.50 | 2970 | 24.0 | 34.0 | 48.0 | 76.0 |

- ¹ Continuously pulsed at stated watts and duty cycle
- ² Single pulse at stated watts (with coil at ambient room temperature 20°C)
- ³ Other coil awg sizes available — please consult factory
- ⁴ Reference number of turns

Specifications

| | |
|-------------------------------|---|
| Dielectric Strength | 1000 VRMS |
| Recommended Minimum Heat Sink | Maximum watts dissipated by solenoid are based on an unrestricted flow of air at 20°C, with solenoid mounted on the equivalent of an aluminum plate measuring 3" square by 1/8" thick |
| Coil Resistance | ±5% tolerance |
| Sound Level | 75 dBA typical (Plunger end-of-travel – 0.70 stroke and 100% duty power – impact noise recorded with sound meter 2.0" from solenoid, suspended as a free body) |
| Holding Force | 2.46 lb (10.9 N) @ 20°C |
| Weight | 3.08 oz (87.3 g) |
| Plunger Weight | 0.53 oz (15.0 g) |

How to Order

Add the plunger number and the coil awg number to the part number (for example: to order a unit with a 60° plunger configuration without an anti-rotation flat rated for 12.1 VDC at 25% duty cycle, specify 153553-227.

Please see www.ledex.com for our list of stock products available through our North American distributors.

All specifications subject to change without notice.

Size 75D-STA[®]-D Push Tubular — 3/4" Dia. x 1-5/8"

Typical Force @ 20°C



Typical Speed @ No Load, 20°C



Dimensions

Inches (mm)

All solenoids are illustrated in energized state



Size 102–STA® Pull Tubular Solenoids — 1" Dia. x 1-1/8"

Part Number: 152099 - X XX

All products are RoHS Compliant

LINEAR Tubular

Coil AWG Number
(from performance chart below)

Plunger Configurations and anti-rotation flat on mounting
 2 60° plunger without anti-rotation flat
 6 60° plunger with anti-rotation flat



Performance

| | 100% | 50% | 25% | 10% |
|---|------|------|------|------|
| Maximum Duty Cycle | 100% | 50% | 25% | 10% |
| Maximum ON Time (sec) when pulsed continuously ¹ | ∞ | 104 | 24 | 8 |
| Maximum ON Time (sec) for single pulse ² | ∞ | 187 | 55 | 18 |
| Watts (@ 20°C) | 8 | 16 | 32 | 80 |
| Ampere Turns (@ 20°C) | 718 | 1015 | 1435 | 2270 |

Coil Data

| awg (0XX) ³ | Resistance (@20°C) | # Turns ⁴ | VDC (Nom) | VDC (Nom) | VDC (Nom) | VDC (Nom) |
|------------------------|--------------------|----------------------|-----------|-----------|-----------|-----------|
| 23 | 0.88 | 240 | 2.7 | 3.8 | 5.3 | 8.4 |
| 24 | 1.23 | 272 | 3.1 | 4.4 | 6.3 | 9.9 |
| 25 | 2.23 | 380 | 4.2 | 6.0 | 8.4 | 13.3 |
| 26 | 3.85 | 510 | 5.6 | 7.8 | 11.1 | 17.6 |
| 27 | 5.32 | 576 | 6.5 | 9.2 | 13.0 | 20.6 |
| 28 | 8.83 | 749 | 8.4 | 11.9 | 16.8 | 26.6 |
| 29 | 14.35 | 960 | 10.7 | 15.1 | 21.4 | 33.8 |
| 30 | 22.78 | 1206 | 13.5 | 19.1 | 27.0 | 42.7 |
| 31 | 35.69 | 1500 | 16.9 | 23.9 | 33.8 | 53.4 |
| 32 | 54.90 | 1837 | 21.0 | 29.7 | 42.0 | 66.4 |
| 33 | 93.08 | 2431 | 27.3 | 38.6 | 54.6 | 86.3 |

- ¹ Continuously pulsed at stated watts and duty cycle
- ² Single pulse at stated watts (with coil at ambient room temperature 20°C)
- ³ Other coil awg sizes available — please consult factory
- ⁴ Reference number of turns

Specifications

| | |
|-------------------------------|---|
| Dielectric Strength | 1000 VRMS |
| Recommended Minimum Heat Sink | Maximum watts dissipated by solenoid are based on an unrestricted flow of air at 20°C, with solenoid mounted on the equivalent of an aluminum plate measuring 4" square by 1/8" thick |
| Coil Resistance | ±5% tolerance |
| Holding Force | 4.9 lbs (21.8 N) at 20°C |
| Weight | 3.8 oz (110 g) |
| Plunger Weight | 1 oz (28 g) |

How to Order

Add the plunger configuration and the coil awg number to the part number (for example: to order a unit with a 60° plunger configuration without an anti-rotation flat rated for 5.3 VDC at 25% duty cycle, specify 152099-225).

Please see www.ledex.com for our list of stock products available through our North American distributors.

All specifications subject to change without notice.

Size 102-STA® Pull Tubular Solenoids — 1" Dia. x 1-1/8"

Typical Force @ 20°C



Force values for reference only.

Dimensions

Inches (mm)

All solenoids are illustrated in energized state



Size 100–STA® Pull Tubular Solenoids — 1" Dia. x 2"

LINEAR Tubular

Part Number: 195206 - X XX

All products are RoHS Compliant

Coil AWG Number
(from performance chart below)

Plunger Configurations and anti-rotation flat on mounting

- 1 Flat face plunger without anti-rotation flat
- 2 60° plunger without anti-rotation flat
- 5 Flat face plunger with anti-rotation flat
- 6 60° plunger with anti-rotation flat

Performance

| | | | | |
|---|------|------|------|------|
| Maximum Duty Cycle | 100% | 50% | 25% | 10% |
| Maximum ON Time (sec) when pulsed continuously ¹ | ∞ | 360 | 32 | 8 |
| Maximum ON Time (sec) for single pulse ² | ∞ | 470 | 120 | 32 |
| Watts (@ 20°C) | 10 | 20 | 40 | 100 |
| Ampere Turns (@ 20°C) | 1166 | 1649 | 2332 | 3688 |

Coil Data

| awg (0XX) ³ | Resistance (@20°C) | # Turns ⁴ | VDC (Nom) | VDC (Nom) | VDC (Nom) | VDC (Nom) |
|------------------------|--------------------|----------------------|-----------|-----------|-----------|-----------|
| 23 | 1.96 | 536 | 4.4 | 6.3 | 8.9 | 14.0 |
| 24 | 2.69 | 600 | 5.2 | 7.3 | 10.4 | 16.4 |
| 25 | 4.89 | 840 | 7.0 | 9.9 | 14.0 | 22.0 |
| 26 | 8.70 | 1117 | 9.4 | 13.3 | 18.8 | 29.7 |
| 27 | 11.50 | 1260 | 10.7 | 15.2 | 21.0 | 34.0 |
| 28 | 19.20 | 1645 | 13.8 | 19.6 | 28.0 | 44.0 |
| 29 | 31.20 | 2104 | 17.7 | 25.0 | 35.0 | 56.0 |
| 30 | 49.60 | 2646 | 22.0 | 31.0 | 45.0 | 70.0 |
| 31 | 77.40 | 3280 | 28.0 | 39.0 | 56.0 | 88.0 |
| 32 | 119.00 | 4026 | 35.0 | 49.0 | 69.0 | 109.0 |
| 33 | 202.00 | 5317 | 45.0 | 64.0 | 90.0 | 142.0 |

- ¹ Continuously pulsed at stated watts and duty cycle
- ² Single pulse at stated watts (with coil at ambient room temperature 20°C)
- ³ Other coil awg sizes available — please consult factory
- ⁴ Reference number of turns

Specifications

| | |
|-------------------------------|---|
| Dielectric Strength | 1000 VRMS |
| Recommended Minimum Heat Sink | Maximum watts dissipated by solenoid are based on an unrestricted flow of air at 20°C, with solenoid mounted on the equivalent of an aluminum plate measuring 4" square by 1/8" thick |
| Coil Resistance | ±5% tolerance |
| Holding Force | Flat Face: 13.83 lb (61.5 N) @ 20°C 60°: 6.61 lb (29.4 N) @ 20°C |
| Weight | 6.96 oz (197.3 g) |
| Plunger Weight | 1.60 oz (45.4 g) |

How to Order

Add the plunger configuration number and the coil awg number to the part number (for example: to order a unit with a 60° plunger rated for 21 VDC at 25% duty cycle, specify 195206-227).

Please see www.ledex.com for our list of stock products available through our North American distributors.

All specifications subject to change without notice.

Size 100–STA® Pull Tubular Solenoids — 1" Dia. x 2"

Flat Face Plunger

Typical Force @ 20°C



Typical Speed @ No Load, 20°C



60° Plunger

Typical Force @ 20°C



Typical Speed @ No Load, 20°C



Force values for reference only.

Dimensions



Size 100–STA® Push Tubular Solenoids — 1" Dia. x 2"

LINEAR Tubular

Part Number: 195207 - X XX

All products are RoHS Compliant

Coil AWG Number
(from performance chart below)

Plunger Configurations and anti-rotation flat on mounting

- 1 Flat face plunger without anti-rotation flat
- 2 60° plunger without anti-rotation flat
- 5 Flat face plunger with anti-rotation flat
- 6 60° plunger with anti-rotation flat



Performance

| | 100% | 50% | 25% | 10% |
|---|------|------|------|------|
| Maximum Duty Cycle | 100% | 50% | 25% | 10% |
| Maximum ON Time (sec) when pulsed continuously ¹ | ∞ | 360 | 32 | 8 |
| Maximum ON Time (sec) for single pulse ² | ∞ | 470 | 120 | 32 |
| Watts (@ 20°C) | 10 | 20 | 40 | 100 |
| Ampere Turns (@ 20°C) | 1166 | 1649 | 2332 | 3688 |

Coil Data

| awg (0XX) ³ | Resistance (@20°C) | # Turns ⁴ | VDC (Nom) | VDC (Nom) | VDC (Nom) | VDC (Nom) |
|------------------------|--------------------|----------------------|-----------|-----------|-----------|-----------|
| 23 | 1.96 | 536 | 4.4 | 6.3 | 8.9 | 14.0 |
| 24 | 2.69 | 600 | 5.2 | 7.3 | 10.4 | 16.4 |
| 25 | 4.89 | 840 | 7.0 | 9.9 | 14.0 | 22.0 |
| 26 | 8.70 | 1117 | 9.4 | 13.3 | 18.8 | 29.7 |
| 27 | 11.50 | 1260 | 10.7 | 15.2 | 21.0 | 34.0 |
| 28 | 19.20 | 1645 | 13.8 | 19.6 | 28.0 | 44.0 |
| 29 | 31.20 | 2104 | 17.7 | 25.0 | 35.0 | 56.0 |
| 30 | 49.60 | 2646 | 22.0 | 31.0 | 45.0 | 70.0 |
| 31 | 77.40 | 3280 | 28.0 | 39.0 | 56.0 | 88.0 |
| 32 | 119.00 | 4026 | 35.0 | 49.0 | 69.0 | 109.0 |
| 33 | 202.00 | 5317 | 45.0 | 64.0 | 90.0 | 142.0 |

- ¹ Continuously pulsed at stated watts and duty cycle
- ² Single pulse at stated watts (with coil at ambient room temperature 20°C)
- ³ Other coil awg sizes available — please consult factory
- ⁴ Reference number of turns

Specifications

| | |
|-------------------------------|---|
| Dielectric Strength | 1000 VRMS |
| Recommended Minimum Heat Sink | Maximum watts dissipated by solenoid are based on an unrestricted flow of air at 20°C, with solenoid mounted on the equivalent of an aluminum plate measuring 4" square by 1/8" thick |
| Coil Resistance | ±5% tolerance |
| Holding Force | Flat Face: 11.82 lb (52.6 N) @ 20°C 60°: 6.49 lb (28.9 N) @ 20°C |
| Weight | 6.73 oz (190.8 g) |
| Plunger Weight | 1.19 oz (33.7 g) |

How to Order

Add the plunger configuration number and the coil awg number to the part number (for example: to order a unit with a 60° plunger rated for 21 VDC at 25% duty cycle, specify 195207-227).

Please see www.ledex.com for our list of stock products available through our North American distributors.

All specifications subject to change without notice.

Size 100-STA® Push Tubular Solenoids — 1" Dia. x 2"

Flat Face Plunger

Typical Force @ 20°C



Typical Speed @ No Load, 20°C



60° Plunger

Typical Force @ 20°C



Typical Speed @ No Load, 20°C



Force values for reference only.

Dimensions

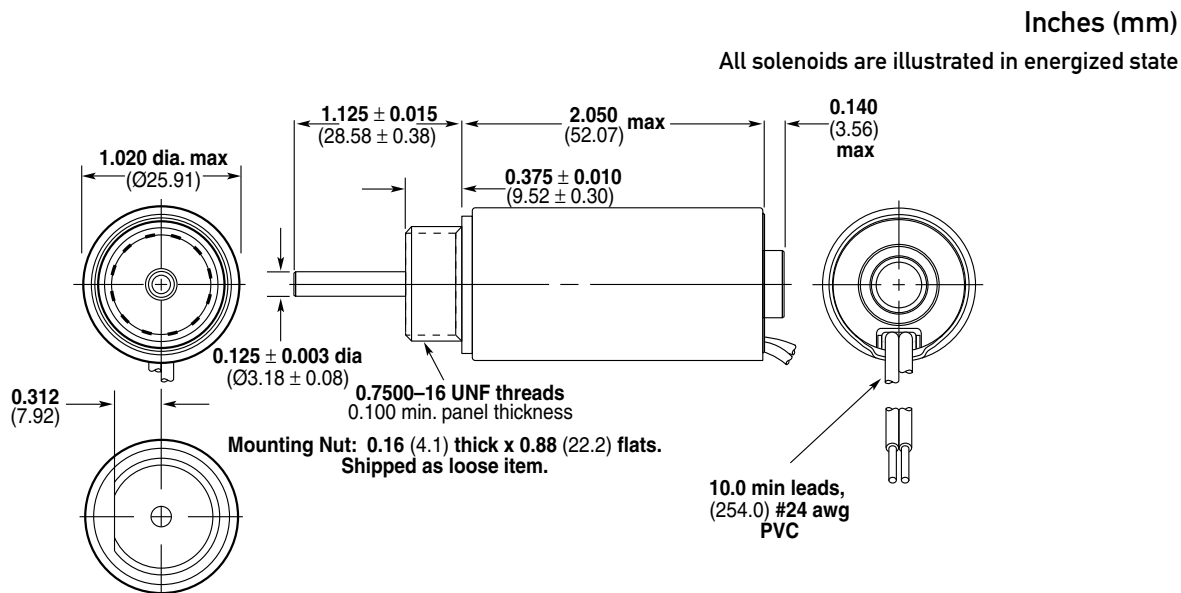

Size 155–STA® Pull Tubular Solenoids — 1-1/2" Dia. x 1-1/2"

LINEAR Tubular

Part Number: 152097 - X XX

All products are RoHS Compliant

Coil AWG Number
(from performance chart below)

Plunger Configurations and anti-rotation flat on mounting
2 60° plunger without anti-rotation flat
6 60° plunger with anti-rotation flat

Performance

| Maximum Duty Cycle | 100% | 50% | 25% | 10% |
|---|------|------|------|------|
| Maximum ON Time (sec) when pulsed continuously ¹ | ∞ | 338 | 66 | 20 |
| Maximum ON Time (sec) for single pulse ² | ∞ | 855 | 308 | 84 |
| Watts (@ 20°C) | 11 | 22 | 44 | 110 |
| Ampere Turns (@ 20°C) | 1339 | 1894 | 2678 | 4234 |

Coil Data

| awg (0XX) ³ | Resistance (@20°C) | # Turns ⁴ | VDC (Nom) | VDC (Nom) | VDC (Nom) | VDC (Nom) |
|------------------------|--------------------|----------------------|-----------|-----------|-----------|-----------|
| 23 | 4.74 | 900 | 7.2 | 10.2 | 14.4 | 22.8 |
| 24 | 7.41 | 1120 | 9.0 | 12.8 | 18.1 | 28.5 |
| 25 | 11.49 | 1386 | 11.2 | 15.9 | 22.5 | 35.6 |
| 26 | 17.51 | 1692 | 13.9 | 19.6 | 27.8 | 43.9 |
| 27 | 29.37 | 2212 | 18.0 | 25.4 | 35.9 | 56.8 |
| 28 | 43.70 | 2655 | 21.9 | 31.0 | 43.8 | 69.3 |
| 29 | 70.28 | 3366 | 27.8 | 39.3 | 55.6 | 87.9 |
| 30 | 110.6 | 4199 | 34.9 | 49.3 | 69.8 | 110.3 |
| 31 | 183.3 | 5434 | 44.9 | 63.5 | 89.8 | 142.0 |
| 32 | 279.1 | 6624 | 55.4 | 78.4 | 110.8 | 175.2 |
| 33 | 442.1 | 8289 | 69.7 | 98.6 | 139.5 | 220.5 |

¹ Continuously pulsed at stated watts and duty cycle

² Single pulse at stated watts (with coil at ambient room temperature 20°C)

³ Other coil awg sizes available — please consult factory

⁴ Reference number of turns

Specifications

| | |
|-------------------------------|---|
| Dielectric Strength | 1000 VRMS |
| Recommended Minimum Heat Sink | Maximum watts dissipated by solenoid are based on an unrestricted flow of air at 20°C, with solenoid mounted on the equivalent of an aluminum plate measuring 6" square by 1/8" thick |
| Coil Resistance | ±5% tolerance |
| Holding Force | 9.7 lb (43.15 N) @ 20°C |
| Weight | 11.3 oz (320 g) |
| Plunger Weight | 1.6 oz (46 g) |

How to Order

Add the plunger configuration number and the coil awg number to the part number (for example: to order a unit with a 60° plunger without an anti-rotation flat rated for 14 VDC at 25% duty cycle, specify 152097-223).

Please see www.ledex.com for our list of stock products available through our North American distributors.

All specifications subject to change without notice.

Size 155–STA® Pull Tubular Solenoids — 1-1/2" Dia. x 1-1/2"

Typical Force @ 20°C



Force values for reference only.

Typical Speed @ 20°C



Dimensions

Inches (mm)

All solenoids are illustrated in energized state



Size 155–STA® Push Tubular Solenoids — 1-1/2" Dia. x 1-1/2"

LINEAR Tubular

Part Number: 153205 - X XX

All products are RoHS Compliant

Coil AWG Number
(from performance chart below)

Plunger Configurations and anti-rotation flat on mounting
2 60° plunger without anti-rotation flat
6 60° plunger with anti-rotation flat

Performance

| | 100% | 50% | 25% | 10% |
|---|------|------|------|------|
| Maximum Duty Cycle | 100% | 50% | 25% | 10% |
| Maximum ON Time (sec) when pulsed continuously ¹ | ∞ | 338 | 66 | 20 |
| Maximum ON Time (sec) for single pulse ² | ∞ | 855 | 308 | 84 |
| Watts (@ 20°C) | 11 | 22 | 44 | 110 |
| Ampere Turns (@ 20°C) | 1339 | 1894 | 2678 | 4234 |

Coil Data

| awg (0XX) ³ | Resistance (@20°C) | # Turns ⁴ | VDC (Nom) | VDC (Nom) | VDC (Nom) | VDC (Nom) |
|------------------------|--------------------|----------------------|-----------|-----------|-----------|-----------|
| 23 | 4.74 | 900 | 7.2 | 10.2 | 14.4 | 22.8 |
| 24 | 7.41 | 1120 | 9.0 | 12.8 | 18.1 | 28.5 |
| 25 | 11.49 | 1386 | 11.2 | 15.9 | 22.5 | 35.6 |
| 26 | 17.51 | 1692 | 13.9 | 19.6 | 27.8 | 43.9 |
| 27 | 29.37 | 2212 | 18.0 | 25.4 | 35.9 | 56.8 |
| 28 | 43.70 | 2655 | 21.9 | 31.0 | 43.8 | 69.3 |
| 29 | 70.28 | 3366 | 27.8 | 39.3 | 55.6 | 87.9 |
| 30 | 110.6 | 4199 | 34.9 | 49.3 | 69.8 | 110.3 |
| 31 | 183.3 | 5434 | 44.9 | 63.5 | 89.8 | 142.0 |
| 32 | 279.1 | 6624 | 55.4 | 78.4 | 110.8 | 175.2 |
| 33 | 442.1 | 8289 | 69.7 | 98.6 | 139.5 | 220.5 |

¹ Continuously pulsed at stated watts and duty cycle

² Single pulse at stated watts (with coil at ambient room temperature 20°C)

³ Other coil awg sizes available — please consult factory

⁴ Reference number of turns

Specifications

| | |
|-------------------------------|---|
| Dielectric Strength | 1000 VRMS |
| Recommended Minimum Heat Sink | Maximum watts dissipated by solenoid are based on an unrestricted flow of air at 20°C, with solenoid mounted on the equivalent of an aluminum plate measuring 6" square by 1/8" thick |
| Coil Resistance | ±5% tolerance |
| Holding Force | 8.2 lb (36.52 N) @ 20°C |
| Weight | 11.3 oz (320 g) |
| Plunger Weight | 1.3 oz (37 g) |

How to Order

Add the plunger configuration number and the coil awg number to the part number (for example: to order a unit with a 60° plunger without an anti-rotation flat rated for 14 VDC at 25% duty cycle, specify 153205-223).

Please see www.ledex.com for our list of stock products available through our North American distributors.

All specifications subject to change without notice.

Size 155–STA® Push Tubular Solenoids — 1-1/2" Dia. x 1-1/2"

Typical Force @ 20°C



Force values for reference only.

Typical Speed @ 20°C



Dimensions

Inches (mm)

All solenoids are illustrated in energized state



Ledex® Size 125 Pull Tubular Solenoids — 1-1/4" Dia. x 2-1/4"

Part Number: 174419-0XX

All products are RoHS Compliant

LINEAR Tubular

Coil AWG Number
(from performance chart below)

Performance

| | | | | |
|---|------|------|------|------|
| Maximum Duty Cycle | 100% | 50% | 25% | 10% |
| Maximum ON Time (sec) when pulsed continuously ¹ | ∞ | 390 | 60 | 18 |
| Maximum ON Time (sec) for single pulse ² | ∞ | 510 | 160 | 45 |
| Watts (@ 20°C) | 13 | 26 | 52 | 130 |
| Ampere Turns (@ 20°C) | 1500 | 2121 | 3000 | 4743 |

Coil Data

| awg (0XX) ³ | Resistance (@20°C) | # Turns ⁴ | VDC (Nom) | VDC (Nom) | VDC (Nom) | VDC (Nom) |
|------------------------|--------------------|----------------------|-----------|-----------|-----------|-----------|
| 23 | 3.52 | 780 | 6.8 | 9.6 | 13.6 | 22.0 |
| 24 | 6.04 | 1056 | 8.6 | 12.2 | 17.2 | 27.0 |
| 25 | 8.47 | 1176 | 10.9 | 15.4 | 22.0 | 34.0 |
| 26 | 14.10 | 1540 | 13.8 | 19.5 | 28.0 | 44.0 |
| 27 | 22.50 | 1970 | 17.3 | 24.0 | 35.0 | 55.0 |
| 28 | 36.10 | 2484 | 22.0 | 31.0 | 44.0 | 69.0 |
| 29 | 55.10 | 3060 | 27.0 | 38.0 | 54.0 | 86.0 |
| 30 | 88.10 | 3805 | 35.0 | 49.0 | 70.0 | 110.0 |
| 31 | 147.00 | 5044 | 44.0 | 62.0 | 88.0 | 139.0 |
| 32 | 214.00 | 5992 | 54.0 | 76.0 | 107.0 | 170.0 |
| 33 | 354.00 | 7744 | 69.0 | 98.0 | 138.0 | 218.0 |

- ¹ Continuously pulsed at stated watts and duty cycle
- ² Single pulse at stated watts (with coil at ambient room temperature 20°C)
- ³ Other coil awg sizes available — please consult factory
- ⁴ Reference number of turns

Specifications

| | |
|-------------------------------|---|
| Dielectric Strength | 1000 VRMS |
| Recommended Minimum Heat Sink | Maximum watts dissipated by solenoid are based on an unrestricted flow of air at 20°C, with solenoid mounted on the equivalent of an aluminum plate measuring 5" square by 1/8" thick |
| Coil Resistance | ±5% tolerance |
| Holding Force | 9 lbs (40.0 N) @ 20°C |
| Weight | 10.41 oz (295 g) |
| Plunger Weight | 1.87 oz (53.2 g) |

How to Order

Add the coil awg number (0XX) to the part number (for example: to order a 25% duty cycle unit rated at 35 VDC, specify 174419-027).

Please see www.ledex.com for our list of stock products available through our North American distributors.

All specifications subject to change without notice.

Ledex® Size 125 Pull Tubular Solenoids — 1-1/4" Dia. x 2-1/4"

Typical Force @ 20°C



Force values for reference only.

Typical Speed @ No Load, 20°C



Dimensions

Inches (mm)

All solenoids are illustrated in energized state



Ledex® Size 150 Pull Tubular Solenoids — 1-1/2" Dia. x 2-1/2"

Part Number: 174432-0XX

All products are RoHS Compliant

LINEAR Tubular

Coil AWG Number
(from performance chart below)

Performance

| Maximum Duty Cycle | 100% | 50% | 25% | 10% |
|---|------|------|------|------|
| Maximum ON Time (sec) when pulsed continuously ¹ | ∞ | 420 | 100 | 25 |
| Maximum ON Time (sec) for single pulse ² | ∞ | 570 | 252 | 75 |
| Watts (@ 20°C) | 17 | 34 | 68 | 170 |
| Ampere Turns (@ 20°C) | 1800 | 2546 | 3600 | 5692 |

Coil Data

| awg (0XX) ³ | Resistance (@20°C) | # Turns ⁴ | VDC (Nom) | VDC (Nom) | VDC (Nom) | VDC (Nom) |
|------------------------|--------------------|----------------------|-----------|-----------|-----------|-----------|
| 23 | 5.58 | 1030 | 9.8 | 13.9 | 19.7 | 31.0 |
| 24 | 9.30 | 1344 | 12.4 | 17.6 | 25.0 | 39.0 |
| 25 | 14.90 | 1712 | 15.7 | 22.0 | 31.0 | 50.0 |
| 26 | 24.00 | 2180 | 19.9 | 28.0 | 40.0 | 63.0 |
| 27 | 36.90 | 2680 | 25.0 | 35.0 | 50.0 | 79.0 |
| 28 | 58.40 | 3322 | 32.0 | 45.0 | 63.0 | 100.0 |
| 29 | 87.50 | 4008 | 39.0 | 56.0 | 79.0 | 124.0 |
| 30 | 148.00 | 5292 | 50.0 | 71.0 | 101.0 | 159.0 |
| 31 | 224.00 | 6360 | 63.0 | 90.0 | 127.0 | 200.0 |
| 32 | 344.00 | 7956 | 78.0 | 110.0 | 155.0 | 246.0 |
| 33 | 554.00 | 10070 | 100.0 | 141.0 | 199.0 | 315.0 |

¹ Continuously pulsed at stated watts and duty cycle

² Single pulse at stated watts (with coil at ambient room temperature 20°C)

³ Other coil awg sizes available — please consult factory

⁴ Reference number of turns

Specifications

| | |
|-------------------------------|---|
| Dielectric Strength | 1000 VRMS |
| Recommended Minimum Heat Sink | Maximum watts dissipated by solenoid are based on an unrestricted flow of air at 20°C, with solenoid mounted on the equivalent of an aluminum plate measuring 6" square by 1/8" thick |
| Coil Resistance | ±5% tolerance |
| Holding Force | 14.5 lbs (64.5 N) at 20°C |
| Weight | 17 oz (481.8 g) |
| Plunger Weight | 3.35 oz (95.0 g) |

How to Order

Add the coil awg number (0XX) to the part number (for example: to order a 25% duty cycle unit rated at 50 VDC, specify 174432-027).

Please see www.ledex.com for our list of stock products available through our North American distributors.

All specifications subject to change without notice.

Ledex® Size 150 Pull Tubular Solenoids — 1-1/2" Dia. x 2-1/2"

Typical Force @ 20°C



Typical Speed @ No Load, 20°C



Dimensions

Inches (mm)

All solenoids are illustrated in energized state





Компания «ЭлектроПласт» предлагает заключение долгосрочных отношений при поставках импортных электронных компонентов на взаимовыгодных условиях!

Наши преимущества:

- Оперативные поставки широкого спектра электронных компонентов отечественного и импортного производства напрямую от производителей и с крупнейших мировых складов;
- Поставка более 17-ти миллионов наименований электронных компонентов;
- Поставка сложных, дефицитных, либо снятых с производства позиций;
- Оперативные сроки поставки под заказ (от 5 рабочих дней);
- Экспресс доставка в любую точку России;
- Техническая поддержка проекта, помощь в подборе аналогов, поставка прототипов;
- Система менеджмента качества сертифицирована по Международному стандарту ISO 9001;
- Лицензия ФСБ на осуществление работ с использованием сведений, составляющих государственную тайну;
- Поставка специализированных компонентов (Xilinx, Altera, Analog Devices, Intersil, Interpoint, Microsemi, Aeroflex, Peregrine, Syfer, Eurofarad, Texas Instrument, Miteq, Cobham, E2V, MA-COM, Hittite, Mini-Circuits, General Dynamics и др.);

Помимо этого, одним из направлений компании «ЭлектроПласт» является направление «Источники питания». Мы предлагаем Вам помощь Конструкторского отдела:

- Подбор оптимального решения, техническое обоснование при выборе компонента;
- Подбор аналогов;
- Консультации по применению компонента;
- Поставка образцов и прототипов;
- Техническая поддержка проекта;
- Защита от снятия компонента с производства.



Как с нами связаться

Телефон: 8 (812) 309 58 32 (многоканальный)

Факс: 8 (812) 320-02-42

Электронная почта: org@eplast1.ru

Адрес: 198099, г. Санкт-Петербург, ул. Калинина, дом 2, корпус 4, литера А.