

0.3 V Ultra-low Output Voltage 300 mA Buck DC/DC Converter

No.EA-519-190808

OVERVIEW

RP517x is a low-voltage resistance buck DC/DC converter featuring ultra-low 0.3 μA quiescent current and 0.3 V output voltage. Suitable for wearable and IoT devices which require long-life batteries and downsizing.

KEY BENEFITS

- Ultra-low consumption current (I_Q : 0.3 μA) with the VFM control for DC/DC (switching frequency: 1 MHz max.)
- Suitable for low power devices due to its ultra-low output voltage range from 0.3 V to 1.2 V
- Suitable for coin batteries and USB ports due to its wide input range from 1.8 V to 5.5 V
- Selectable 3 packages: WLCSP, DFN and SOT. Suitable for IC cards due to WLCSP's thickness of 0.4 mm and less.

KEY SPECIFICATIONS

- Output current: 300 mA
- Output Voltage Range: 0.3 V to 1.2 V
(Settable in 0.1 V step)
- Output Voltage Accuracy: ± 18 mV
- Built-in Driver On-resistance ($V_{IN} = 3.6$ V):
Typ. PMOS 0.15 Ω , NMOS 0.15 Ω (RP517Z)
- Standby Current: 0.01 μA

TYPICAL PERFORMANCE CHARACTERISTICS

RP517x051x, $T_a = 25^\circ\text{C}$

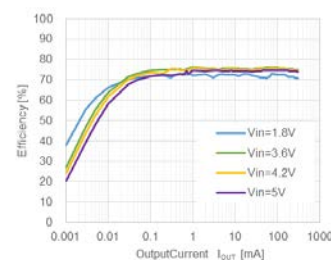

TYPICAL APPLICATIONS

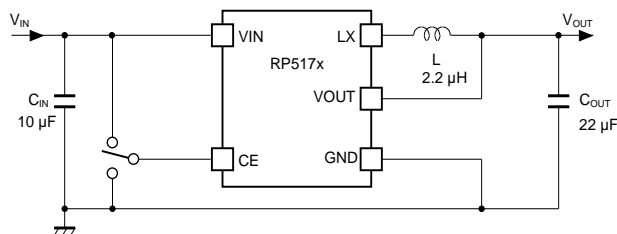

SELECTION GUIDE

Product Name	Package	Quantity per Reel
RP517Zxx1\$-TR-F	WLCSP-8-P1	5,000 pcs
RP517Kxx1\$-TR	DFN(PLP)2527-10	5,000 pcs
RP517Hxx1\$-T1-FE	SOT-89-5	1,000 pcs

xx: The set output voltage (V_{SET})
Fixed Output Voltage Type:
0.3 V (03) to 1.2 V (12) in 0.1 V step

\$: The auto-discharge option

Version	Auto-discharge Function	V_{SET}
C	No	0.3 V to 1.2 V
D	Yes	

PACKAGES (unit: mm)

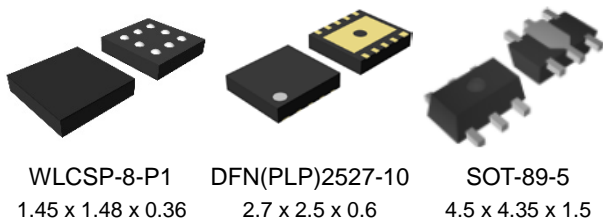

WLCSP-8-P1
1.45 x 1.48 x 0.36

DFN(PLP)2527-10
2.7 x 2.5 x 0.6

SOT-89-5
4.5 x 4.35 x 1.5

APPLICATIONS

- Wearable equipment such as SmartWatch, SmartBand and Health monitoring
- Li-ion battery-used equipment, Coin cell-used equipment
- Low power RF such as Bluetooth® Low Energy, Zigbee, WiSun and ANT
- Low power CPU, Memory, Sensor device and Energy harvester

RP517x

No.EA-519-190808

SELECTION GUIDE

The set output voltage, the auto-discharge function⁽¹⁾ and the packages are user-selectable options.

Selection Guide

Product Name	Package	Quantity per Reel	Pb Free	Halogen Free
RP517Zxx1\$-TR-F	WLCSP-8-P1	5,000 pcs	Yes	Yes
RP517Kxx1\$-TR	DFN(PLP)2527-10	5,000 pcs	Yes	Yes
RP517Hxx1\$-T1-FE	SOT-89-5	1,000 pcs	Yes	Yes

xx: Specify the set output voltage (V_{SET})

Fixed Output Voltage Type ⁽²⁾: 0.3 V (03) to 1.2 V (12) in 0.1 V step

\$: Select the auto-discharge option

Version	Auto-discharge Function	V_{SET}
C	No	0.3 V to 1.2 V
D	Yes	

⁽¹⁾ Auto-discharge function quickly lowers the output voltage to 0 V by releasing the electrical charge accumulated in the external capacitor, when the chip enable signal is switched from the active mode to the standby mode.

⁽²⁾ The custom specification of 0.05 V step is available.

BLOCK DIAGRAMS

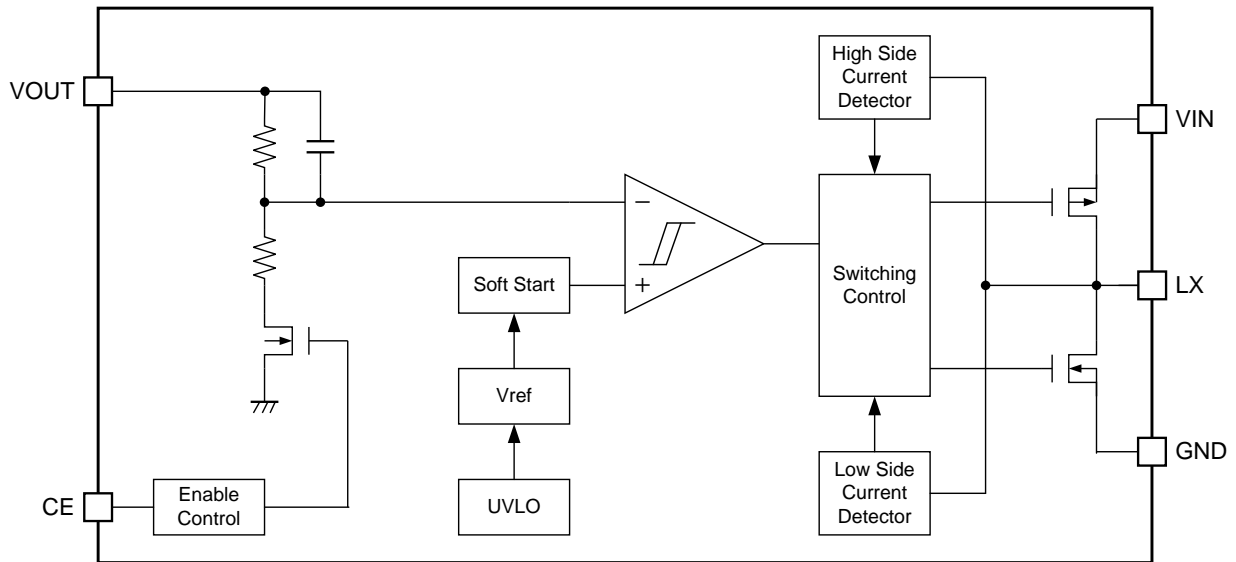

RP517xxx1C Block Diagram

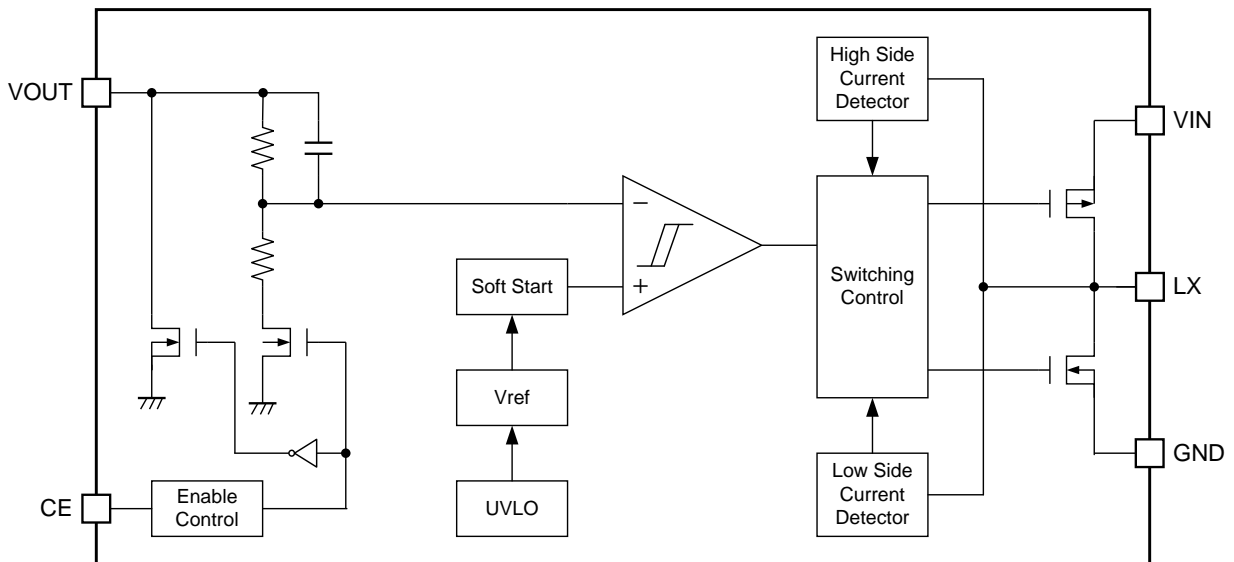

RP517xxx1D Block Diagram

PIN DESCRIPTIONS

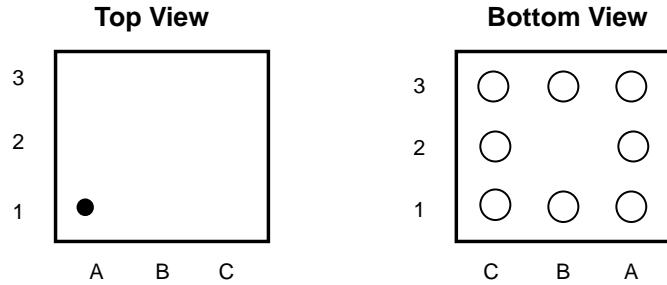

RP517Z (WLCSP-8-P1) Pin Configuration

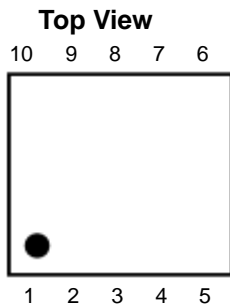

RP517K [DFN(PLP)2527-10] Pin Configuration

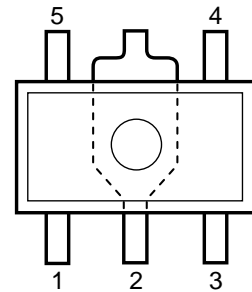
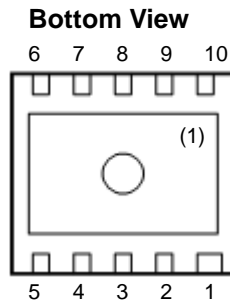

RP517H (SOT-89-5) Pin Configuration

RP517Z (WLCSP-8-P1) Pin Descriptions

Pin No.	Symbol	Description
A1	VIN	Input Pin
B1	VIN	Input Pin
C1	LX	Switching Pin
A2	VOUT	Output Pin
C2	GND	Ground Pin
A3	CE	Chip Enable Pin (Active-high)
B3	GND	Ground Pin
C3	GND	Ground Pin

⁽¹⁾ The tab on the bottom of the package enhances thermal performance and is electrically connected to GND (substrate level). It is recommended that the tab be connected to the ground plane on the board, or otherwise be left floating.

RP517K [DFN(PLP)2527-10] Pin Descriptions

Pin No.	Symbol	Description
1	VOUT	Output Pin
2	GND	Ground Pin
3	GND	Ground Pin
4	LX	Switching Pin
5	LX	Switching Pin
6	VIN	Input Pin
7	VIN	Input Pin
8	NC	No connection
9	CE	Chip Enable Pin (Active-high)
10	NC	No connection

RP517H (SOT-89-5) Pin Descriptions

Pin No.	Symbol	Description
1	VOUT	Output Pin
2	GND	Ground Pin
3	LX	Switching Pin
4	VIN	Input Pin
5	CE	Chip Enable Pin (Active-high)

RP517x

No.EA-519-190808

ABSOLUTE MAXIMUM RATINGS

Absolute Maximum Ratings

Symbol	Parameter	Rating	Unit	
V_{IN}	Input Pin Voltage	-0.3 to 6.5	V	
V_{LX}	LX Pin Voltage	-0.3 to $V_{IN} + 0.3$	V	
V_{CE}	CE Pin Voltage	-0.3 to 6.5	V	
V_{OUT}	VOUT Pin Voltage	-0.3 to 6.5	V	
P_D	Power Dissipation ⁽¹⁾	WLCSP-8-P1, JEDEC STD. 51	840	mW
		DFN(PLP)2527-10, JEDEC STD. 51	2500	mW
		SOT-89-5, JEDEC STD. 51	2600	mW
T_j	Junction Temperature Range	-40 to 125	°C	
T_{stg}	Storage Temperature Range	-55 to 125	°C	

ABSOLUTE MAXIMUM RATINGS

Electronic and mechanical stress momentarily exceeded absolute maximum ratings may cause permanent damage and may degrade the lifetime and safety for both device and system using the device in the field. The functional operation at or over these absolute maximum ratings is not assured.

RECOMMENDED OPERATING CONDITIONS

Recommended Operating Conditions

Symbol	Parameter	Rating	Unit
V_{IN}	Input Voltage	1.8 to 5.5	V
T_a	Operating Temperature Range	-40 to 85	°C

RECOMMENDED OPERATING CONDITIONS

All of electronic equipment should be designed that the mounted semiconductor devices operate within the recommended operating conditions. The semiconductor devices cannot operate normally over the recommended operating conditions, even if they are used over such conditions by momentary electronic noise or surge. And the semiconductor devices may receive serious damage when they continue to operate over the recommended operating conditions.

⁽¹⁾ Refer to *POWER DISSIPATION* for detailed information.

ELECTRICAL CHARACTERISTICS

The specifications surrounded by are guaranteed by design engineering at $-40^{\circ}\text{C} \leq T_a \leq 85^{\circ}\text{C}$.

RP517x Electrical Characteristics

($T_a = 25^{\circ}\text{C}$)

Symbol	Parameter	Condition	Min.	Typ.	Max.	Unit
V_{OUT}	Output Voltage	$V_{\text{IN}} = V_{\text{CE}} = 3.6 \text{ V}$	-0.018		+0.018	V
I_{Q}	Operating Quiescent Current	$V_{\text{IN}} = V_{\text{CE}} = V_{\text{OUT}} = 5.5 \text{ V}$, $V_{\text{SET}} = 0.6 \text{ V}$, at rest		0.3		μA
I_{STANDBY}	Standby Current	$V_{\text{IN}} = 5.5 \text{ V}$, $V_{\text{CE}} = 0 \text{ V}$		0.01	0.5	μA
I_{CEH}	CE Pin Input Current, high	$V_{\text{IN}} = V_{\text{CE}} = 5.5 \text{ V}$	-0.025	0	0.025	μA
I_{CEL}	CE Pin Input Current, low	$V_{\text{IN}} = 5.5 \text{ V}$, $V_{\text{CE}} = 0 \text{ V}$	-0.025	0	0.025	μA
I_{VOUTH}	VOUT pin input current, high	$V_{\text{IN}} = V_{\text{OUT}} = 5.5 \text{ V}$, $V_{\text{CE}} = 0 \text{ V}$	-0.025	0	0.025	μA
I_{VOUTL}	VOUT pin input current, low	$V_{\text{IN}} = 5.5 \text{ V}$, $V_{\text{CE}} = V_{\text{OUT}} = 0 \text{ V}$	-0.025	0	0.025	μA
R_{DISN}	Auto-discharge NMOS On-state Resistance ⁽¹⁾	$V_{\text{IN}} = 3.6 \text{ V}$, $V_{\text{CE}} = 0 \text{ V}$		60		Ω
V_{CEH}	CE Pin Input Voltage, high	$1.8 \text{ V} \leq V_{\text{IN}} \leq 5.5 \text{ V}$	1.0			V
V_{CEL}	CE Pin Input Voltage, low	$1.8 \text{ V} \leq V_{\text{IN}} \leq 5.5 \text{ V}$			0.4	V
R_{ONP}	PMOS on-resistance	RP517Z	$V_{\text{IN}} = 3.6 \text{ V}$, $I_{\text{LX}} = -100 \text{ mA}$		0.15	Ω
		RP517K	$V_{\text{IN}} = 3.6 \text{ V}$, $I_{\text{LX}} = -100 \text{ mA}$		0.19	Ω
		RP517H	$V_{\text{IN}} = 3.6 \text{ V}$, $I_{\text{LX}} = -100 \text{ mA}$		0.19	Ω
R_{ONN}	NMOS on-resistance	RP517Z	$V_{\text{IN}} = 3.6 \text{ V}$, $I_{\text{LX}} = -100 \text{ mA}$		0.15	Ω
		RP517K	$V_{\text{IN}} = 3.6 \text{ V}$, $I_{\text{LX}} = -100 \text{ mA}$		0.19	Ω
		RP517H	$V_{\text{IN}} = 3.6 \text{ V}$, $I_{\text{LX}} = -100 \text{ mA}$		0.19	Ω
t_{START}	Soft-start time	$V_{\text{IN}} = V_{\text{CE}} = 3.6 \text{ V}$		10		ms
I_{LXLIM}	LX current limit	$V_{\text{IN}} = V_{\text{CE}} = 3.6 \text{ V}$	300	580		mA
V_{UVLOF}	Undervoltage lockout (UVLO) threshold voltage	$V_{\text{IN}} = V_{\text{CE}}$, falling	1.40	1.50	1.65	V
V_{UVLOR}		$V_{\text{IN}} = V_{\text{CE}}$, rising	1.55	1.65	1.80	V

All test items listed under Electrical Characteristics are done under the pulse load condition ($T_j \approx T_a = 25^{\circ}\text{C}$).
Test circuit is operated with "Open Loop Control" ($\text{GND} = 0 \text{ V}$), unless otherwise specified.

⁽¹⁾ RP517xxx1D only

RP517x

No.EA-519-190808

Product-specific Electrical Characteristics

Product name	V _{OUT} [V]		
	Min.	Typ.	Max.
RP517x031x	0.282	0.30	0.318
RP517x041x	0.382	0.40	0.418
RP517x051x	0.482	0.50	0.518
RP517x061x	0.582	0.60	0.618
RP517x071x	0.682	0.70	0.718
RP517x081x	0.782	0.80	0.818
RP517x091x	0.882	0.90	0.918
RP517x101x	0.982	1.00	1.018
RP517x111x	1.082	1.10	1.118
RP517x121x	1.182	1.20	1.218

TYPICAL APPLICATION CIRCUIT

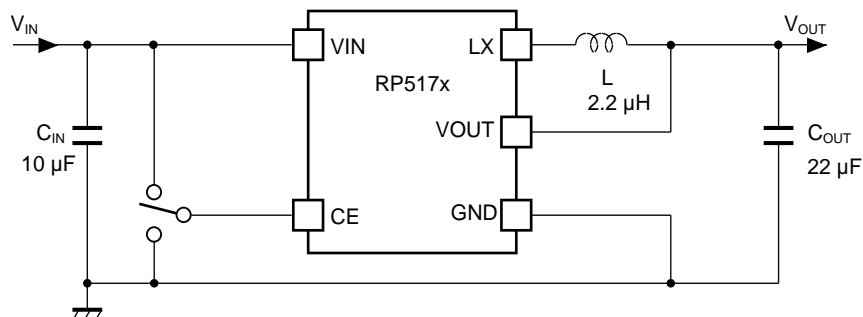

RP517x Typical Application Circuit

Precautions for Selecting External Components

- Using ceramic capacitors with low ESR (Equivalent Series Resistance) are recommended. Select capacitors with bias characteristics and input/output voltages taken into consideration.
- When a built-in Lx switch is turned off, a spike-like high voltage may be generated due to an inductor. C_{OUT} voltage resistance should be 1.5 times or more than the set output voltage.
- Select an inductor having small DC resistance, sufficient allowable current and less possibility of causing magnetic saturation.

TECHNICAL NOTES

The performance of a power source circuit using this device is highly dependent on the peripheral circuit. A peripheral component or the device mounted on PCB should not exceed a rated voltage, a rated current or a rated power. When designing a peripheral circuit, please be fully aware of the following points.

- When an intermediate voltage other than V_{IN} and GND is input to the CE pin, a supply current may be increased by a through current of a logic circuit in the IC. The CE pin is neither pulled up nor pulled down, therefore the operation is not stable at open.

THEORY OF OPERATION

Soft-start Time

Starting-up with CE Pin

The IC starts to operate when the CE pin voltage (V_{CE}) exceeds the threshold voltage. The threshold voltage is preset between CE “High” input voltage (V_{CEH}) and CE “Low” input voltage (V_{CEL}). After the start-up of the IC, soft-start circuit starts to operate. Then, after a certain period of time, the reference voltage (V_{REF}) in the IC gradually increases up to the specified value. Switching starts when V_{REF} reaches the preset voltage, and after that the output voltage rises as V_{REF} increases. Soft-start time (t_{START}) indicates the period from the time soft-start circuit gets activated to the time V_{REF} reaches the specified voltage. t_{START} is not always equal to the turn-on speed of the DC/DC converter. Note that the turn-on speed could be affected by the power supply capacity, the output current (I_{OUT}), the inductance and the output capacitor value (C_{OUT}).

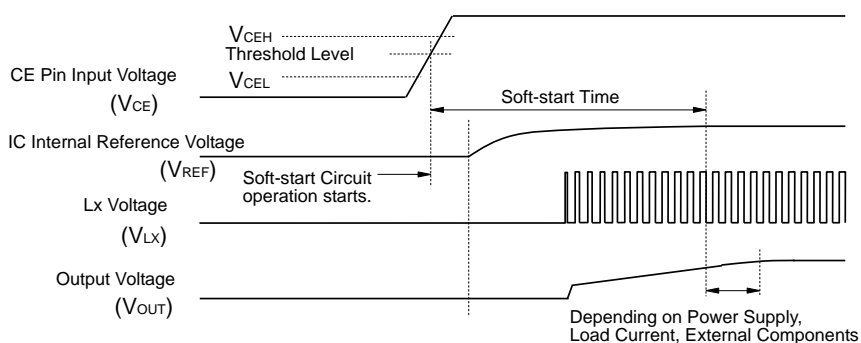

Timing Chart: Starting-up with CE Pin

Starting-up with Power Supply

After the power-on, when V_{IN} exceeds the UVLO release voltage (V_{UVLOR}), the IC starts to operate. Then, soft-start circuit starts to operate and after a certain period of time, V_{REF} gradually increases up to the specified value. Switching starts when V_{REF} reaches the preset voltage, and after that the output voltage rises as V_{REF} increases. The turn-on speed of V_{OUT} could be affected by following conditions:

1. The V_{IN} turn-on speed determined by the power supply to the IC and the C_{IN}
2. The output capacitor value (C_{OUT}) and the output current (I_{OUT})

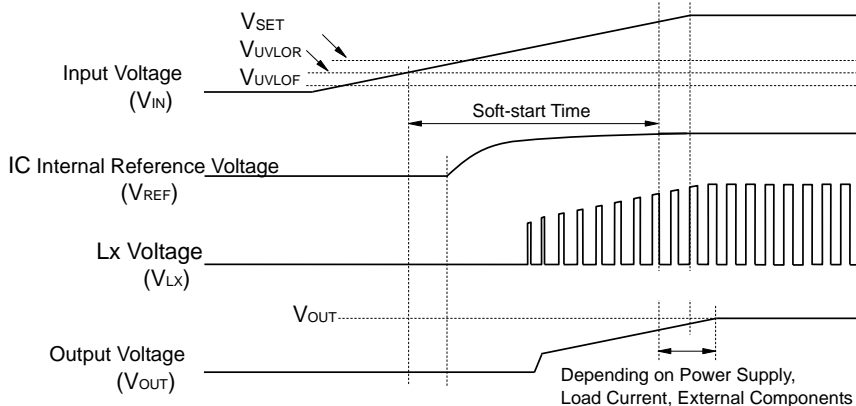

Timing Chart: Starting-up with Power Supply

Undervoltage Lockout (UVLO) Circuit

When V_{IN} becomes lower than V_{SET} , the buck DC/DC converter stops its switching operation and ON duty becomes 100%, then V_{OUT} gradually falls according to V_{IN} . When the V_{IN} drops below the UVLO detector threshold (V_{UVLOF}), the UVLO operates, V_{REF} stops, and PMOS and NMOS built-in switch transistors turn "OFF". As a result, V_{OUT} drops according to the C_{OUT} capacitance value and I_{OUT} . As for RP517xxx1D, the discharge transistor for C_{OUT} discharges after it turns on.

To restart the operation, V_{IN} needs to exceed V_{UVLOR} . The timing chart below shows the voltage shifts of V_{REF} , V_{LX} and V_{OUT} when V_{IN} value is varied.

Note: Falling edge (operating) and rising edge (releasing) waveforms of V_{OUT} could be affected by the initial voltage of C_{OUT} and the output current of V_{OUT} .

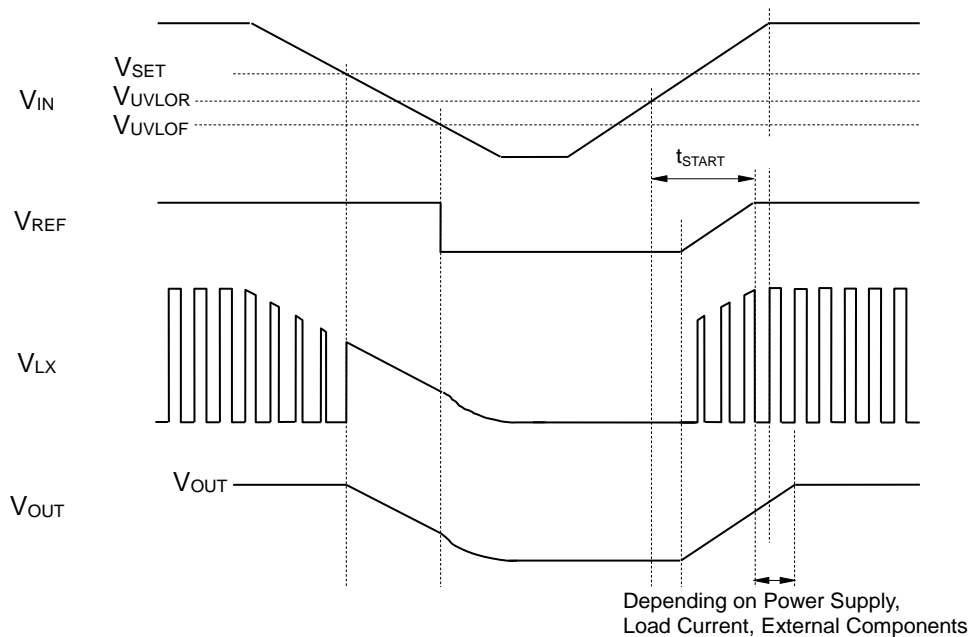
**Timing Chart with Variations in Input Voltage (V_{IN})**

Operation of Buck DC/DC Converter and Output Current

General operation of the buck DC/DC converter is shown in the following figures.

The buck DC/DC converter charges energy in the inductor while High Side transistor turns “ON”, and discharges the energy from the inductor when LX transistor turns “OFF”. This inductor reduces the energy loss to provide the lower output voltage (V_{OUT}) than the input voltage (V_{IN}).

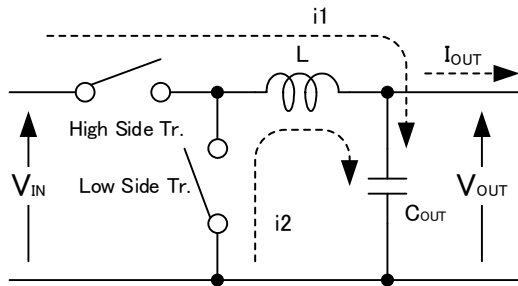

Basic Circuit

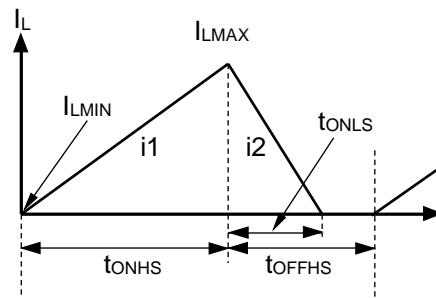

Inductor Current (I_L) flowing through Inductor (L)

- Step1.** When the High Side transistor turns “ON”, I_L ($i1$) flows through the inductor to charge C_{OUT} and provide I_{OUT} . At this moment, $i1$ increases from the minimum inductor current (I_{LMIN}) of 0 A to reach the maximum inductor current (I_{LMAX}) in proportion to the on-time period of High Side transistor (t_{ONHS}).
- Step2.** When High Side transistor turns “OFF”, the inductor turns Low Side transistor “ON” to maintain I_L at I_{LMAX} and I_L ($i2$) flows into L.
- Step3.** $I_L = i2$ decreases gradually and reaches I_{LMIN} after the open-time period of Low Side transistor and Low Side transistor (t_{ONLS}) turns “OFF”. This is called discontinuous current mode.
As to the continuous current mode, the output current (I_{OUT}) increases and the off-time period of High Side transistor (t_{OFFHS}) ends before I_L reaches I_{LMIN} . In the next cycle, High Side transistor turns “ON” and Low Side transistor turns “OFF”, then I_L increases from $I_L = I_{LMIN} > 0$.

When the buck DC/DC operation is constant, I_{LMIN} and I_{LMAX} during the open-time period of Low Side transistor (t_{ONHS}) would be same as during the off-time period of High Side transistor. The difference of the current between I_{LMAX} and I_{LMIN} represents ΔI as shown in the following equation 1.

$$\Delta I = I_{LMAX} - I_{LMIN} = V_{OUT} \times t_{ONLS} / L = (V_{IN} - V_{OUT}) \times t_{ONHS} / L \dots \dots \dots (1)$$

VFM Mode

The VFM (Variable Frequency Modulation) mode is adopted as a switching method to achieve a high efficiency under light load conditions. A switching frequency varies depending on values of input voltage (V_{IN}), output voltage (V_{OUT}), and output current (I_{OUT}). Check the actual characteristics to avoid the switching noise.

A switching starts when V_{OUT} drops below the lower-limit reference voltage (V_{REFL}). When V_{OUT} exceeds the upper-limit reference voltage (V_{REFH}), a constant voltage is output by a hysteresis control which stops the switching.

In order to operate within the rated characteristic of inductor and avoid the deteriorated band frequency of DC superimposed characteristics, when the inductor current (I_L) exceeds LX current limit (I_{LXLIM}), the operation shifts to off-cycle. And when I_L drops below the valley current limit (I_{LXVAL}), the operation shift to on-cycle.

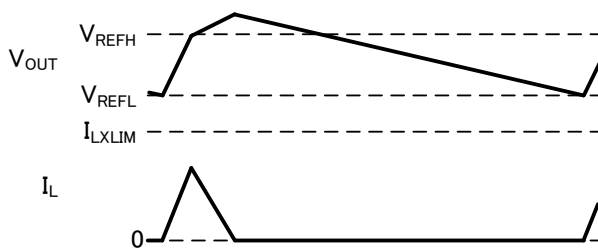
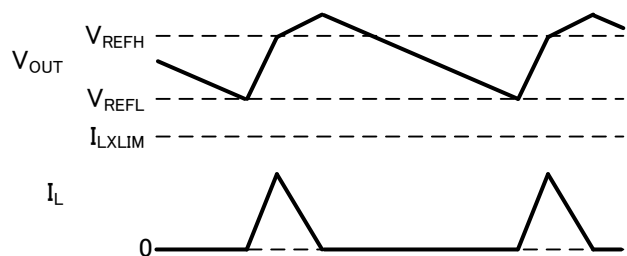
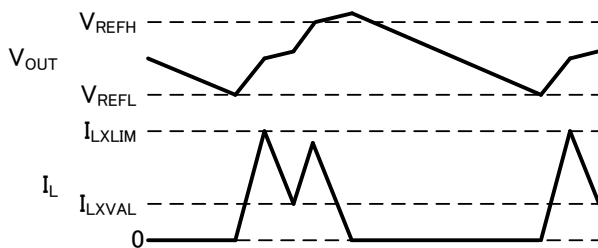
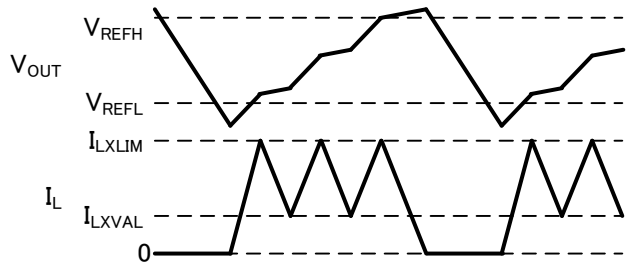
**No Load****Light Load****Medium Load****Heavy Load**

APPLICATION INFORMATION

Technical Notes of PCB Layout

The performance of a power source circuit using this device is highly dependent on a peripheral circuit. A peripheral component or the device mounted on PCB should not exceed a rated voltage, a rated current or a rated power. When designing a peripheral circuit, please be fully aware of the following points. Refer to *PCB Layout* below.

- External components must be connected as close as possible to the ICs and make wiring as short as possible. Especially, the capacitor connected in between VIN pin and GND pin must be wiring the shortest.
- If the impedance of power supply lines and GND lines is high, the internal voltage of the IC may shift by the switching current, and the operating may be unstable. Make the power supply and GND lines sufficient.
- A sufficient consideration is required due to a large switching current flows through power supply lines, GND lines, an inductor, LX and VOUT lines.
- The wiring between VOUT pin and inductor should be separated from the wiring connected to the load.

PCB Layout

RP517Zxx1x (WLCSP-8-P1)

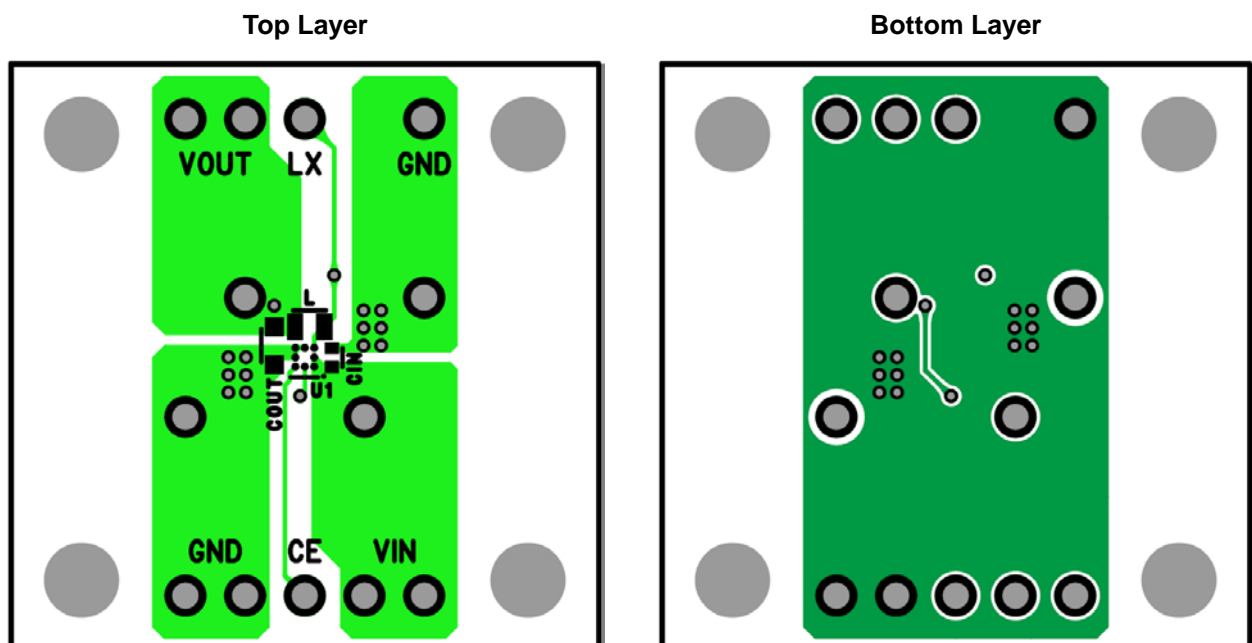

TYPICAL CHARACTERISTICS

Note: Typical Characteristics are intended to be used as reference data; they are not guaranteed.

1) Quiescent Current vs Temperature

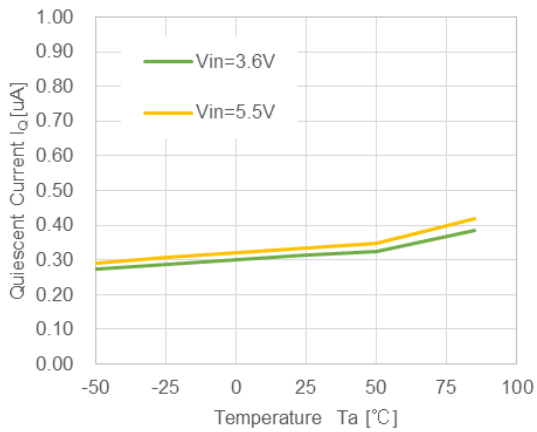

2) Standby Current vs Temperature

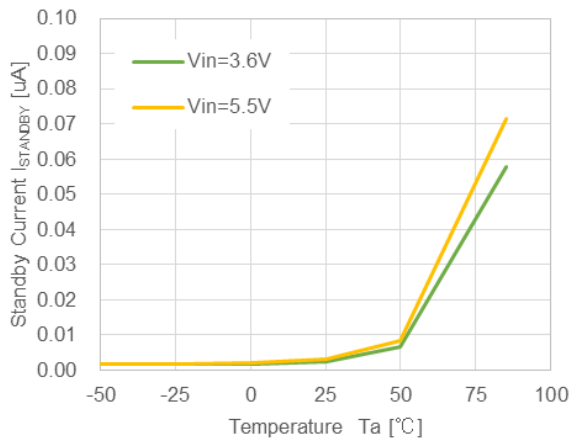

3) Output Voltage vs Temperature

RP517x051x, $V_{IN}=3.6V$

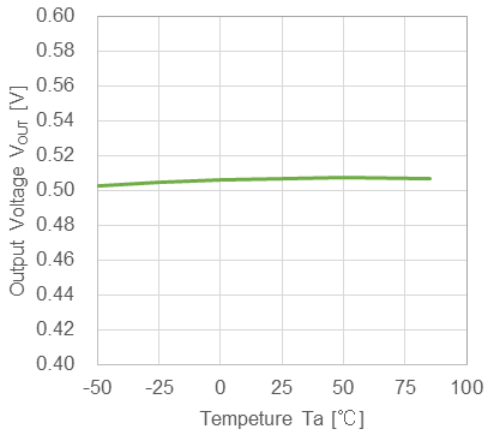

4) Efficiency vs Output Current

RP517x031x, Ta=25°C

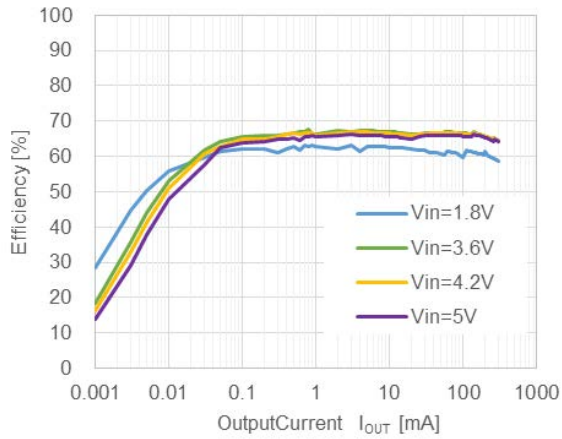

RP517x051x, Ta=25°C

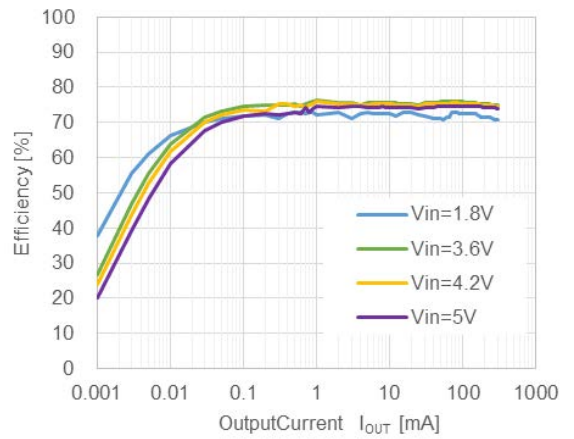

RP517x121x, Ta=25°C

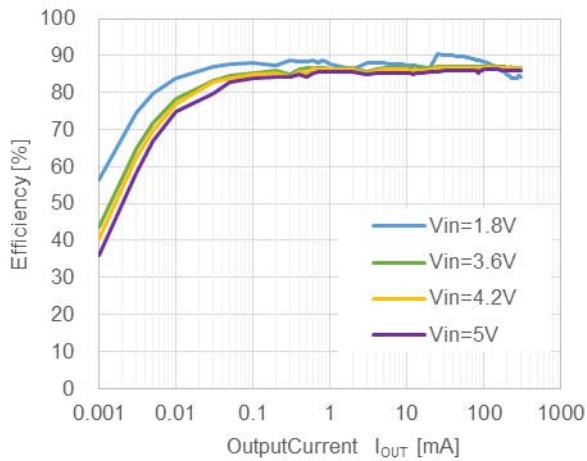

5) Output Voltage vs Output Current

RP517x031x, Ta=25°C

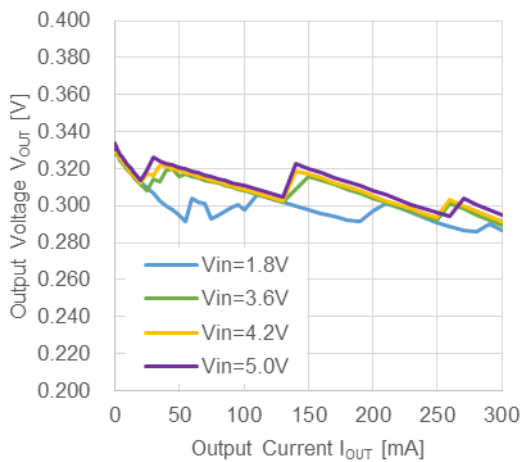

RP517x051x, Ta=25°C

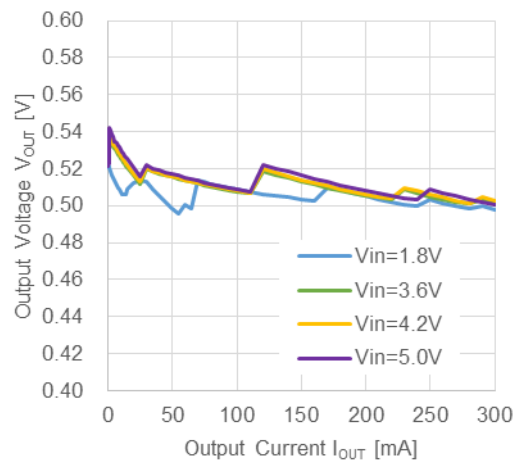

RP517x

No.EA-519-190808

RP517x121x, Ta=25°C

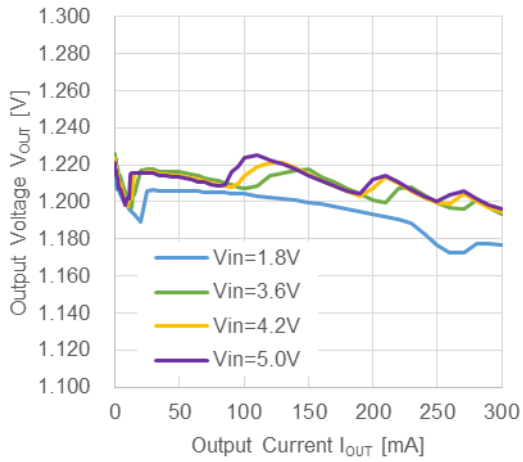

6) Ripple Voltage vs Output Current

RP517x031x, Ta=25°C

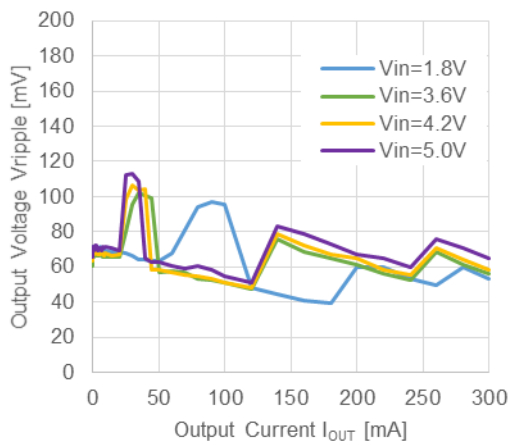

RP517x051x, Ta=25°C

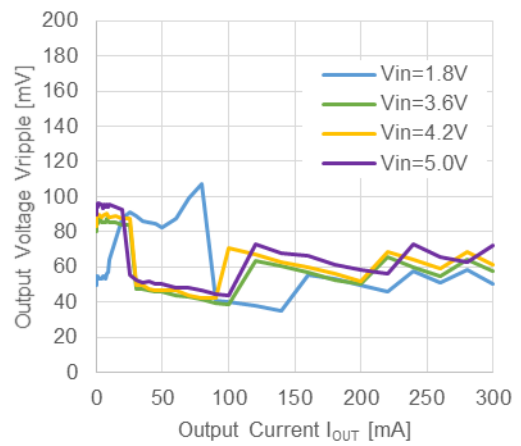

RP517x121x, Ta=25°C

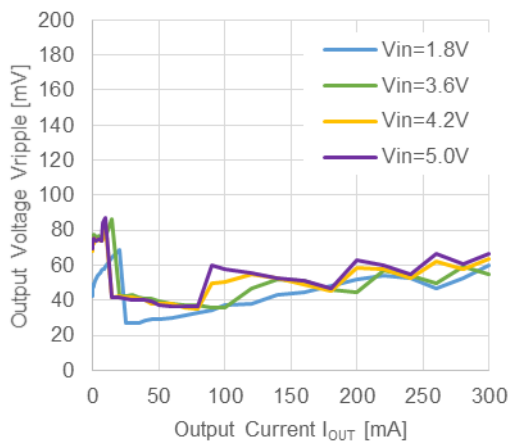

7) Switching Frequency vs Output Current

RP517x031x, Ta=25°C

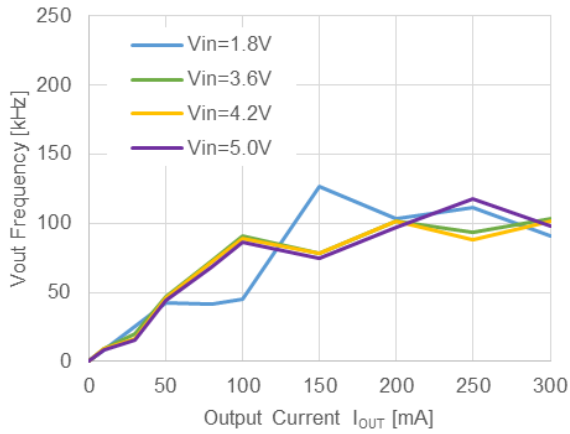

RP517x051x, Ta=25°C

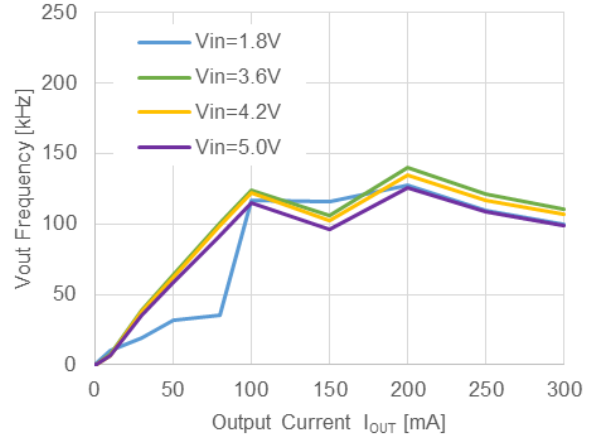

RP517x121x, Ta=25°C

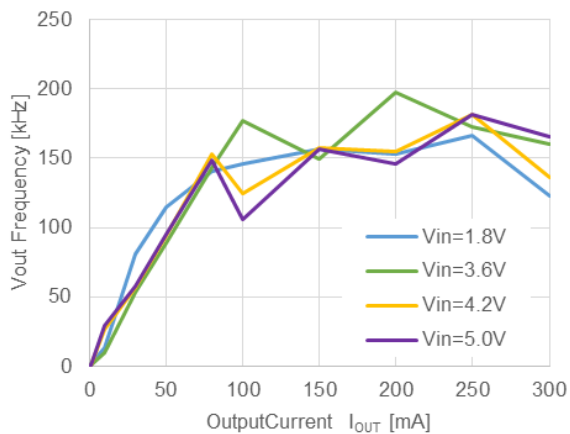

8) Load Transient Response

RP517x051x, $V_{IN}=3.6V$, Ta=25°C

$I_{OUT} = 10\mu A \rightarrow 100mA$

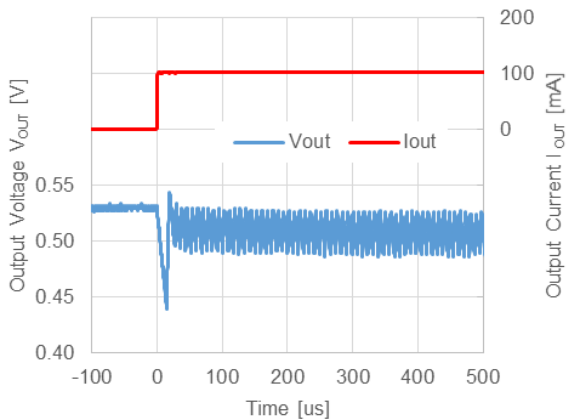

$I_{OUT} = 100mA \rightarrow 10\mu A$

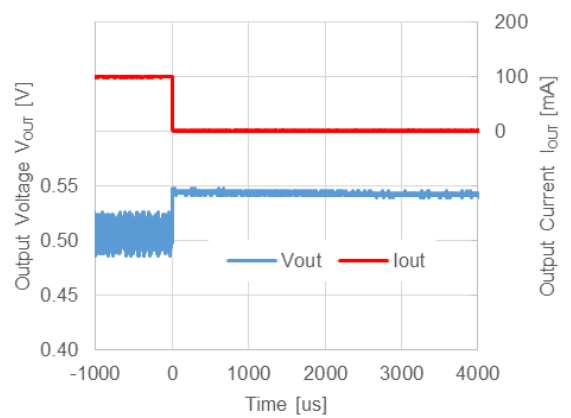

RP517x

No.EA-519-190808

9) Soft Start Time

RP517x051x, $T_a=25^\circ\text{C}$

$V_{IN}=V_{CE}=0\text{V}\rightarrow 3.6\text{V}$, $\Delta t=10\mu\text{s}$, $I_{OUT}=100\text{mA}$

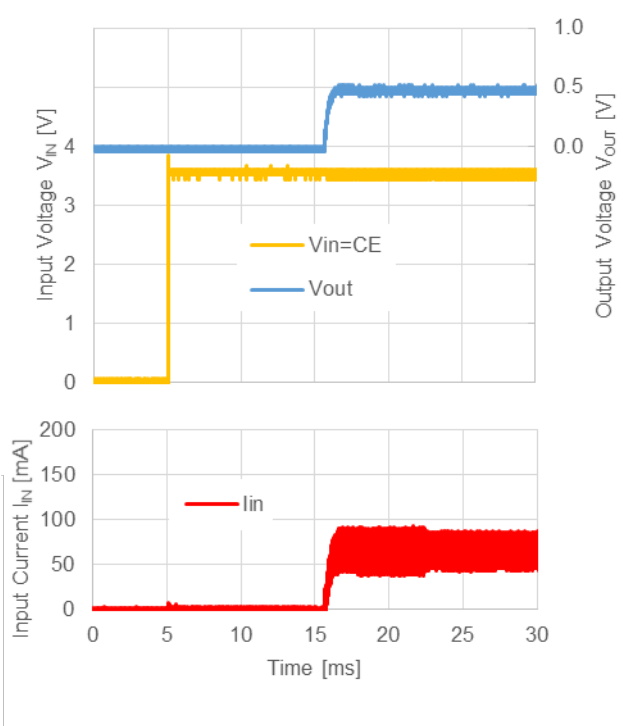

$V_{IN}=3.6\text{V}$, $V_{CE}=0\text{V}\rightarrow 3.6\text{V}$, $\Delta t=10\mu\text{s}$, $I_{OUT}=100\text{mA}$

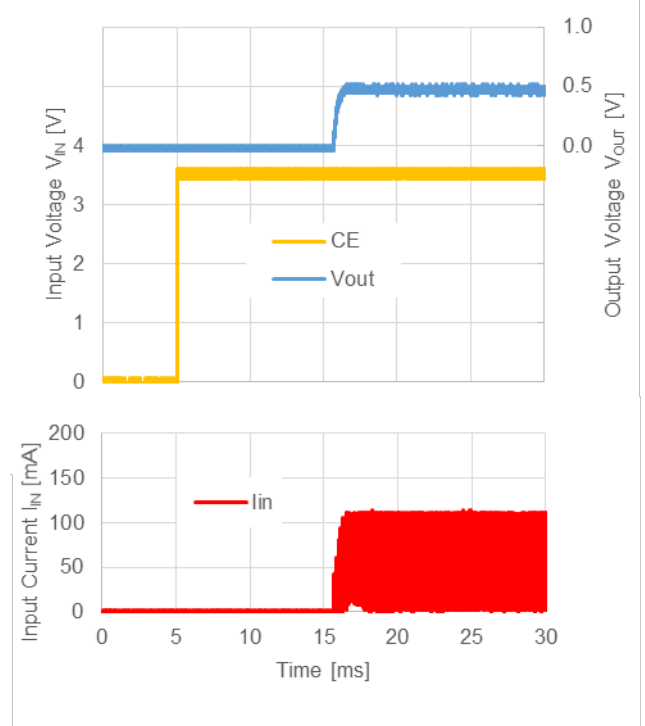

RP517x051x, $T_a=25^\circ\text{C}$

$V_{IN}=V_{CE}=0\text{V}\rightarrow 3.6\text{V}$, $\Delta t=10\mu\text{s}$, $I_{OUT}=0\text{mA}$

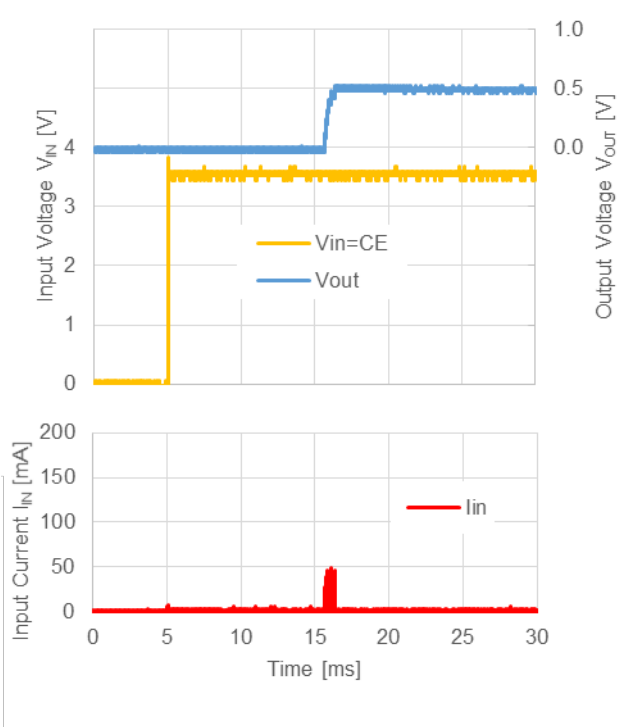

$V_{IN}=3.6\text{V}$, $V_{CE}=0\text{V}\rightarrow 3.6\text{V}$, $\Delta t=10\mu\text{s}$, $I_{OUT}=0\text{mA}$

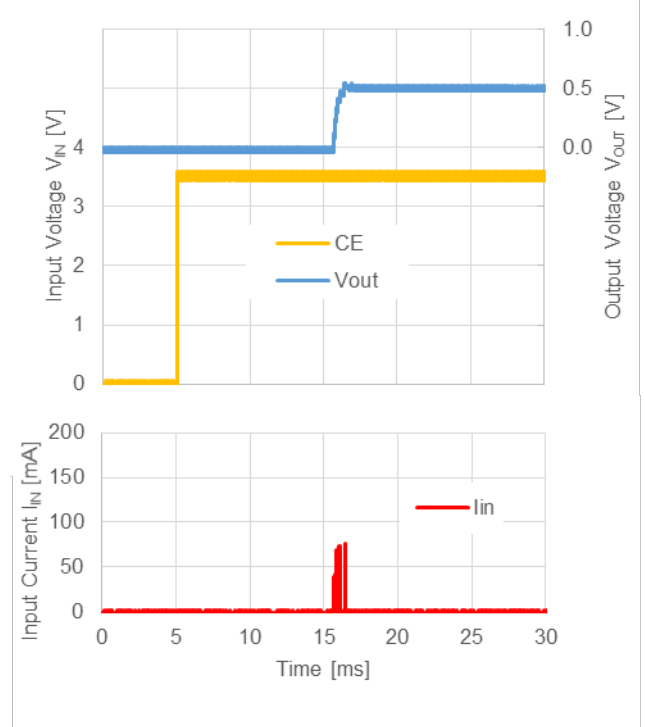

Test Circuit

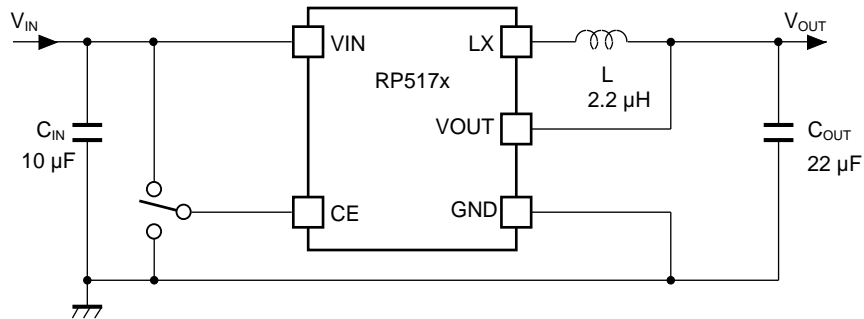

Test Circuit of Typical Characteristics

Measurement Components of Typical Characteristics

Symbol	Capacitance	Test item	Manufacture	Parts number
C _{IN}	10μF	All	Murata	GRM155R60J106ME0
C _{OUT}	22μF	All	TAIYO YUDEN	JMK107BBJ226MA-T
L	2.2μH	All	Murata	DFE201610P-2R2M

The power dissipation of the package is dependent on PCB material, layout, and environmental conditions. The following measurement conditions are based on JEDEC STD. 51-9.

Measurement Conditions

Item	Measurement Conditions
Environment	Mounting on Board (Wind Velocity = 0 m/s)
Board Material	Glass Cloth Epoxy Plastic (Four-Layer Board)
Board Dimensions	101.5 mm x 114.5 mm x 1.6 mm
Copper Ratio	Outer Layer (First Layer): 10% 50um Inner Layers (Second and Third Layers): 99.5 x 99.5mm 100% 70um Outer Layer (Fourth Layer): 10% 50um

Measurement Result

(Ta = 25°C, Tjmax = 125°C)

Item	Measurement Result
Power Dissipation	840 mW
Thermal Resistance (θ_{ja})	$\theta_{ja} = 119^{\circ}\text{C/W}$

θ_{ja} : Junction-to-Ambient Thermal Resistance

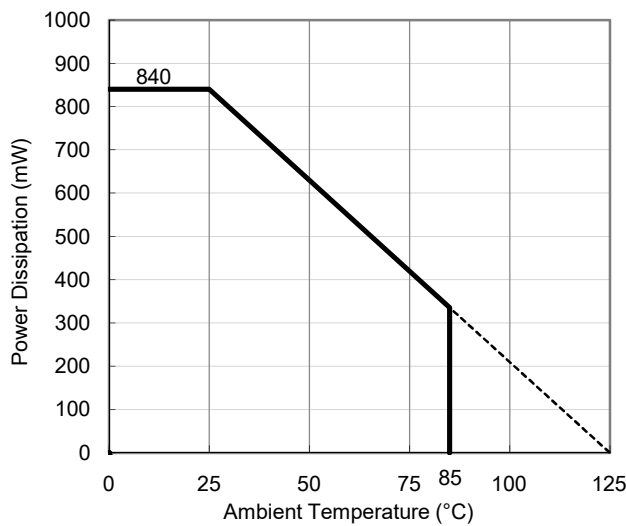

Power Dissipation vs. Ambient Temperature

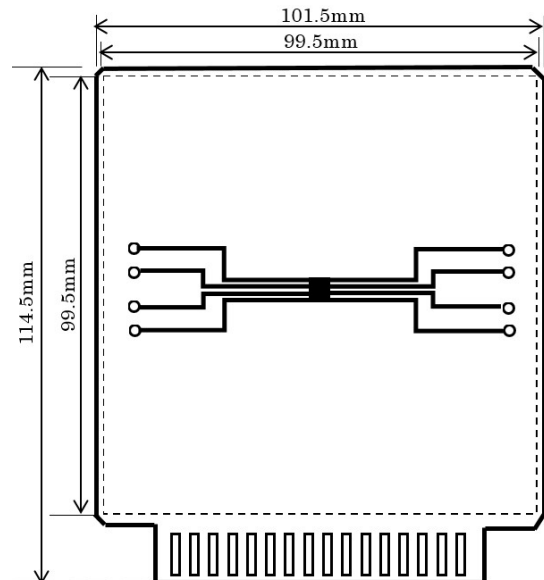

Measurement Board Pattern

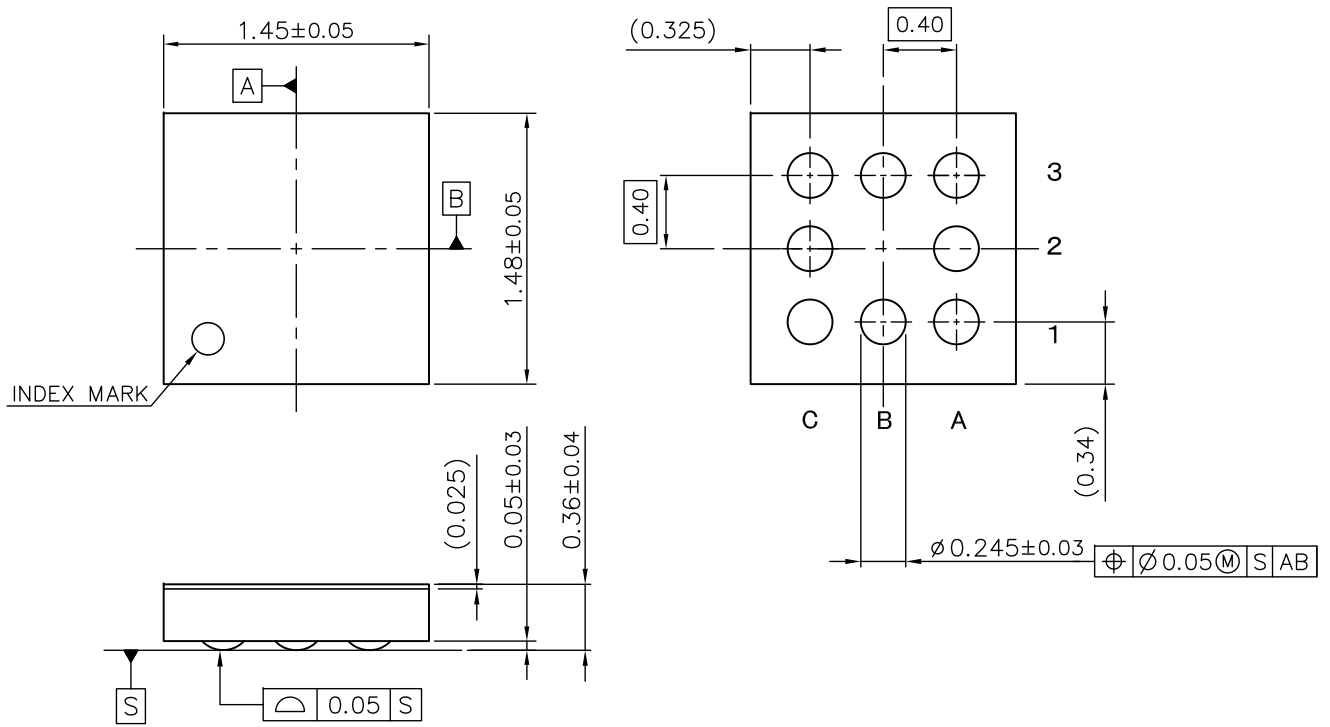

WLCSP-8-P1 Package Dimensions (Unit: mm)

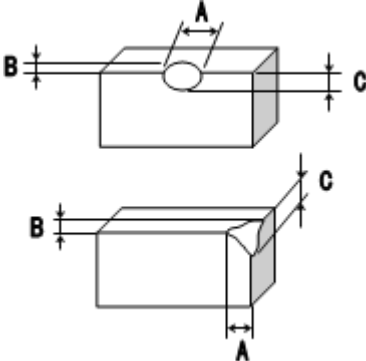
No.	Inspection Items	Inspection Criteria	Figure
1	Package chipping	<p>$A \geq 0.2\text{mm}$ is rejected $B \geq 0.2\text{mm}$ is rejected $C \geq 0.2\text{mm}$ is rejected And, Package chipping to Si surface and to bump is rejected.</p>	
2	Si surface chipping	<p>$A \geq 0.2\text{mm}$ is rejected $B \geq 0.2\text{mm}$ is rejected $C \geq 0.2\text{mm}$ is rejected But, even if $A \geq 0.2\text{mm}$, $B \leq 0.1\text{mm}$ is acceptable.</p>	
3	No bump	No bump is rejected.	
4	Marking miss	To reject incorrect marking, such as another product name marking or another lot No. marking.	
5	No marking	To reject no marking on the package.	
6	Reverse direction of marking	To reject reverse direction of marking character.	
7	Defective marking	To reject unreadable marking. (Microscope: X15/ White LED/ Viewed from vertical direction)	
8	Scratch	To reject unreadable marking character by scratch. (Microscope: X15/ White LED/ Viewed from vertical direction)	
9	Stain and Foreign material	To reject unreadable marking character by stain and foreign material. (Microscope: X15/ White LED/ Viewed from vertical direction)	

The power dissipation of the package is dependent on PCB material, layout, and environmental conditions. The following measurement conditions are based on JEDEC STD. 51-7.

Measurement Conditions

Item	Measurement Conditions
Environment	Mounting on Board (Wind Velocity = 0 m/s)
Board Material	Glass Cloth Epoxy Plastic (Four-Layer Board)
Board Dimensions	76.2 mm × 114.3 mm × 0.8 mm
Copper Ratio	Outer Layer (First Layer): Less than 95% of 50 mm Square Inner Layers (Second and Third Layers): Approx. 100% of 50 mm Square Outer Layer (Fourth Layer): Approx. 100% of 50 mm Square
Through-holes	φ 0.3 mm × 30 pcs

Measurement Result

(Ta = 25°C, Tjmax = 125°C)

Item	Measurement Result
Power Dissipation	2500 mW
Thermal Resistance (θ_{ja})	$\theta_{ja} = 39^{\circ}\text{C/W}$
Thermal Characterization Parameter (ψ_{jt})	$\psi_{jt} = 11^{\circ}\text{C/W}$

θ_{ja} : Junction-to-Ambient Thermal Resistance

ψ_{jt} : Junction-to-Top Thermal Characterization Parameter

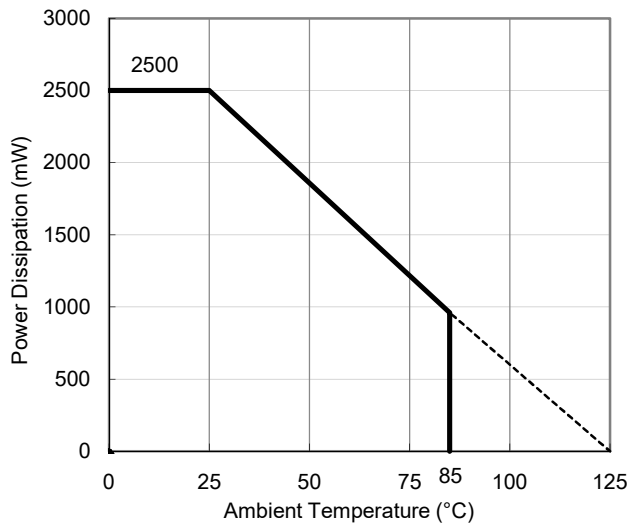

Power Dissipation vs. Ambient Temperature

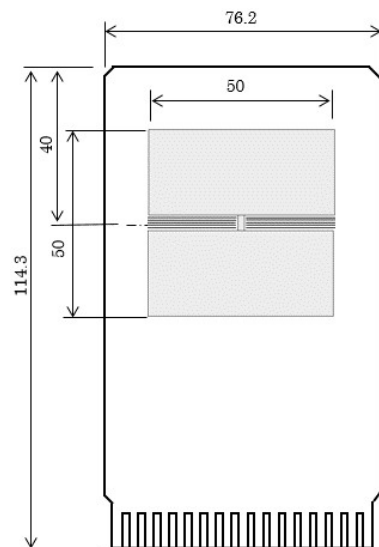

Measurement Board Pattern

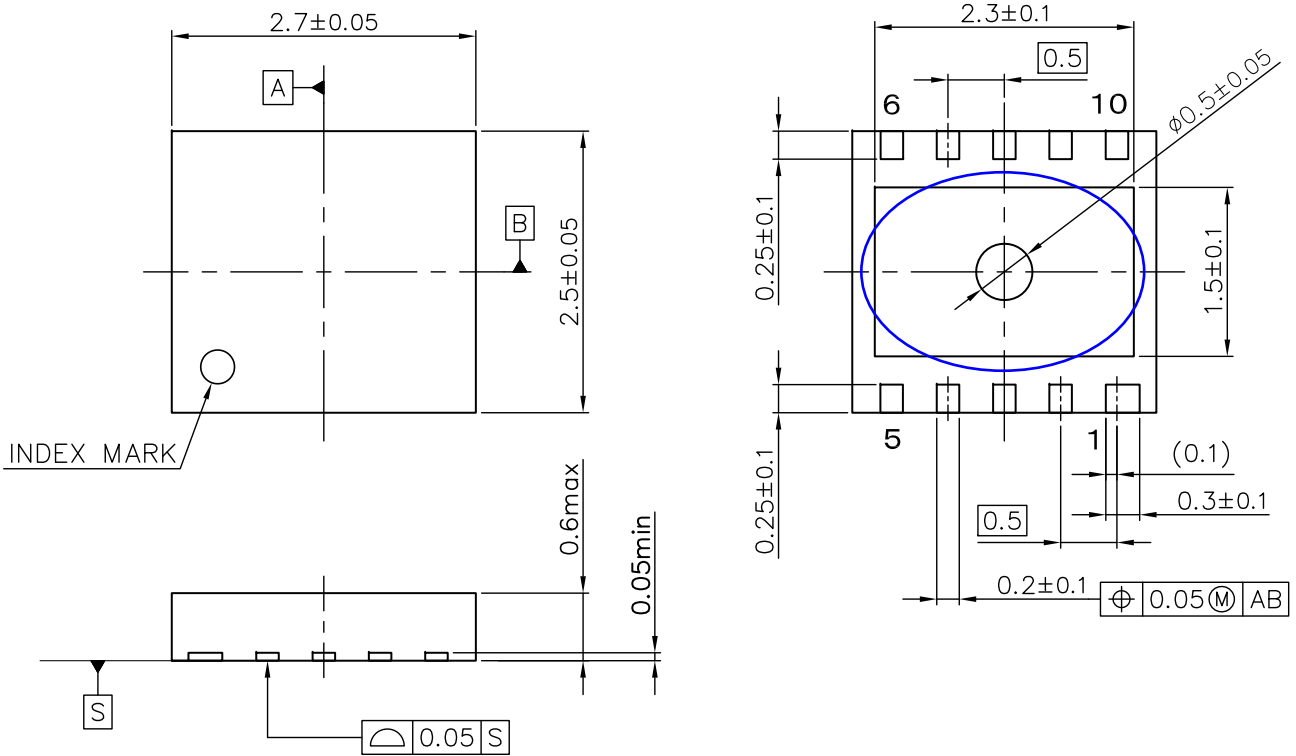

DFN(PLP)2527-10 Package Dimensions (mm)

* The tab on the bottom of the package shown by blue circle is a substrate potential (GND). It is recommended that this tab be connected to the ground plane on the board but it is possible to leave the tab floating.

The power dissipation of the package is dependent on PCB material, layout, and environmental conditions. The following measurement conditions are based on JEDEC STD. 51-7.

Measurement Conditions

Item	Measurement Conditions
Environment	Mounting on Board (Wind Velocity = 0 m/s)
Board Material	Glass Cloth Epoxy Plastic (Four-Layer Board)
Board Dimensions	76.2 mm × 114.3 mm × 0.8 mm
Copper Ratio	Outer Layer (First Layer): Less than 95% of 50 mm Square Inner Layers (Second and Third Layers): Approx. 100% of 50 mm Square Outer Layer (Fourth Layer): Approx. 100% of 50 mm Square
Through-holes	φ 0.3 mm × 13 pcs

Measurement Result

(Ta = 25°C, Tjmax = 125°C)

Item	Measurement Result
Power Dissipation	2600 mW
Thermal Resistance (θja)	θja = 38°C/W
Thermal Characterization Parameter (ψjt)	ψjt = 13°C/W

θja: Junction-to-Ambient Thermal Resistance

ψjt: Junction-to-Top Thermal Characterization Parameter

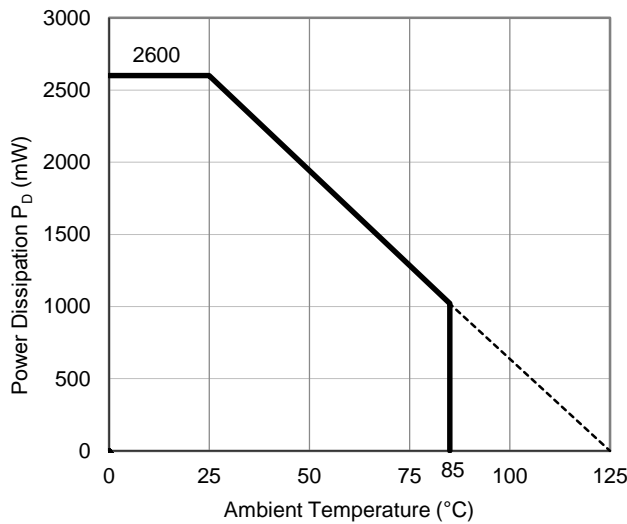

Power Dissipation vs. Ambient Temperature

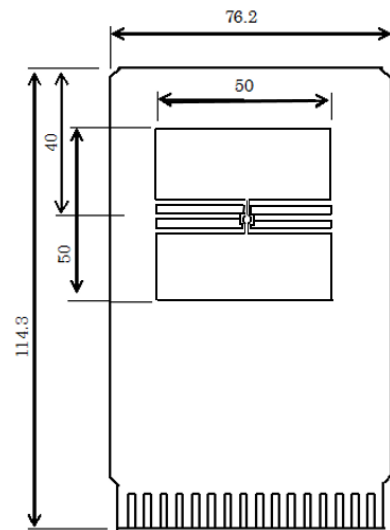

Measurement Board Pattern

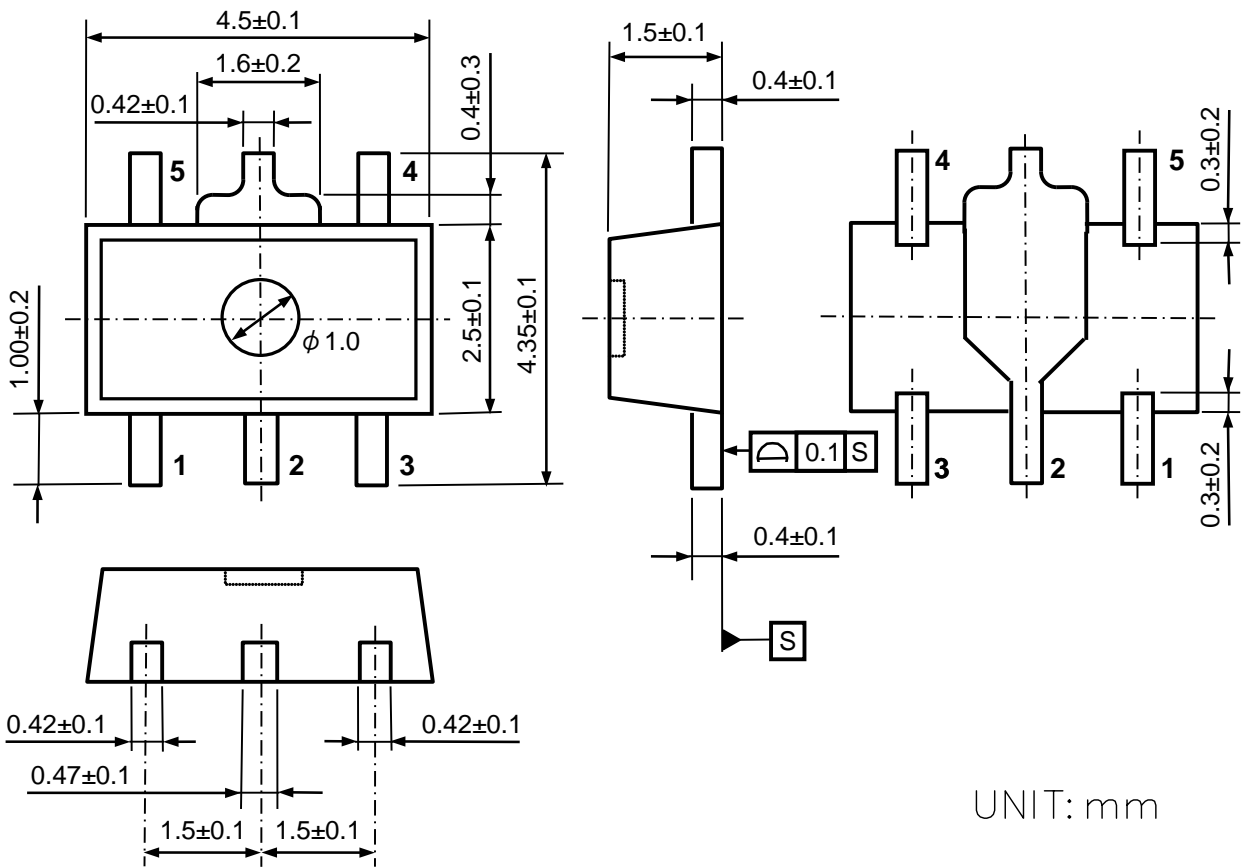

UNIT: mm

SOT-89-5 Package Dimensions



1. The products and the product specifications described in this document are subject to change or discontinuation of production without notice for reasons such as improvement. Therefore, before deciding to use the products, please refer to Ricoh sales representatives for the latest information thereon.
2. The materials in this document may not be copied or otherwise reproduced in whole or in part without prior written consent of Ricoh.
3. Please be sure to take any necessary formalities under relevant laws or regulations before exporting or otherwise taking out of your country the products or the technical information described herein.
4. The technical information described in this document shows typical characteristics of and example application circuits for the products. The release of such information is not to be construed as a warranty of or a grant of license under Ricoh's or any third party's intellectual property rights or any other rights.
5. The products listed in this document are intended and designed for use as general electronic components in standard applications (office equipment, telecommunication equipment, measuring instruments, consumer electronic products, amusement equipment etc.). Those customers intending to use a product in an application requiring extreme quality and reliability, for example, in a highly specific application where the failure or misoperation of the product could result in human injury or death (aircraft, spacevehicle, nuclear reactor control system, traffic control system, automotive and transportation equipment, combustion equipment, safety devices, life support system etc.) should first contact us.
6. We are making our continuous effort to improve the quality and reliability of our products, but semiconductor products are likely to fail with certain probability. In order to prevent any injury to persons or damages to property resulting from such failure, customers should be careful enough to incorporate safety measures in their design, such as redundancy feature, fire containment feature and fail-safe feature. We do not assume any liability or responsibility for any loss or damage arising from misuse or inappropriate use of the products.
7. Anti-radiation design is not implemented in the products described in this document.
8. The X-ray exposure can influence functions and characteristics of the products. Confirm the product functions and characteristics in the evaluation stage.
9. WLCSP products should be used in light shielded environments. The light exposure can influence functions and characteristics of the products under operation or storage.
10. There can be variation in the marking when different AOI (Automated Optical Inspection) equipment is used. In the case of recognizing the marking characteristic with AOI, please contact Ricoh sales or our distributor before attempting to use AOI.
11. Please contact Ricoh sales representatives should you have any questions or comments concerning the products or the technical information.



Ricoh is committed to reducing the environmental loading materials in electrical devices with a view to contributing to the protection of human health and the environment.

Ricoh has been providing RoHS compliant products since April 1, 2006 and Halogen-free products since April 1, 2012.

RICOH RICOH ELECTRONIC DEVICES CO., LTD.

Official website

<https://www.e-devices.ricoh.co.jp/en/>

Contact us

<https://www.e-devices.ricoh.co.jp/en/support/>

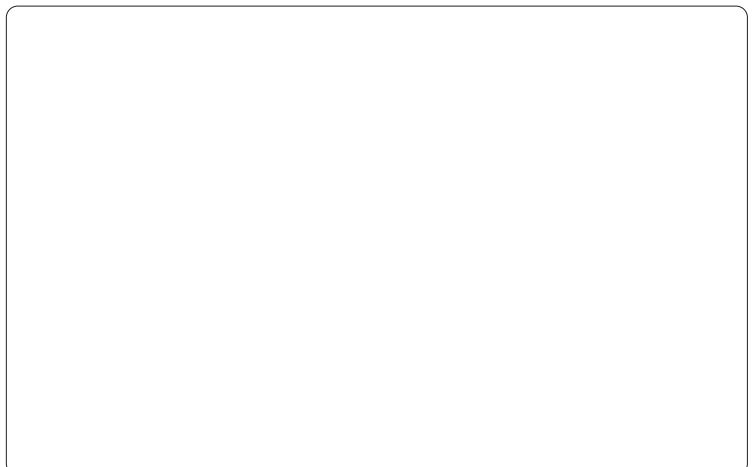

Mouser Electronics

Authorized Distributor

Click to View Pricing, Inventory, Delivery & Lifecycle Information:

[RicoH Electronics:](#)

[RP517Z121D-TR-F](#) [RP517Z101D-TR-F](#) [RP517K081D-TR](#)



Компания «ЭлектроПласт» предлагает заключение долгосрочных отношений при поставках импортных электронных компонентов на взаимовыгодных условиях!

Наши преимущества:

- Оперативные поставки широкого спектра электронных компонентов отечественного и импортного производства напрямую от производителей и с крупнейших мировых складов;
- Поставка более 17-ти миллионов наименований электронных компонентов;
- Поставка сложных, дефицитных, либо снятых с производства позиций;
- Оперативные сроки поставки под заказ (от 5 рабочих дней);
- Экспресс доставка в любую точку России;
- Техническая поддержка проекта, помощь в подборе аналогов, поставка прототипов;
- Система менеджмента качества сертифицирована по Международному стандарту ISO 9001;
- Лицензия ФСБ на осуществление работ с использованием сведений, составляющих государственную тайну;
- Поставка специализированных компонентов (Xilinx, Altera, Analog Devices, Intersil, Interpoint, Microsemi, Aeroflex, Peregrine, Syfer, Eurofarad, Texas Instrument, Miteq, Cobham, E2V, MA-COM, Hittite, Mini-Circuits, General Dynamics и др.);

Помимо этого, одним из направлений компании «ЭлектроПласт» является направление «Источники питания». Мы предлагаем Вам помощь Конструкторского отдела:

- Подбор оптимального решения, техническое обоснование при выборе компонента;
- Подбор аналогов;
- Консультации по применению компонента;
- Поставка образцов и прототипов;
- Техническая поддержка проекта;
- Защита от снятия компонента с производства.



Как с нами связаться

Телефон: 8 (812) 309 58 32 (многоканальный)

Факс: 8 (812) 320-02-42

Электронная почта: org@eplast1.ru

Адрес: 198099, г. Санкт-Петербург, ул. Калинина, дом 2, корпус 4, литера А.