

HB-2X2-ON

~15° + 50° oval beam

TECHNICAL SPECIFICATIONS:

Dimensions	50.0 mm
Height	10 mm
Fastening	screw
ROHS compliant	yes ⓘ

MATERIAL SPECIFICATIONS:

Component	Type	Material	Colour	Finish
HB-2X2-ON	Multi-lens	PMMA	clear	







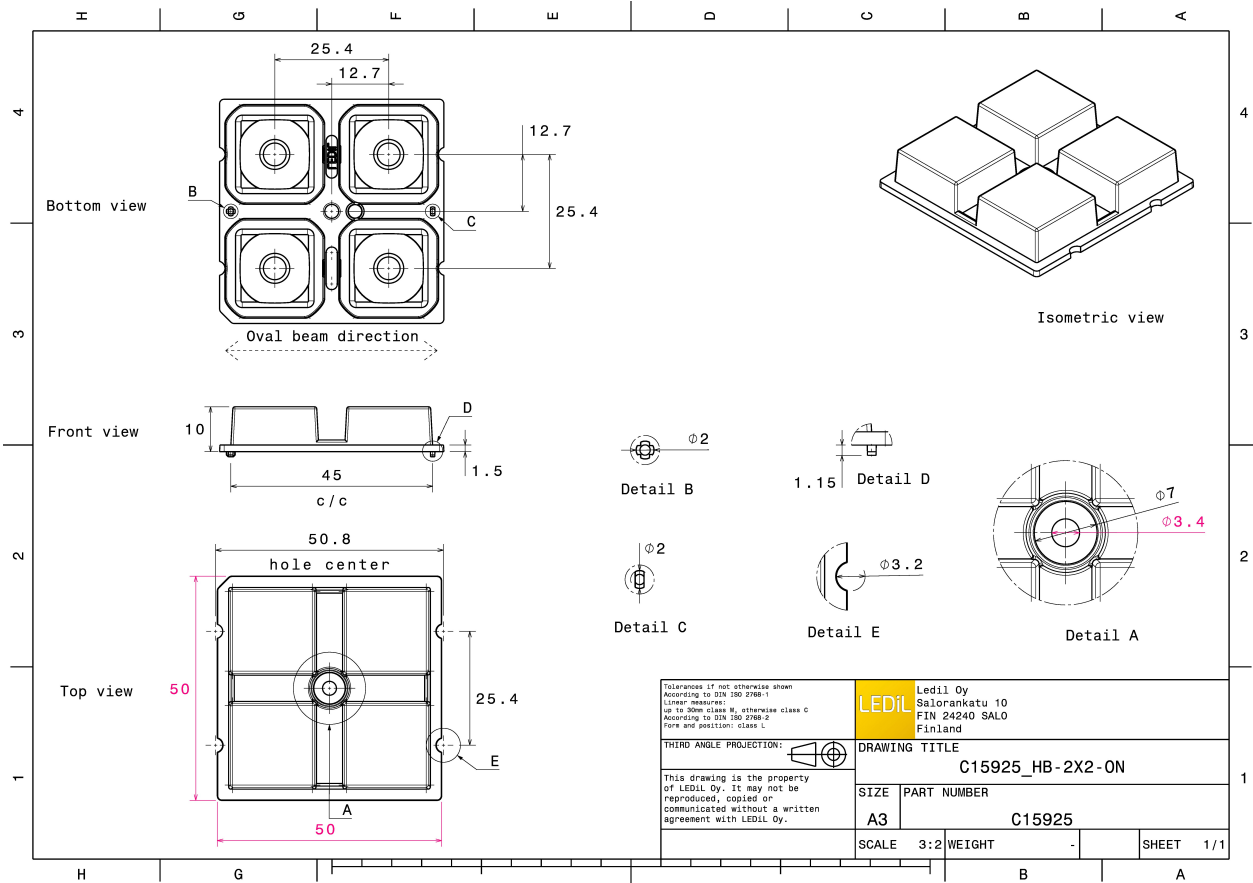

ORDERING INFORMATION:

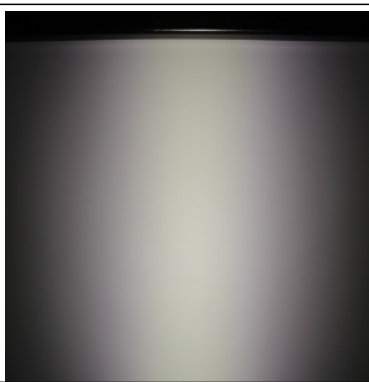
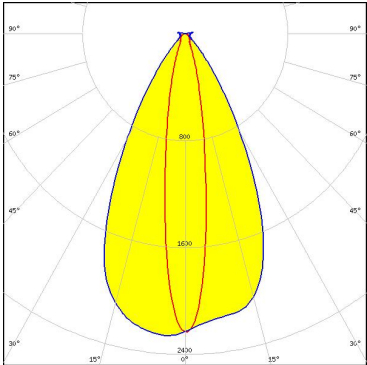
Component	Qty in box	MOQ	MPQ	Box weight (kg)
C15925_HB-2X2-ON » Box size: 480 x 280 x 300 mm	800	160	160	9.8

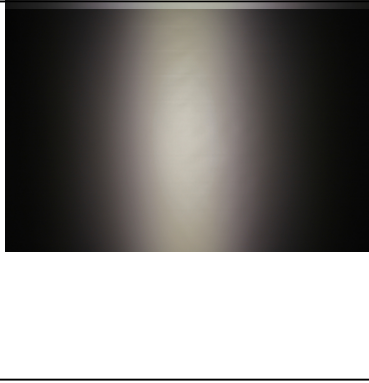
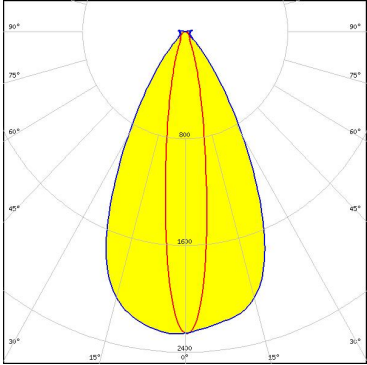

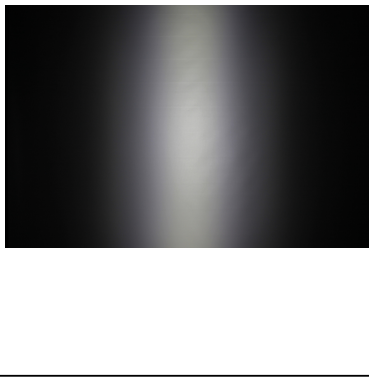
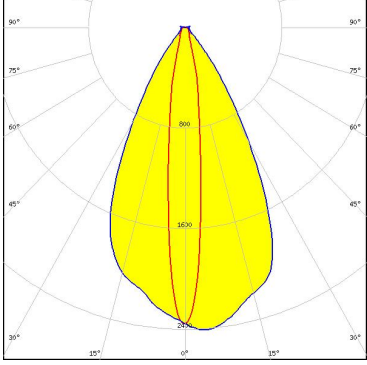
PHOTOMETRIC DATA (MEASURED):

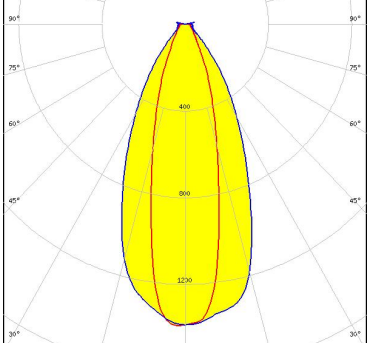
<p></p> <p>LED QUICK FLUX XTP 2x4 xxx LS G5 FWHM 16.0 + 55.0° Efficiency 93 % Peak intensity 2.3 cd/lm LEDs/each optic 1 Light colour White Required components:</p>		
<p></p> <p>LED QUICK FLUX XTP 2x6 xxx LS G5 FWHM 16.0 + 55.0° Efficiency 93 % Peak intensity 2.3 cd/lm LEDs/each optic 1 Light colour White Required components:</p>		
<p></p> <p>LED XD16 FWHM 13.0 + 55.0° Efficiency 89 % Peak intensity 2.4 cd/lm LEDs/each optic 1 Light colour White Required components:</p>		
<p></p> <p>LED XD16 FWHM 27.0 + 49.0° Efficiency 90 % Peak intensity 1.4 cd/lm LEDs/each optic 4 Light colour White Required components:</p>		

PHOTOMETRIC DATA (MEASURED):



LED XP-G2
 FWHM 14.0 + 55.0°
 Efficiency 89 %
 Peak intensity 2.7 cd/lm
 LEDs/each optic 1
 Light colour White
 Required components:

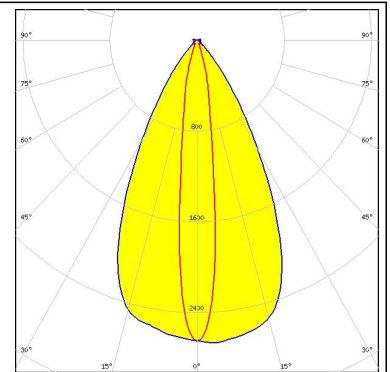

LED XP-L HI
 FWHM 14.0 + 55.0°
 Efficiency 91 %
 Peak intensity 2.6 cd/lm
 LEDs/each optic 1
 Light colour White
 Required components:

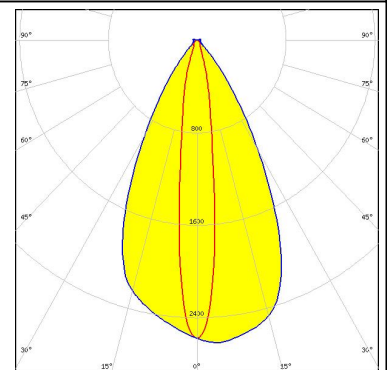
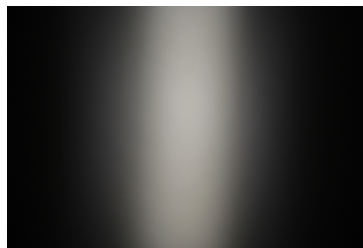

LED LUXEON V
 FWHM 22.0 + 51.0°
 Efficiency 92 %
 Peak intensity 1.8 cd/lm
 LEDs/each optic 1
 Light colour White
 Required components:

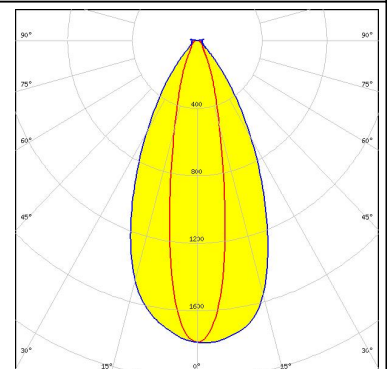
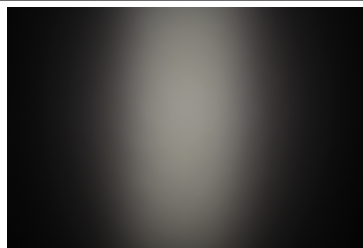

LED NVSW219F
 FWHM 17.0 + 53.0°
 Efficiency 93 %
 Peak intensity 2.4 cd/lm
 LEDs/each optic 1
 Light colour White
 Required components:

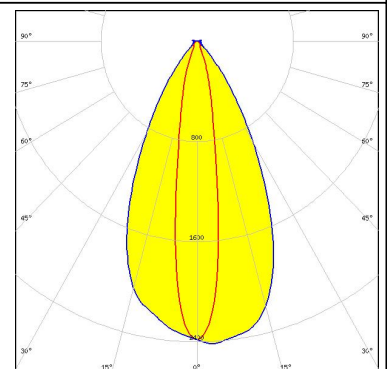
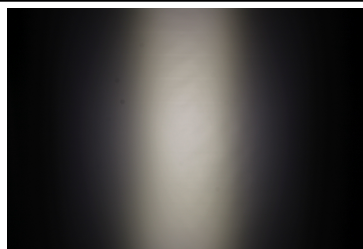

PHOTOMETRIC DATA (MEASURED):



LED NVSW319B
 FWHM 18.0 + 52.0°
 Efficiency 93 %
 Peak intensity 2.3 cd/lm
 LEDs/each optic 1
 Light colour White
 Required components:

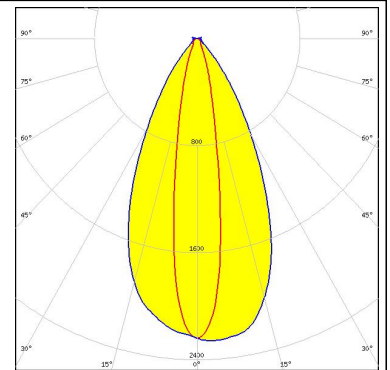
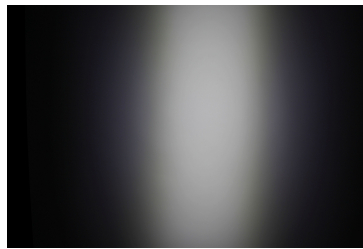

LED PrevaLED Brick HP 2x8
 FWHM 15.0 + 54.0°
 Efficiency 91 %
 Peak intensity 2.6 cd/lm
 LEDs/each optic 1
 Light colour White
 Required components:

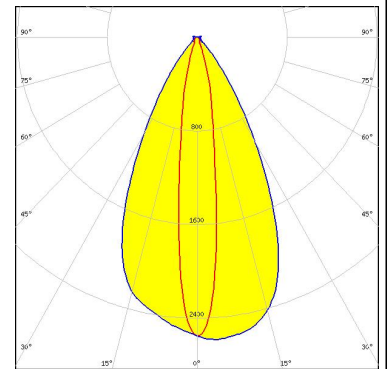
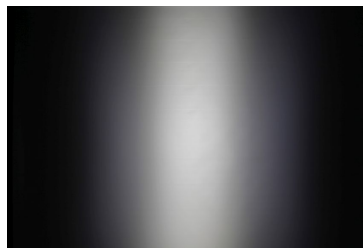



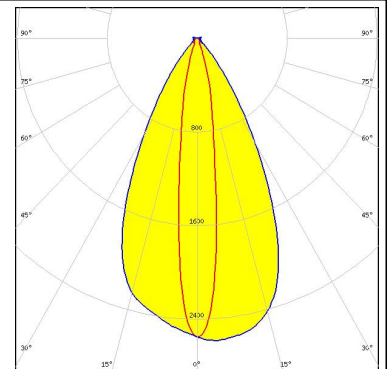
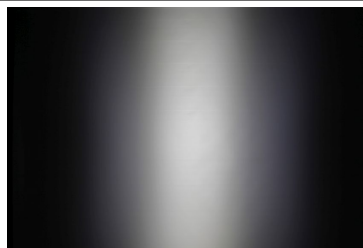

LED OSLOM Square CSSRM2/CSSRM3
 FWHM 15.0 + 54.0°
 Efficiency 91 %
 Peak intensity 2.6 cd/lm
 LEDs/each optic 1
 Light colour White
 Required components:

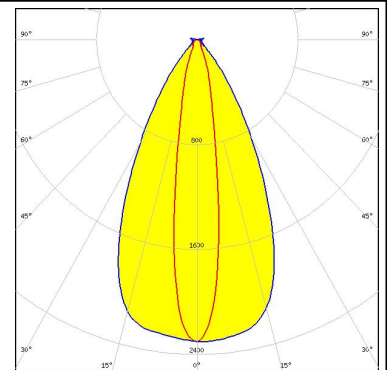
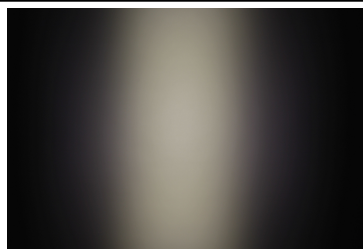

LED HiLOM RH16 (LH351C)
 FWHM 17.0 + 54.0°
 Efficiency 94 %
 Peak intensity 2.3 cd/lm
 LEDs/each optic 1
 Light colour White
 Required components:

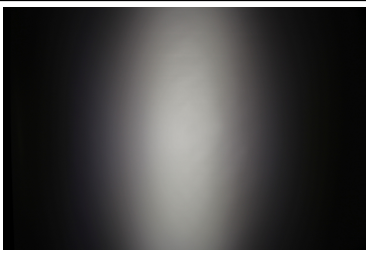
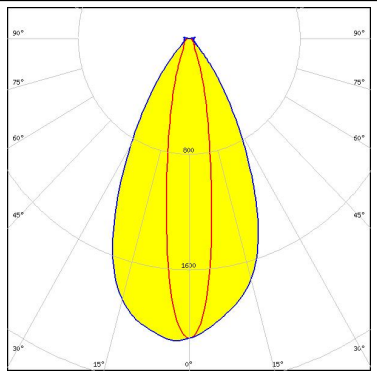

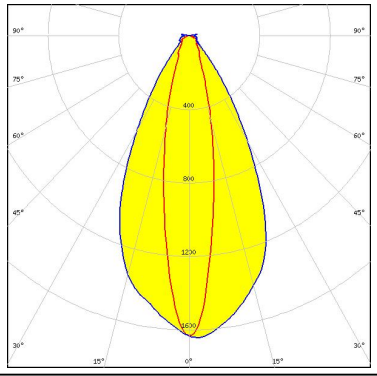
PHOTOMETRIC DATA (MEASURED):

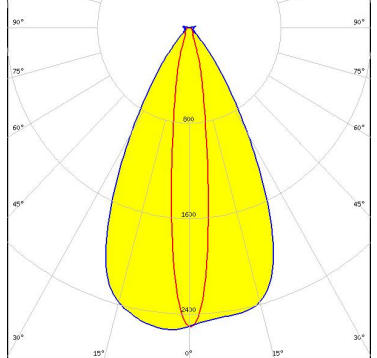
<p>SEOL SEOL SEMICONDUCTOR</p> <p>LED Z5M3 FWHM 18.0 + 53.0° Efficiency 93 % Peak intensity 2.1 cd/lm LEDs/each optic 1 Light colour White Required components:</p>		
<p>SEOL SEOL SEMICONDUCTOR</p> <p>LED Z8Y22 FWHM 20.0 + 53.0° Efficiency 91 % Peak intensity 1.6 cd/lm LEDs/each optic 1 Light colour White Required components:</p>		
<p>TRIDONIC</p> <p>LED RLE 2x4 2000lm HP EXC2 OTD FWHM 15.0 + 55.0° Efficiency 94 % Peak intensity 2.5 cd/lm LEDs/each optic 1 Light colour White Required components:</p>		
<p>TRIDONIC</p> <p>LED RLE 2x8 4000lm HP EXC2 OTD FWHM 15.0 + 55.0° Efficiency 94 % Peak intensity 2.5 cd/lm LEDs/each optic 1 Light colour White Required components:</p>		

PHOTOMETRIC DATA (SIMULATED):



LED XHP35 HI
 FWHM 16.0 + 50.0°
 Efficiency 90 %
 LEDs/each optic 1
 Light colour White
 Required components:

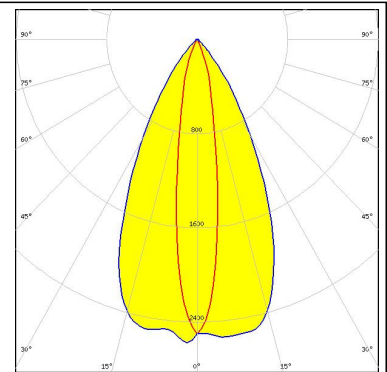

LED XP-E2
 FWHM 54.0 + 10.0°
 Efficiency 93 %
 Peak intensity 3.8 cd/lm
 LEDs/each optic 1
 Light colour White
 Required components:

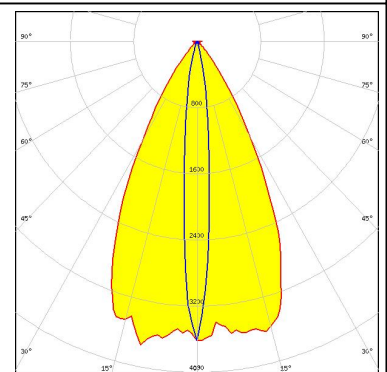

LED XP-E2
 FWHM 10.0 + 50.0°
 Efficiency 90 %
 LEDs/each optic 1
 Light colour White
 Required components:

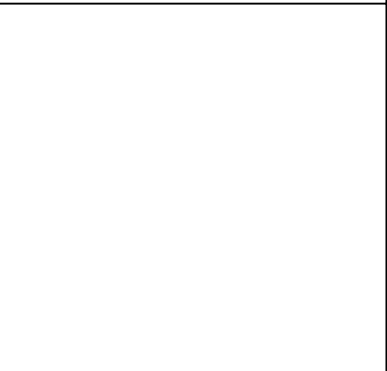

LED XP-G2 HE
 FWHM 18.0 + 51.0°
 Efficiency 90 %
 Peak intensity 2.4 cd/lm
 LEDs/each optic 1
 Light colour White
 Required components:

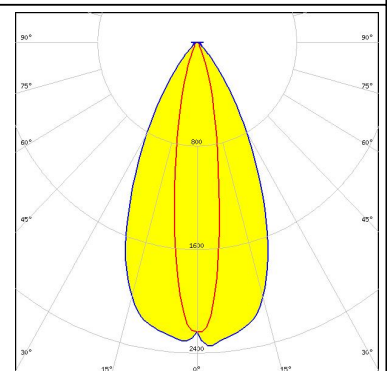

PHOTOMETRIC DATA (SIMULATED):



LED XP-G3
 FWHM 17.0 + 48.0°
 Efficiency 89 %
 LEDs/each optic 1
 Light colour White
 Required components:

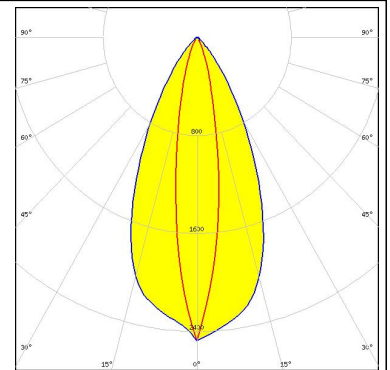

LED XP-L HD
 FWHM 18.0 + 50.0°
 Efficiency 88 %
 LEDs/each optic 1
 Light colour White
 Required components:

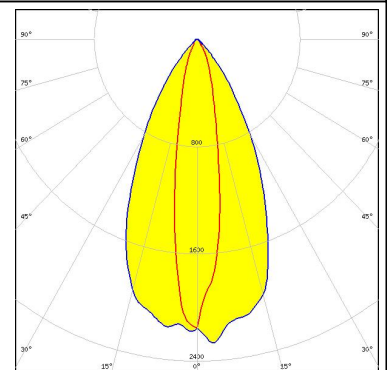

LED XT-E
 FWHM 14.0 + 55.0°
 Efficiency 91 %
 Peak intensity 2.9 cd/lm
 LEDs/each optic 1
 Light colour White
 Required components:

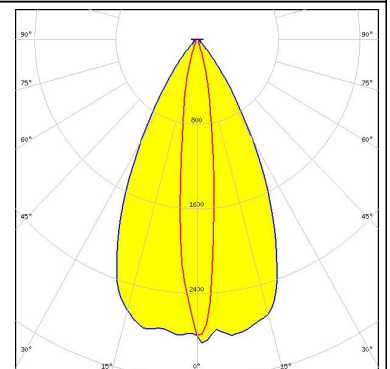

LED LUXEON 5050 Round LES
 FWHM 23.0 + 51.0°
 Efficiency 89 %
 Peak intensity 1.7 cd/lm
 LEDs/each optic 1
 Light colour White
 Required components:

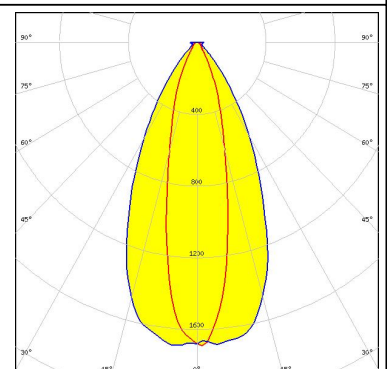

PHOTOMETRIC DATA (SIMULATED):

LUMILEDS

LED LUXEON C
 FWHM 12.0 + 54.0°
 Efficiency 91 %
 Peak intensity 3.4 cd/lm
 LEDs/each optic 1
 Light colour White
 Required components:

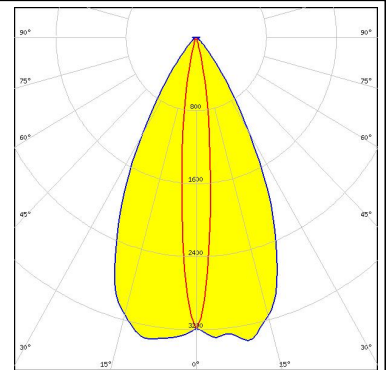

LUMILEDS

LED LUXEON TX
 FWHM 14.0 + 50.0°
 Efficiency 90 %
 LEDs/each optic 1
 Light colour White
 Required components:

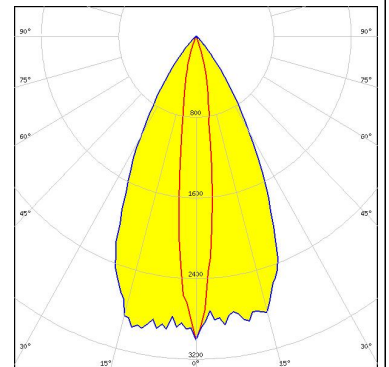

NICHIA

LED NV4WB35AM
 FWHM 20.0 + 50.0°
 Efficiency 90 %
 Peak intensity 2.1 cd/lm
 LEDs/each optic 1
 Light colour White
 Required components:

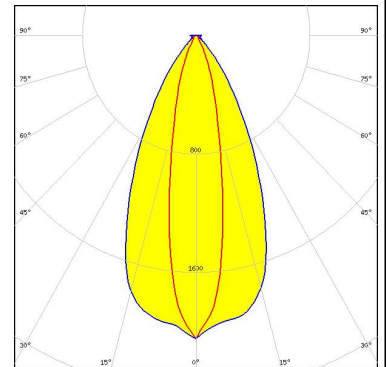

NICHIA

LED NVSxx19B/NVSxx19C
 FWHM 16.0 + 53.0°
 Efficiency 90 %
 Peak intensity 2.5 cd/lm
 LEDs/each optic 1
 Light colour White
 Required components:

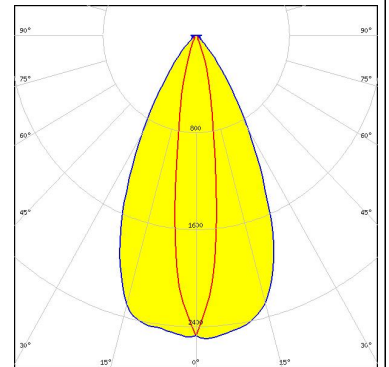

PHOTOMETRIC DATA (SIMULATED):

OSRAM
Opto Semiconductors

LED Duris S8
FWHM 29.0 + 49.0°
Efficiency 84 %
Peak intensity 1.4 cd/lm
LEDs/each optic 1
Light colour White
Required components:

Transparent protective cover

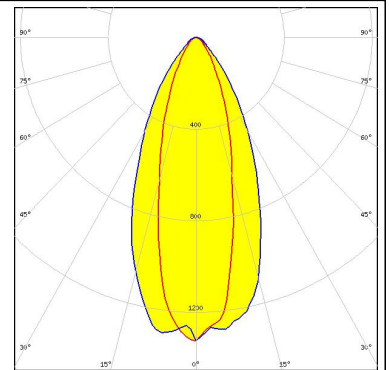

OSRAM
Opto Semiconductors

LED Duris S8
FWHM 26.0 + 49.0°
Efficiency 88 %
Peak intensity 1.6 cd/lm
LEDs/each optic 1
Light colour White
Required components:

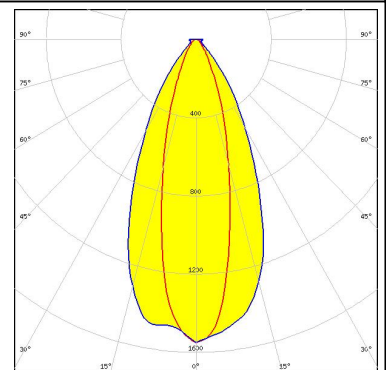

OSRAM
Opto Semiconductors

LED OSCONIQ P 3030
FWHM 10.0 + 56.0°
Efficiency 94 %
Peak intensity 3.5 cd/lm
LEDs/each optic 1
Light colour White
Required components:

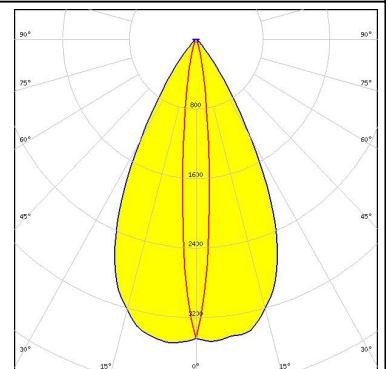

OSRAM
Opto Semiconductors

LED OSCONIQ P 3737 (2W version)
FWHM 13.0 + 56.0°
Efficiency 93 %
Peak intensity 2.9 cd/lm
LEDs/each optic 1
Light colour White
Required components:

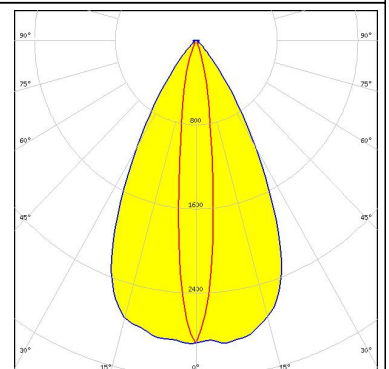

PHOTOMETRIC DATA (SIMULATED):

OSRAM
Opto Semiconductors

LED OSCONIQ P 3737 Flat
FWHM 16.0 + 54.0°
Efficiency 92 %
Peak intensity 2.6 cd/lm
LEDs/each optic 1
Light colour White
Required components:

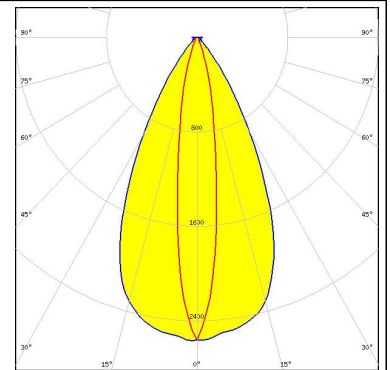

SEOUL
SEOUL SEMICONDUCTOR

LED SEOUL DC 5050 6V
FWHM 26.0 + 50.0°
Efficiency 90 %
Peak intensity 1.6 cd/lm
LEDs/each optic 1
Light colour White
Required components:

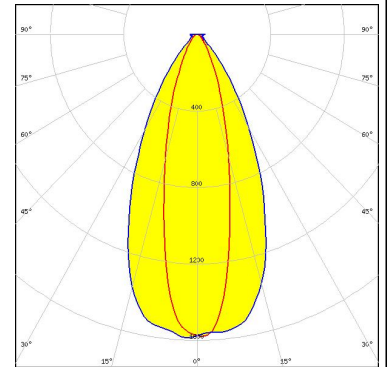

SEOUL
SEOUL SEMICONDUCTOR

LED Z8Y22T
FWHM 16.0 + 52.0°
Efficiency 90 %
Peak intensity 2.5 cd/lm
LEDs/each optic 1
Light colour White
Required components:

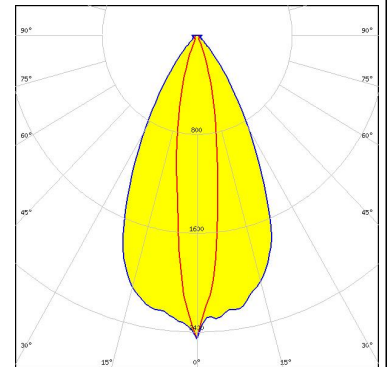

GENERAL INFORMATION:

NOTE: The typical beam angle will be changed by different color, chip size and chip position tolerance. The typical total beam angle is the full angle measured where the luminous intensity is half of the peak value.

MATERIALS:

As part of our continuous research and improvement processes, and to ensure the best possible quality and availability of our products, LEDiL reserves the right to change material grades without notice.

PRODUCT DATA USER AGREEMENT AND DISCLAIMER:

The measured data in the provided downloadable LEDiL Product Datasheets and Mechanical 2D-Drawings is rounded and provided as reference for planning. LEDiL Oy's optical specifications have been verified by conducting performance testing of the products in accordance with the company's quality system. The reported data are averaged results of multiple measurements with typical variation. LEDiL Oy reserves the right to without prior notification make changes and improvements to its products.

LEDiL Oy assumes neither warranty, nor guarantee nor any other liability of any kind for the contents and correctness of the provided data. The provided data has been generated with highest diligence but the provided data may in reality not represent the complete possible variation range of all intrinsic parameters. Therefore, in certain cases a deviation from the provided data could occur.

LEDiL Oy reserves the right to undertake technical changes of its products without further notification which could lead to changes in the provided data. LEDiL Oy assumes no liability of any kind for the possible deviation from any provided data or any other damage resulting from the usage of the provided data.

The user agrees to this disclaimer and user agreement with the download or usage of the provided files.

LEDiL Oy

Joensuunkatu 13
FI-24240 SALO
Finland

LEDiL Inc.

228 West Page Street
Suite D
Sycamore IL 60178
USA

Local sales and technical support

[www.ledil.com/
where_to_buy](http://www.ledil.com/where_to_buy)

Shipping locations

Salo, Finland
Hong Kong, China

Distribution Partners

[www.ledil.com/
where_to_buy](http://www.ledil.com/where_to_buy)



Компания «ЭлектроПласт» предлагает заключение долгосрочных отношений при поставках импортных электронных компонентов на взаимовыгодных условиях!

Наши преимущества:

- Оперативные поставки широкого спектра электронных компонентов отечественного и импортного производства напрямую от производителей и с крупнейших мировых складов;
- Поставка более 17-ти миллионов наименований электронных компонентов;
- Поставка сложных, дефицитных, либо снятых с производства позиций;
- Оперативные сроки поставки под заказ (от 5 рабочих дней);
- Экспресс доставка в любую точку России;
- Техническая поддержка проекта, помощь в подборе аналогов, поставка прототипов;
- Система менеджмента качества сертифицирована по Международному стандарту ISO 9001;
- Лицензия ФСБ на осуществление работ с использованием сведений, составляющих государственную тайну;
- Поставка специализированных компонентов (Xilinx, Altera, Analog Devices, Intersil, Interpoint, Microsemi, Aeroflex, Peregrine, Syfer, Eurofarad, Texas Instrument, Miteq, Cobham, E2V, MA-COM, Hittite, Mini-Circuits, General Dynamics и др.);

Помимо этого, одним из направлений компании «ЭлектроПласт» является направление «Источники питания». Мы предлагаем Вам помощь Конструкторского отдела:

- Подбор оптимального решения, техническое обоснование при выборе компонента;
- Подбор аналогов;
- Консультации по применению компонента;
- Поставка образцов и прототипов;
- Техническая поддержка проекта;
- Защита от снятия компонента с производства.



Как с нами связаться

Телефон: 8 (812) 309 58 32 (многоканальный)

Факс: 8 (812) 320-02-42

Электронная почта: org@eplast1.ru

Адрес: 198099, г. Санкт-Петербург, ул. Калинина, дом 2, корпус 4, литера А.