

Features

- Lead Free Finish/RoHS Compliant ("P" Suffix Designates RoHS Compliant. See Ordering Information)
- Epoxy Meets UL 94 V-0 Flammability Rating
- Moisture Sensitivity Level 1
- Low Diode Capacitance
- Low Diode Forward Resistance

Maximum Ratings

- Operating Junction Temperature Range: -65°C to +150°C
- Storage Temperature Range: -65°C to +150°C
- Thermal Resistance: 500°C/W Junction to Ambient

| Parameter | Symbol | Limits | Unit |
|--|--------|--------|------|
| Continuous Reverse Voltage | V_R | 175 | V |
| Forward Current | I_F | 100 | mA |
| Power Dissipation ($T_A=90^\circ\text{C}$) | P_D | 250 | mW |

| MCC Part Number | Device Marking |
|-----------------|----------------|
| BAP64-04 | 4K |
| BAP64-05 | 5K |
| BAP64-06 | 6K |

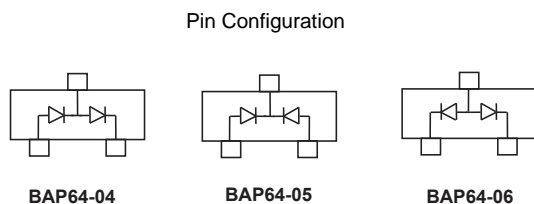

General Purpose Pin Diodes 250mW

SOT-23

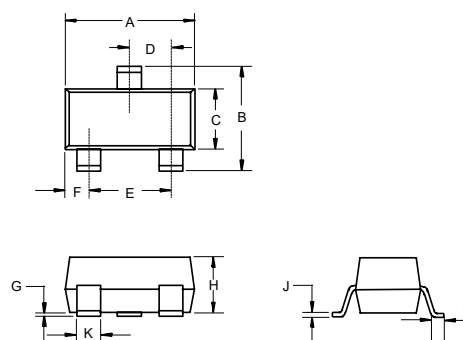

| DIM | INCHES | | MM | | NOTE |
|-----|--------|-------|------|------|------|
| | MIN | MAX | MIN | MAX | |
| A | 0.110 | 0.120 | 2.80 | 3.04 | |
| B | 0.083 | 0.104 | 2.10 | 2.64 | |
| C | 0.047 | 0.055 | 1.20 | 1.40 | |
| D | 0.034 | 0.041 | 0.85 | 1.05 | |
| E | 0.067 | 0.083 | 1.70 | 2.10 | |
| F | 0.018 | 0.024 | 0.45 | 0.60 | |
| G | 0.0004 | 0.006 | 0.01 | 0.15 | |
| H | 0.035 | 0.043 | 0.90 | 1.10 | |
| J | 0.003 | 0.007 | 0.08 | 0.18 | |
| K | 0.012 | 0.020 | 0.30 | 0.51 | |
| L | 0.007 | 0.020 | 0.20 | 0.50 | |

Suggested Solder Pad Layout

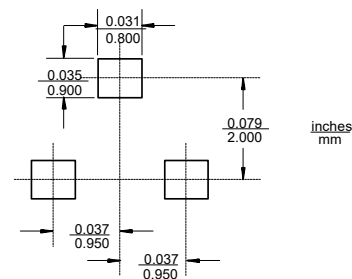

Electrical Characteristics @ 25°C Unless Otherwise Specified

| Parameter | Symbol | Min. | Typ | Max. | Conditions |
|---------------------------------|----------|------|--------------|---------------------------|---|
| Reverse Voltage Leakage Current | I_R | | | 10 μ A 1.0 μ A | $V_R=175V$ $V_R=20V$ |
| Forward Voltage | V_F | | | 1.1V | $I_F=50mA$ |
| Diode Capacitance | C_{d1} | | 0.52pF | | $V_R=0V, f=1MHz$ |
| | C_{d2} | | 0.37pF | 0.5pF | $V_R=1V, f=1MHz$ |
| | C_{d3} | | 0.23pF | 0.35pF | $V_R=20V, f=1MHz$ |
| Diode Forward Resistance | R_{D1} | | 20 Ω | 40 Ω | $I_F=0.5mA, f=100MHz$ |
| | R_{D2} | | 10 Ω | 20 Ω | $I_F=1.0mA, f=100MHz$ |
| | R_{D3} | | 2.0 Ω | 3.8 Ω | $I_F=10mA, f=100MHz$ |
| | R_{D4} | | 0.7 Ω | 1.35 Ω | $I_F=100mA, f=100MHz$ |
| Charge carrier life time | T_L | | 1.55 μ S | | When switched from $I_F=10mA$ to $I_R=6mA$; $R_L=100\Omega$; measured at $I_R=3mA$ |
| Series inductance | L_S | | 1.4nH | | $I_F=100mA, f=100MHz$ |

Curve Characteristics

Fig. 1 - Forward Characteristics

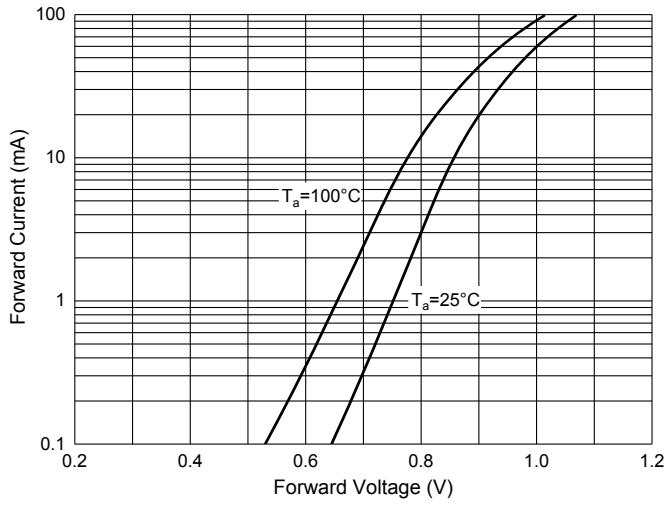

Fig. 2 - Reverse Characteristics

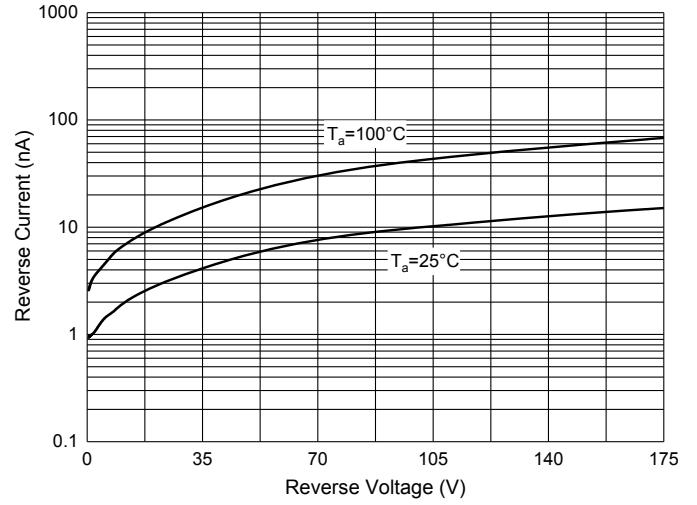

Fig. 3 - Capacitance Characteristics

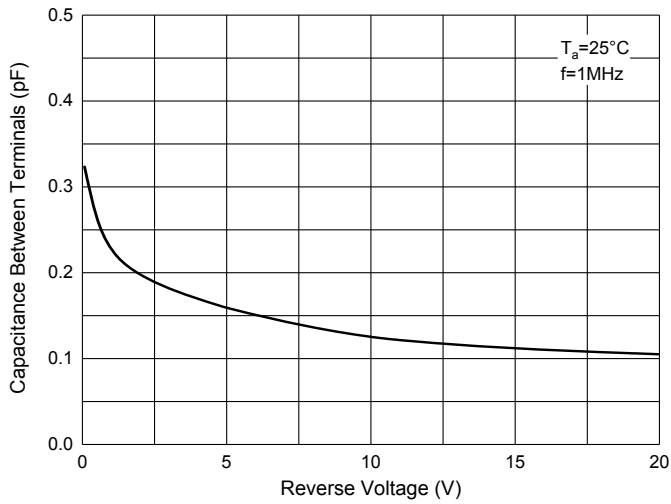
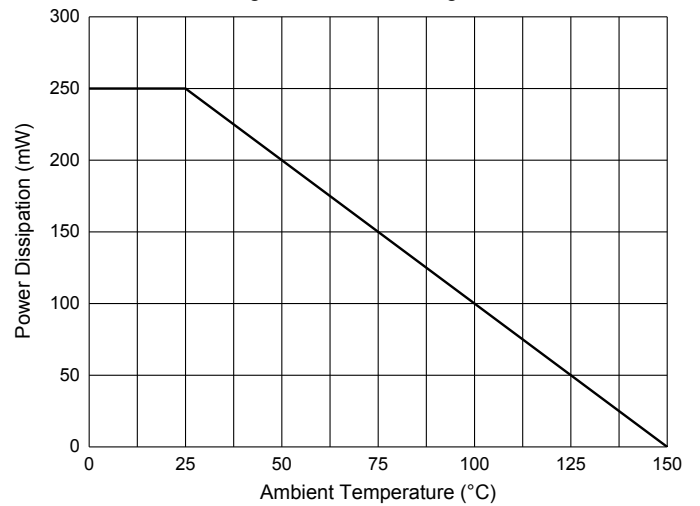

Fig. 4 - Power Derating Curve



Ordering Information

| Device | Packing |
|----------------|-----------------------|
| Part Number-TP | Tape&Reel: 3Kpcs/Reel |

*****IMPORTANT NOTICE*****

Micro Commercial Components Corp. reserves the right to make changes without further notice to any product herein to make corrections, modifications, enhancements, improvements, or other changes. **Micro Commercial Components Corp.** does not assume any liability arising out of the application or use of any product described herein; neither does it convey any license under its patent rights, nor the rights of others. The user of products in such applications shall assume all risks of such use and will agree to hold **Micro Commercial Components Corp.** and all the companies whose products are represented on our website, harmless against all damages.

*****LIFE SUPPORT*****

MCC's products are not authorized for use as critical components in life support devices or systems without the express written approval of Micro Commercial Components Corporation.

*****CUSTOMER AWARENESS*****

Counterfeiting of semiconductor parts is a growing problem in the industry. Micro Commercial Components (MCC) is taking strong measures to protect ourselves and our customers from the proliferation of counterfeit parts. MCC strongly encourages customers to purchase MCC parts either directly from MCC or from Authorized MCC Distributors who are listed by country on our web page cited below. Products customers buy either from MCC directly or from Authorized MCC Distributors are genuine parts, have full traceability, meet MCC's quality standards for handling and storage. **MCC will not provide any warranty coverage or other assistance for parts bought from Unauthorized Sources.** MCC is committed to combat this global problem and encourage our customers to do their part in stopping this practice by buying direct or from authorized distributors.



Компания «ЭлектроПласт» предлагает заключение долгосрочных отношений при поставках импортных электронных компонентов на взаимовыгодных условиях!

Наши преимущества:

- Оперативные поставки широкого спектра электронных компонентов отечественного и импортного производства напрямую от производителей и с крупнейших мировых складов;
- Поставка более 17-ти миллионов наименований электронных компонентов;
- Поставка сложных, дефицитных, либо снятых с производства позиций;
- Оперативные сроки поставки под заказ (от 5 рабочих дней);
- Экспресс доставка в любую точку России;
- Техническая поддержка проекта, помощь в подборе аналогов, поставка прототипов;
- Система менеджмента качества сертифицирована по Международному стандарту ISO 9001;
- Лицензия ФСБ на осуществление работ с использованием сведений, составляющих государственную тайну;
- Поставка специализированных компонентов (Xilinx, Altera, Analog Devices, Intersil, Interpoint, Microsemi, Aeroflex, Peregrine, Syfer, Eurofarad, Texas Instrument, Miteq, Cobham, E2V, MA-COM, Hittite, Mini-Circuits, General Dynamics и др.);

Помимо этого, одним из направлений компании «ЭлектроПласт» является направление «Источники питания». Мы предлагаем Вам помощь Конструкторского отдела:

- Подбор оптимального решения, техническое обоснование при выборе компонента;
- Подбор аналогов;
- Консультации по применению компонента;
- Поставка образцов и прототипов;
- Техническая поддержка проекта;
- Защита от снятия компонента с производства.



Как с нами связаться

Телефон: 8 (812) 309 58 32 (многоканальный)

Факс: 8 (812) 320-02-42

Электронная почта: org@eplast1.ru

Адрес: 198099, г. Санкт-Петербург, ул. Калинина, дом 2, корпус 4, литера А.