

The S-8249 Series is a voltage monitoring IC with a cell balancing function and includes a high-accuracy voltage detection circuit and a delay circuit.

The S-8249 Series is suitable for cell balancing and overcharge protection of batteries and capacitors.

■ Features

- High-accuracy voltage detection circuit

Cell balancing detection voltage: 2.0 V to 4.6 V (5 mV step)	Accuracy ±12 mV ($2.0 \text{ V} \leq V_{BU} < 2.4 \text{ V}$)
	Accuracy ±0.5% ($2.4 \text{ V} \leq V_{BU} \leq 4.6 \text{ V}$)
Cell balancing release voltage: 2.0 V to 4.6 V ^{*1}	Accuracy ±24 mV ($2.0 \text{ V} \leq V_{BL} < 2.4 \text{ V}$)
	Accuracy ±1.0% ($2.4 \text{ V} \leq V_{BL} \leq 4.6 \text{ V}$)
Overcharge detection voltage: 2.0 V to 4.6 V (5 mV step)	Accuracy ±12 mV ($2.0 \text{ V} \leq V_{CU} < 2.4 \text{ V}$)
	Accuracy ±0.5% ($2.4 \text{ V} \leq V_{CU} \leq 4.6 \text{ V}$)
Overcharge release voltage: 2.0 V to 4.6 V ^{*2}	Accuracy ±24 mV ($2.0 \text{ V} \leq V_{CL} < 2.4 \text{ V}$)
	Accuracy ±1.0% ($2.4 \text{ V} \leq V_{CL} \leq 4.6 \text{ V}$)
 - Built-in Nch transistor with ON resistance of 5 Ω typ. between the CB pin and the VSS pin
 - Current consumption: 2.0 μA max. ($T_a = +25^\circ\text{C}$)
 - Delay times are generated only by an internal circuit (External capacitors are unnecessary).
 - CO pin output form and output logic are selectable:

CMOS output	Active "H", active "L"
Nch open-drain output	Active "H", active "L"
 - Switchable to power-saving mode by using the $\overline{\text{CE}}$ pin
 - Operation temperature range: $T_a = -40^\circ\text{C}$ to $+85^\circ\text{C}$
 - Lead-free (Sn 100%), halogen-free
- *1. Cell balancing release voltage = Cell balancing detection voltage – Cell balancing hysteresis voltage
(Cell balancing hysteresis voltage can be selected as 0 V or from a range of 0.1 V to 0.7 V in 50 mV step.)
- *2. Overcharge release voltage = Overcharge detection voltage – Overcharge hysteresis voltage
(Overcharge hysteresis voltage can be selected as 0 V or from a range of 0.1 V to 0.7 V in 50 mV step.)

■ Applications

- Rechargeable battery module
- Capacitor module

■ Package

- SOT-23-6

■ Block Diagram



*1. All diodes shown in the figure are parasitic diodes.

Figure 1

■ Product Name Structure

1. Product name



*1. Refer to the tape drawing.

2. Package

Table 1 Package Drawing Codes

Package Name	Dimension	Tape	Reel
SOT-23-6	MP006-A-P-SD	MP006-A-C-SD	MP006-A-R-SD

3. Product name list

Table 2 (2 / 1)

Product Name	Cell Balancing Detection Voltage [V _{BU}]	Cell Balancing Release Voltage [V _{BL}]	Overcharge Detection Voltage [V _{CU}]	Overcharge Release Voltage [V _{CL}]	CO Pin Output Form	CO Pin Output Logic	Combination of Delay Time
S-8249AAA-M6T1U	2.600 V	2.600 V	2.750 V	2.750 V	CMOS output	Active "H"	(1)
S-8249AAB-M6T1U	3.000 V	3.000 V	3.150 V	3.150 V	CMOS output	Active "H"	(1)
S-8249AAC-M6T1U	3.000 V	3.000 V	3.200 V	3.200 V	CMOS output	Active "H"	(1)
S-8249AAD-M6T1U	3.100 V	3.100 V	3.250 V	3.250 V	CMOS output	Active "H"	(1)
S-8249AAE-M6T1U	3.100 V	3.100 V	3.300 V	3.300 V	CMOS output	Active "H"	(1)
S-8249AAF-M6T1U	2.600 V	2.600 V	2.800 V	2.800 V	CMOS output	Active "H"	(1)
S-8249AAG-M6T1U	2.400 V	2.400 V	2.900 V	2.900 V	CMOS output	Active "H"	(1)
S-8249AAH-M6T1U	2.400 V	2.400 V	3.000 V	3.000 V	CMOS output	Active "H"	(1)
S-8249AAI-M6T1U	2.100 V	2.100 V	3.000 V	3.000 V	CMOS output	Active "H"	(1)
S-8249AAK-M6T1U	2.400 V	2.400 V	3.200 V	3.200 V	CMOS output	Active "H"	(1)
S-8249AAL-M6T1U	2.100 V	2.000 V	3.200 V	3.200 V	CMOS output	Active "H"	(1)
S-8249AAM-M6T1U	2.620 V	2.520 V	2.800 V	2.700 V	CMOS output	Active "H"	(1)
S-8249AAN-M6T1U	3.300 V	3.300 V	4.080 V	3.930 V	CMOS output	Active "H"	(1)
S-8249AAO-M6T1U	2.000 V	2.000 V	3.000 V	3.000 V	CMOS output	Active "H"	(1)
S-8249AAP-M6T1U	3.700 V	3.700 V	4.500 V	4.500 V	CMOS output	Active "H"	(1)
S-8249AAQ-M6T1U	3.800 V	3.800 V	4.080 V	3.930 V	CMOS output	Active "H"	(1)
S-8249AAR-M6T1U	2.800 V	2.800 V	3.150 V	3.150 V	CMOS output	Active "H"	(1)
S-8249AAS-M6T1U	2.800 V	2.800 V	3.200 V	3.200 V	CMOS output	Active "H"	(1)
S-8249AAT-M6T1U	2.800 V	2.800 V	3.100 V	3.100 V	CMOS output	Active "H"	(1)
S-8249AAU-M6T1U	2.500 V	2.400 V	3.800 V	3.700 V	CMOS output	Active "H"	(1)
S-8249AAV-M6T1U	2.300 V	2.200 V	3.800 V	3.700 V	CMOS output	Active "H"	(1)
S-8249AAW-M6T1U	2.650 V	2.600 V	2.750 V	2.650 V	Nch open-drain output	Active "L"	(1)
S-8249AAY-M6T1U	4.150 V	4.150 V	4.275 V	4.275 V	CMOS output	Active "H"	(2)

Table 2 (2 / 2)

Product Name	Cell Balancing Detection Voltage [V _{BU}]	Cell Balancing Release Voltage [V _{BL}]	Overcharge Detection Voltage [V _{CU}]	Overcharge Release Voltage [V _{CL}]	CO Pin Output Form	CO Pin Output Logic	Combination of Delay Time
S-8249ABA-M6T1U	3.650 V	3.550 V	3.800 V	3.500 V	CMOS output	Active "L"	(3)
S-8249ABB-M6T1U	4.350 V	4.350 V	4.425 V	4.325 V	CMOS output	Active "L"	(3)
S-8249ABC-M6T1U	4.200 V	4.200 V	4.300 V	4.200 V	CMOS output	Active "L"	(4)

- Remark 1.** Contact our sales office for the products with detection voltage values other than those specified above.
2. Set $V_{CU} > V_{BU}$.
 3. Refer to **Table 3** for details about combinations of delay times.

Table 3

Combination of Delay Time	Cell Balancing Detection Delay Time [t _{BU}]	Cell Balancing Release Delay Time [t _{BL}]	Overcharge Detection Delay Time [t _{CU}]	Overcharge Release Delay Time [t _{CL}]
(1)	128 ms	1.0 ms	128 ms	1.0 ms
(2)	128 ms	1.0 ms	1024 ms	1.0 ms
(3)	64 ms	2.0 ms	256 ms	2.0 ms
(4)	64 ms	2.0 ms	256 ms	1.0 ms

Remark The delay times can be changed within the ranges listed above. For details, please contact our sales office.

Table 4

Delay Time	Symbol	Selection Range					Remark
Cell balancing detection delay time ^{*1}	t _{BU}	64 ms	128 ms ^{*2}	256 ms	512 ms	1024 ms	Select a value from the left.
Cell balancing release delay time	t _{BL}	0.5 ms		1.0 ms ^{*2}		2.0 ms	Select a value from the left.
Overcharge detection delay time ^{*1}	t _{CU}	64 ms	128 ms ^{*2}	256 ms	512 ms	1024 ms	Select a value from the left.
Overcharge release delay time	t _{CL}	0.5 ms		1.0 ms ^{*2}		2.0 ms	Select a value from the left.

*1. Set $t_{CU} \geq t_{BU}$.

*2. The value is the delay time of the standard products.

■ **Pin Configuration**

1. **SOT-23-6**



Figure 2

Table 5

Pin No.	Symbol	Description
1	CO	Output pin for overcharge signal
2	VSS	Input pin for negative power supply
3	DP	Test mode switching pin "H": Test mode (used to shorten the delay time) "L": Normal operation mode
4	\overline{CE}	Power-saving mode switching pin "H": Power-saving mode "L": Normal operation mode
5	VDD	Input pin for positive power supply
6	CB	Output pin for cell balancing signal (Nch open-drain output)

■ **Absolute Maximum Ratings**

Table 6

(Ta = +25°C unless otherwise specified)

Item	Symbol	Applied Pin	Absolute Maximum Rating	Unit
Input voltage between VDD pin and VSS pin	V _{DS}	VDD	V _{SS} – 0.3 to V _{SS} + 6.0	V
Input pin voltage	V _{IN}	CE, DP	V _{SS} – 0.3 to V _{DD} + 0.3 ≤ V _{SS} + 6.0	V
Output pin voltage	V _{OUT}	CO, CB	V _{SS} – 0.3 to V _{DD} + 0.3 ≤ V _{SS} + 6.0	V
Output pin current	I _{CB}	CB	100 (–40°C to +85°C)	mA
Operation ambient temperature	T _{opr}	–	–40 to +85	°C
Storage temperature	T _{stg}	–	–55 to +125	°C

Caution The absolute maximum ratings are rated values exceeding which the product could suffer physical damage. These values must therefore not be exceeded under any conditions.

■ **Thermal Resistance Value**

Table 7

Item	Symbol	Condition	Min.	Typ.	Max.	Unit	
Junction-to-ambient thermal resistance*1	θ _{JA}	SOT-23-6	Board A	–	159	–	°C/W
			Board B	–	124	–	°C/W
			Board C	–	–	–	°C/W
			Board D	–	–	–	°C/W
			Board E	–	–	–	°C/W

*1. Test environment: compliance with JEDEC STANDARD JESD51-2A

Remark Refer to "■ Power Dissipation" and "Test Board" for details.

■ Electrical Characteristics

For details about the test circuits and testing method, refer to "■ Test Circuit".

Caution Unless otherwise specified in Table 8, set V2 = V3 = 0 V, and SWn (n = 1 to 4) = OFF.

Table 8 (1 / 2)

(Ta = +25°C unless otherwise specified)

Item	Symbol	Condition	Min.	Typ.	Max.	Unit	
Detection voltage							
Cell balancing detection voltage	V _{BU}	SW1 = ON	2.0 V ≤ V _{BU} < 2.4 V	V _{BU} - 0.012	V _{BU}	V _{BU} + 0.012	V
			2.4 V ≤ V _{BU} ≤ 4.6 V	V _{BU} × 0.995	V _{BU}	V _{BU} × 1.005	V
Cell balancing release voltage	V _{BL}	SW1 = ON	2.0 V ≤ V _{BL} < 2.4 V	V _{BL} - 0.024	V _{BL}	V _{BL} + 0.024	V
			2.4 V ≤ V _{BL} ≤ 4.6 V	V _{BL} × 0.99	V _{BL}	V _{BL} × 1.01	V
Overcharge detection voltage	V _{CU}	2.0 V ≤ V _{CU} < 2.4 V		V _{CU} - 0.012	V _{CU}	V _{CU} + 0.012	V
		2.4 V ≤ V _{CU} ≤ 4.6 V		V _{CU} × 0.995	V _{CU}	V _{CU} × 1.005	V
Overcharge release voltage	V _{CL}	2.0 V ≤ V _{CL} < 2.4 V		V _{CL} - 0.024	V _{CL}	V _{CL} + 0.024	V
		2.4 V ≤ V _{CL} ≤ 4.6 V		V _{CL} × 0.99	V _{CL}	V _{CL} × 1.01	V
Temperature coefficient							
Detection voltage temperature coefficient 1*1	$\frac{\Delta V_{BU}}{\Delta Ta \cdot V_{BU}}$	Ta = -40°C to +85°C*3		-	100	350	ppm/°C
Detection voltage temperature coefficient 2*2	$\frac{\Delta V_{CU}}{\Delta Ta \cdot V_{CU}}$	Ta = -40°C to +85°C*3		-	100	350	ppm/°C
Input voltage							
Operation voltage between VDD pin and VSS pin	V _{DS}	Voltages output from CO pin and CB pin are fixed		1.5	-	5.0	V
CE pin voltage "H"	V _{CEH}	-		-	-	V _{DD} × 0.9	V
CE pin voltage "L"	V _{CEL}	-		V _{DD} × 0.1	-	-	V
DP pin voltage "H"	V _{DPH}	-		-	-	V _{DD} × 0.9	V
DP pin voltage "L"	V _{DPL}	-		V _{DD} × 0.1	-	-	V
Input current							
Current consumption during operation	I _{OPE}	I _{VDD} when V1 = V _{BL} - 0.1 V		-	1.2	2.0	μA
Current consumption during power-saving	I _{PSV}	I _{VDD} when V1 = V2 = V _{BL} - 0.1 V		-	-	0.1	μA

*1. A change in the temperature of the detection voltage [mV/°C] is calculated by using the following equation.

$$\frac{\Delta V_{BU}}{\Delta Ta} [\text{mV}/^\circ\text{C}] = V_{BU} [\text{V}] \times \frac{\Delta V_{BU}}{\Delta Ta \cdot V_{BU}} [\text{ppm}/^\circ\text{C}] \div 1000$$

*2. A change in the temperature of the detection voltage [mV/°C] is calculated by using the following equation.

$$\frac{\Delta V_{CU}}{\Delta Ta} [\text{mV}/^\circ\text{C}] = V_{CU} [\text{V}] \times \frac{\Delta V_{CU}}{\Delta Ta \cdot V_{CU}} [\text{ppm}/^\circ\text{C}] \div 1000$$

*3. Since products are not screened at high and low temperature, the specification for this temperature range is guaranteed by design, not tested in production.

Remark 1. $\frac{\Delta V_{BU}}{\Delta Ta}, \frac{\Delta V_{CU}}{\Delta Ta}$: Change in temperature of detection voltage

2. V_{BU}, V_{CU}: Set detection voltage

3. $\frac{\Delta V_{BU}}{\Delta Ta \cdot V_{BU}}, \frac{\Delta V_{CU}}{\Delta Ta \cdot V_{CU}}$: Detection voltage temperature coefficient

Table 8 (2 / 2)

(Ta = +25°C unless otherwise specified)

Item	Symbol	Condition	Min.	Typ.	Max.	Unit
Delay time						
Cell balancing detection delay time	t _{BU}	–	t _{BU} × 0.8	t _{BU}	t _{BU} × 1.2	ms
Cell balancing release delay time	t _{BL}	–	t _{BL} × 0.8	t _{BL}	t _{BL} × 1.2	ms
Overcharge detection delay time	t _{CU}	–	t _{CU} × 0.8	t _{CU}	t _{CU} × 1.2	ms
Overcharge release delay time	t _{CL}	–	t _{CL} × 0.8	t _{CL}	t _{CL} × 1.2	ms
Output current						
CB pin output current						
CB pin sink current	I _{CBS}	V1 = V _{BU} + 0.1 V, SW2 = ON, V4 = 0.5 V	30	–	–	mA
CB pin leakage current	I _{CBL}	V1 = V _{BL} – 0.1 V, SW2 = ON, V4 = 6.0 V	–	–	0.1	μA
CO pin output current (output form: CMOS output, output logic: active "H")						
CO pin sink current	I _{COL}	V1 = V _{CL} – 0.1 V, SW4 = ON, V5 = 0.5 V	5.0	–	–	mA
CO pin source current	I _{COH}	V1 = V _{CU} + 0.1 V, SW4 = ON, V5 = V1 – 0.5 V	1.0	–	–	mA
CO pin output current (output form: CMOS output, output logic: active "L")						
CO pin sink current	I _{COL}	V1 = V _{CU} + 0.1 V, SW4 = ON, V5 = 0.5 V	5.0	–	–	mA
CO pin source current	I _{COH}	V1 = V _{CL} – 0.1 V, SW4 = ON, V5 = V1 – 0.5 V	1.0	–	–	mA
CO pin output current (output form: Nch open-drain output, output logic: active "H")						
CO pin sink current	I _{COL}	V1 = V _{CL} – 0.1 V, SW4 = ON, V5 = 0.5 V	5.0	–	–	mA
CO pin leakage current	I _{COHL}	V1 = V _{CU} + 0.1 V, SW4 = ON, V5 = 6.0 V	–	–	0.1	μA
CO pin output current (output form: Nch open-drain output, output logic: active "L")						
CO pin sink current	I _{COL}	V1 = V _{CU} + 0.1 V, SW4 = ON, V5 = 0.5 V	5.0	–	–	mA
CO pin leakage current	I _{COHL}	V1 = V _{CL} – 0.1 V, SW4 = ON, V5 = 6.0 V	–	–	0.1	μA

■ Test Circuit



Figure 3

Caution Unless otherwise specified in Table 8, set $V2 = V3 = 0\text{ V}$, and SWn ($n = 1$ to 4) = OFF.

1. \overline{CE} pin voltage "H"

\overline{CE} pin voltage "H" ($V_{\overline{CE}H}$) is defined as the voltage at which I_{VDD} is changed from I_{OPE} to I_{PSV} when $V2$ is increased from 0 V after setting $V1 = V_{BL} - 0.1\text{ V}$.

2. \overline{CE} pin voltage "L"

\overline{CE} pin voltage "L" ($V_{\overline{CE}L}$) is defined as the voltage at which I_{VDD} is changed from I_{PSV} to I_{OPE} when $V2$ is decreased from $V_{BL} - 0.1\text{ V}$ after setting $V1 = V2 = V_{BL} - 0.1\text{ V}$.

3. DP pin voltage "H"^{*1}

DP pin voltage "H" (V_{DPH}) is defined as the voltage at which the test mode is switched when $V3$ is increased from 0 V after setting $V1 = V_{BL} - 0.1\text{ V}$.

4. DP pin voltage "L"^{*1}

DP pin voltage "L" (V_{DPL}) is defined as the voltage at which the normal operation mode is switched when $V3$ is decreased from $V_{BL} - 0.1\text{ V}$ after setting $V1 = V3 = V_{BL} - 0.1\text{ V}$.

5. Cell balancing detection delay time

Cell balancing detection delay time (t_{BU}) is defined as the time from when $SW1$ is set to ON and $V1$ is set to $V_{BU} - 0.1\text{ V}$ to when the CB pin output is inverted after setting $V1$ to $V_{BU} + 0.1\text{ V}$.

6. Cell balancing release delay time

Cell balancing release delay time (t_{BL}) is defined as the time from when $SW1$ is set to ON and $V1$ is set to $V_{BL} + 0.1\text{ V}$ to when the CB pin output is inverted after setting $V1$ to $V_{BL} - 0.1\text{ V}$.

7. Overcharge detection delay time

Overcharge detection delay time (t_{CU}) is defined as the time from when $SW1$ is set to ON and $V1$ is set to $V_{CU} - 0.1\text{ V}$ to when the CO pin output is inverted after setting $V1$ to $V_{CU} + 0.1\text{ V}$.

8. Overcharge release delay time

Overcharge release delay time (t_{CL}) is defined as the time from when $SW1$ is set to ON and $V1$ is set to $V_{CL} + 0.1\text{ V}$ to when the CO pin output is inverted after setting $V1$ to $V_{CL} - 0.1\text{ V}$.

*1. For details about switching to the test mode by using the DP pin, refer to "5. DP pin" in "■ Operation".

■ Standard Circuit



Figure 4

Table 9 Constants for External Components

Symbol	Part	Purpose	Min.	Typ.	Max.	Remark
R _{VDD}	Resistor	ESD protection, for power fluctuation control	150 Ω	330 Ω	1.0 kΩ	Resistance should be as small as possible to avoid worsening the overcharge detection accuracy due to current consumption.*1
C _{VDD}	Capacitor	For power fluctuation control	0.068 μF	0.1 μF	1.0 μF	Connect a capacitor of 0.068 μF or more between VDD pin and VSS pin.*1
R _{CB}	Resistor	For setting the cell balancing current value	—	—	—	Set the required cell balancing current value depending on "2. Cell balancing status" in "■ Operation".*2

*1. When connecting a resistor less than 150 Ω to R_{VDD} or a capacitor less than 0.068 μF to C_{VDD}, the S-8249 Series may malfunction when power is largely fluctuated.

*2. Set the cell balancing current value so that R_{CB} does not exceed the power dissipation.

Cautions 1. The above constants may be changed without notice.

2. The example of connection shown above and the constant do not guarantee proper operation. Perform thorough evaluation using the actual application to set the constant.

■ Operation

Remark Refer to "■ Standard Circuit".

1. Normal status

In the S-8249 Series, if the voltage between the VDD pin and the VSS pin (V_{DS}) has not reached the cell balancing detection voltage (V_{BU}), the CB pin output is in the high-impedance status. The CO pin output status varies according to the output form and output logic selected, as shown in **Table 10**. This is the normal status.

Table 10

CO Pin Output Form and Output Logic	CB Pin Output	CO Pin Output
CMOS output, active "H"	"H"	"L"
CMOS output, active "L"	"H"	"H"
Nch open-drain output, active "H"	"H"	"L"
Nch open-drain output, active "L"	"H"	"H"

2. Cell balancing status

In the S-8249 Series, if V_{DS} is V_{BU} or higher and this status continues for the cell balancing detection delay time (t_{BU}) or longer, the CB pin output becomes "L". This is the cell balancing status.

The cell balancing status is released when V_{DS} drops to the cell balancing release voltage (V_{BL}) or lower and this status continues for the cell balancing release delay time (t_{BL}) or longer.

The S-8249 Series includes an Nch transistor with ON resistance of 5Ω typ. (R_{CBON}) between the CB pin and the VSS pin, thus causing the cell balancing current (I_{CB}) to flow in cell balancing status, and the cell balancing operation to start.

By connecting a resistor (R_{CB}) to the CB pin, I_{CB} in cell balancing status can be calculated by using the following equation.

$$I_{CB} = V_{BU} / (R_{CBON} + R_{CB})$$

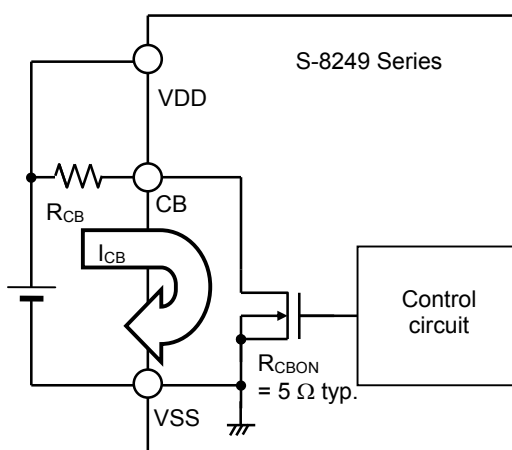

Figure 5

3. Overcharge status

In the S-8249 Series, if V_{DS} is the overcharge detection voltage (V_{CU}) or higher and this status continues for the overcharge detection delay time (t_{CU}) or longer, the CO pin output is inverted. The CO pin output status varies according to the output form and output logic selected, as shown in **Table 11**. This is the overcharge status. In the overcharge status, the CB pin output becomes "L".

Table 11

CO Pin Output Form and Output Logic	CB Pin Output	CO Pin Output
CMOS output, active "H"	"L"	"H"
CMOS output, active "L"	"L"	"L"
Nch open-drain output, active "H"	"L"	"H"
Nch open-drain output, active "L"	"L"	"L"

The overcharge status is released when V_{DS} drops to the overcharge release voltage (V_{CL}) or lower and this status continues for the overcharge release delay time (t_{CL}) or longer.

4. \overline{CE} pin

The S-8249 Series has the \overline{CE} pin (Power-saving mode switching pin). The S-8249 Series is set to power-saving mode by inputting a voltage of $V_{\overline{CEH}}$ or higher to the \overline{CE} pin.

Table 12

\overline{CE} Pin	Status
Open ($V_{\overline{CE}} = V_{SS}$)	Normal operation mode
"H" ($V_{\overline{CE}} \geq V_{\overline{CEH}}$)	Power-saving mode
"L" ($V_{\overline{CE}} \leq V_{\overline{CEL}}$)	Normal operation mode

In power-saving mode, the current consumption is decreased to current consumption during power-saving (I_{PSV}). The CB pin or the CO pin output in power-saving mode is the same as that in the normal status.

The \overline{CE} pin is pulled down to V_{SS} by the internal resistor. When in a mode other than power-saving mode, leave the \overline{CE} pin open or short it with V_{SS} .

5. DP pin

The S-8249 Series has the DP pin (Test mode switching pin). The S-8249 Series is set to test mode (used to shorten the delay time) by inputting a voltage of V_{DPH} or higher to the DP pin.

Table 13

DP Pin	Status
Open ($V_{DP} = V_{SS}$)	Normal operation mode
"H" ($V_{DP} \geq V_{DPH}$)	Test mode
"L" ($V_{DP} \leq V_{DPL}$)	Normal operation mode

In test mode, the cell balancing detection delay time (t_{BU}) and overcharge detection delay time (t_{CU}) are shortened to 1/64 of the delay time in the normal operation mode.

The DP pin is pulled down to V_{SS} by the internal resistor. When in a mode other than test mode, leave the DP pin open or short it with V_{SS} .

■ Timing Chart



*1. The CB pin is pulled up by the external resistor.

*2. (1): Normal status
(2): Cell balancing status
(3): Overcharge status

Remark The charger is assumed to charge with a constant current.

Figure 6

■ Precautions

- The application conditions for the input voltage, output voltage, and load current should not exceed the power dissipation.
- Do not apply an electrostatic discharge to this IC that exceeds the performance ratings of the built-in electrostatic protection circuit.
- ABLIC Inc. claims no responsibility for any and all disputes arising out of or in connection with any infringement by products including this IC of patents owned by a third party.

■ **Characteristics (Typical Data)**

1. Current consumption

1.1 I_{OPE} vs. T_a



1.2 I_{PSV} vs. T_a

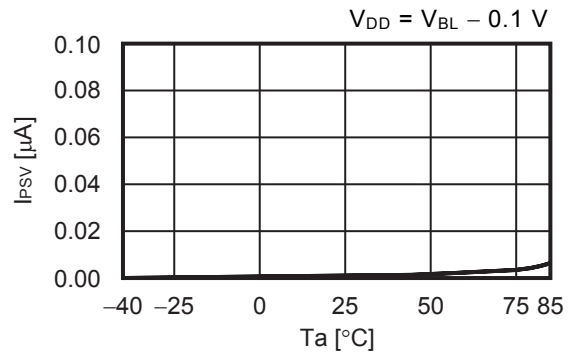

1.3 I_{OPE} vs. V_{DD}



2. Cell balancing detection / release voltage, overcharge detection / release voltage and delay times

2.1 V_{BU} vs. T_a



2.2 V_{BL} vs. T_a

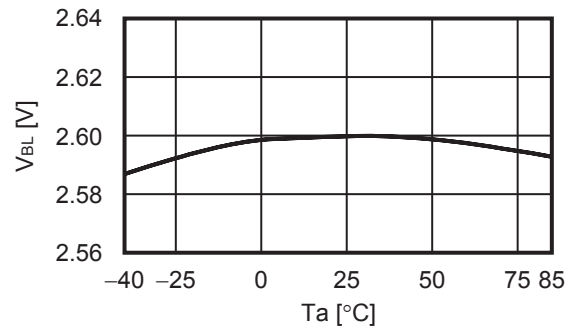

2.3 V_{CU} vs. T_a



2.4 V_{CL} vs. T_a

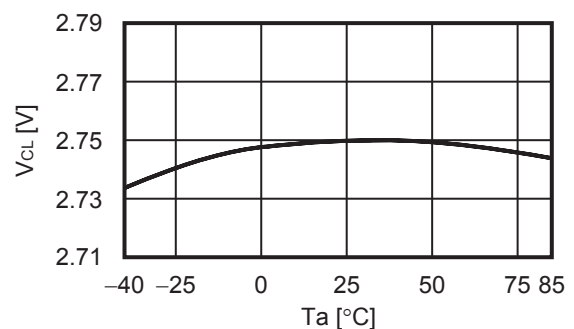

2.5 t_{BU} vs. T_a

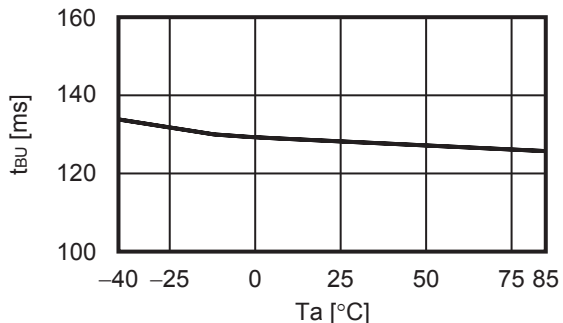

2.6 t_{BL} vs. T_a

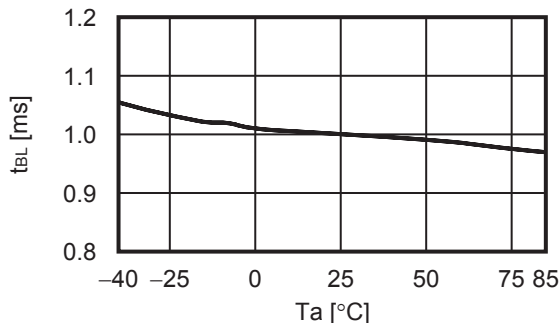

2.7 t_{CU} vs. T_a

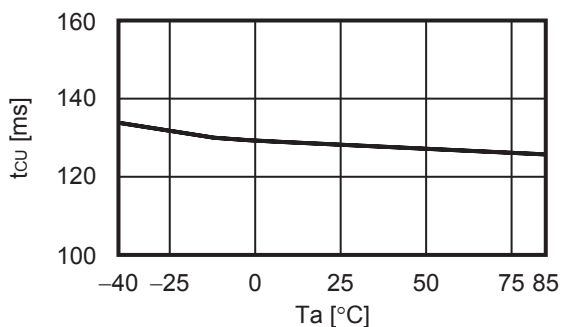

2.8 t_{CL} vs. T_a



3. Output current

3.1 I_{CBL} vs. V_{CB}

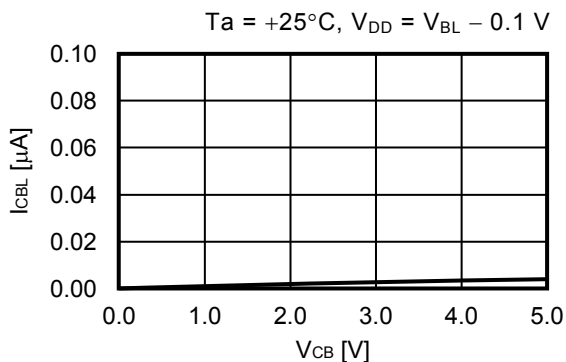

3.2 I_{CBS} vs. V_{CB}



3.3 I_{COH} vs. V_{CO}

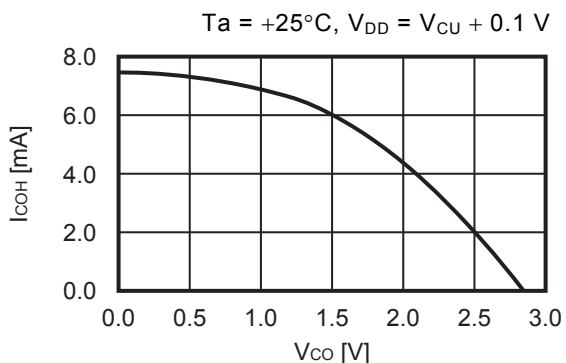

3.4 I_{COL} vs. V_{CO}



■ **Power Dissipation**

SOT-23-6



Board	Power Dissipation (P_D)
A	0.63 W
B	0.81 W
C	—
D	—
E	—

SOT-23-3/3S/5/6 Test Board

 IC Mount Area

(1) Board A



Item	Specification	
Size [mm]	114.3 x 76.2 x t1.6	
Material	FR-4	
Number of copper foil layer	2	
Copper foil layer [mm]	1	Land pattern and wiring for testing: t0.070
	2	-
	3	-
	4	74.2 x 74.2 x t0.070
Thermal via	-	

(2) Board B



Item	Specification	
Size [mm]	114.3 x 76.2 x t1.6	
Material	FR-4	
Number of copper foil layer	4	
Copper foil layer [mm]	1	Land pattern and wiring for testing: t0.070
	2	74.2 x 74.2 x t0.035
	3	74.2 x 74.2 x t0.035
	4	74.2 x 74.2 x t0.070
Thermal via	-	

No. SOT23x-A-Board-SD-2.0



No. MP006-A-P-SD-2.1

TITLE	SOT236-A-PKG Dimensions
No.	MP006-A-P-SD-2.1
ANGLE	
UNIT	mm
ABLIC Inc.	



No. MP006-A-C-SD-3.1

TITLE	SOT236-A-Carrier Tape
No.	MP006-A-C-SD-3.1
ANGLE	
UNIT	mm
ABLIC Inc.	



Enlarged drawing in the central part



No. MP006-A-R-SD-2.1

TITLE	SOT236-A-Reel		
No.	MP006-A-R-SD-2.1		
ANGLE		QTY	3,000
UNIT	mm		
ABLIC Inc.			

Disclaimers (Handling Precautions)

1. All the information described herein (product data, specifications, figures, tables, programs, algorithms and application circuit examples, etc.) is current as of publishing date of this document and is subject to change without notice.
2. The circuit examples and the usages described herein are for reference only, and do not guarantee the success of any specific mass-production design.
ABLIC Inc. is not liable for any losses, damages, claims or demands caused by the reasons other than the products described herein (hereinafter "the products") or infringement of third-party intellectual property right and any other right due to the use of the information described herein.
3. ABLIC Inc. is not liable for any losses, damages, claims or demands caused by the incorrect information described herein.
4. Be careful to use the products within their ranges described herein. Pay special attention for use to the absolute maximum ratings, operation voltage range and electrical characteristics, etc.
ABLIC Inc. is not liable for any losses, damages, claims or demands caused by failures and / or accidents, etc. due to the use of the products outside their specified ranges.
5. Before using the products, confirm their applications, and the laws and regulations of the region or country where they are used and verify suitability, safety and other factors for the intended use.
6. When exporting the products, comply with the Foreign Exchange and Foreign Trade Act and all other export-related laws, and follow the required procedures.
7. The products are strictly prohibited from using, providing or exporting for the purposes of the development of weapons of mass destruction or military use. ABLIC Inc. is not liable for any losses, damages, claims or demands caused by any provision or export to the person or entity who intends to develop, manufacture, use or store nuclear, biological or chemical weapons or missiles, or use any other military purposes.
8. The products are not designed to be used as part of any device or equipment that may affect the human body, human life, or assets (such as medical equipment, disaster prevention systems, security systems, combustion control systems, infrastructure control systems, vehicle equipment, traffic systems, in-vehicle equipment, aviation equipment, aerospace equipment, and nuclear-related equipment), excluding when specified for in-vehicle use or other uses by ABLIC, Inc. Do not apply the products to the above listed devices and equipments.
ABLIC Inc. is not liable for any losses, damages, claims or demands caused by unauthorized or unspecified use of the products.
9. In general, semiconductor products may fail or malfunction with some probability. The user of the products should therefore take responsibility to give thorough consideration to safety design including redundancy, fire spread prevention measures, and malfunction prevention to prevent accidents causing injury or death, fires and social damage, etc. that may ensue from the products' failure or malfunction.
The entire system in which the products are used must be sufficiently evaluated and judged whether the products are allowed to apply for the system on customer's own responsibility.
10. The products are not designed to be radiation-proof. The necessary radiation measures should be taken in the product design by the customer depending on the intended use.
11. The products do not affect human health under normal use. However, they contain chemical substances and heavy metals and should therefore not be put in the mouth. The fracture surfaces of wafers and chips may be sharp. Be careful when handling these with the bare hands to prevent injuries, etc.
12. When disposing of the products, comply with the laws and ordinances of the country or region where they are used.
13. The information described herein contains copyright information and know-how of ABLIC Inc. The information described herein does not convey any license under any intellectual property rights or any other rights belonging to ABLIC Inc. or a third party. Reproduction or copying of the information from this document or any part of this document described herein for the purpose of disclosing it to a third-party is strictly prohibited without the express permission of ABLIC Inc.
14. For more details on the information described herein or any other questions, please contact ABLIC Inc.'s sales representative.
15. This Disclaimers have been delivered in a text using the Japanese language, which text, despite any translations into the English language and the Chinese language, shall be controlling.

2.4-2019.07

Mouser Electronics

Authorized Distributor

Click to View Pricing, Inventory, Delivery & Lifecycle Information:

ABLIC:

[S-8249AAG-M6T1U](#) [S-8249ABB-M6T1U](#) [S-8249AAT-M6T1U](#) [S-8249AAN-M6T1U](#) [S-8249AAW-M6T1U](#) [S-8249AAI-M6T1U](#) [S-8249AAP-M6T1U](#) [S-8249AAU-M6T1U](#) [S-8249AAO-M6T1U](#) [S-8249AAS-M6T1U](#) [S-8249AAM-M6T1U](#) [S-8249AAK-M6T1U](#) [S-8249ABA-M6T1U](#) [S-8249AAY-M6T1U](#) [S-8249AAV-M6T1U](#) [S-8249AAH-M6T1U](#) [S-8249ABC-M6T1U](#) [S-8249AAR-M6T1U](#) [S-8249AAQ-M6T1U](#) [S-8249AAL-M6T1U](#) [S-8249AAA-M6T1U](#) [S-8249AAB-M6T1U](#) [S-8249AAC-M6T1U](#) [S-8249AAD-M6T1U](#) [S-8249AAE-M6T1U](#) [S-8249AAF-M6T1U](#)



Компания «ЭлектроПласт» предлагает заключение долгосрочных отношений при поставках импортных электронных компонентов на взаимовыгодных условиях!

Наши преимущества:

- Оперативные поставки широкого спектра электронных компонентов отечественного и импортного производства напрямую от производителей и с крупнейших мировых складов;
- Поставка более 17-ти миллионов наименований электронных компонентов;
- Поставка сложных, дефицитных, либо снятых с производства позиций;
- Оперативные сроки поставки под заказ (от 5 рабочих дней);
- Экспресс доставка в любую точку России;
- Техническая поддержка проекта, помощь в подборе аналогов, поставка прототипов;
- Система менеджмента качества сертифицирована по Международному стандарту ISO 9001;
- Лицензия ФСБ на осуществление работ с использованием сведений, составляющих государственную тайну;
- Поставка специализированных компонентов (Xilinx, Altera, Analog Devices, Intersil, Interpoint, Microsemi, Aeroflex, Peregrine, Syfer, Eurofarad, Texas Instrument, Miteq, Cobham, E2V, MA-COM, Hittite, Mini-Circuits, General Dynamics и др.);

Помимо этого, одним из направлений компании «ЭлектроПласт» является направление «Источники питания». Мы предлагаем Вам помощь Конструкторского отдела:

- Подбор оптимального решения, техническое обоснование при выборе компонента;
- Подбор аналогов;
- Консультации по применению компонента;
- Поставка образцов и прототипов;
- Техническая поддержка проекта;
- Защита от снятия компонента с производства.



Как с нами связаться

Телефон: 8 (812) 309 58 32 (многоканальный)

Факс: 8 (812) 320-02-42

Электронная почта: org@eplast1.ru

Адрес: 198099, г. Санкт-Петербург, ул. Калинина, дом 2, корпус 4, литера А.