

MAX17681 Evaluation Kit

Evaluates: MAX17681 for Isolated +7V or +5V Output Configuration

General Description

The MAX17681EVKITD is a fully assembled and tested circuit board that demonstrates the performance of the MAX17681 high-efficiency, iso-buck DC-DC converter. The EV kit operates over a wide input-voltage range of 17V to 36V and uses primary-side feedback to regulate the output voltage. The EV kit has two output configurations. In the first configuration, the output is programmed to +7V at 200mA, with $\pm 8\%$ output voltage regulation. The second configuration uses a post regulator (MAX17651) to produce +5V at 100mA with at least $\pm 3\%$ regulation.

The EV kit comes installed with the MAX17681 in a 10-pin (3mm x 2mm) TDFN package and MAX17651 in a 6-lead TSOT package.

Features

- 17V to 36V Input Voltage Range
- +7V, 200mA or +5V, 100mA Continuous Current
- EN/UVLO Input
- 200kHz Switching Frequency
- Overcurrent Protection
- No Optocoupler
- Delivers up to 1.4W Output Power
- Overtemperature Protection
- Proven PCB Layout

Ordering Information appears at end of data sheet.

Quick Start

Recommended Equipment

- One 15V–60V DC, 0.5A power supply
- Two resistive loads of 200mA sink capacity
- Four digital multimeters (DMM)

Caution: Do not turn on the power supply until all connections are completed.

Procedure

The EV kit comes with the default output configuration programmed to +7V.

Test Procedure for +7V Output

- 1) Verify that J1 is open.
- 2) Verify that the R7 and R14 are not installed.
- 3) Set the power supply output to 24V. Disable the power supply.
- 4) Connect the positive terminal of the power supply to the V_{IN} PCB pad and the negative terminal to the nearest PGND PCB pad. Connect a 200mA resistive load across the +7V PCB pad and the GND0 PCB pad.
- 5) Connect a DMM configured in voltmeter mode across the +7V PCB pad and the nearest GND0 PCB pad.
- 6) Enable the input power supply.
- 7) Verify that output voltage is at +7V (with allowable tolerance of $\pm 8\%$) with respect to GND0.
- 8) If required, vary the input voltage from 17V to 36V, and the load current from 0mA to 200mA and verify that output voltage is at +7V (with allowable tolerance of $\pm 8\%$).

Test Procedure for +5V Output

- 1) Verify that J1 is open.
- 2) Place 0Ω resistors in R7. Place a 681k pack-out resistor (comes with EV kit package) in R14.
- 3) Set the input power supply output to 24V. Disable the power supply.
- 4) Connect the positive terminal of the power supply to the V_{IN} PCB pad and the negative terminal to the nearest PGND PCB pad. Connect a 100mA resistive load across the +5V PCB pad and the GND0 PCB pad.
- 5) Connect a DMM configured in voltmeter mode across the +5V PCB pad and the nearest GND0 PCB pad.
- 6) Enable the input power supply.
- 7) Verify that output voltage is at +5V (with allowable tolerance of ±3%) with respect to GND0.
- 8) If required, vary the input voltage from 17V to 36V, and the load current from 0mA to 100mA and verify that output voltage is at +5V (with allowable tolerance of ±3%).

Detailed Description

The MAX17681EVKITD evaluation kit (EV kit) is a fully assembled and tested circuit board that demonstrates the performance of the MAX17681 high efficiency, iso-buck DC-DC converter designed to provide an isolated power up to 1.4W. The EV kit generates either +7V, 200mA or +5V, 100mA output from a 17V to 36V input supply. The EV kit features a forced PWM control scheme that provides constant switching-frequency of 200kHz operation at all load and line conditions.

The EV Kit includes an EN/UVLO PCB pad to monitor and program the EN/UVLO pin of the MAX17681. The V_{PR1} PCB pad helps measure the regulated primary output voltage (V_{PR1}). An additional RESET PCB pad is

available for monitoring the health of primary output voltage (V_{PR1}). RESET pulls low if FB voltage drops below 92.5% of its set value. RESET goes high impedance 1024 clock cycles after FB voltage rises above 95.5% of its set value. The programmable soft-start feature allows users to reduce the input inrush current.

The iso-buck is a synchronous-buck-converter-based topology, useful for generating isolated outputs at low power level without using an optocoupler. The detailed procedure for setting the soft-start time, ENABLE/UVLO divider, primary output voltage (V_{PR1}) selection, adjusting the primary output voltage, primary inductance selection, turns-ratio selection, output capacitor selection, output diode selection and external loop compensation are given in the MAX17681 IC data sheet. The post regulator, MAX17651 output voltage setting and the related additional information are detailed in MAX17651 IC data sheet.

Enable Control (J1)

The EN/UVLO pin on the device serves as an on/off control while also allowing the user to program the input undervoltage-lockout (UVLO) threshold. J1 configures the EV kit’s output for turn-on/turn-off control. Install a shunt across J1 pins 2-3 to disable V_{OUT}. See [Table 1](#) for proper J1 configurations.

NOTE 1: The secondary output diodes D1 is rated to carry short-circuit current only for few 100’s of ms and is not rated to carry the continuous short-circuit current.

NOTE 2: The iso-buck converter typically needs 10% minimum load to regulate the output voltage. In this design, when the +7V rail is healthy, U3 sinks the minimum load current required to regulate the output voltages within ±8% regulation.

Table 1. Enable Control (EN/UVLO) (J1) Jumper Settings

SHUNT POSITION	EN/UVLO PIN	VOUT
J1		
1-2	Connected to V _{IN}	Always Enabled
2-3	Connected to GND	Always Disabled
Open*	Connected to midpoint of R1, R2 resistor-divider	Enabled at V _{IN} ≥ 15.5V

*Default position.

EV Kit Performance Report

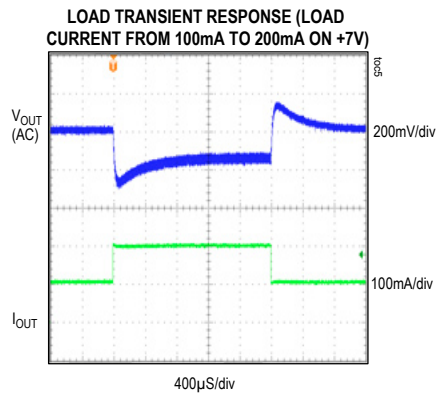
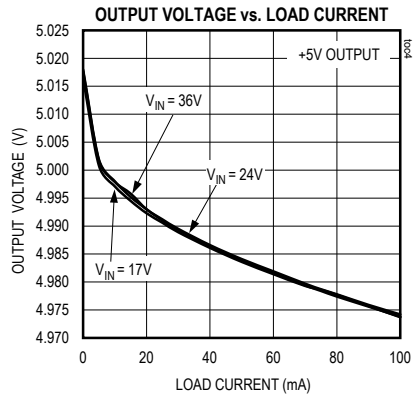
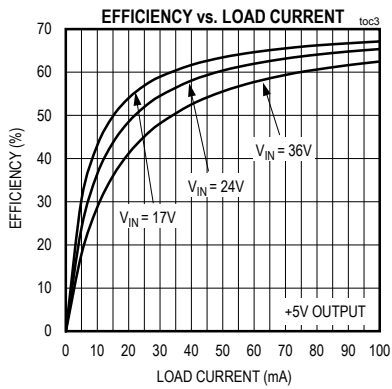
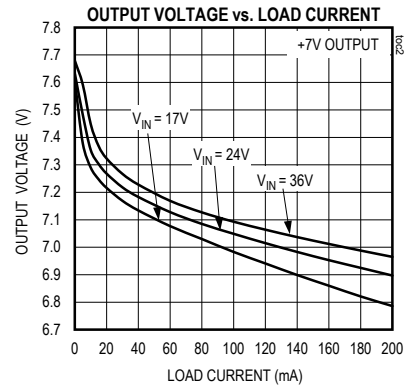
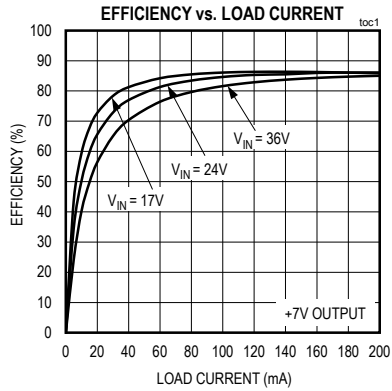

MAX17681 Evaluation Kit

Evaluates: MAX17681 for Isolated
+7V or +5V Output Configuration

Component Suppliers

SUPPLIER	WEBSITE
Würth Elektronik	www.we-online.com
Murata Americas	www.murata.com
Panasonic Corp.	www.panasonic.com

Note: Indicate that you are using the MAX17681 when contacting these component suppliers.

Component Information, PCB Layout, and Schematic

See the following links for component information, PCB layout diagrams, and schematic.

- [MAX17681D EV BOM](#)
- [MAX17681D EV PCB Layout](#)
- [MAX17681D EV Schematic](#)

Ordering Information

PART	TYPE
MAX17681EVKITD#	EVKIT

#Denotes RoHS compliant.

Revision History

REVISION NUMBER	REVISION DATE	DESCRIPTION	PAGES CHANGED
0	2/16	Initial release	—
1	4/16	Updated <i>General Description</i> and <i>Bill of Materials</i>	1, 2

For pricing, delivery, and ordering information, please contact Maxim Direct at 1-888-629-4642, or visit Maxim Integrated's website at www.maximintegrated.com.

Maxim Integrated cannot assume responsibility for use of any circuitry other than circuitry entirely embodied in a Maxim Integrated product. No circuit patent licenses are implied. Maxim Integrated reserves the right to change the circuitry and specifications without notice at any time.

S NO	Designation	Qty	Description	Manufacturer Partnumber-1	Manufacturer Partnumber-2	Manufacturer Partnumber-3	Manufacturer Partnumber-4
1	C1	1	1 μ F \pm 10%, 50V,X7R Ceramic capacitor (1206)	Murata GRM31CR71H105KA61	KEMET C1206C105K5RAC	Murata GRM31MR71H105KA88	
2	C2	1	1 μ F \pm 10% 16V X7R Ceramic capacitor (0603)	Murata GRM188R71C105KA12	KEMET C0603C105K4RAC	TDK C1608X7R1C105K	TAIYO YUDEN EMK107B7105KA
3	C3	1	0.033UFnF \pm 10%,25V, X7R ceramic capacitor (0402)	Murata GRM155R71E333KA88			
4	C4	1	0.082UFnF \pm 10%,16V, X7R ceramic capacitor (0402)	Murata GRM155R71C823K	KEMET C0402C823K4RAC		
5	C5	1	680pF \pm 5%,50V,COG ceramic capacitor (0402)	Murata GRM1555C1H681JA01	VENKEL LTD C0402C0G500-681JNP		
6	C6	1	10uF \pm 10%,16V, X7R ceramic capacitor (1206)	Murata GRM31CR71C106KAC7			
7	C7, C8	2	4.7uF \pm 10%,50V, X7R ceramic capacitor (1206)	Murata GRM31CR71H475KA12			
8	C9	1	2.2uF \pm 10%,50V, X7R ceramic capacitor (1206)	Murata GRM31CR71H225KA88	TAIYO YUDEN UMK316B7225K		
9	C10	1	0.1uF \pm 10%, 25V, X7R ceramic capacitor(0402)	Murata GRM155R71E104KE14			
10	C11	1	0.01uF \pm 10%, 50V, X7R ceramic capacitor (0402)	Murata GRM155R71H103KA88	KEMET C0402C103K5RAC		
11	C12	1	22uF, 20%, 50V, ALUMINUM ELECTROLYTIC CAPACITOR 6.60*6.60mm,	Panasonic EEEFK1H220P			
12	C13	1	1000pF \pm 10%, 1500V, X7R ceramic capacitor (1206)	AVX 1206SC102KAT			
13	D1	1	100V/2A, PowerDI [®] 123	Diode Inc. DFLS2100			
14	J1	1	3-pin headers	SULLINS ELECTRONICS CORP PEC03SAAN			
15	R1	1	3.01M Ohm \pm 1% resistor (0402)	VISHAY DALE CRCW04023M01FK			
16	R2	1	261K Ohm \pm 1% resistor (0402)	VISHAY DALE CRCW0402261KFK			
17	R3	1	78.7K Ohm \pm 1% resistor (0402)	VISHAY DALE CRCW040278K7FK			
18	R4	1	10.5k Ω \pm 1% resistor (0402)	PANASONIC ERJ-2RKF1052			
19	R5	1	4.025k Ω \pm 1% resistor (0402)	VISHAY CRCW04024K02FK	PANASONIC ERJ-2RKF4021X		
20	R6	1	100k Ω \pm 5% resistor (0402)	PANASONIC ERJ-2GEJ104X			
21	R7	1	OPEN (0402)				

22	R8	1	115kΩ ±1% resistor (0402)	VISHAY DALE CRCW0402115KFK			
23	R9	1	22kΩ ±1% resistor (0402)	VISHAY DALE CRCW040222K0FK			
24	R10	1	22Ω ±1% resistor (0402)	VISHAY DALE CRCW040222R0FK			
25	R11	1	232kΩ ±1% resistor (0402)	VISHAY DALE CRCW0402232KFK			
26	R12	1	432kΩ ±1% resistor (0402)	VISHAY DALE CRCW0402432KFK			
27	R13	1	59kΩ ±1% resistor (0402)	VISHAY DALE CRCW040259K0FK	VENKEL LTD CR0402-16W- 5902FT		
28	T1	1	EP7, 8-pin SMT, 50μH,1.2A,(4-1):(6-7):(5-8)=1:1:1	WURTH ELECTRONICS INC. 750342878			
29	U1	1	MAX17681 TDFN10 3*2mm Iso buck DC-DC converter	MAX17681ATB+			
30	U2	1	MAX17651 TSOT LDO	MAX17651AZT+			
31	U3	1	Shunt regulator SOT25	Diode Inc. TL431BW5			

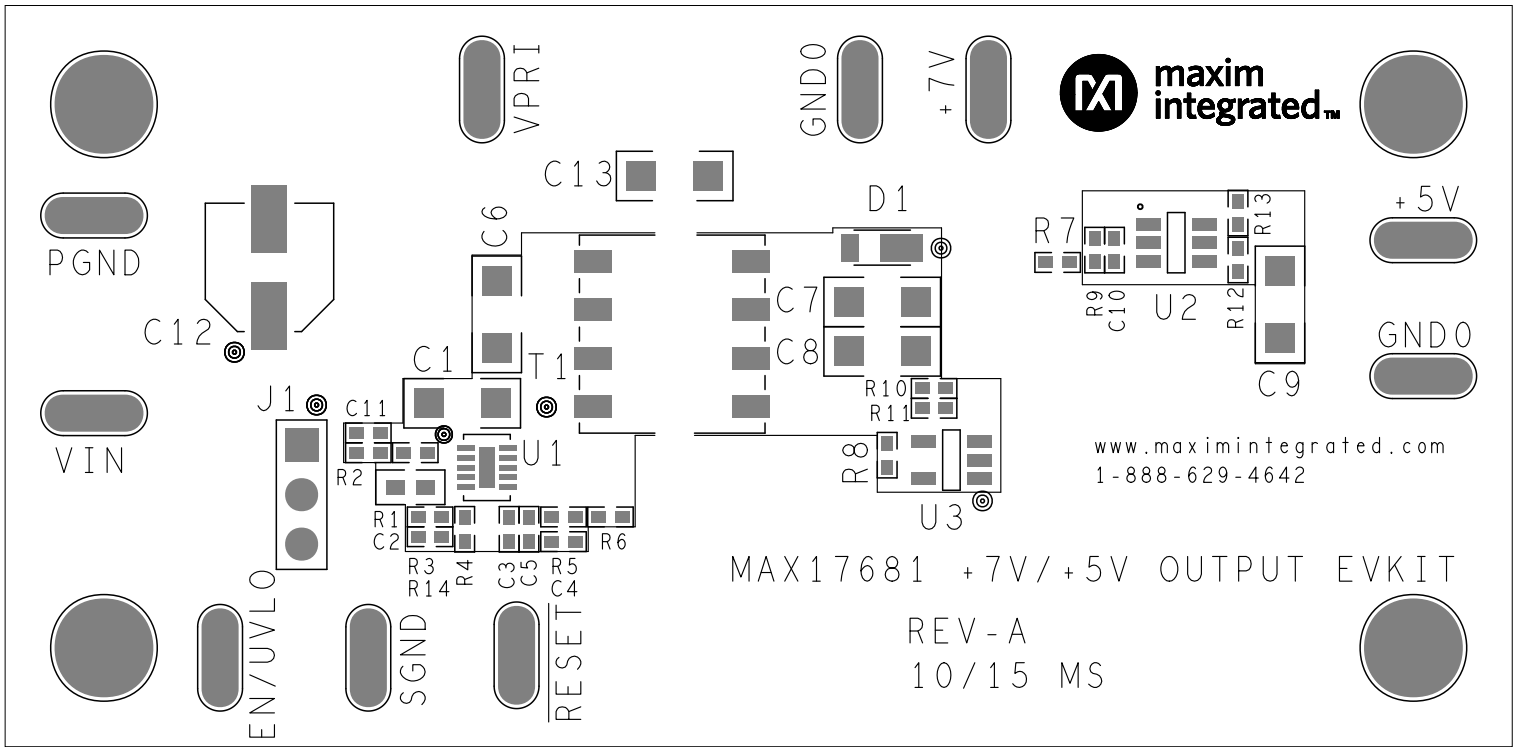

TOP SILKSCREEN

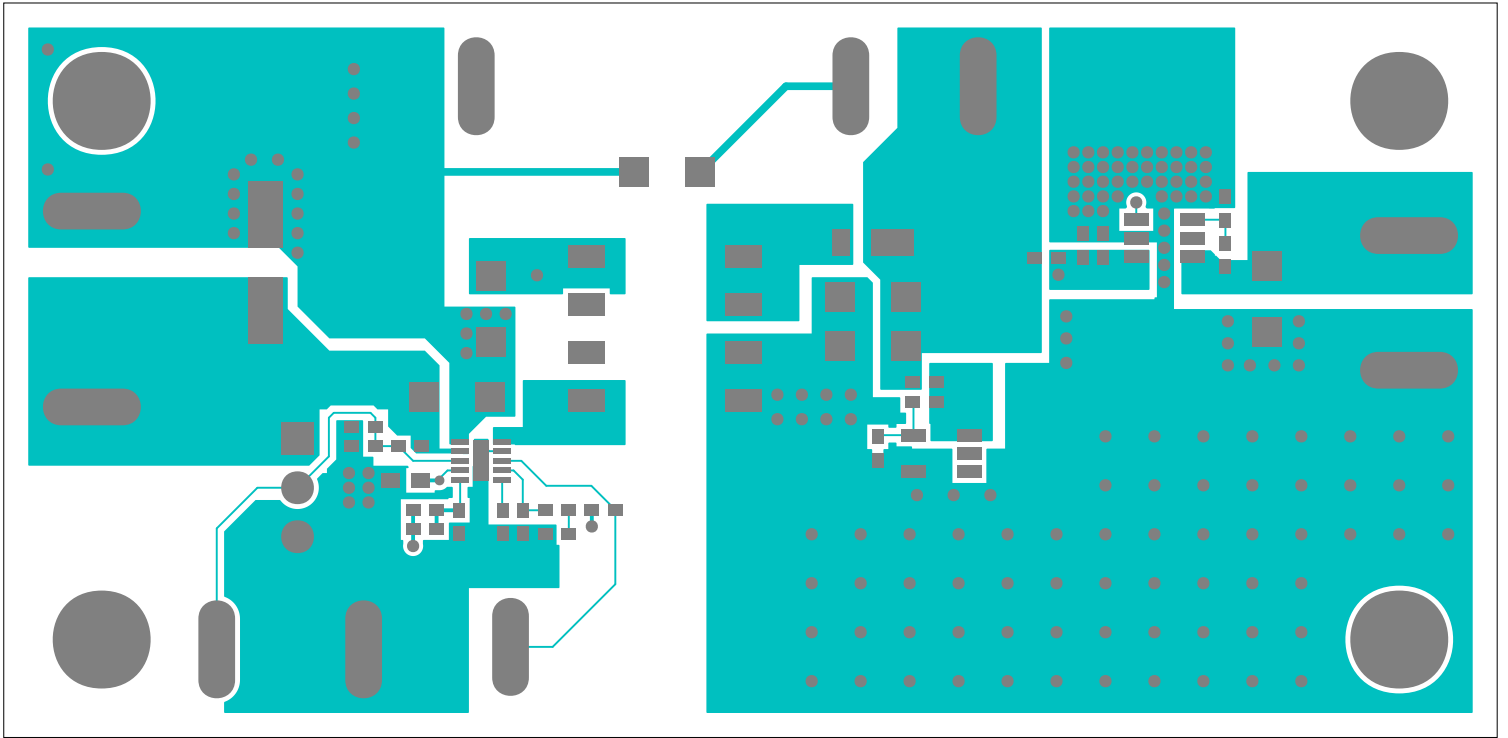

TOP

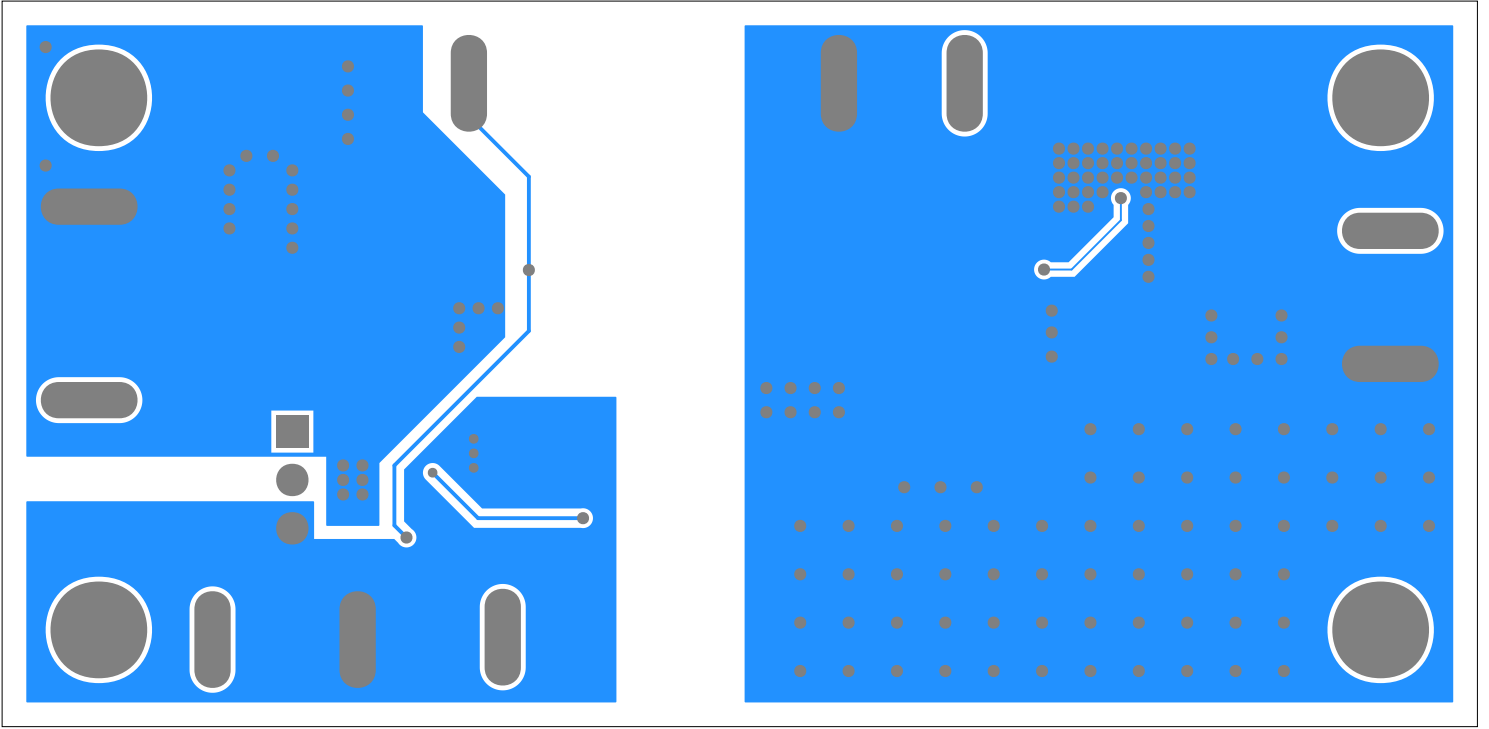

BOTTOM

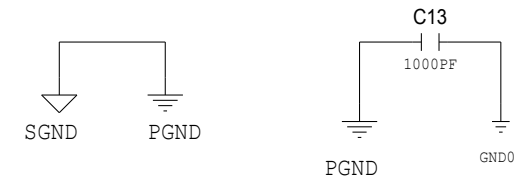
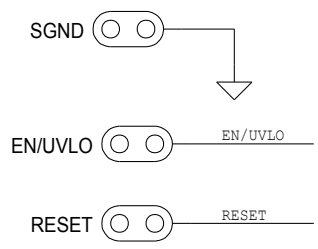
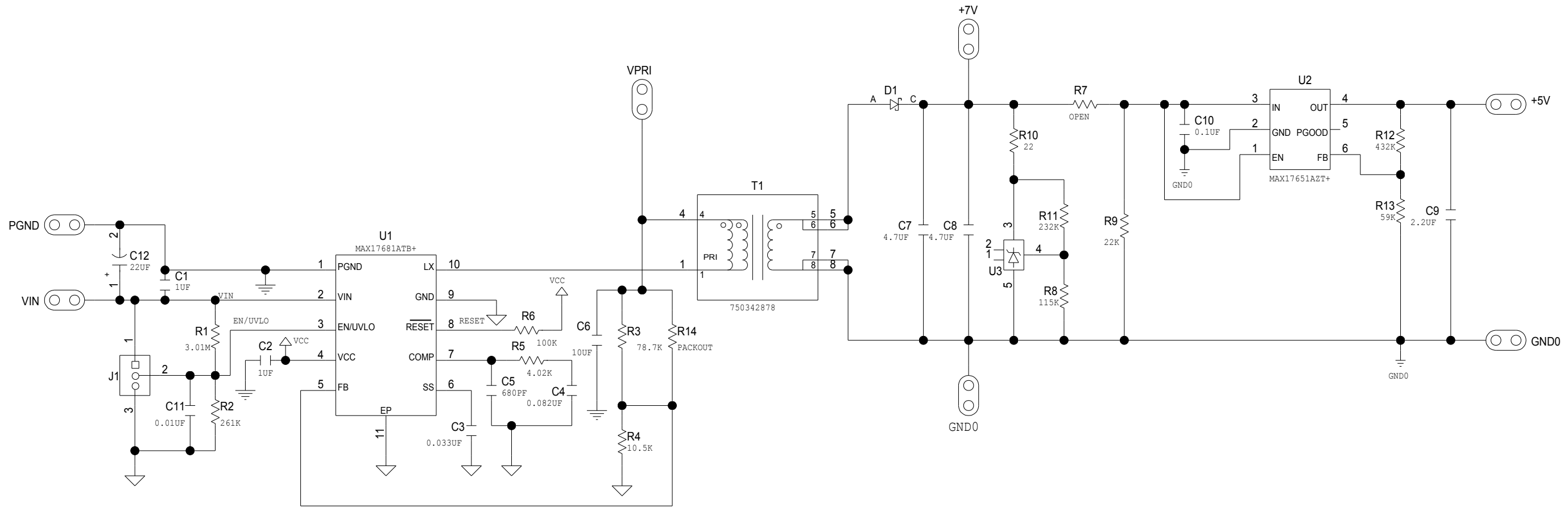



Компания «ЭлектроПласт» предлагает заключение долгосрочных отношений при поставках импортных электронных компонентов на взаимовыгодных условиях!

Наши преимущества:

- Оперативные поставки широкого спектра электронных компонентов отечественного и импортного производства напрямую от производителей и с крупнейших мировых складов;
- Поставка более 17-ти миллионов наименований электронных компонентов;
- Поставка сложных, дефицитных, либо снятых с производства позиций;
- Оперативные сроки поставки под заказ (от 5 рабочих дней);
- Экспресс доставка в любую точку России;
- Техническая поддержка проекта, помощь в подборе аналогов, поставка прототипов;
- Система менеджмента качества сертифицирована по Международному стандарту ISO 9001;
- Лицензия ФСБ на осуществление работ с использованием сведений, составляющих государственную тайну;
- Поставка специализированных компонентов (Xilinx, Altera, Analog Devices, Intersil, Interpoint, Microsemi, Aeroflex, Peregrine, Syfer, Eurofarad, Texas Instrument, Miteq, Cobham, E2V, MA-COM, Hittite, Mini-Circuits, General Dynamics и др.);

Помимо этого, одним из направлений компании «ЭлектроПласт» является направление «Источники питания». Мы предлагаем Вам помощь Конструкторского отдела:

- Подбор оптимального решения, техническое обоснование при выборе компонента;
- Подбор аналогов;
- Консультации по применению компонента;
- Поставка образцов и прототипов;
- Техническая поддержка проекта;
- Защита от снятия компонента с производства.



Как с нами связаться

Телефон: 8 (812) 309 58 32 (многоканальный)

Факс: 8 (812) 320-02-42

Электронная почта: org@eplast1.ru

Адрес: 198099, г. Санкт-Петербург, ул. Калинина, дом 2, корпус 4, литера А.