

REFERENCE SPECIFICATIONS

-NFC 93425 (in compliance with HE 507)

PHYSICAL CHARACTERISTICS

- INSULATOR MATERIAL: THERMOPLASTIC UL94V0
- CONTACT MATERIAL: PHOSPHOR BRONZE(SIGNAL CONTACT), GOLD OVER NICKEL
- ACCESSORIES: STAINLESS STEEL or BRASS, cadmium plated yellow passivation
- SHELLS: STEEL, cadmium plated yellow passivation

ELECTRICAL CHARACTERISTICS

- NOMINAL CURRENT: 7.5A (SIGNAL CONTACT)
- CONTACT RESISTANCE: <=7.3 m Ohms SIGNAL
- CONTACT/CONTACT : >=1000 V
- CONTACT/GROUND : >=1200 V
- INSULATION RESISTANCE: >=5000 MOhms
- CLIMATIC CATEGORY: 55/125/21
 - TEMPERATURE RANGE -55°C TO +125°C
 - DAMP HEAT STEADY STATE 56 DAYS
 - SALT SPRAY 48 HOURS

DBML13W3S400N

Series ←

Shell size: **E A B C D** ←
see sheet 3

M :characteristic for the DM series

Front accessory definition see sheet 2

Blank :without accessory

L :threaded insert M3

O :threaded insert UNC 4-40

V :female screw UNC 4-40

F :floating mounting

S :spacer

Layout of contacts (see sheet 3) ←

Contacts ←

S :Socket

Termination type ←

4 3 level wire wrap

Plating ←

00 straight solder 500 matings/unmatings

43 straight solder 500 matings/unmatings for harsh environment

N :obligatory indication for HE 507 series ←

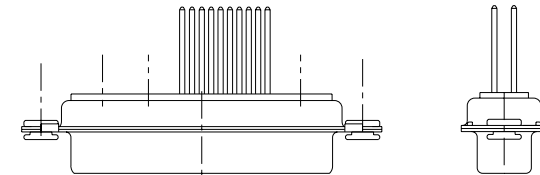

I3W3 FOR EXAMPLE

www.fciconnect.com				surface	tolerance std	projection	mm	
				ISO 1302	ISO 406 ISO 1101	⊕	← →	
				TOLERANCES UNLESS OTHERWISE SPECIFIED				
rev	ecn no	dr	date	Dr	M PESSON	2006/11/14	ANGULAR	LINEAR
A	LS06-0174	MLE	2006/11/14	Eng	P LEGARE	2006/11/14	0.X	±0.3
B	LS07-0273	MPE	2007/10/30	Chr	P LEGARE	2006/11/14	0.xx	±0.1
-	-	-	-	Appr	P LEGARE	2006/11/14	0.xxx	±0.05
				Product family		size A2 Scale 2:1		
				FCI		ECN LS07-0273		Rev. B
				SUB FEMALE DMW		- Spec ref		
				mixed power 3 level wire wrap		C01-8637-1755		
				catalog no		CUSTOMER		sheet 1 of 7

Copyright FCI, FCI

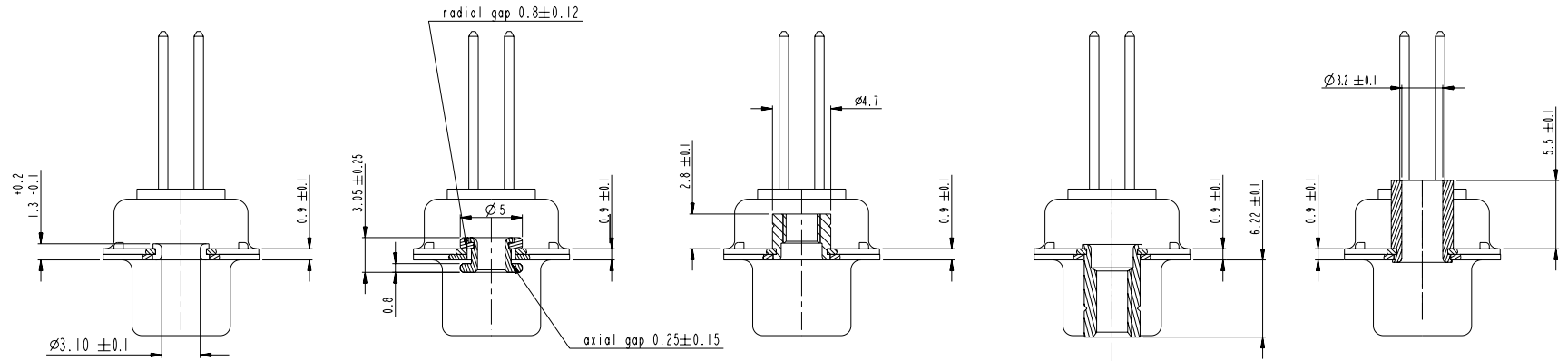

FRONT ACCESSORY **Blank** without **F** floating mounting **L** insert M3 **O** insert UNC 4.40 **V** femelle screw UNC 4.40 **S** Spacer

shell size LAYOUTS

PART NUMBER	FRONT ACCESSORY
D*MxWxS400N	without
D*MFxWxS400N	floating mounting
D*MLxWxS400N	insert M3
D*MOxWxS400N	insert UNC 4.40
D*MVxWxS400N	female screw UNC 4.40
D*MSxWxS400N	Spacer
D*MxWxS443N	without
D*MFxWxS443N	floating mounting
D*MLxWxS443N	insert M3
D*MOxWxS443N	insert UNC 4.40
D*MVxWxS443N	female screw UNC 4.40
D*MSxWxS443N	Spacer

#	xWx
E	5W1
A	11W1
A	7W2
B	21W1
B	17W2
B	13W3
B	9W4
C	25W3
C	21WA4
C	27W2
D	47W1
D	24W7
D	36W4

Copyright FCJ

www.fciconnect.com		surface ISO 1302	tolerance std ISO 406 ISO 1101	projection mm
		TOLERANCES UNLESS OTHERWISE SPECIFIED		
Dr	M PESSON	2006/11/14	ANGULAR	0.X ±0.3
Eng	P LEGARE	2006/11/14	LINEAR	0.xx ±0.1
Chr	P LEGARE	2006/11/14	0° ±2°	0.xxx ±0.05
Appr	P LEGARE	2006/11/14	Product family	- Spec ref
FCJ SUB FEMALE DMW		cat no	C01-8637-1755	Rev. B
mixed power 3 level wire wrap		customer	sheet 2 of 7	

SCALE: 4

5W1

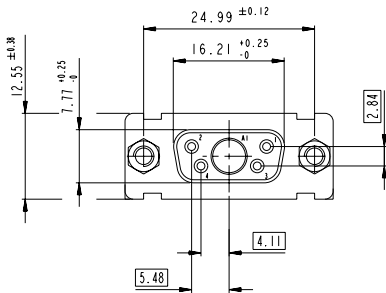
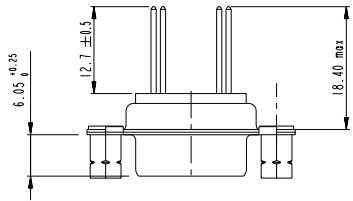
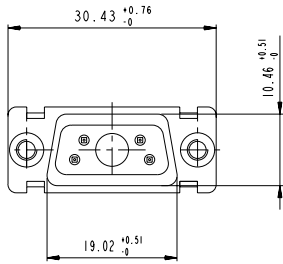

Floating signal contacts

11W1

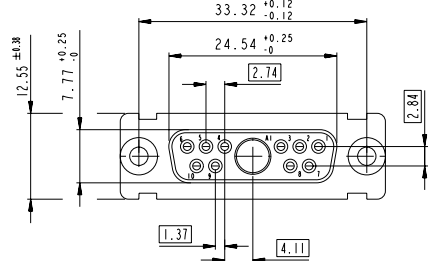
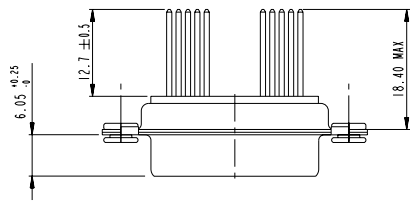
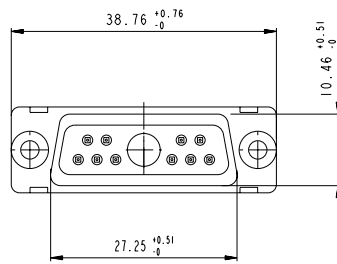

7W2

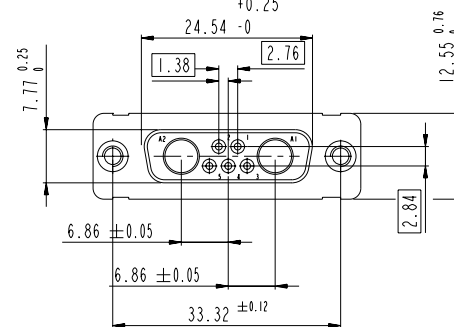
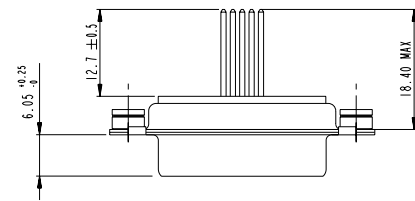
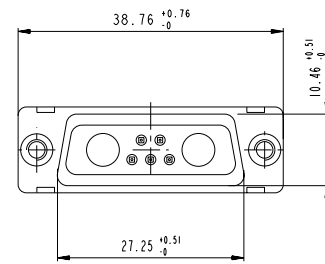

SIDE VIEW FOR LAYOUTS: E A B C

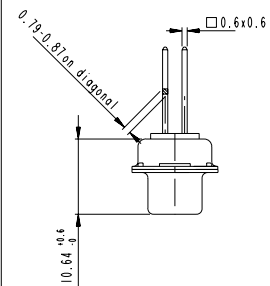

Copyright FCI.

www.fciconnect.com		surface ISO 1302	tolerance std ISO 406 ISO 1101	projection	mm
		TOLERANCES UNLESS OTHERWISE SPECIFIED			
Dr M PESSON	2006/11/14	ANGULAR	0.X ±0.3	size A2	Scale 2:1
Eng P LEGARE	2006/11/14	LINEAR	0.XX ±0.1	ECN	LS07-0273
Chr P LEGARE	2006/11/14	0° ±2°	0.XXX ±0.05	Product family	Spec ref
Appr P LEGARE	2006/11/14	Product family			
	SUB FEMALE DMW		cat no C01-8637-1755	Rev. B	
mixed power 3 level wire wrap		customer	sheet 3 of 7		

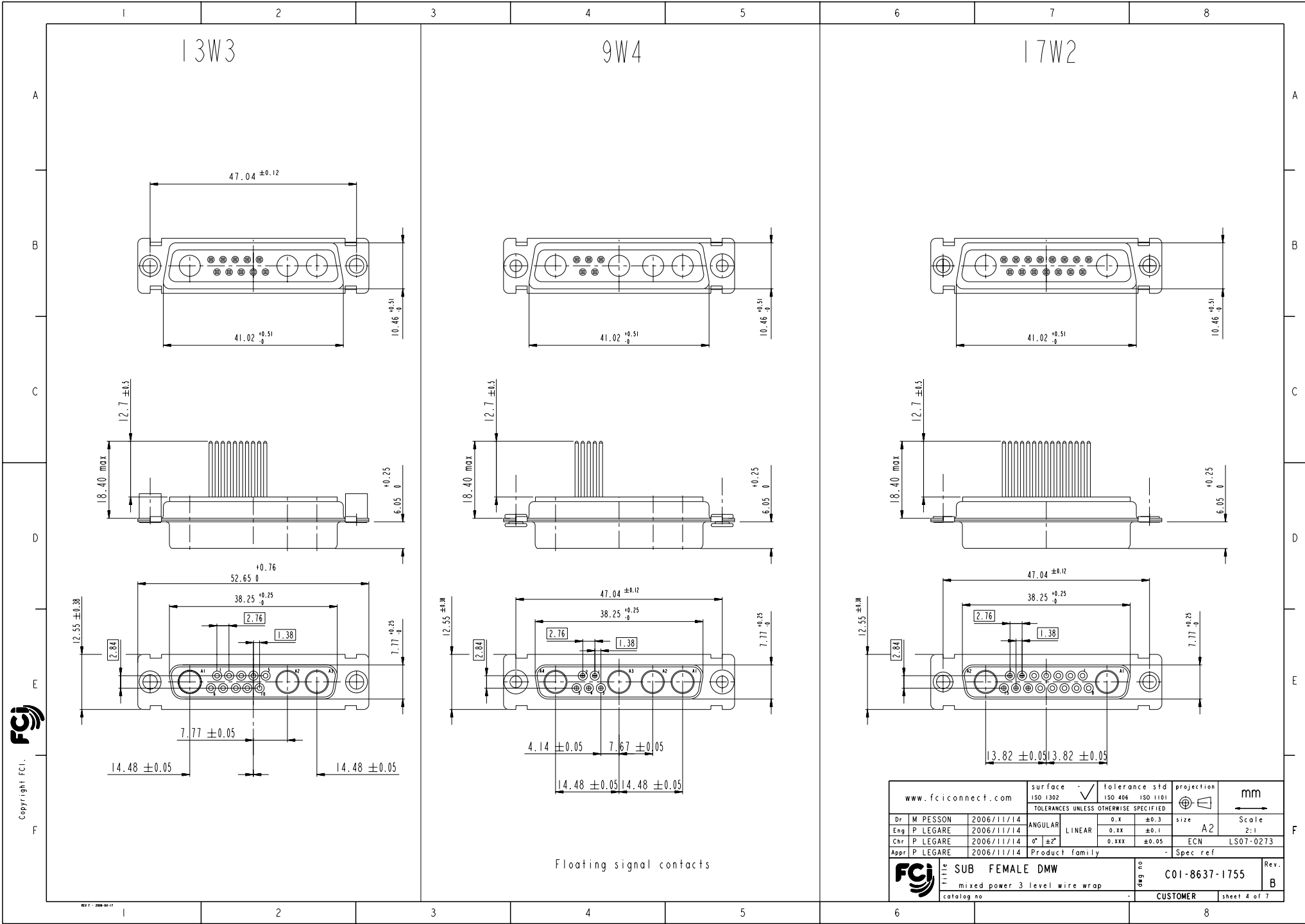

Floating signal contacts

www.fciconnect.com		surface - ✓ ISO 1302	tolerance std ISO 406 ISO 1101	projection mm	mm
		TOLERANCES UNLESS OTHERWISE SPECIFIED		size	Scale
Dr M PESSON	2006/11/14	ANGULAR	0.X ±0.3	A2	2:1
Eng P LEGARE	2006/11/14	LINEAR	0.XX ±0.1	ECN	LS07-0273
Chr P LEGARE	2006/11/14	0° ±2°	0.XXX ±0.05	Spec ref	
Appr P LEGARE	2006/11/14	Product family			
TITLE SUB FEMALE DMW mixed power 3 level wire wrap catalog no		ang no C01-8637-1755	Rev. B	CUSTOMER sheet 4 of 7	

Copyright FCJ.

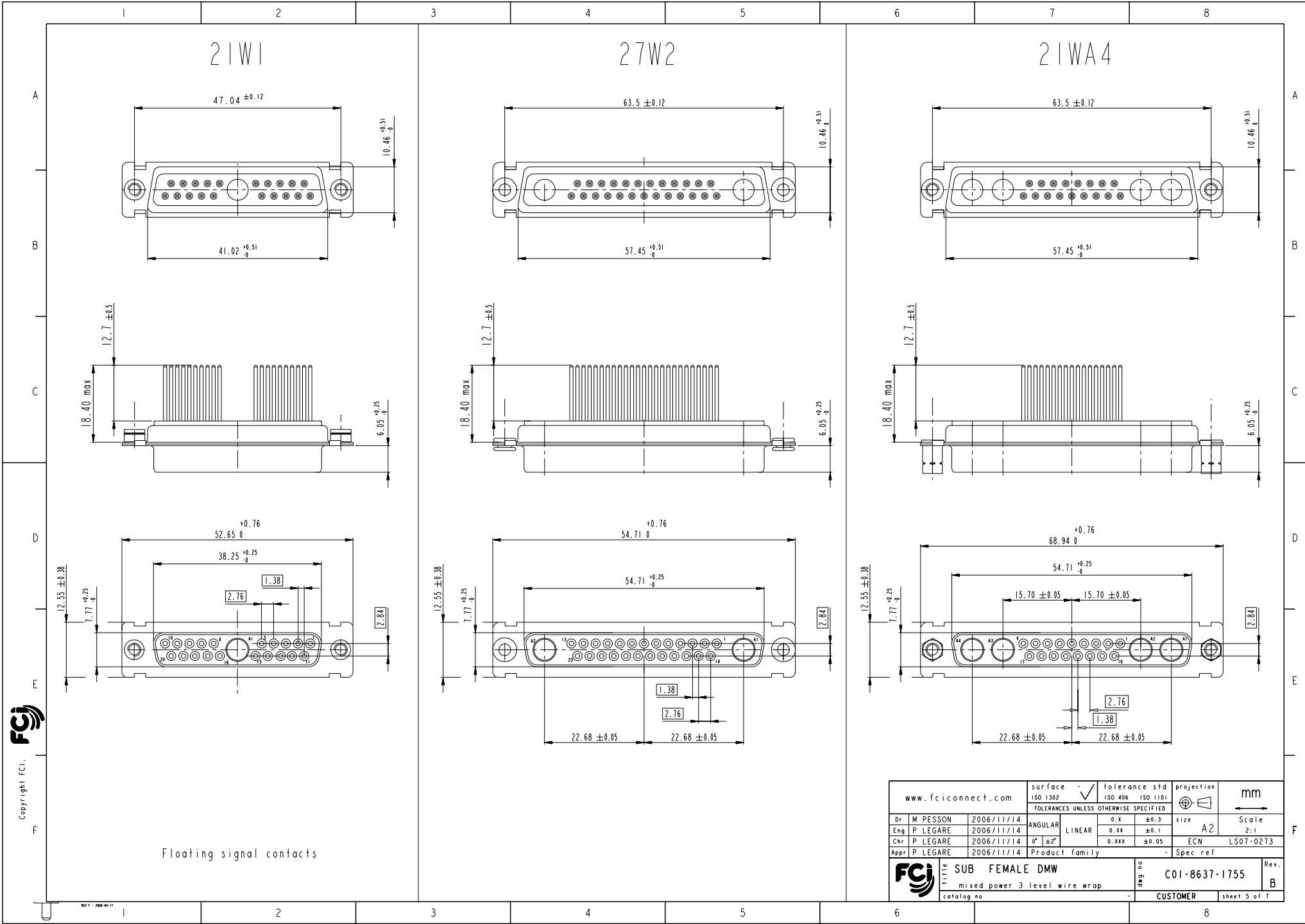

Floating signal contacts

www.fciconnect.com		surface -	tolerance std	projection	mm
		ISO 1302	ISO 406 ISO 1101		
		TOLERANCES UNLESS OTHERWISE SPECIFIED			
Dr	M PESSON	2006/11/14	ANGULAR	0.X ±0.3	size A2 Scale 2:1
Eng	P LEGARE	2006/11/14	LINEAR	0.XX ±0.1	
Chr	P LEGARE	2006/11/14	0° ±2°	0.XXX ±0.05	ECN LS07-0273
Appr	P LEGARE	2006/11/14	Product family	-	Spec ref
		SUB FEMALE DMW		ang no	Rev.
		mixed power 3 level wire wrap		C01-8637-1755	B
		catalog no	CUSTOMER	sheet 5 of 7	

Copyright FCI.

25W3

24W7

SIDE VIEW FOR
LAYOUT: D

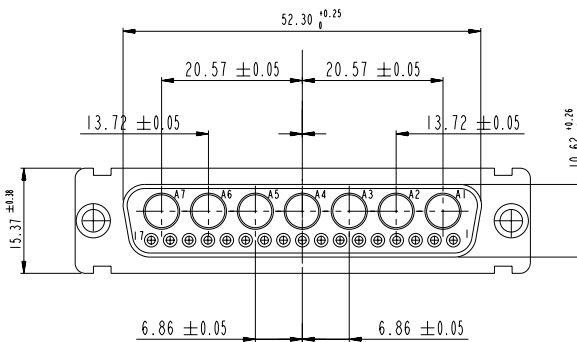
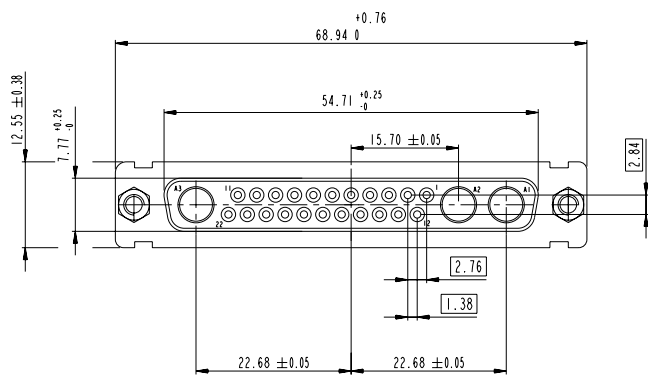
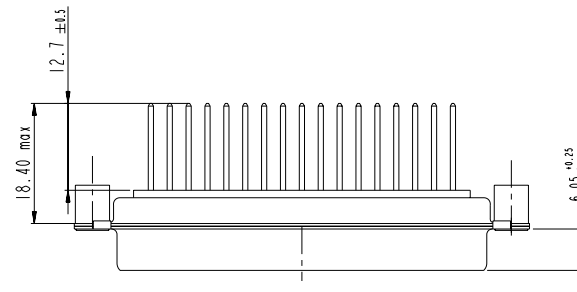
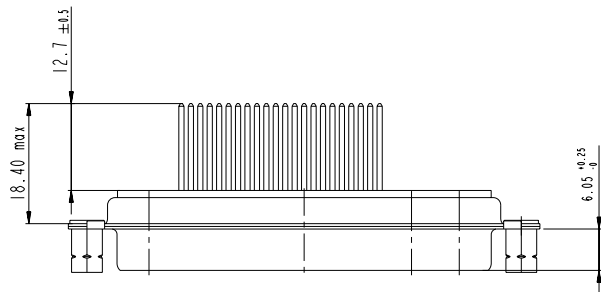
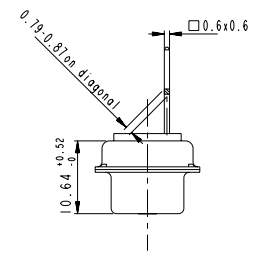
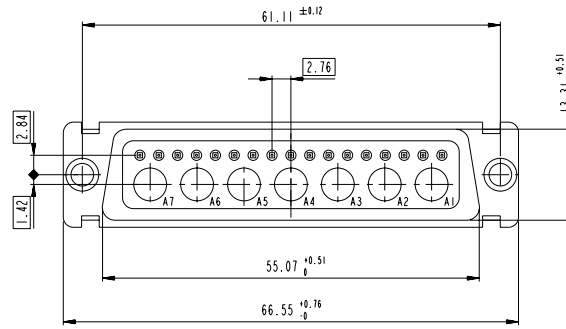
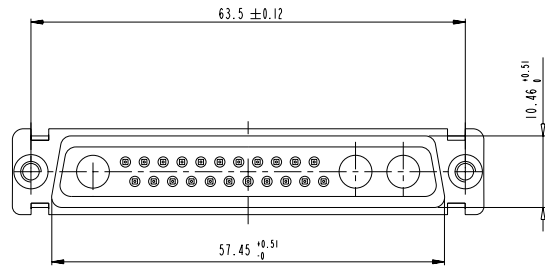

Copyright FCJ.

www.fciconnect.com		surface ISO 1302	tolerance std ISO 406 ISO 1101	projection mm
		TOLERANCES UNLESS OTHERWISE SPECIFIED		
Dr M PESSON	2006/11/14	ANGULAR	0.X ± 0.3	size A2 Scale 2:1
Eng P LEGARE	2006/11/14	LINEAR	0.XX ± 0.1	ECN LS07-0273
Chr P LEGARE	2006/11/14	0° ± 2°	0.XXX ± 0.05	Spec ref
Appr P LEGARE	2006/11/14	Product family		
SUB FEMALE DMW mixed power 3 level wire wrap catalog no		ang no C01-8637-1755	Rev. B	sheet 6 of 7

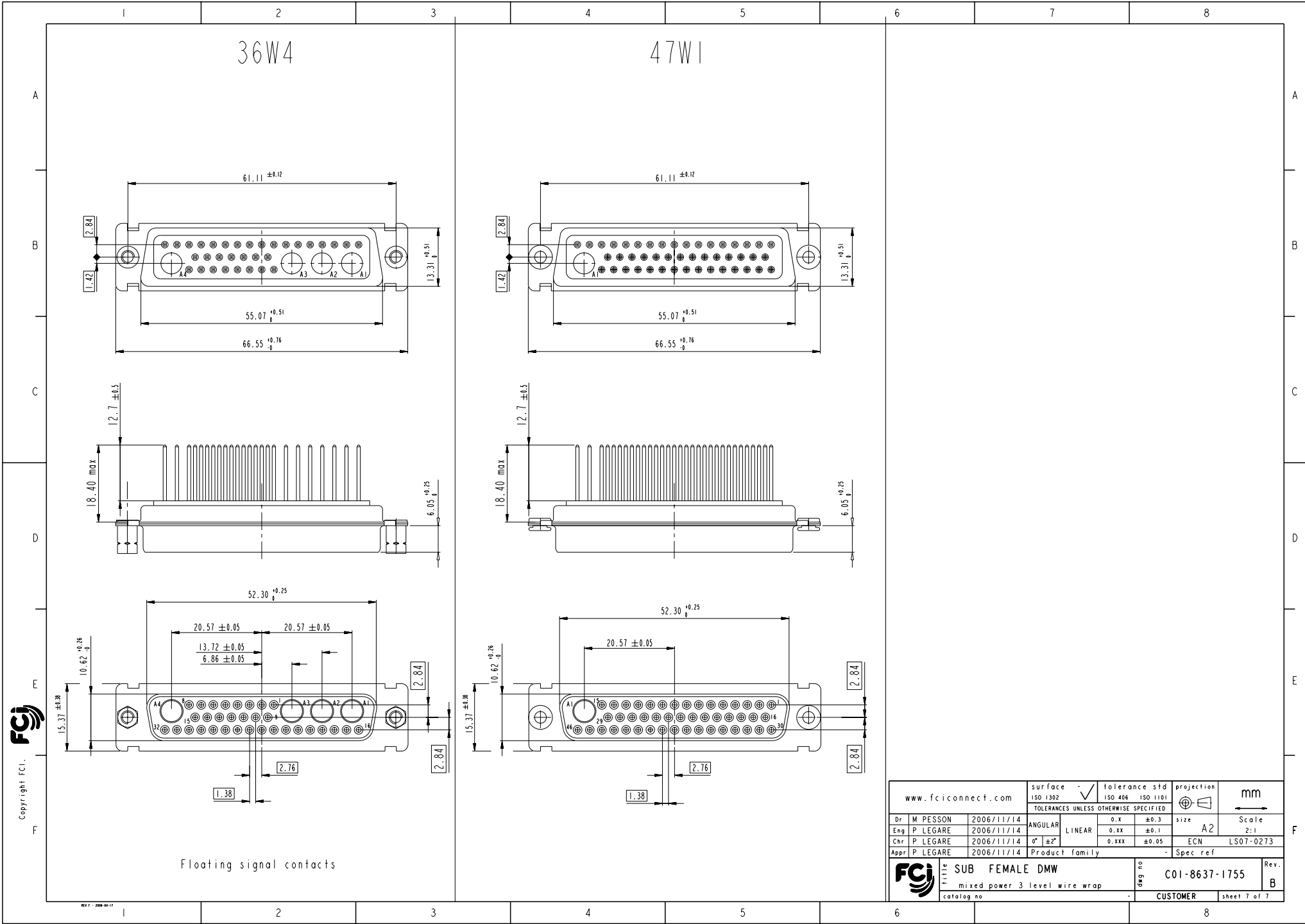

Floating signal contacts

www.fciconnect.com		surface ISO 1302	tolerance std ISO 406 ISO 1101	projection mm
		TOLERANCES UNLESS OTHERWISE SPECIFIED		
Dr	M PESSON	2006/11/14	ANGULAR	size A2
Eng	P LEGARE	2006/11/14	LINEAR	Scale 2:1
Chr	P LEGARE	2006/11/14	$0^\circ \pm 2'$	ECN LS07-0273
Appr	P LEGARE	2006/11/14	Product family	Spec ref
TITLE SUB FEMALE DMW mixed power 3 level wire wrap catalog no		dwg no C01-8637-1755 CUSTOMER	Rev. B	sheet 7 of 7



Компания «ЭлектроПласт» предлагает заключение долгосрочных отношений при поставках импортных электронных компонентов на взаимовыгодных условиях!

Наши преимущества:

- Оперативные поставки широкого спектра электронных компонентов отечественного и импортного производства напрямую от производителей и с крупнейших мировых складов;
- Поставка более 17-ти миллионов наименований электронных компонентов;
- Поставка сложных, дефицитных, либо снятых с производства позиций;
- Оперативные сроки поставки под заказ (от 5 рабочих дней);
- Экспресс доставка в любую точку России;
- Техническая поддержка проекта, помощь в подборе аналогов, поставка прототипов;
- Система менеджмента качества сертифицирована по Международному стандарту ISO 9001;
- Лицензия ФСБ на осуществление работ с использованием сведений, составляющих государственную тайну;
- Поставка специализированных компонентов (Xilinx, Altera, Analog Devices, Intersil, Interpoint, Microsemi, Aeroflex, Peregrine, Syfer, Eurofarad, Texas Instrument, Miteq, Cobham, E2V, MA-COM, Hittite, Mini-Circuits, General Dynamics и др.);

Помимо этого, одним из направлений компании «ЭлектроПласт» является направление «Источники питания». Мы предлагаем Вам помощь Конструкторского отдела:

- Подбор оптимального решения, техническое обоснование при выборе компонента;
- Подбор аналогов;
- Консультации по применению компонента;
- Поставка образцов и прототипов;
- Техническая поддержка проекта;
- Защита от снятия компонента с производства.



Как с нами связаться

Телефон: 8 (812) 309 58 32 (многоканальный)

Факс: 8 (812) 320-02-42

Электронная почта: org@eplast1.ru

Адрес: 198099, г. Санкт-Петербург, ул. Калинина, дом 2, корпус 4, литера А.