



Höchstzulässige Werte / Maximum rated values

Elektrische Eigenschaften / Electrical properties

Kollektor-Emitter-Sperrspannung collector-emitter voltage		V_{CES}	1200	V
Kollektor-Dauergleichstrom DC-collector current	$T_C = 80\text{ °C}$	$I_{C,nom.}$	35	A
	$T_C = 25\text{ °C}$	I_C	70	A
Periodischer Kollektor Spitzenstrom repetitive peak collector current	$t_p = 1\text{ ms}, T_C = 80\text{ °C}$	I_{CRM}	70	A
Gesamt-Verlustleistung total power dissipation	$T_C=25\text{ °C}, \text{ Transistor}$	P_{tot}	280	W
Gate-Emitter-Spitzenspannung gate-emitter peak voltage		V_{GES}	+/- 20V	V
Dauergleichstrom DC forward current		I_F	35	A
Periodischer Spitzenstrom repetitive peak forw. current	$t_p = 1\text{ ms}$	I_{FRM}	70	A
Grenzlastintegral der Diode I^2t - value, Diode	$V_R = 0V, t_p = 10\text{ms}, T_{vj} = 125\text{ °C}$	I^2t	400	A^2s
Isolations-Prüfspannung insulation test voltage	RMS, $f = 50\text{ Hz}, t = 1\text{ min.}$	V_{ISOL}	2,5	kV

Charakteristische Werte / Characteristic values

Transistor / Transistor

min. typ. max.

Kollektor-Emitter Sättigungsspannung collector-emitter saturation voltage	$I_C = 35A, V_{GE} = 15V, T_{vj} = 25\text{ °C}$	$V_{CE\ sat}$	-	2,1	2,6	V
	$I_C = 35A, V_{GE} = 15V, T_{vj} = 125\text{ °C}$		-	2,4	2,9	V
Gate-Schwellenspannung gate threshold voltage	$I_C = 1,2mA, V_{CE} = V_{GE}, T_{vj} = 25\text{ °C}$	$V_{GE(th)}$	4,5	5,5	6,5	V
Gateladung gate charge	$V_{GE} = -15V...+15V$	Q_G	-	0,35	-	μC
Eingangskapazität input capacitance	$f = 1MHz, T_{vj} = 25\text{ °C}, V_{CE} = 25V, V_{GE} = 0V$	C_{ies}	-	2	-	nF
Rückwirkungskapazität reverse transfer capacitance	$f = 1MHz, T_{vj} = 25\text{ °C}, V_{CE} = 25V, V_{GE} = 0V$	C_{res}	-	0,13	-	nF
Kollektor-Emitter Reststrom collector-emitter cut-off current	$V_{CE} = 1200V, V_{GE} = 0V, T_{vj} = 25\text{ °C}$	I_{CES}	-	2	80	μA
	$V_{CE} = 1200V, V_{GE} = 0V, T_{vj} = 125\text{ °C}$		-	200	-	μA
Gate-Emitter Reststrom gate-emitter leakage current	$V_{CE} = 0V, V_{GE} = 20V, T_{vj} = 25\text{ °C}$	I_{GES}	-	-	400	nA

prepared by: Mark Münzer

date of publication: 9.9.1999

approved by: M. Hierholzer

revision: 2



Charakteristische Werte / Characteristic values

Transistor / Transistor		min.	typ.	max.		
Einschaltverzögerungszeit (ind. Last) turn on delay time (inductive load)	$I_C = 35A, V_{CC} = 600V$	$t_{d,on}$	-	0,05	-	μs
	$V_{GE} = \pm 15V, R_G = 22\Omega, T_{vj} = 25^\circ C$			0,06	-	μs
Anstiegszeit (induktive Last) rise time (inductive load)	$I_C = 35A, V_{CC} = 600V$	t_r	-	0,05	-	μs
	$V_{GE} = \pm 15V, R_G = 22\Omega, T_{vj} = 125^\circ C$			0,05	-	μs
Abschaltverzögerungszeit (ind. Last) turn off delay time (inductive load)	$I_C = 35A, V_{CC} = 600V$	$t_{d,off}$	-	0,25	-	μs
	$V_{GE} = \pm 15V, R_G = 22\Omega, T_{vj} = 125^\circ C$			0,3	-	μs
Fallzeit (induktive Last) fall time (inductive load)	$I_C = 35A, V_{CC} = 600V$	t_f	-	0,03	-	μs
	$V_{GE} = \pm 15V, R_G = 22\Omega, T_{vj} = 125^\circ C$			0,07	-	μs
Einschaltverlustenergie pro Puls turn-on energy loss per pulse	$I_C = 35A, V_{CC} = 600V, V_{GE} = 15V$ $R_G = 22\Omega, T_{vj} = 125^\circ C, L_S = 120nH$	E_{on}	-	4,5	-	mWs
Abschaltverlustenergie pro Puls turn-off energy loss per pulse	$I_C = 35A, V_{CC} = 600V, V_{GE} = 15V$ $R_G = 22\Omega, T_{vj} = 125^\circ C, L_S = 120nH$	E_{off}	-	4,3	-	mWs
Kurzschlußverhalten SC Data	$t_F \leq 10\mu sec, V_{GE} \leq 15V, R_G = 22\Omega$ $T_{vj} \leq 125^\circ C, V_{CC} = 900V, V_{CEmax} = V_{CES} - L_{sCE} \cdot di/dt$	I_{SC}	-	320	-	A
Modulinduktivität stray inductance module		L_{sCE}	-	60	-	nH
Modul Leitungswiderstand, Anschlüsse – Chip module lead resistance, terminals – chip	$T_C = 25^\circ C$	R_{CC+EE}	-	8,0	-	m Ω

Charakteristische Werte / Characteristic values

Diode / Diode		min.	typ.	max.		
Durchlaßspannung forward voltage	$I_F = 35A, V_{GE} = 0V, T_{vj} = 25^\circ C$	V_F	-	1,8	2,3	V
	$I_F = 35A, V_{GE} = 0V, T_{vj} = 125^\circ C$			1,7	2,2	V
Rückstromspitze peak reverse recovery current	$I_F = 35A, -di_F/dt = 900A/\mu sec$	I_{RM}	-	36	-	A
	$V_R = 600V, V_{GE} = -15V, T_{vj} = 25^\circ C$ $V_R = 600V, V_{GE} = -15V, T_{vj} = 125^\circ C$			45	-	A
Sperrverzögerungsladung recovered charge	$I_F = 35A, -di_F/dt = 900A/\mu sec$	Q_r	-	3,6	-	μAs
	$V_R = 600V, V_{GE} = -15V, T_{vj} = 25^\circ C$ $V_R = 600V, V_{GE} = -15V, T_{vj} = 125^\circ C$			7,6	-	μAs
Abschaltenergie pro Puls reverse recovery energy	$I_F = 35A, -di_F/dt = 900A/\mu sec$	E_{rec}	-	1,3	-	mWs
	$V_R = 600V, V_{GE} = -15V, T_{vj} = 25^\circ C$ $V_R = 600V, V_{GE} = -15V, T_{vj} = 125^\circ C$			2,8	-	mWs



Thermische Eigenschaften / Thermal properties

			min.	typ.	max.	
Innerer Wärmewiderstand thermal resistance, junction to case	Transistor / transistor, DC	R_{thJC}	-	-	0,44	K/W
	Diode/Diode, DC		-	-	0,8	K/W
Übergangs-Wärmewiderstand thermal resistance, case to heatsink	pro Modul / per module $\lambda_{Paste} = 1 \text{ W/m} \cdot \text{K}$ / $\lambda_{grease} = 1 \text{ W/m} \cdot \text{K}$	R_{thCK}	-	0,02	-	K/W
Höchstzulässige Sperschichttemperatur maximum junction temperature		T_{vj}	-	-	150	°C
Betriebstemperatur operation temperature		T_{op}	-40	-	125	°C
Lagertemperatur storage temperature		T_{stg}	-40	-	150	°C

Mechanische Eigenschaften / Mechanical properties

Gehäuse, siehe Anlage case, see appendix					
Innere Isolation internal insulation				AL ₂ O ₃	
CTI comperative tracking index				225	
Anzugsdrehmoment f. mech. Befestigung mounting torque		M1	3	6	Nm
Anzugsdrehmoment f. elektr. Anschlüsse terminal connection torque		M2			Nm
Gewicht weight		G		180	g

Mit dieser technischen Information werden Halbleiterbauelemente spezifiziert, jedoch keine Eigenschaften zugesichert. Sie gilt in Verbindung mit den zugehörigen Technischen Erläuterungen.

This technical information specifies semiconductor devices but promises no characteristics. It is valid in combination with the belonging technical notes.



Ausgangskennlinie (typisch)
Output characteristic (typical)

$I_C = f(V_{CE})$
 $V_{GE} = 15V$

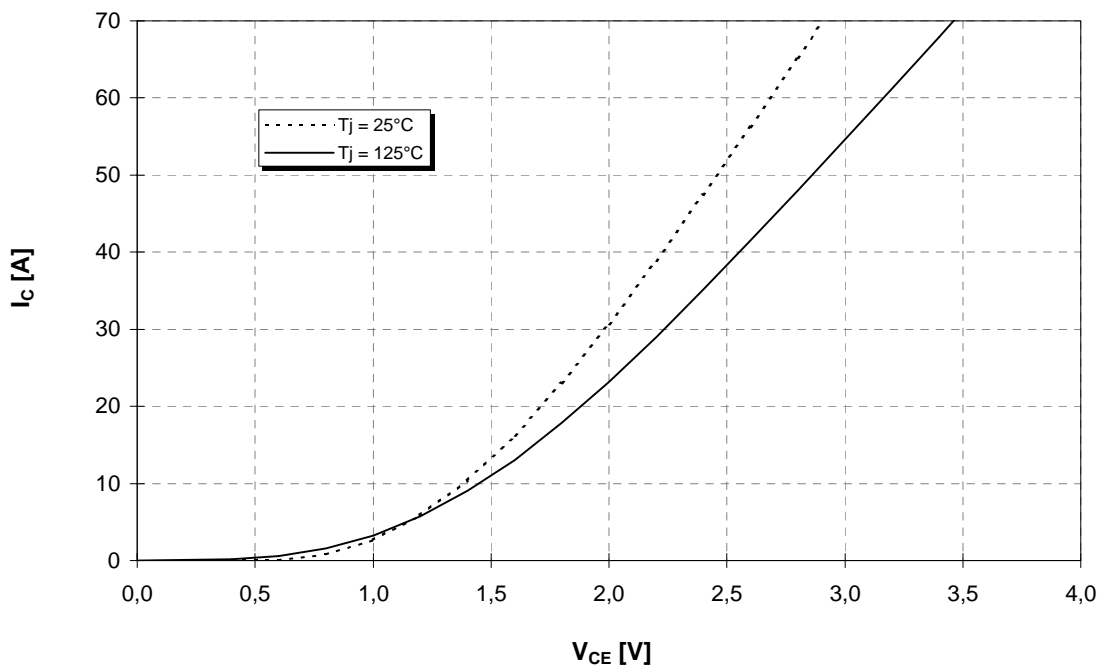

Ausgangskennlinienfeld (typisch)
Output characteristic (typical)

$I_C = f(V_{CE})$
 $T_{vj} = 125°C$

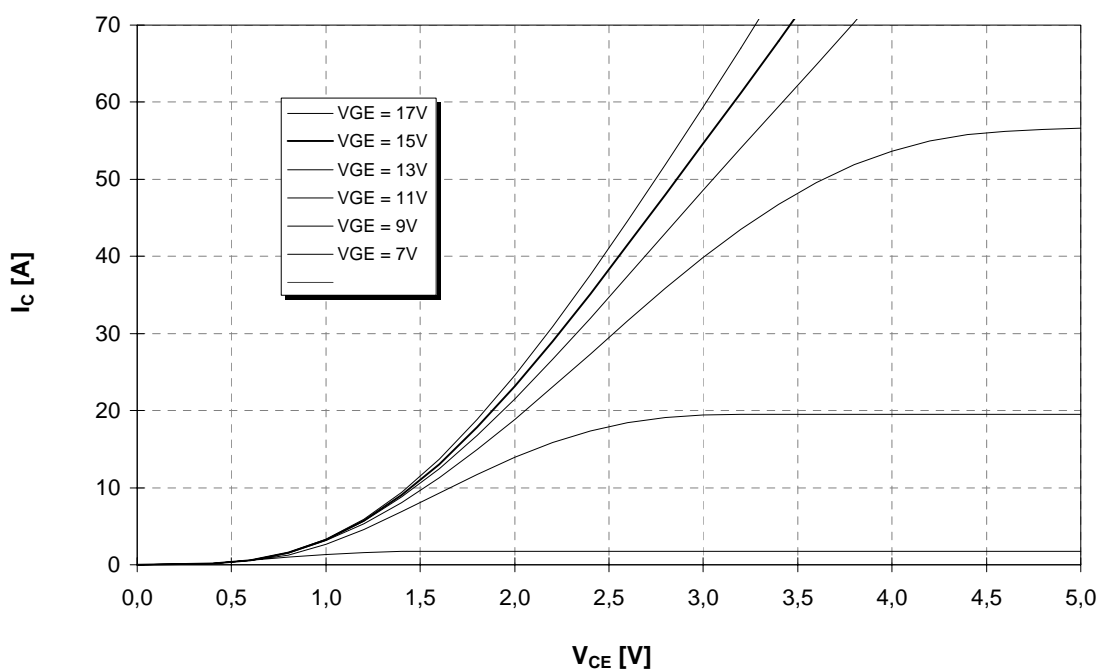



Übertragungscharakteristik (typisch)
Transfer characteristic (typical)

$I_C = f(V_{GE})$
 $V_{CE} = 20V$

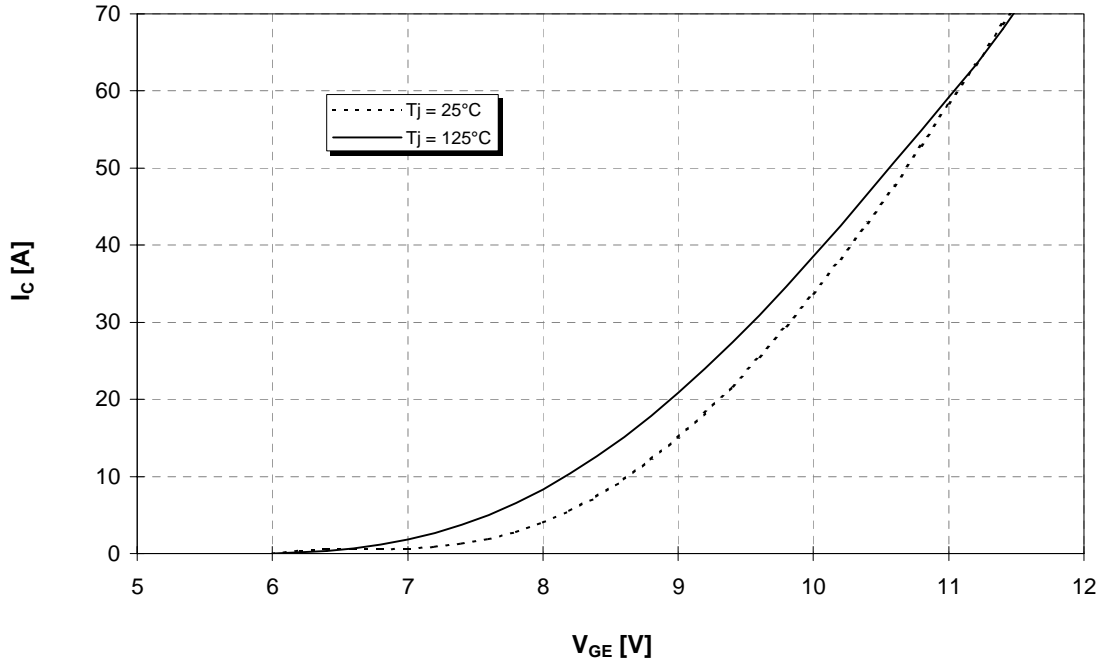

Durchlaßkennlinie der Inversdiode (typisch)
Forward characteristic of inverse diode (typical)

$I_F = f(V_F)$

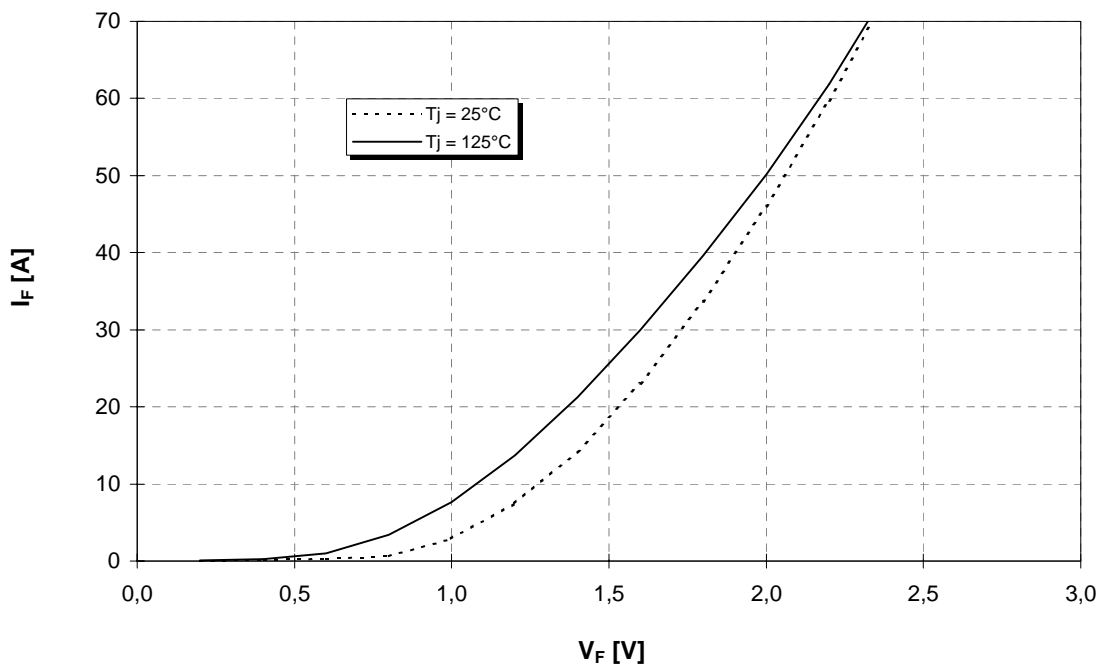



Schaltverluste (typisch) $E_{on} = f(I_C)$, $E_{off} = f(I_C)$, $E_{rec} = f(I_C)$
Switching losses (typical) $V_{GE}=15V$, $R_{gon} = R_{goff}=22 \Omega$, $V_{CE} = 600V$, $T_j = 125^\circ C$

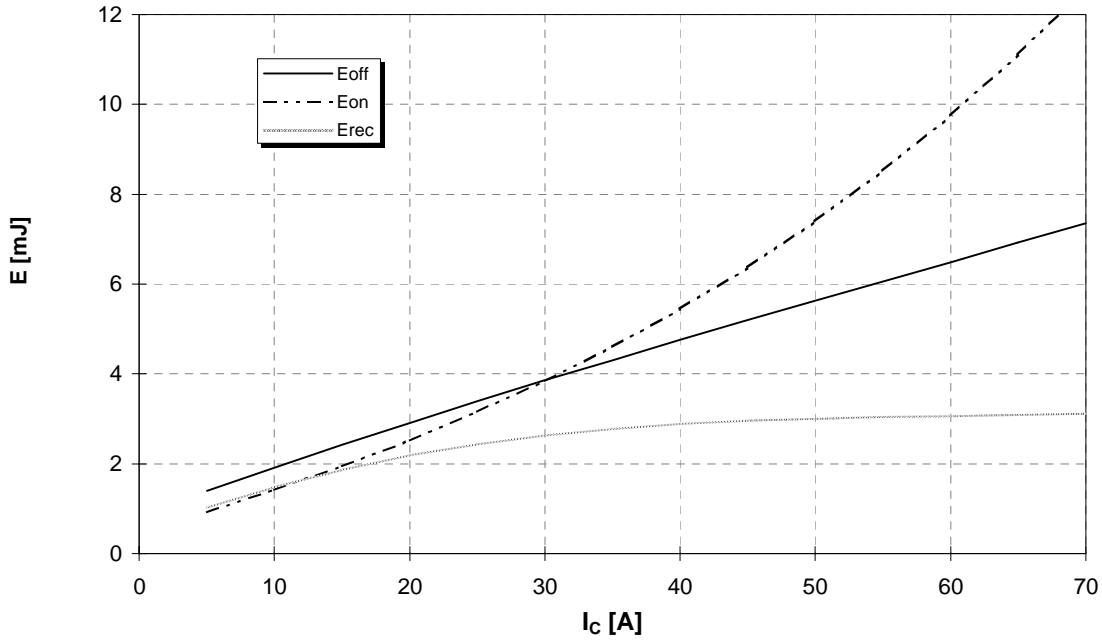

Schaltverluste (typisch) $E_{on} = f(R_G)$, $E_{off} = f(R_G)$, $E_{rec} = f(R_G)$
Switching losses (typical) $V_{GE}=15V$, $I_C = 35A$, $V_{CE} = 600V$, $T_j = 125^\circ C$

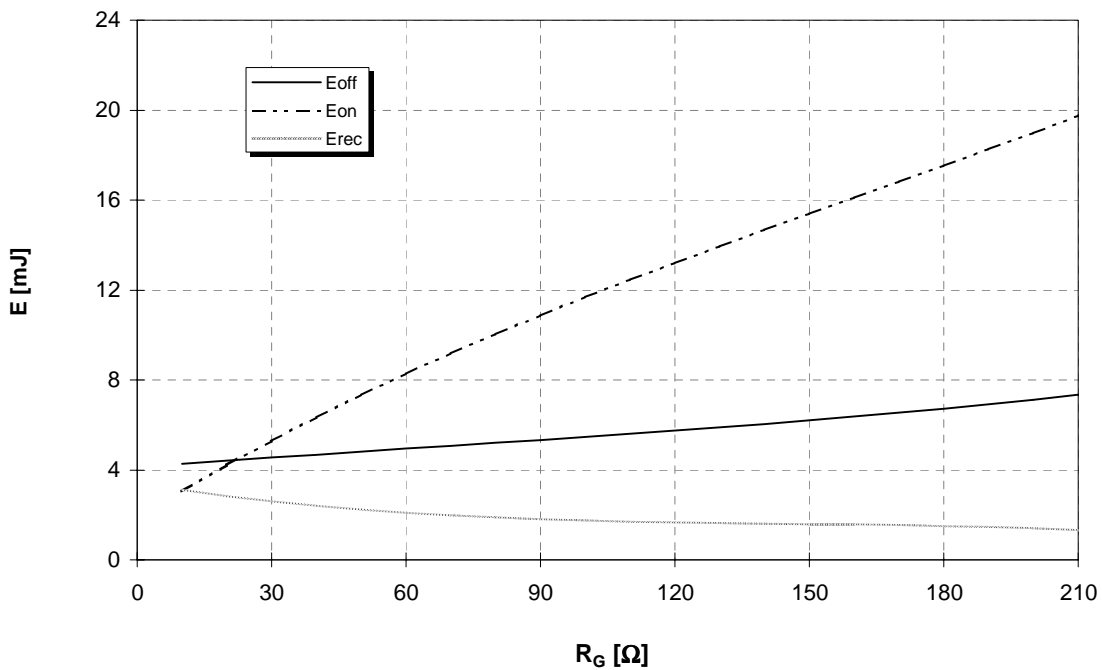



**Transienter Wärmewiderstand
Transient thermal impedance**

$Z_{thJC} = f(t)$

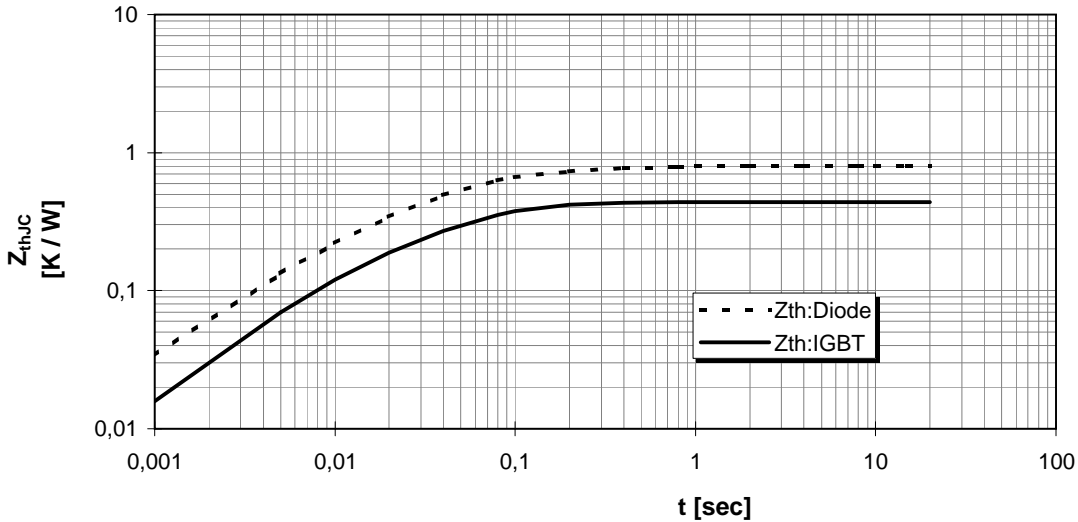

i	1	2	3	4
r_i [K/kW] : IGBT	85,88	289,11	22,94	42,06
τ_i [sec] : IGBT	0,009	0,045	0,073	0,229
r_i [K/kW] : Diode	47,398	348,913	310,298	93,392
τ_i [sec] : Diode	0,003	0,022	0,064	0,344

Sicherer Arbeitsbereich (RBSOA)

Reverse bias safe operation area (RBSOA)

$V_{GE} = 15V, R_g = 22 \text{ Ohm}, T_{vj} = 125^\circ C$

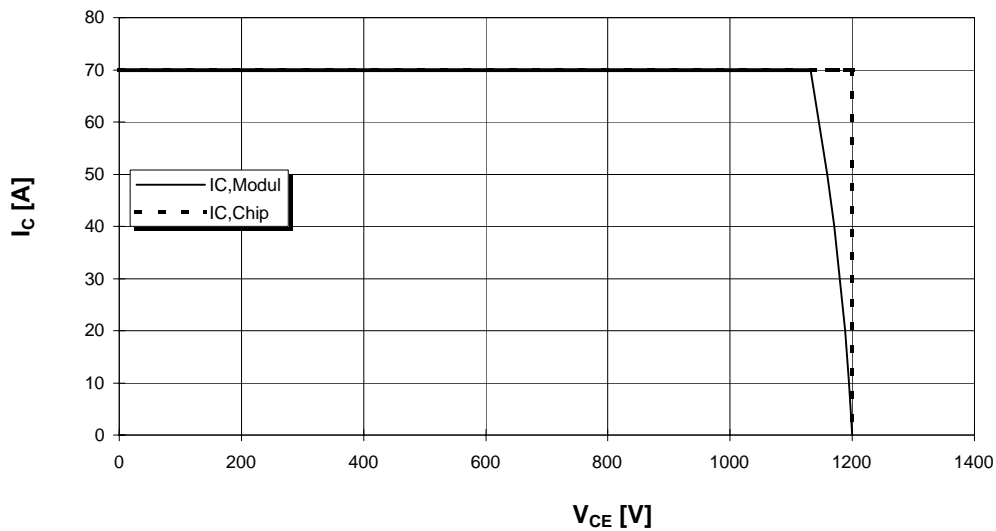



Econo 2 (shortpin)

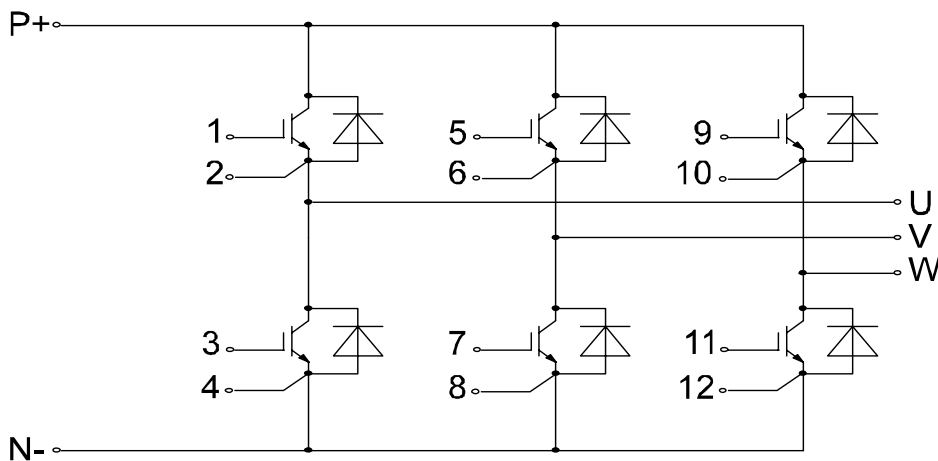
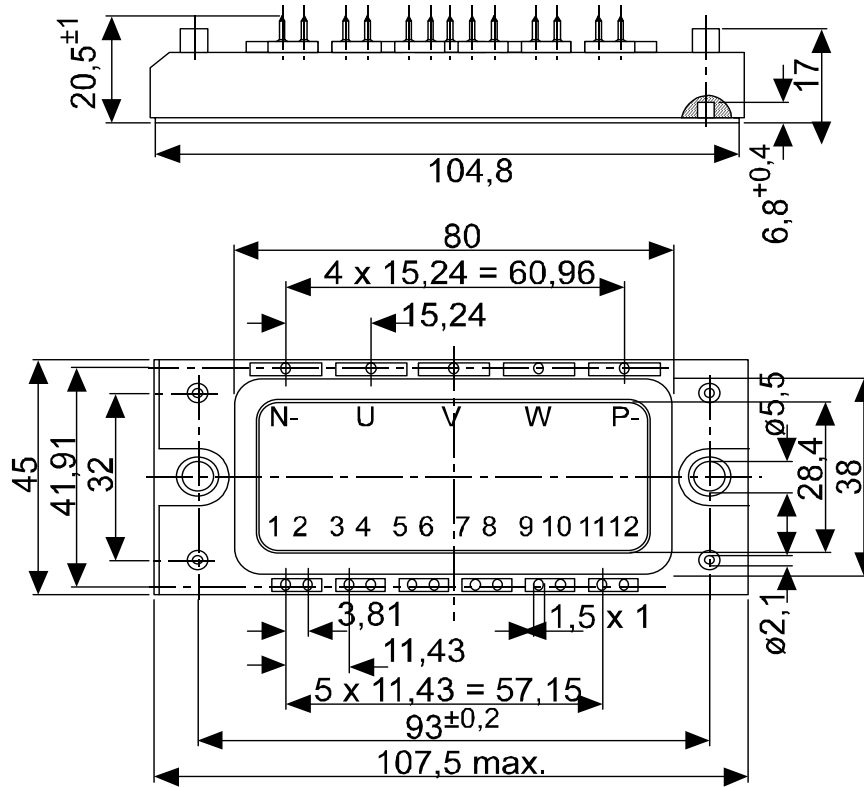



Компания «ЭлектроПласт» предлагает заключение долгосрочных отношений при поставках импортных электронных компонентов на взаимовыгодных условиях!

Наши преимущества:

- Оперативные поставки широкого спектра электронных компонентов отечественного и импортного производства напрямую от производителей и с крупнейших мировых складов;
- Поставка более 17-ти миллионов наименований электронных компонентов;
- Поставка сложных, дефицитных, либо снятых с производства позиций;
- Оперативные сроки поставки под заказ (от 5 рабочих дней);
- Экспресс доставка в любую точку России;
- Техническая поддержка проекта, помощь в подборе аналогов, поставка прототипов;
- Система менеджмента качества сертифицирована по Международному стандарту ISO 9001;
- Лицензия ФСБ на осуществление работ с использованием сведений, составляющих государственную тайну;
- Поставка специализированных компонентов (Xilinx, Altera, Analog Devices, Intersil, Interpoint, Microsemi, Aeroflex, Peregrine, Syfer, Eurofarad, Texas Instrument, Miteq, Cobham, E2V, MA-COM, Hittite, Mini-Circuits, General Dynamics и др.);

Помимо этого, одним из направлений компании «ЭлектроПласт» является направление «Источники питания». Мы предлагаем Вам помощь Конструкторского отдела:

- Подбор оптимального решения, техническое обоснование при выборе компонента;
- Подбор аналогов;
- Консультации по применению компонента;
- Поставка образцов и прототипов;
- Техническая поддержка проекта;
- Защита от снятия компонента с производства.



Как с нами связаться

Телефон: 8 (812) 309 58 32 (многоканальный)

Факс: 8 (812) 320-02-42

Электронная почта: org@eplast1.ru

Адрес: 198099, г. Санкт-Петербург, ул. Калинина, дом 2, корпус 4, литера А.