



Micro Commercial Components



Micro Commercial Components
20736 Marilla Street Chatsworth
CA 91311
Phone: (818) 701-4933
Fax: (818) 701-4939

SM4001PL thru SM4007PL

1.0 Ampere Silicon Rectifier 50 to 1000 Volts

Features

- Lead Free Finish/Rohs Compliant (Note1) ("P" Suffix designates Compliant. See ordering information)
- Low Leakage Current
- Glass Passivated Junction
- Halogen free available upon request by adding suffix "-HF"
- Epoxy meets UL 94 V-0 flammability rating
- Moisture Sensitivity Level 1

Maximum Ratings

- Operating Temperature(T_J): -65°C to +175°C
- Storage Temperature(T_{STG}): -65°C to +175°C
- Typical Thermal Resistance(R_{thJA}): 50°C/W

MCC Part Number	Device Marking	Maximum Recurrent Peak Reverse Voltage	Maximum RMS Voltage	Maximum DC Blocking Voltage
SM4001PL	A1	50V	35V	50V
SM4002PL	A2	100V	70V	100V
SM4003PL	A3	200V	140V	200V
SM4004PL	A4	400V	280V	400V
SM4005PL	A5	600V	420V	600V
SM4006PL	A6	800V	560V	800V
SM4007PL	A7	1000V	700V	1000V

Electrical Characteristics @ 25°C Unless Otherwise Specified

Average Forward Current	I _{F(AV)}	1.0 A	T _A = 75°C
Peak Forward Surge Current	I _{FSM}	25A	8.3ms, half sine
Maximum Instantaneous Forward Voltage	V _F	1.1V	T _A = 25°C I _F =1A
Maximum DC Reverse Current At Rated DC Blocking Voltage	I _R	5.0μA 50uA	T _A = 25°C T _A =100 °C
Maximum Full Load Reverse Current Average ,Full Cycle 9.5mm Lead Length	I _R	30uA	T _L =75 °C
Typical Junction Capacitance	C _J	15pF	Measured at 1.0MHz, V _R =4.0V

Note: 1. High Temperature Solder Exemptions Applied, see EU Directive Annex 7.

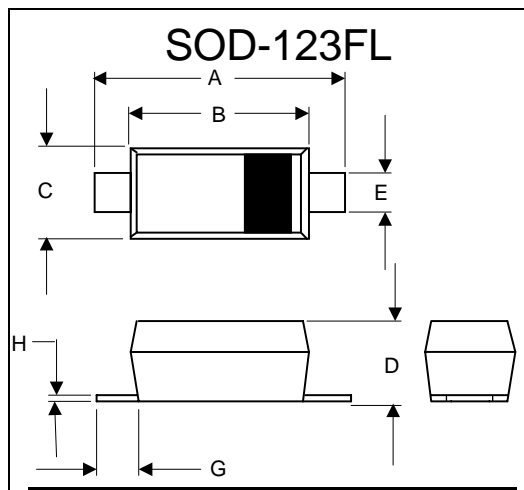

DIM	DIMENSIONS				NOTE
	INCHES		MM		
	MIN	MAX	MIN	MAX	
A	.140	.152	3.55	3.85	
B	.100	.122	2.55	3.10	
C	.055	.075	1.40	1.90	
D	.035	.053	0.90	1.35	
E	.020	.041	0.50	1.05	
G	.010	-----	0.25	-----	
H	-----	.010	----	.25	

SUGGESTED SOLDER PAD LAYOUT

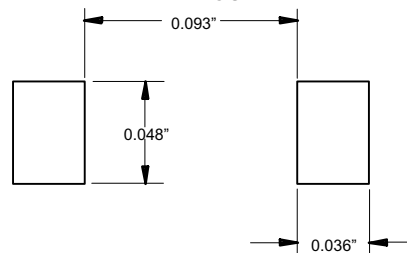

SM4001PL thru SM4007PL



Micro Commercial Components

Figure 1
Typical Forward Characteristics

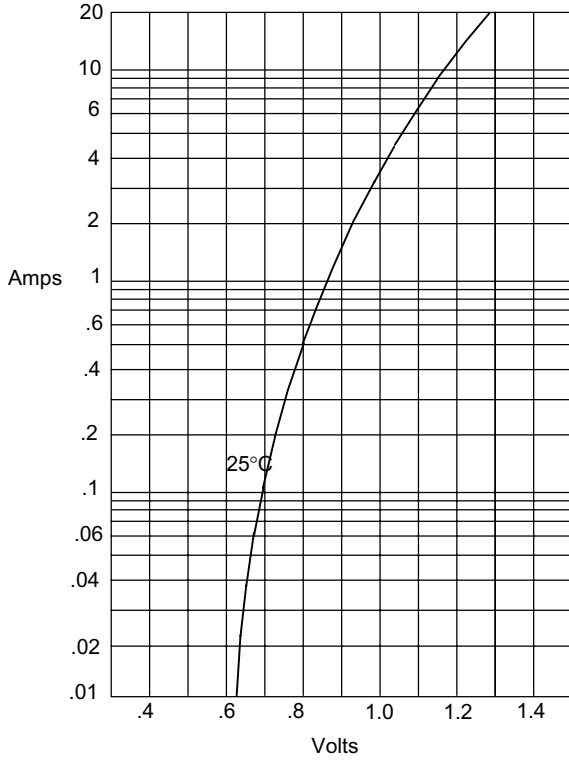

Instantaneous Forward Current - Amperes versus
Instantaneous Forward Voltage - Volts

Figure 2
Forward Derating Curve

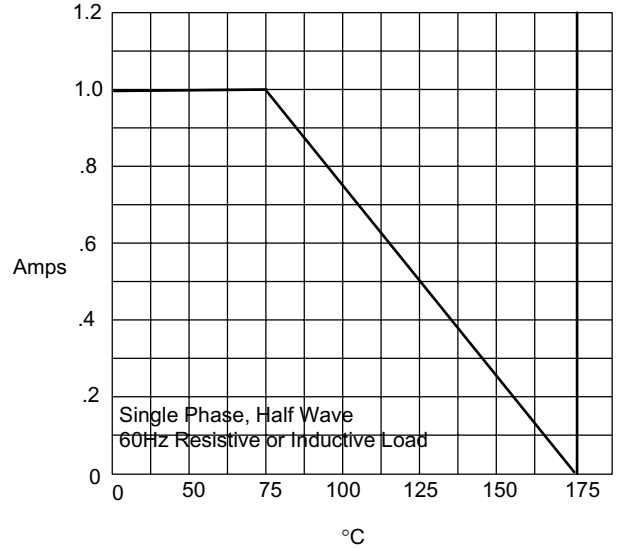

Average Forward Rectified Current - Amperes versus
Ambient Temperature - °C

Figure 3
Junction Capacitance

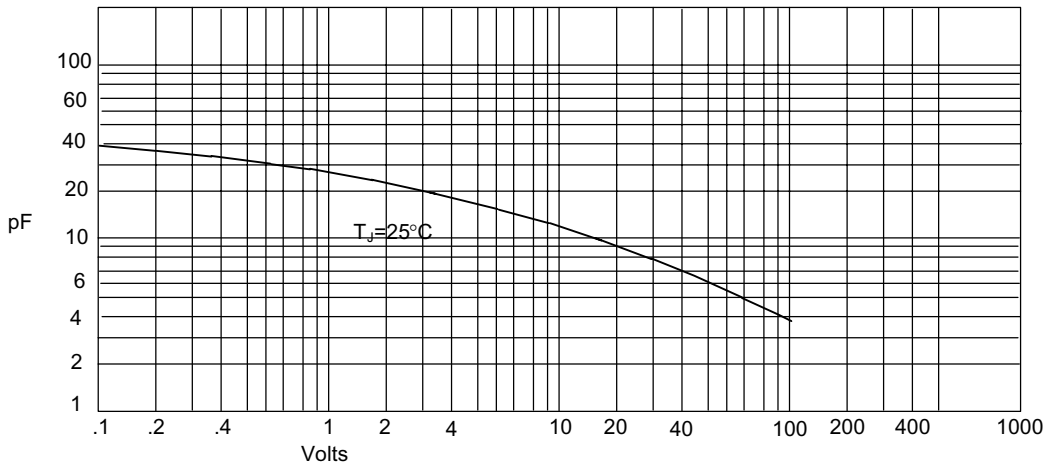

Junction Capacitance - pF versus
Reverse Voltage - Volts

SM4001PL thru SM4007PL

Figure 4
Typical Reverse Characteristics

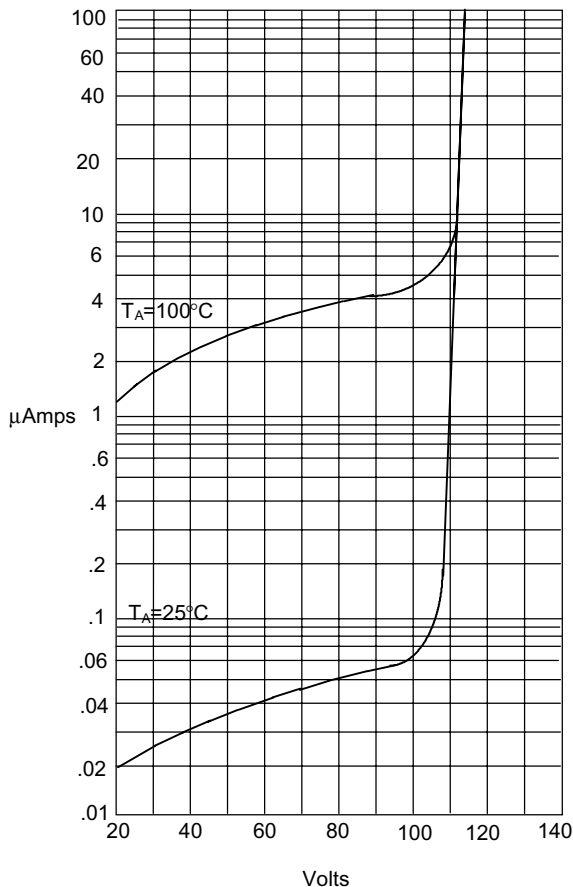

Instantaneous Reverse Leakage Current - MicroAmperes versus
Percent Of Rated Peak Reverse Voltage - Volts

Figure 5
Peak Forward Surge Current

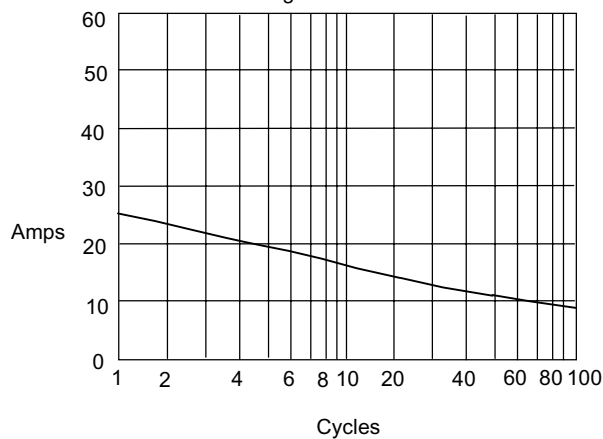

Peak Forward Surge Current - Amperes versus
Number Of Cycles At 60Hz - Cycles



TM

Micro Commercial Components

Ordering Information :

Device	Packing
Part Number-TP	Tape&Reel: 2.5Kpcs/Reel

Note : Adding "-HF" suffix for halogen free, eg. Part Number-TP-HF

IMPORTANT NOTICE

Micro Commercial Components Corp. reserves the right to make changes without further notice to any product herein to make corrections, modifications , enhancements , improvements , or other changes . **Micro Commercial Components Corp .** does not assume any liability arising out of the application or use of any product described herein; neither does it convey any license under its patent rights ,nor the rights of others . The user of products in such applications shall assume all risks of such use and will agree to hold **Micro Commercial Components Corp .** and all the companies whose products are represented on our website, harmless against all damages.

LIFE SUPPORT

MCC's products are not authorized for use as critical components in life support devices or systems without the express written approval of Micro Commercial Components Corporation.

CUSTOMER AWARENESS

Counterfeiting of semiconductor parts is a growing problem in the industry. Micro Commercial Components (MCC) is taking strong measures to protect ourselves and our customers from the proliferation of counterfeit parts. MCC strongly encourages customers to purchase MCC parts either directly from MCC or from Authorized MCC Distributors who are listed by country on our web page cited below. Products customers buy either from MCC directly or from Authorized MCC Distributors are genuine parts, have full traceability, meet MCC's quality standards for handling and storage. **MCC will not provide any warranty coverage or other assistance for parts bought from Unauthorized Sources.** MCC is committed to combat this global problem and encourage our customers to do their part in stopping this practice by buying direct or from authorized distributors.



Компания «ЭлектроПласт» предлагает заключение долгосрочных отношений при поставках импортных электронных компонентов на взаимовыгодных условиях!

Наши преимущества:

- Оперативные поставки широкого спектра электронных компонентов отечественного и импортного производства напрямую от производителей и с крупнейших мировых складов;
- Поставка более 17-ти миллионов наименований электронных компонентов;
- Поставка сложных, дефицитных, либо снятых с производства позиций;
- Оперативные сроки поставки под заказ (от 5 рабочих дней);
- Экспресс доставка в любую точку России;
- Техническая поддержка проекта, помощь в подборе аналогов, поставка прототипов;
- Система менеджмента качества сертифицирована по Международному стандарту ISO 9001;
- Лицензия ФСБ на осуществление работ с использованием сведений, составляющих государственную тайну;
- Поставка специализированных компонентов (Xilinx, Altera, Analog Devices, Intersil, Interpoint, Microsemi, Aeroflex, Peregrine, Syfer, Eurofarad, Texas Instrument, Miteq, Cobham, E2V, MA-COM, Hittite, Mini-Circuits, General Dynamics и др.);

Помимо этого, одним из направлений компании «ЭлектроПласт» является направление «Источники питания». Мы предлагаем Вам помощь Конструкторского отдела:

- Подбор оптимального решения, техническое обоснование при выборе компонента;
- Подбор аналогов;
- Консультации по применению компонента;
- Поставка образцов и прототипов;
- Техническая поддержка проекта;
- Защита от снятия компонента с производства.



Как с нами связаться

Телефон: 8 (812) 309 58 32 (многоканальный)

Факс: 8 (812) 320-02-42

Электронная почта: org@eplast1.ru

Адрес: 198099, г. Санкт-Петербург, ул. Калинина, дом 2, корпус 4, литера А.