150 mA Low Voltage Dual-Channel LDO Regulator with Sequence Control

NO.EA-200-160707

OUTLINE

The RP152x is a 150 mA dual-channel LDO regulator that provides high ripple rejection, low dropout voltage, high output voltage accuracy, and low supply current. Internally, the RP152x consists of a voltage reference unit, an error amplifier, resistors for setting output voltage, a short current limit circuit, and a chip enable circuit. Moreover, the RP152xxxxC consists of a start-up sequence circuit.

The RP152x is available in fixed output voltage options. Besides the low supply current by CMOS, the RP152x offers a low dropout voltage by built-in low ON resistance r_{ON} as well as an extended battery life by a chip enable function. Compared with the existing CMOS-based regulators, the RP152x is further improved in ripple rejection, line transient response, and load transient response. All these features allow the RP152x to become ideal power sources for hand-held communication equipment.

The RP152x is offered in a 6-pin SOT-23-6 package and a 6-pin DFN1212-6 package. Both packages are equipped with two LDOs which can achieve high-density mounting.

FEATURES

- Supply Current Typ. 40 μ A x 2
- Standby Current Typ. 0.1 μ A x 2
- Ripple Rejection Typ. 70 dB, f = 1 kHz
- Input Voltage Range 1.4 V to 5.25 V
- Output Voltage Range 0.8 V to 3.6 V, 0.1 V step
- Output Voltage Accuracy $\pm 1.0\%$, $V_{SET} > 2.0$ V, $T_a = 25^\circ$ C
- Temperature-Drift Coefficient of Output Voltage Typ. ± 80 ppm/ $^\circ$ C
- Dropout Voltage Typ. 0.20 V, $I_{OUT} = 150$ mA, $V_{SET} = 2.8$ V
- Line Regulation Typ. 0.02%/V
- Packages DFN1212-6, SOT-23-6
- Short-current Limit Typ. 40 mA
- Ceramic Capacitor Compatible 0.22 μ F or more

APPLICATIONS

- Battery-powered Equipment
- Portable Communication Equipment, Cameras
- Home Electrical Appliances

RP152x

NO.EA-200-160707

SELECTION GUIDE

The set output voltage, the package type, the auto-discharge function¹ and the start-up sequence control are user-selectable options.

Selection Guide

Product Name	Package	Quantity per Reel	Pb Free	Halogen Free
RP152Lxxx*-TR	DFN1212-6	5,000 pcs	Yes	Yes
RP152Nxxx*-TR-FE	SOT-23-6	3,000 pcs	Yes	Yes

xxx: Specify the combination of set output voltage (V_{SET}) within the range of 0.8 V to 3.6 V in 0.1 V step.

*: Specify the auto-discharge function and the start-up sequence control.

(A) Auto-discharge function not included

(B) Auto-discharge function included

(C) Start-up sequence control and Auto-discharge function included

¹ Auto-discharge function quickly lowers the output voltage to 0 V by releasing the electrical charge accumulated in the external capacitor when the chip enable signal is switched from the active mode to the standby mode.

BLOCK DIAGRAMS



RP152xxxxA Block Diagram



RP152xxxxB Block Diagram



RP152xxxxC Block Diagram

RP152x

NO.EA-200-160707

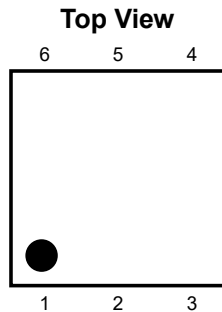
PIN DESCRIPTIONS**DFN1212-6 Pin Configuration****SOT-23-6 Pin Configuration****DFN1212-6 Pin Description**

Pin No.	Symbol	Description
1	VOUT1	Output Pin 1
2	VOUT2	Output Pin2
3	GND	Ground Pin
4	CE2	Chip Enable Pin 2, Active-high
5	VDD	Input Pin
6	CE1	Chip Enable Pin 1, Active-high

* The tab on the bottom of the package enhances thermal performance and is electrically connected to GND (substrate level). It is recommended that the tab be connected to the ground plane on the board, or otherwise be left floating.

SOT-23-6 Pin Description

Pin No.	Symbol	Description
1	CE1	Chip Enable Pin 1, Active-high
2	VDD	Input Pin
3	CE2	Chip Enable Pin 2, Active-high
4	VOUT2	Output Pin2
5	GND	Ground Pin
6	VOUT1	Output Pin 1

ABSOLUTE MAXIMUM RATINGS

Absolute Maximum Ratings

Symbol	Item	Rating	Unit	
V_{IN}	Input Voltage	-0.3 to 6.0	V	
V_{CE}	CE Pin Input Voltage	-0.3 to 6.0	V	
V_{OUT1} V_{OUT2}	Output Voltage	-0.3 to $V_{IN}+0.3$	V	
I_{OUT1} I_{OUT2}	Output Current	180	mA	
P_D	Power Dissipation (Standard Land Pattern) ¹	DFN1212-6	600	mW
		SOT-23-6	420	
T_j	Junction Temperature	-40 to 125	°C	
T_{stg}	Storage Temperature Range	-55 to 125	°C	

ABSOLUTE MAXIMUM RATINGS

Electronic and mechanical stress momentarily exceeded absolute maximum ratings may cause the permanent damages and may degrade the life time and safety for both device and system using the device in the field. The functional operation at or over these absolute maximum ratings is not assured.

RECOMMENDED OPERATING CONDITIONS

Recommended Operating Conditions

Symbol	Item	Rating	Unit
V_{IN}	Input Voltage ²	1.40 to 5.25	V
T_a	Operating Temperature Range	-40 to 85	°C

RECOMMENDED OPERATING CONDITIONS

All of electronic equipment should be designed that the mounted semiconductor devices operate within the recommended operating conditions. The semiconductor devices cannot operate normally over the recommended operating conditions, even if when they are used over such conditions by momentary electronic noise or surge. And the semiconductor devices may receive serious damage when they continue to operate over the recommended operating conditions.

¹ Refer to *POWER DISSIPATION* in *SUPPLEMENTARY ITEMS* for detailed information.

² In case of operating the device beyond 5.25 V, do not exceed 5.5 V with 500 total operating hours.

RP152x

NO.EA-200-160707

ELECTRICAL CHARACTERISTICS

$V_{IN} = V_{SET} + 1.0 \text{ V}$ ($V_{SET} > 1.5 \text{ V}$), $V_{IN} = 2.5 \text{ V}$ ($V_{SET} \leq 1.5 \text{ V}$), $I_{OUT} = 1 \text{ mA}$, $C_{IN} = C_{OUT} = 0.22 \mu\text{F}$, unless otherwise noted.

The specifications surrounded by are guaranteed by Design Engineering at $-40^\circ\text{C} \leq T_a \leq 85^\circ\text{C}$.

RP152x Electrical Characteristics

($T_a = 25^\circ\text{C}$)

Symbol	Item	Conditions		Min.	Typ.	Max.	Unit
V_{OUT}	Output Voltage	$T_a = 25^\circ\text{C}$	$V_{SET} > 2.0 \text{ V}$	$\times 0.99$		$\times 1.01$	V
			$V_{SET} \leq 2.0 \text{ V}$	-20		20	mV
		$-40^\circ\text{C} \leq T_a \leq 85^\circ\text{C}$	$V_{SET} > 2.0 \text{ V}$	×0.97		×1.03	V
			$V_{SET} \leq 2.0 \text{ V}$	-60		60	mV
I_{OUT}	Output Current		150			mA	
$\frac{\Delta V_{OUT}}{\Delta I_{OUT}}$	Load Regulation	$1 \text{ mA} \leq I_{OUT} \leq 150 \text{ mA}$		Refer to Product-specific Electrical Characteristics			
V_{DIF}	Dropout Voltage	$I_{OUT} = 150 \text{ mA}$					
I_{SS}	Supply Current	$I_{OUT} = 0 \text{ mA}$			40	60	μA
Istandby	Standby Current	$V_{CE} = 0 \text{ V}$			0.1	1.0	μA
$\frac{\Delta V_{OUT}}{\Delta V_{IN}}$	Line Regulation	$V_{SET} + 0.5 \text{ V} \leq V_{IN} \leq 5.0 \text{ V}$			0.02	0.10	%/V
RR	Ripple Rejection	f = 1 kHz, Ripple 0.2 Vp-p $V_{IN} = V_{SET} + 1.0 \text{ V}$, $I_{OUT} = 30 \text{ mA}$ Notes: $V_{IN} = 3.0 \text{ V}$ when $V_{SET} \leq 2.0 \text{ V}$			70		dB
$\frac{\Delta V_{OUT}}{\Delta T_a}$	Output Voltage Temperature Coefficient	$-40^\circ\text{C} \leq T_a \leq 85^\circ\text{C}$			± 80		ppm/ $^\circ\text{C}$
I_{SC}	Short Current Limit	$V_{SET} = 0 \text{ V}$			40		mA
I_{PD}	CE Pull-down Current				0.3		μA
V_{CEH}	CE Input Voltage "H"			1.0			V
V_{CEL}	CE Input Voltage "L"					0.4	V
en	Output Noise	BW = 10 Hz to 100 kHz			60		μVrms
R_{LOW}	Low Output Nch Tr. ON Resistance (RP152xxxxB/C)	$V_{IN} = 4.0 \text{ V}$, $V_{CE} = 0 \text{ V}$	RP152xxxxC (VR2)		10		Ω
			Others		50		

All test items listed under *ELECTRICAL CHARACTERISTICS* are done under the pulse load condition ($T_j \approx T_a = 25^\circ\text{C}$) except for Output Noise, Ripple Rejection and Output Voltage Temperature Coefficient.

Product-specific Electrical Characteristics VOUT1

Product Name	V _{OUT1} (Ta = 25°C)			V _{OUT1} (-40°C ≤ Ta ≤ 85°C)			ΔV _{OUT1} /ΔI _{OUT}		V _{DIF1}	
	Min.	Typ.	Max.	Min.	Typ.	Max.	Typ.	Max.	Typ.	Max.
RP152x001x	2.772	2.800	2.828	2.716	2.800	2.884	15	60	0.200	0.350
RP152x002x	1.780	1.800	1.820	1.740	1.800	1.860	15	55	0.270	0.460
RP152x003x	1.480	1.500	1.520	1.440	1.500	1.560	15	50	0.310	0.550
RP152x004x	1.180	1.200	1.220	1.140	1.200	1.260	15	50	0.390	0.620
RP152x005x	3.267	3.300	3.333	3.201	3.300	3.399	15	60	0.190	0.320
RP152x006x	3.267	3.300	3.333	3.201	3.300	3.399	15	60	0.190	0.320
RP152x007x	2.822	2.850	2.879	2.765	2.850	2.936	15	60	0.200	0.350
RP152x008x	2.822	2.850	2.879	2.765	2.850	2.936	15	60	0.200	0.350
RP152x009x	2.970	3.000	3.030	2.910	3.000	3.090	15	60	0.190	0.320
RP152x010x	2.970	3.000	3.030	2.910	3.000	3.090	15	60	0.190	0.320
RP152x011x	1.780	1.800	1.820	1.740	1.800	1.860	15	55	0.270	0.460
RP152x012x	2.772	2.800	2.828	2.716	2.800	2.884	15	60	0.200	0.350
RP152x013x	3.267	3.300	3.333	3.201	3.300	3.399	15	60	0.190	0.320
RP152x014x	3.267	3.300	3.333	3.201	3.300	3.399	15	60	0.190	0.320
RP152x015x	1.480	1.500	1.520	1.440	1.500	1.560	15	50	0.310	0.550
RP152x016x	1.480	1.500	1.520	1.440	1.500	1.560	15	50	0.310	0.550
RP152x017x	2.475	2.500	2.525	2.425	2.500	2.575	15	60	0.200	0.350
RP152x018x	1.780	1.800	1.820	1.740	1.800	1.860	15	55	0.270	0.460
RP152x019x	1.480	1.500	1.520	1.440	1.500	1.560	15	50	0.310	0.550
RP152x020x	2.772	2.800	2.828	2.716	2.800	2.884	15	60	0.200	0.350
RP152x021x	1.180	1.200	1.220	1.140	1.200	1.260	15	50	0.390	0.620
RP152x022x	2.772	2.800	2.828	2.716	2.800	2.884	15	60	0.200	0.350
RP152x023x	2.475	2.500	2.525	2.425	2.500	2.575	15	60	0.200	0.350
RP152x024x	3.267	3.300	3.333	3.201	3.300	3.399	15	60	0.190	0.320
RP152x025x	2.970	3.000	3.030	2.910	3.000	3.090	15	60	0.190	0.320
RP152x026x	2.772	2.800	2.828	2.716	2.800	2.884	15	60	0.200	0.350
RP152x027x	2.277	2.300	2.323	2.231	2.300	2.369	15	60	0.230	0.390
RP152x028x	2.772	2.800	2.828	2.716	2.800	2.884	15	60	0.200	0.350
RP152x029x	1.480	1.500	1.520	1.440	1.500	1.560	15	50	0.310	0.550
RP152x030x	1.480	1.500	1.520	1.440	1.500	1.560	15	50	0.310	0.550
RP152x031x	1.780	1.800	1.820	1.740	1.800	1.860	15	55	0.270	0.460
RP152x032x	1.180	1.200	1.220	1.140	1.200	1.260	15	50	0.390	0.620
RP152x033x	3.069	3.100	3.131	3.007	3.100	3.193	15	60	0.190	0.320
RP152x034x	1.780	1.800	1.820	1.740	1.800	1.860	15	55	0.270	0.460
RP152x035x	2.475	2.500	2.525	2.425	2.500	2.575	15	60	0.200	0.350
RP152x036x	1.180	1.200	1.220	1.140	1.200	1.260	15	50	0.390	0.620
RP152x037x	3.267	3.300	3.333	3.201	3.300	3.399	15	60	0.190	0.320
RP152x038x	1.180	1.200	1.220	1.140	1.200	1.260	15	50	0.390	0.620
RP152x039x	2.079	2.100	2.121	2.037	2.100	2.163	15	60	0.230	0.390
RP152x040x	2.772	2.800	2.828	2.716	2.800	2.884	15	60	0.200	0.350

RP152x

NO.EA-200-160707

Product-specific Electrical Characteristics VOUT1 (continued)

Product Name	V _{OUT1} (T _a = 25°C)			V _{OUT1} (-40°C ≤ T _a ≤ 85°C)			ΔV _{OUT1} / ΔI _{OUT}		V _{DIF1}	
	Min.	Typ.	Max.	Min.	Typ.	Max.	Typ.	Max.	Typ.	Max.
RP152x041x	1.780	1.800	1.820	1.740	1.800	1.860	15	55	0.270	0.460
RP152x042x	1.180	1.200	1.220	1.140	1.200	1.260	15	50	0.390	0.620
RP152x043x	1.280	1.300	1.320	1.240	1.300	1.360	15	50	0.390	0.620
RP152x044x	1.080	1.100	1.120	1.040	1.100	1.160	15	50	0.440	0.720
RP152x045x	2.772	2.800	2.828	2.716	2.800	2.884	15	60	0.200	0.350
RP152x046x	2.772	2.800	2.828	2.716	2.800	2.884	15	60	0.200	0.350
RP152x047x	2.475	2.500	2.525	2.425	2.500	2.575	15	60	0.200	0.350
RP152x048x	2.475	2.500	2.525	2.425	2.500	2.575	15	60	0.200	0.350
RP152x049x	1.480	1.500	1.520	1.440	1.500	1.560	15	50	0.310	0.550
RP152x050x	2.376	2.400	2.424	2.328	2.400	2.472	15	60	0.230	0.390
RP152x051x	0.980	1.000	1.020	0.940	1.000	1.060	10	40	0.440	0.720
RP152x052x	1.780	1.800	1.820	1.740	1.800	1.860	15	55	0.270	0.460
RP152x053x	2.574	2.600	2.626	2.522	2.600	2.678	15	60	0.200	0.350
RP152x054x	2.475	2.500	2.525	2.425	2.500	2.575	15	60	0.200	0.350
RP152x055x	2.970	3.000	3.030	2.910	3.000	3.090	15	60	0.190	0.320
RP152x056x	2.574	2.600	2.626	2.522	2.600	2.678	15	60	0.200	0.350
RP152x057x	3.069	3.100	3.131	3.007	3.100	3.193	15	60	0.190	0.320
RP152x058x	0.880	0.900	0.920	0.840	0.900	0.960	10	40	0.500	0.800
RP152x059x	2.871	2.900	2.929	2.813	2.900	2.987	15	60	0.200	0.350
RP152x060x	1.180	1.200	1.212	1.140	1.200	1.260	15	50	0.390	0.620
RP152x061x	1.780	1.800	1.820	1.740	1.800	1.860	15	55	0.270	0.460
RP152x062x	2.475	2.500	2.525	2.425	2.500	2.575	15	60	0.200	0.350

Product-specific Electrical Characteristics VOUT2

Product Name	V _{OUT2} (Ta = 25°C)			V _{OUT2} (-40°C ≤ Ta ≤ 85°C)			ΔV _{OUT2} / ΔI _{OUT}		V _{DIF2}	
	Min.	Typ.	Max.	Min.	Typ.	Max.	Typ.	Max.	Typ.	Max.
RP152x001x	2.772	2.800	2.828	2.716	2.800	2.884	15	60	0.200	0.350
RP152x002x	2.772	2.800	2.828	2.716	2.800	2.884	15	60	0.200	0.350
RP152x003x	2.772	2.800	2.828	2.716	2.800	2.884	15	60	0.200	0.350
RP152x004x	1.780	1.800	1.820	1.740	1.800	1.860	15	55	0.270	0.460
RP152x005x	1.180	1.200	1.220	1.140	1.200	1.260	15	50	0.390	0.620
RP152x006x	1.780	1.800	1.820	1.740	1.800	1.860	15	55	0.270	0.460
RP152x007x	2.822	2.850	2.879	2.765	2.850	2.936	15	60	0.200	0.350
RP152x008x	2.574	2.600	2.626	2.522	2.600	2.678	15	60	0.200	0.350
RP152x009x	2.772	2.800	2.828	2.716	2.800	2.884	15	60	0.200	0.350
RP152x010x	1.780	1.800	1.820	1.740	1.800	1.860	15	55	0.270	0.460
RP152x011x	1.480	1.500	1.520	1.440	1.500	1.560	15	50	0.310	0.550
RP152x012x	2.574	2.600	2.626	2.522	2.600	2.678	15	60	0.200	0.350
RP152x013x	2.772	2.800	2.828	2.716	2.800	2.884	15	60	0.200	0.350
RP152x014x	3.267	3.300	3.333	3.201	3.300	3.399	15	60	0.190	0.320
RP152x015x	2.475	2.500	2.525	2.425	2.500	2.575	15	60	0.200	0.350
RP152x016x	2.970	3.000	3.030	2.910	3.000	3.090	15	60	0.190	0.320
RP152x017x	2.970	3.000	3.030	2.910	3.000	3.090	15	60	0.190	0.320
RP152x018x	1.780	1.800	1.820	1.740	1.800	1.860	15	55	0.270	0.460
RP152x019x	2.574	2.600	2.626	2.522	2.600	2.678	15	60	0.200	0.350
RP152x020x	1.780	1.800	1.820	1.740	1.800	1.860	15	55	0.270	0.460
RP152x021x	2.772	2.800	2.828	2.716	2.800	2.884	15	60	0.200	0.350
RP152x022x	1.180	1.200	1.220	1.140	1.200	1.260	15	50	0.390	0.620
RP152x023x	2.475	2.500	2.525	2.425	2.500	2.575	15	60	0.200	0.350
RP152x024x	2.970	3.000	3.030	2.910	3.000	3.090	15	60	0.190	0.320
RP152x025x	2.970	3.000	3.030	2.910	3.000	3.090	15	60	0.190	0.320
RP152x026x	3.069	3.100	3.131	3.007	3.100	3.193	15	60	0.190	0.320
RP152x027x	2.772	2.800	2.828	2.716	2.800	2.884	15	60	0.200	0.350
RP152x028x	0.980	1.000	1.020	0.940	1.000	1.060	10	40	0.440	0.720
RP152x029x	1.480	1.500	1.520	1.440	1.500	1.560	15	50	0.310	0.550
RP152x030x	3.267	3.300	3.333	3.201	3.300	3.399	15	60	0.190	0.320
RP152x031x	2.673	2.700	2.727	2.619	2.700	2.781	15	60	0.200	0.350
RP152x032x	2.970	3.000	3.030	2.910	3.000	3.090	15	60	0.190	0.320
RP152x033x	3.069	3.100	3.131	3.007	3.100	3.193	15	60	0.190	0.320
RP152x034x	2.574	2.600	2.626	2.522	2.600	2.678	15	60	0.200	0.350
RP152x035x	1.180	1.200	1.220	1.140	1.200	1.260	15	50	0.390	0.620
RP152x036x	2.871	2.900	2.929	2.813	2.900	2.987	15	60	0.200	0.350
RP152x037x	1.980	2.000	2.020	1.940	2.000	2.060	15	60	0.270	0.460
RP152x038x	2.822	2.850	2.879	2.765	2.850	2.936	15	60	0.200	0.350
RP152x039x	3.267	3.300	3.333	3.201	3.300	3.399	15	60	0.190	0.320
RP152x040x	2.822	2.850	2.879	2.765	2.850	2.936	15	60	0.200	0.350

RP152x

NO.EA-200-160707

Product-specific Electrical Characteristics VOUT2 (continued)

Product Name	V _{OUT2} (T _a = 25°C)			V _{OUT2} (-40°C ≤ T _a ≤ 85°C)			ΔV _{OUT2} / ΔI _{OUT}		V _{DIF2}	
	Min.	Typ.	Max.	Min.	Typ.	Max.	Typ.	Max.	Typ.	Max.
RP152x041x	2.970	3.000	3.030	2.910	3.000	3.090	15	60	0.190	0.320
RP152x042x	2.574	2.600	2.626	2.522	2.600	2.678	15	60	0.200	0.350
RP152x043x	2.772	2.800	2.828	2.716	2.800	2.884	15	60	0.200	0.350
RP152x044x	1.480	1.500	1.520	1.440	1.500	1.560	15	50	0.310	0.550
RP152x045x	3.267	3.300	3.333	3.201	3.300	3.399	15	60	0.190	0.320
RP152x046x	2.970	3.000	3.030	2.910	3.000	3.090	15	60	0.190	0.320
RP152x047x	2.772	2.800	2.828	2.716	2.800	2.884	15	60	0.200	0.350
RP152x048x	3.168	3.200	3.232	3.104	3.200	3.296	15	60	0.190	0.320
RP152x049x	2.822	2.850	2.879	2.765	2.850	2.936	15	60	0.200	0.350
RP152x050x	2.871	2.900	2.929	2.813	2.900	2.987	15	60	0.200	0.350
RP152x051x	1.780	1.800	1.820	1.740	1.800	1.860	15	55	0.270	0.460
RP152x052x	2.822	2.850	2.879	2.765	2.850	2.936	15	60	0.200	0.350
RP152x053x	2.673	2.700	2.727	2.619	2.700	2.781	15	60	0.200	0.350
RP152x054x	1.780	1.800	1.820	1.740	1.800	1.860	15	55	0.270	0.460
RP152x055x	2.822	2.850	2.879	2.765	2.850	2.936	15	60	0.200	0.350
RP152x056x	2.970	3.000	3.030	2.910	3.000	3.090	15	60	0.190	0.320
RP152x057x	1.780	1.800	1.820	1.740	1.800	1.860	15	55	0.270	0.460
RP152x058x	0.880	0.900	0.920	0.840	0.900	0.960	10	40	0.500	0.800
RP152x059x	2.871	2.900	2.929	2.813	2.900	2.987	15	60	0.200	0.350
RP152x060x	1.180	1.200	1.212	1.140	1.200	1.260	15	50	0.390	0.620
RP152x061x	2.871	2.900	2.929	2.813	2.900	2.987	15	60	0.200	0.350
RP152x062x	3.069	3.100	3.131	3.007	3.100	3.193	15	60	0.190	0.320

THEORY OF OPERATION

Start-up Sequence Circuit

The RP152xxxxC is equipped with a start-up sequence circuit. VR2 stands-up in 100 μ s delay after VR1 stands up simultaneously with CE. Moreover, to disabling is depending upon the setting output voltage and the external capacitors. VR1 reduces the output voltage by the Nch driver of about 50 Ω , and VR2 reduces the output voltage by the Nch driver of about 10 Ω .

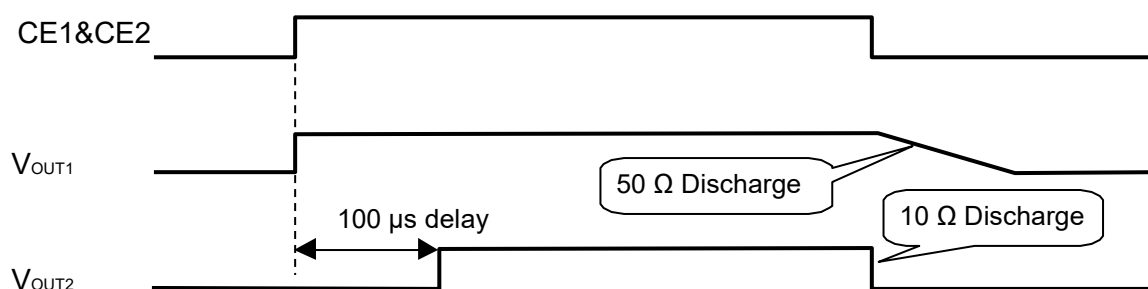

RP152xxxxC Start-up Sequence Circuit

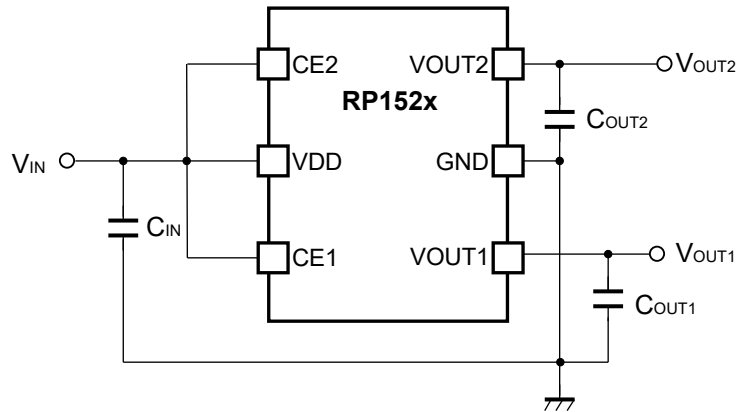
APPLICATION INFORMATION**RP152x Typical Application Circuit****External Components**

Symbol	Description
C_{IN}	Ceramic, 0.22 μ F, Murata: GRM155B31A224KE18B
C_{OUT1}	
C_{OUT2}	

Technical Notes on the Components Selection

- In this device, phase compensation is provided to secure stable operation even when the load current varied. For this purpose, connect 0.22 μ F or more output capacitors (C_{OUT1} , C_{OUT2}) between the VOUT and GND pin with shortest-distance wiring. In case of using a tantalum type capacitor and the ESR (Equivalent Series Resistance) value of the capacitor is large, the output might be unstable. Evaluate the circuit including consideration of frequency characteristics.
- Ensure the VDD and GND lines are sufficiently robust. If their impedance is too high, noise pickup or unstable operation may result. Connect a 0.22 μ F input capacitor (C_{IN}) between the VDD and GND pins with shortest-distance wiring. Refer to *Typical Application Circuit*.

TYPICAL CHARACTERISTICS

Notes: Typical Characteristics are intended to be used as reference data; they are not guaranteed.

1) Output Voltage vs. Output Current (Ta = 25°C)

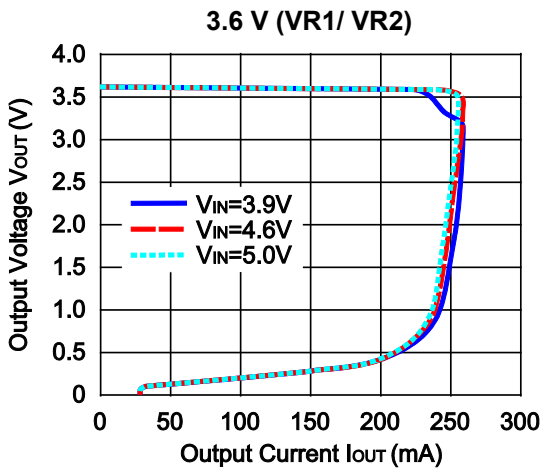
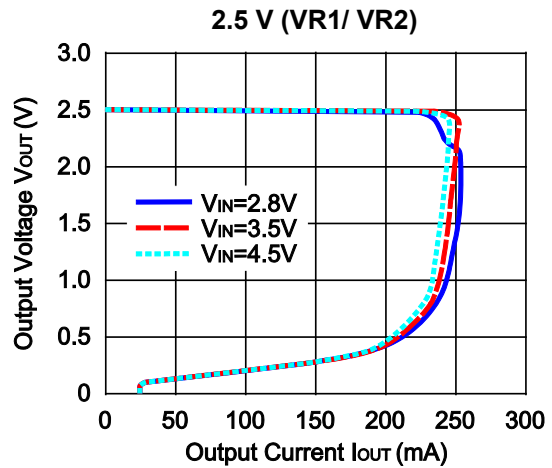
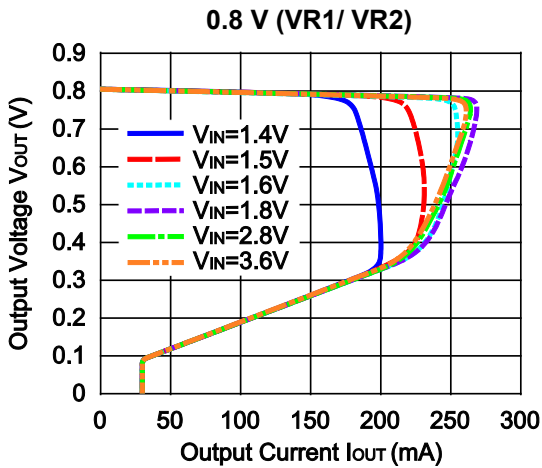

2) Output Voltage vs. Input Voltage (Ta = 25°C)

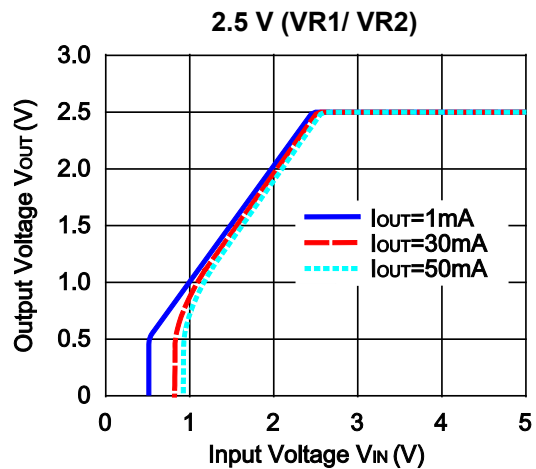
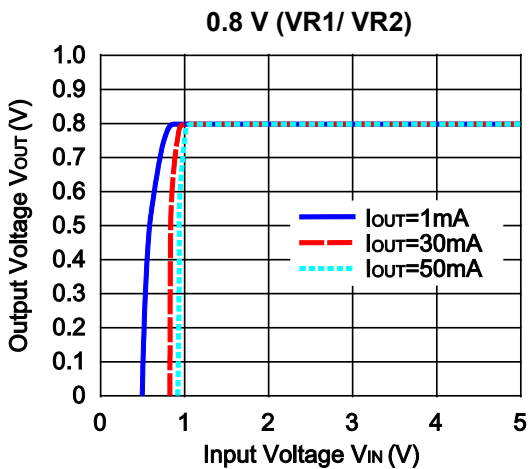



3) Supply Current vs. Input Voltage

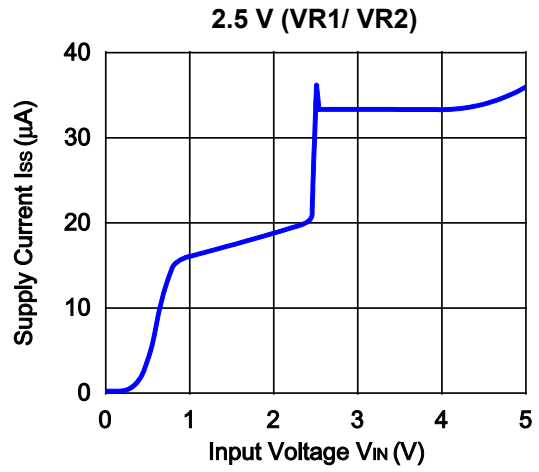
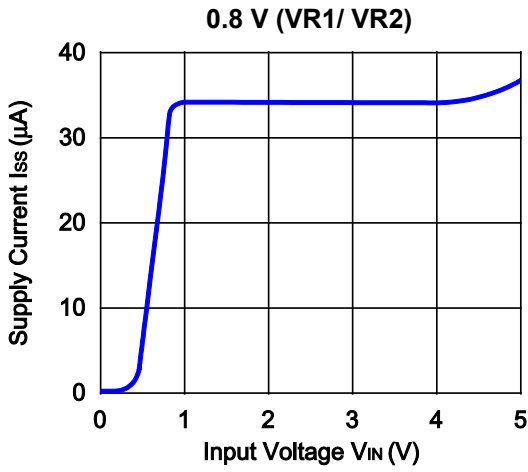

4) Output Voltage vs. Temperature
0.8 V (VR1/ VR2)



2.5 V (VR1/ VR2)



3.6 V (VR1/ VR2)



5) Supply Current vs. Temperature
0.8 V (VR1/ VR2)



2.5 V (VR1/ VR2)



3.6V (VR1/VR2)



6) Dropout Voltage vs. Output Current
0.8 V (VR1/ VR2)

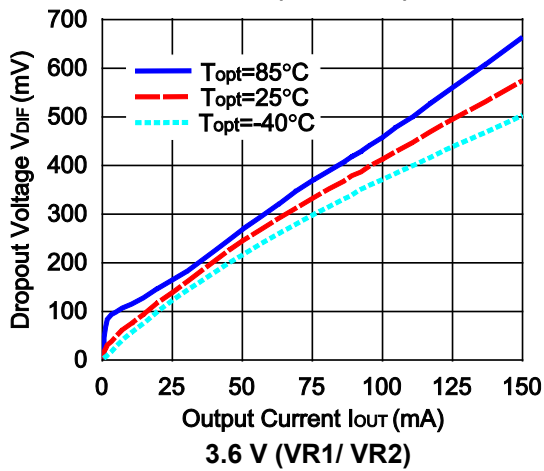

2.5 V (VR1/ VR2)

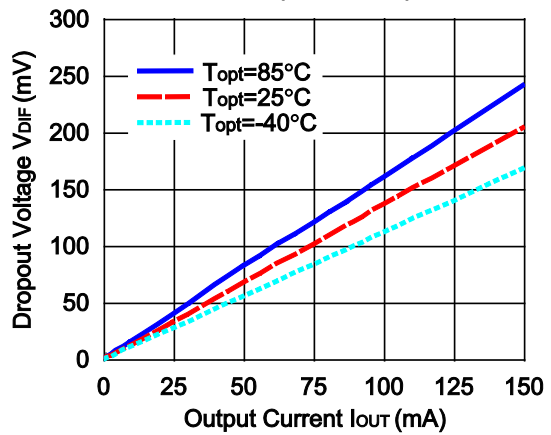

3.6 V (VR1/ VR2)

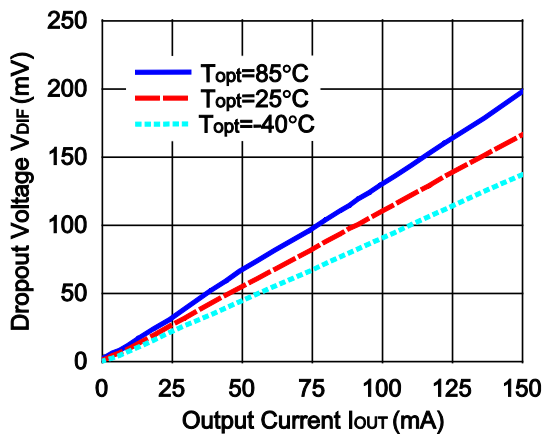

7) Dropout Voltage vs. Set Output Voltage



8) Minimum Operating Voltage
0.8 V (VR1/ VR2)



The hatched area is available for a 0.8-V output device.

9) Ripple Rejection vs. Input Voltage

(C_{IN} = none, C_{OUT1} = C_{OUT2} = Ceramic 0.22 μF , Ripple = 0.2 Vp-p, T_a = 25°C)
2.5 V (VR1/ VR2)

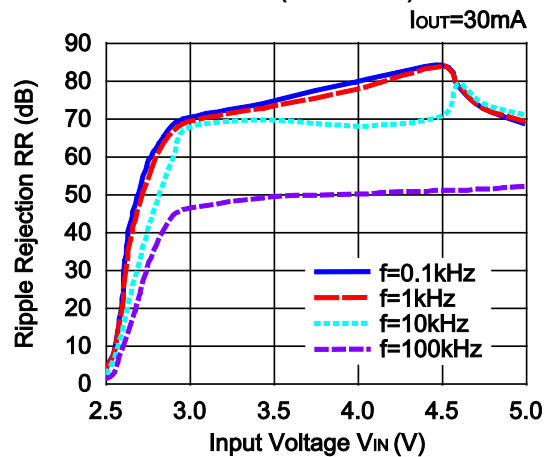
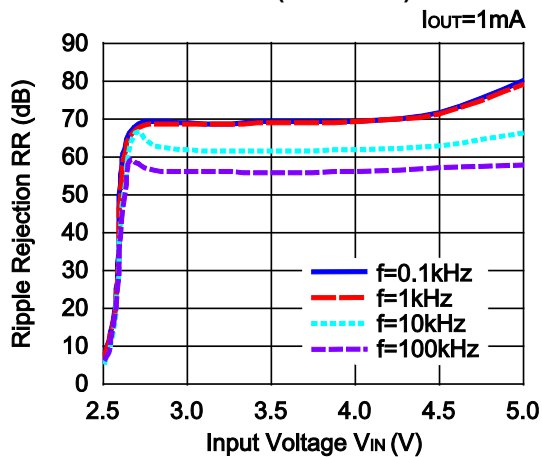

10) Ripple Rejection vs. Frequency

(C_{IN} = none, $C_{OUT1} = C_{OUT2}$ = Ceramic 0.22 μ F, Ripple = 0.2 Vp-p, T_a = 25°C)

0.8 V (VR1/ VR2)

2.5 V (VR1/ VR2)

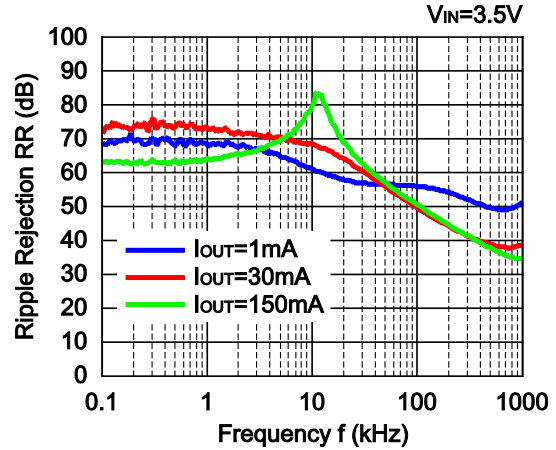
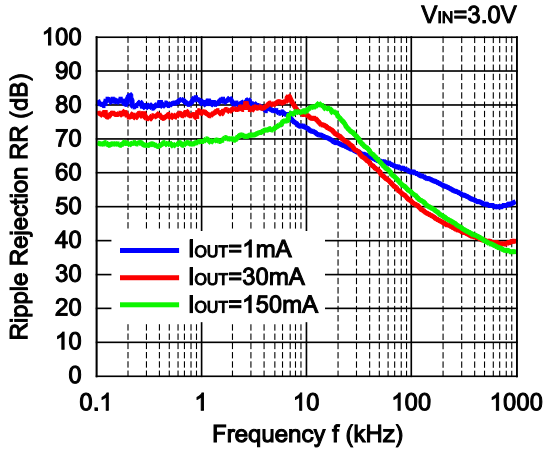

3.6 V (VR1/ VR2)

$V_{IN}=4.6V$

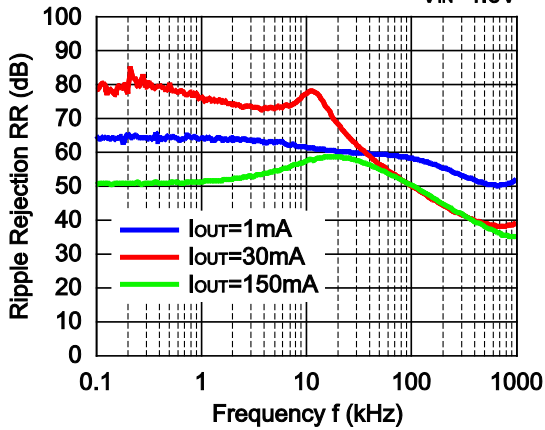

11) Input Transient Response

($I_{OUT} = 30$ mA, $t_r = t_f = 5$ μ s, C_{IN} = none, $C_{OUT1} = C_{OUT2} = 0.22$ μ F, T_a = 25°C)

0.8 V (VR1/ VR2)

2.5 V (VR1/ VR2)

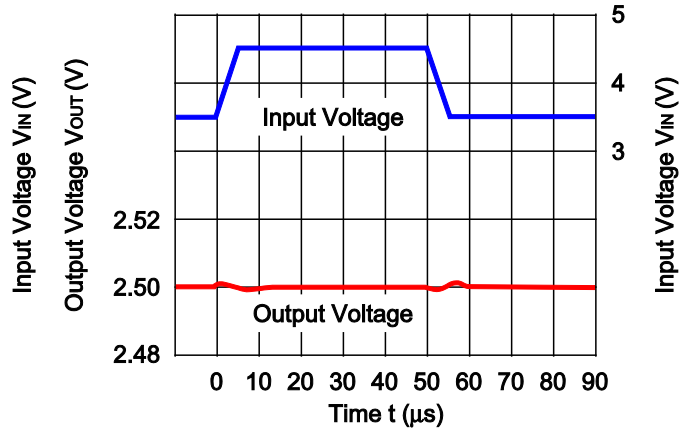
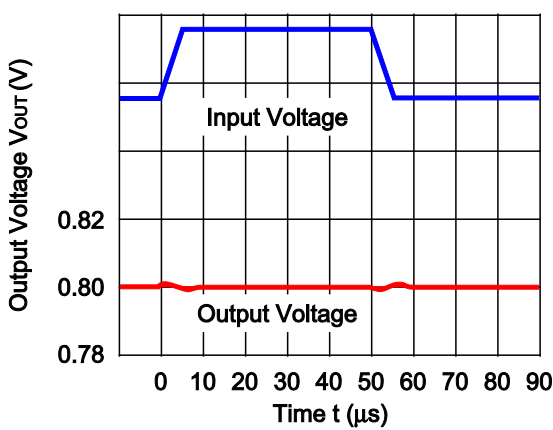

3.6 V (VR1/ VR2)



12) Load Transient Response ($t_r = t_f = 0.5 \mu s$, $C_{IN} = C_{OUT1} = C_{OUT2} = 0.22 \mu F$, $T_a = 25^\circ C$)

0.8 V (VR1/ VR2)



0.8 V (VR1/ VR2)



0.8 V (VR1/ VR2)

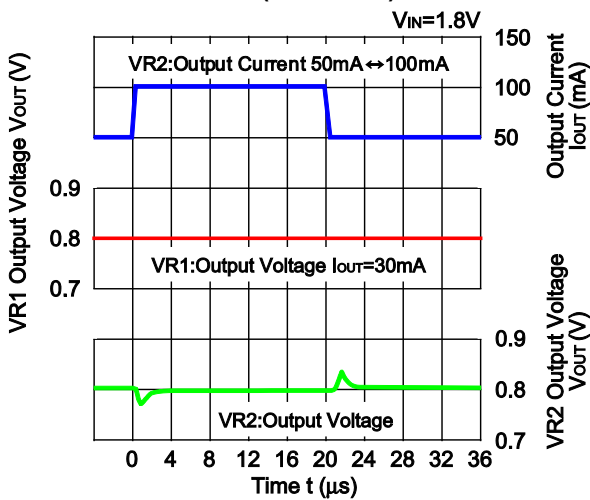

0.8 V (VR1/ VR2)

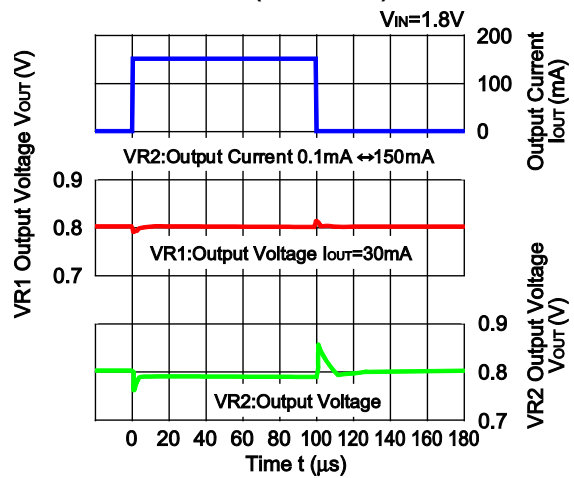

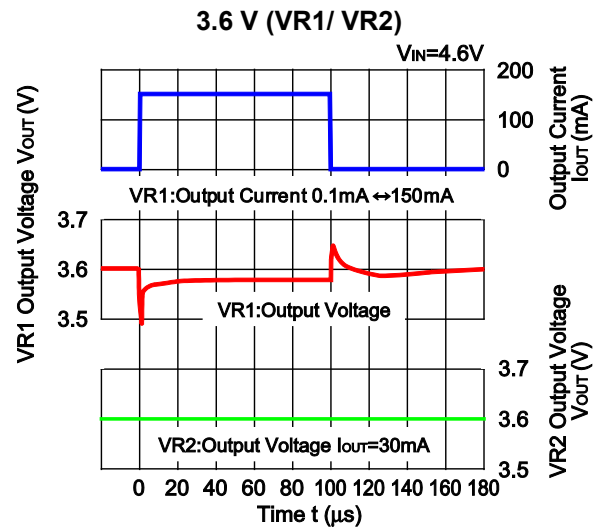
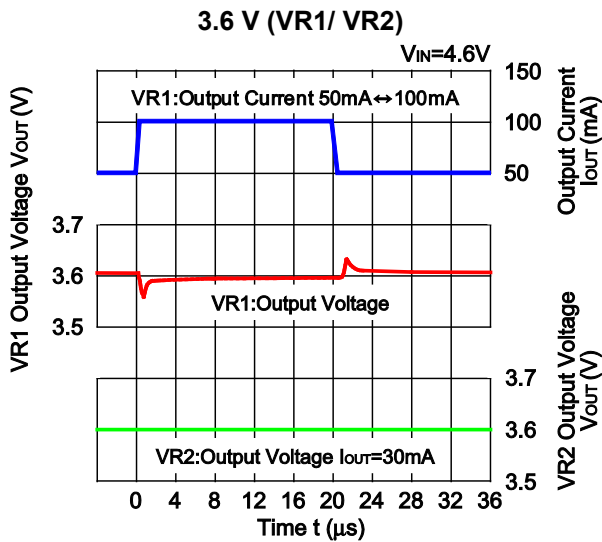
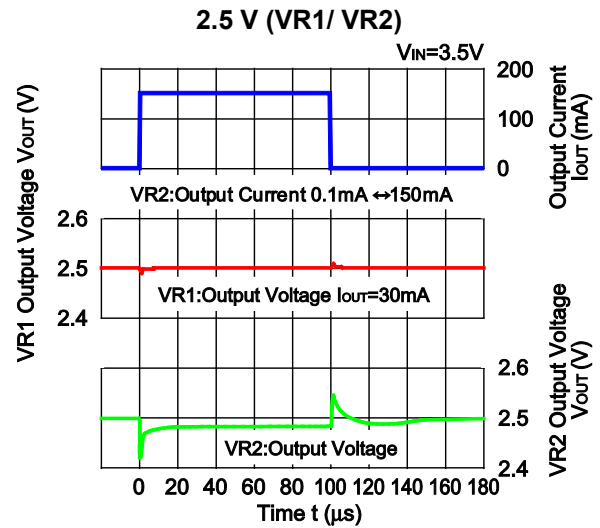
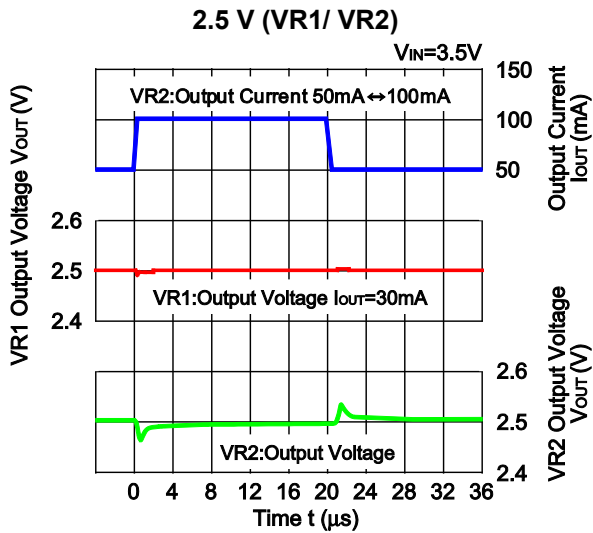
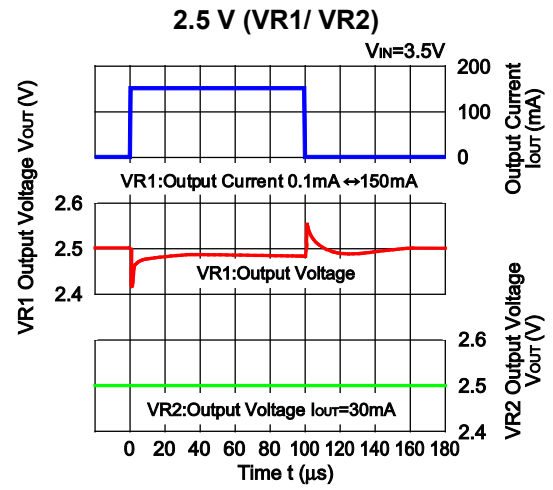
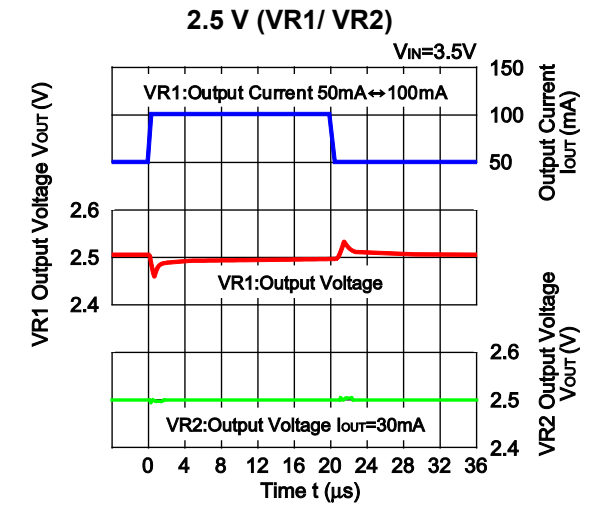

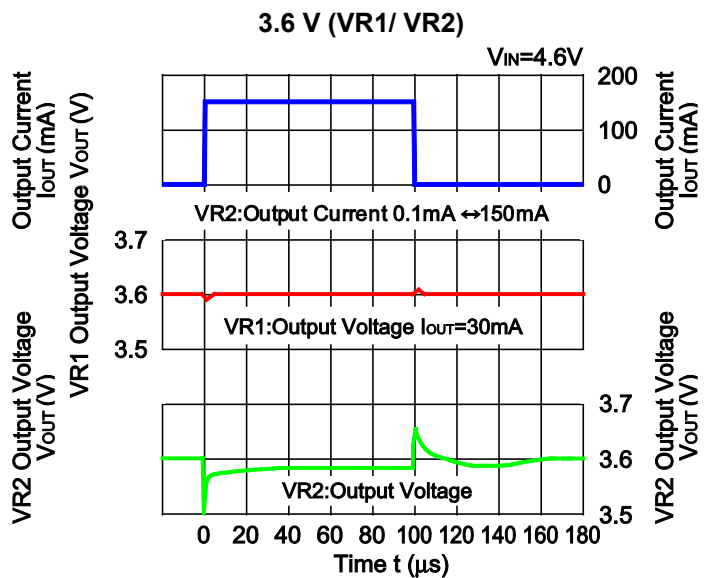
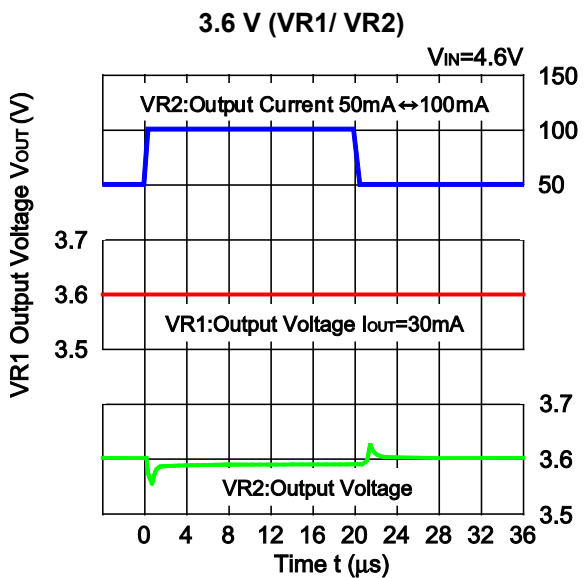

13) Turn On Speed with CE Pin ($C_{IN} = C_{OUT1} = C_{OUT2} = 0.22 \mu F$, $T_a = 25^\circ C$)

0.8 V A/B Version (VR1/ VR2), C Version (VR1)

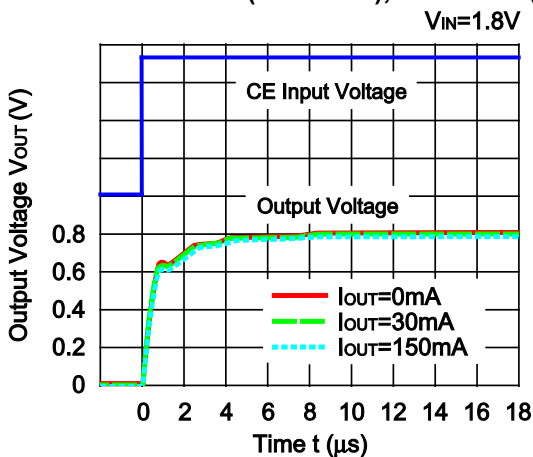

0.8 V C Version (VR2)

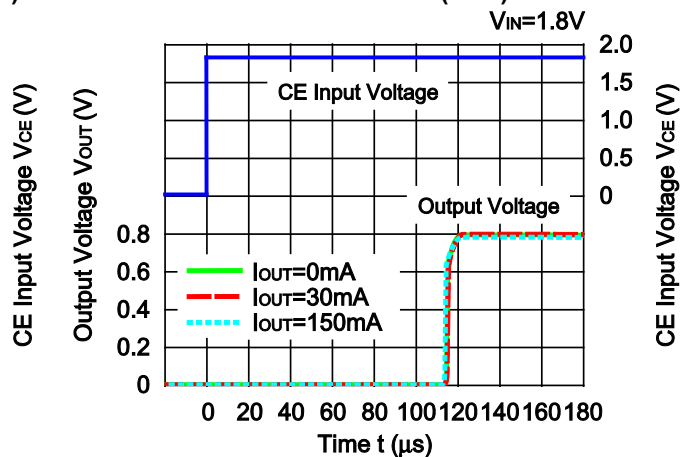

2.5 V A/B Version (VR1/ VR2), C Version (VR1)

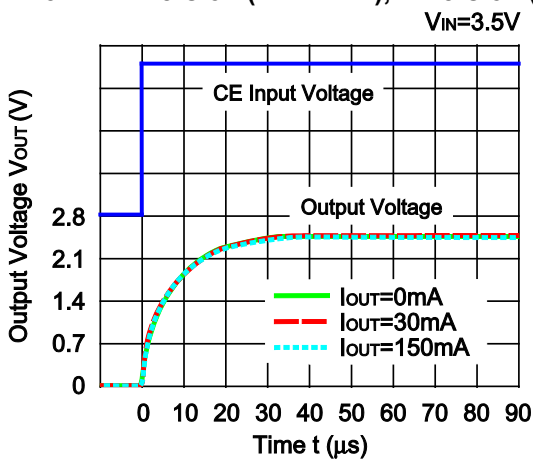

2.5 V C Version (VR2)

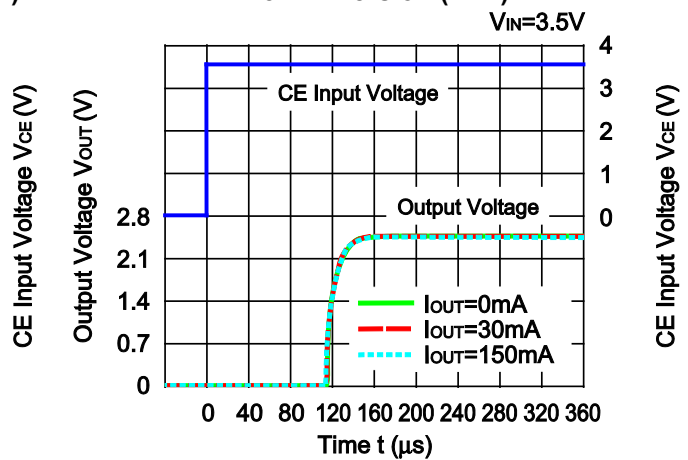

3.6 V A/B Version (VR1/ VR2), C Version (VR1)

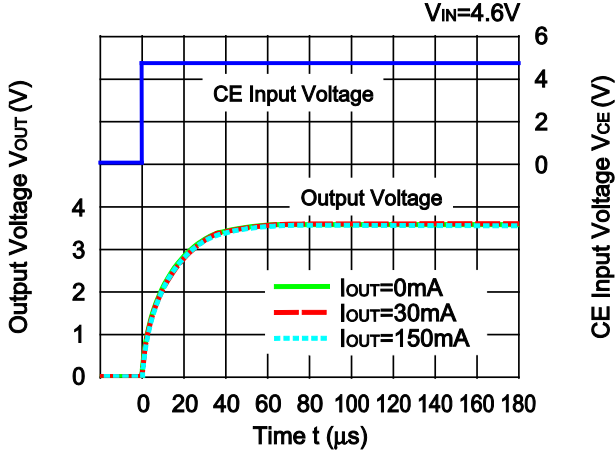

3.6 V C Version (VR2)

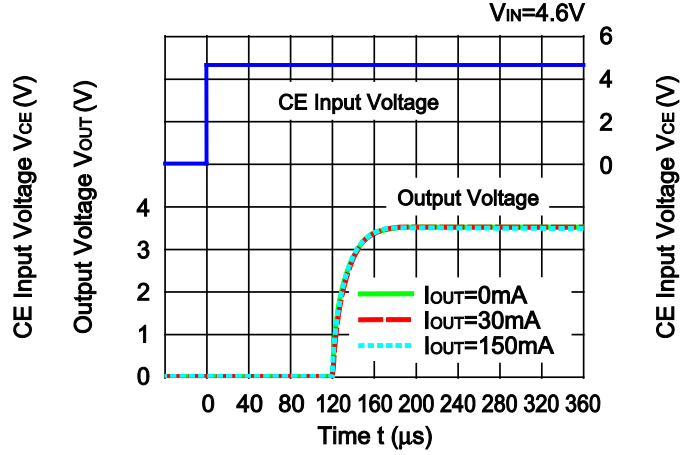

14) Turn Off Speed with CE Pin ($C_{IN} = C_{OUT1} = C_{OUT2} = 0.22 \mu F$, $T_a = 25^\circ C$)

0.8 V B Version (VR1/ VR2), C Version (VR1)

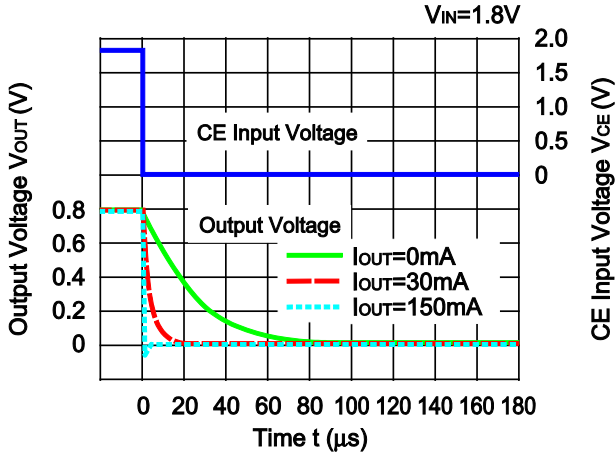

0.8 V C Version (VR2)

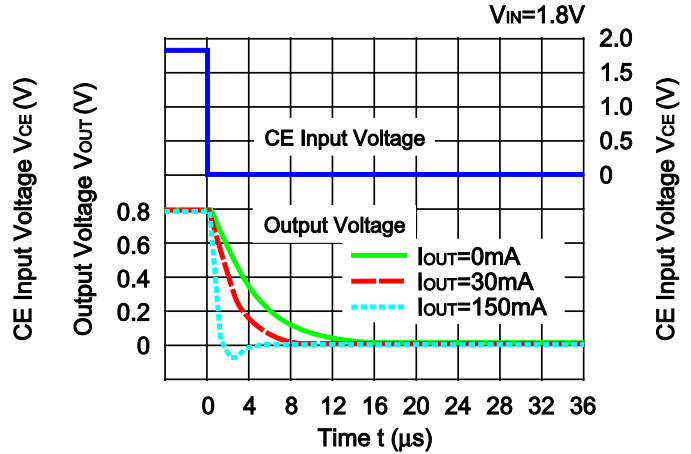

2.5 V B Version (VR1/ VR2), C Version (VR1)

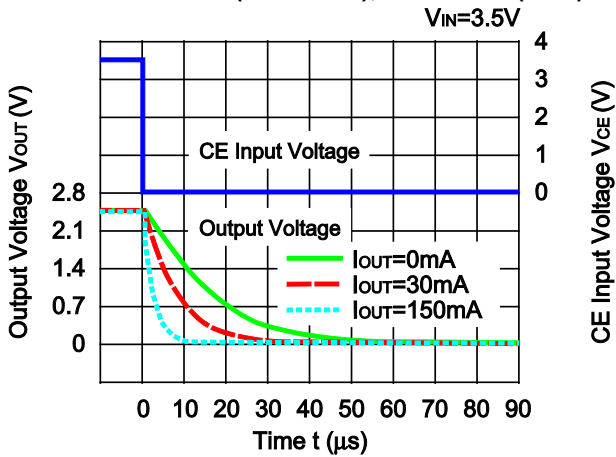

2.5 V C Version (VR2)

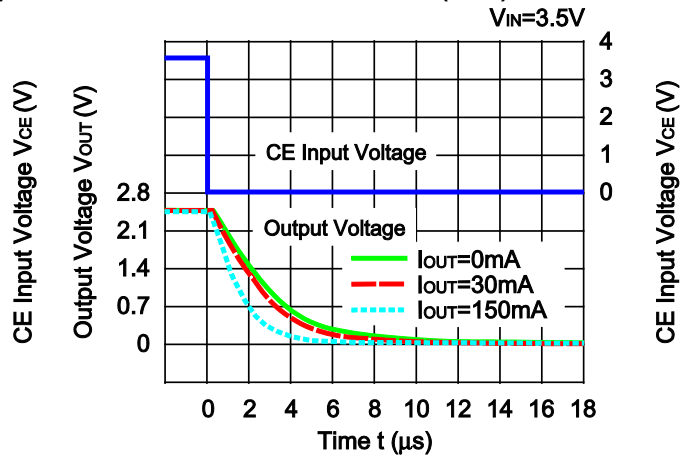

3.6 V B Version (VR1/ VR2), C Version (VR1)

$V_{IN}=4.6V$



3.6 V C Version (VR2)

$V_{IN}=4.6V$

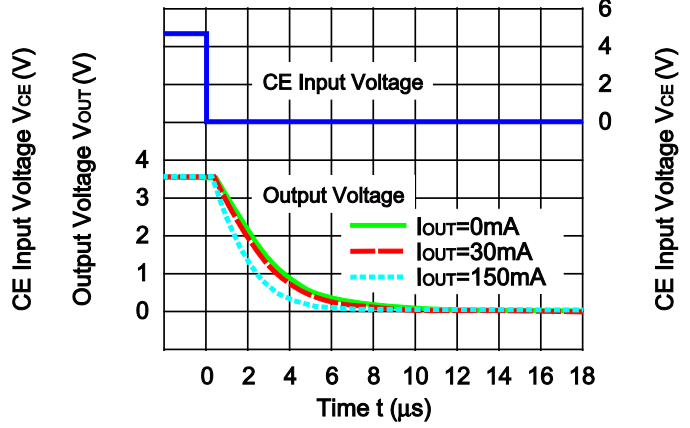

RP152x

NO.EA-200-160707

Equivalent Series Resistance (ESR) vs. Output Current

It is recommended that a ceramic type capacitor be used for the RP152x. However, other types of capacitors having lower ESR can also be used. The relation between the output current (I_{OUT}) and the ESR of output capacitor is shown below.

Measurement Conditions:

- Noise Frequency Band: 10 Hz to 2 MHz
- Measurement Temperature: -40°C to $+85^{\circ}\text{C}$
- Hatched Area: Noise level is $40\ \mu\text{V}$ (avg.) or below.
- C_{IN} , C_{OUT1} , C_{OUT2} : $0.22\ \mu\text{F}$ (Murata: GRM155B10J224KE01)

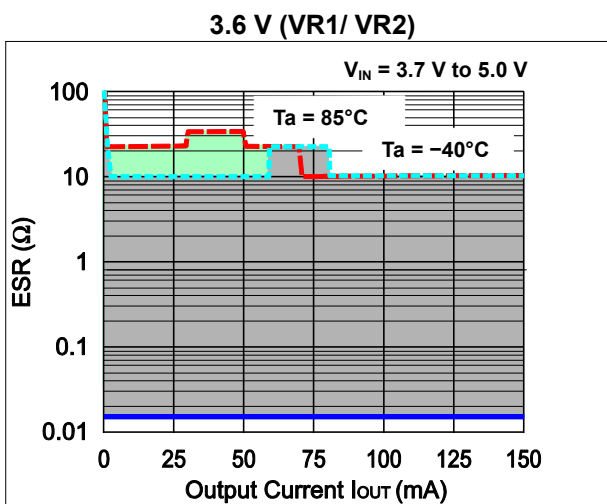
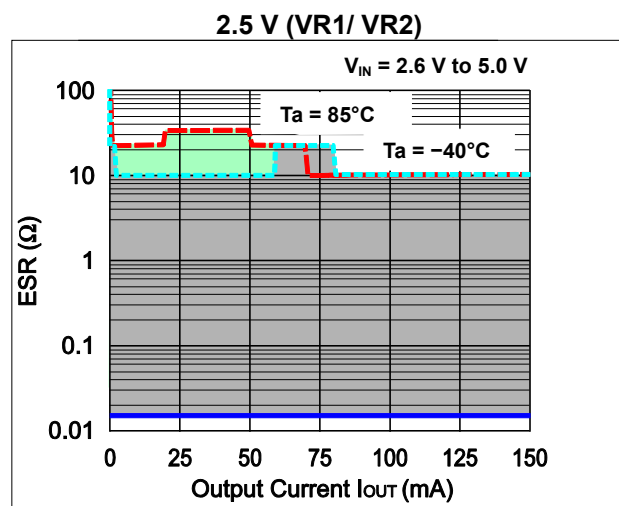
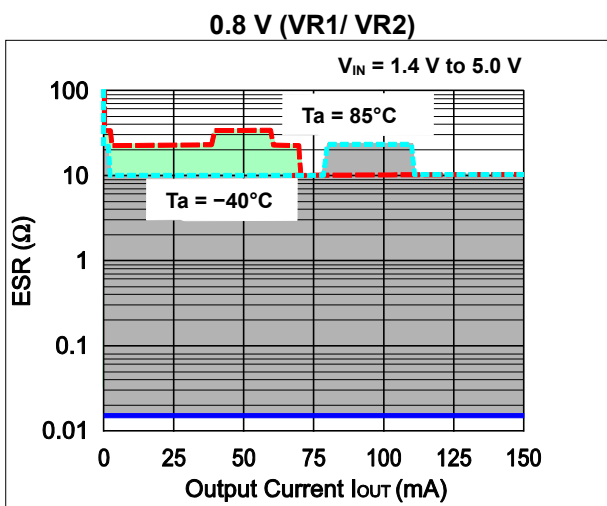

Power Dissipation (P_D) of the package is dependent on PCB material, layout, and environmental conditions. The following conditions are used in this measurement.

Measurement Conditions

	Standard Land Pattern
Environment	Mounting on Board (Wind Velocity = 0 m/s)
Board Material	Glass Cloth Epoxy Plastic (Double-sided)
Board Dimensions	40 mm x 40 mm x 1.6 mm
Copper Ratio	Top-side: Approx. 50%, Back-side: Approx. 50%
Through-holes	ϕ : 0.5 mm x 28 pcs

Measurement Result

($T_a = 25^\circ\text{C}$, $T_{j\text{max}} = 125^\circ\text{C}$)

	Standard Land Pattern
Power Dissipation	600 mW
Thermal Resistance	$\theta_{ja} = (125 - 25^\circ\text{C}) / 0.6 \text{ W} = 167^\circ\text{C/W}$
	$\theta_{jc} = 30^\circ\text{C/W}$



Power Dissipation vs. Ambient Temperature



Measurement Board Pattern

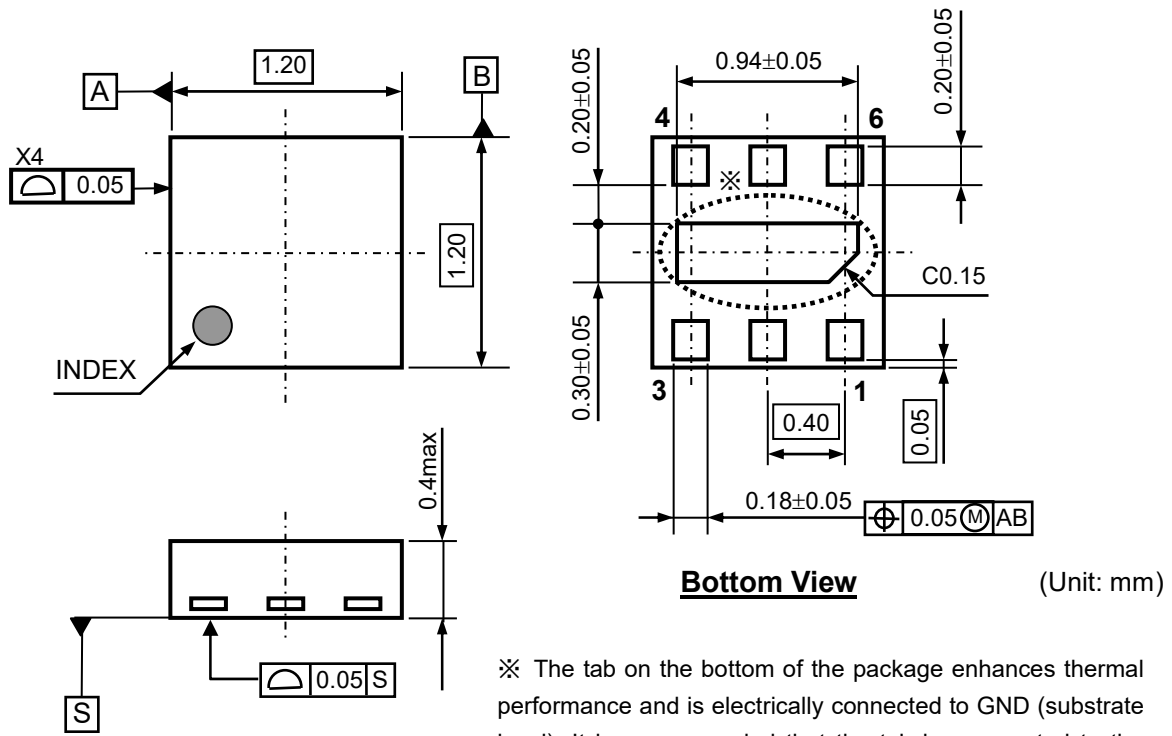

Bottom View

(Unit: mm)

※ The tab on the bottom of the package enhances thermal performance and is electrically connected to GND (substrate level). It is recommended that the tab be connected to the ground plane on the board, or otherwise be left floating.

DFN1212-6 Package Dimensions

Power Dissipation (P_D) of the package is dependent on PCB material, layout, and environmental conditions. The following conditions are used in this measurement.

Measurement Conditions

	Standard Land Pattern
Environment	Mounting on Board (Wind Velocity = 0 m/s)
Board Material	Glass Cloth Epoxy Plastic (Double-sided)
Board Dimensions	40 mm x 40 mm x 1.6 mm
Copper Ratio	Top-side: Approx. 50%, Back-side: Approx. 50%
Through-holes	ϕ 0.5 mm x 44 pcs

Measurement Result

($T_a = 25^\circ\text{C}$, $T_{j\text{max}} = 125^\circ\text{C}$)

	Standard Land Pattern	Free Air
Power Dissipation	420 mW	250 mW
Thermal Resistance	$\theta_{ja} = (125 - 25^\circ\text{C}) / 0.42 \text{ W} = 238^\circ\text{C/W}$	400 $^\circ\text{C/W}$

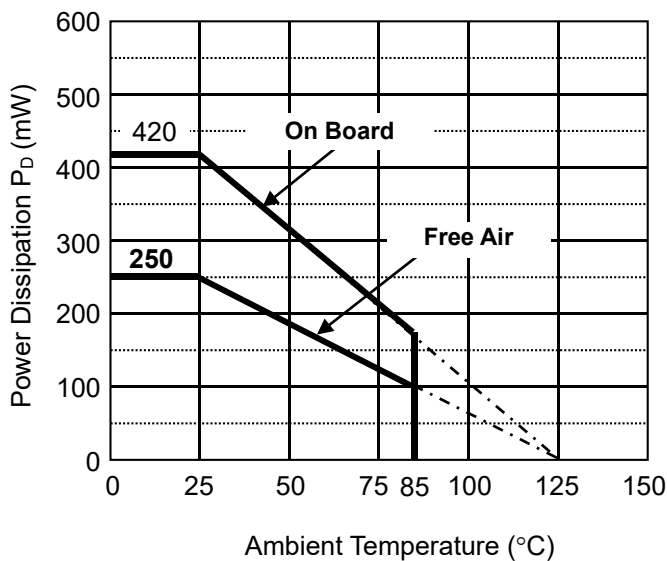

Power Dissipation (mW) vs. Temperature (°C)

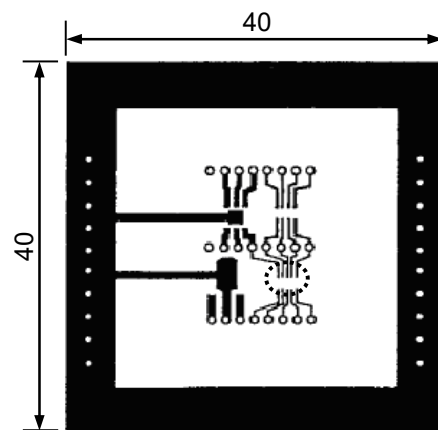

 IC Mount Area (Unit: mm)

Measurement Board Pattern

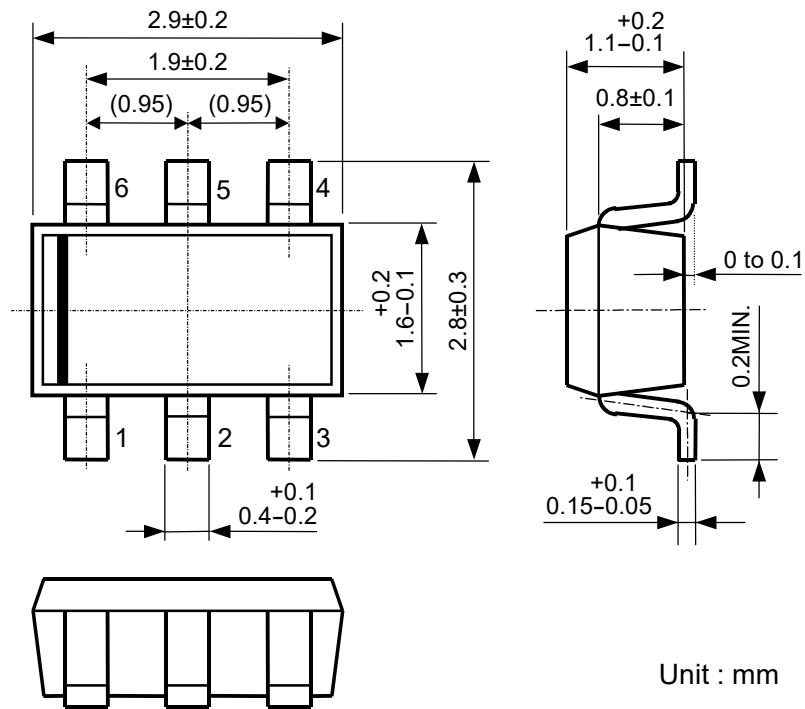

Unit : mm

SOT-23-6 Package Dimensions



1. The products and the product specifications described in this document are subject to change or discontinuation of production without notice for reasons such as improvement. Therefore, before deciding to use the products, please refer to Ricoh sales representatives for the latest information thereon.
2. The materials in this document may not be copied or otherwise reproduced in whole or in part without prior written consent of Ricoh.
3. Please be sure to take any necessary formalities under relevant laws or regulations before exporting or otherwise taking out of your country the products or the technical information described herein.
4. The technical information described in this document shows typical characteristics of and example application circuits for the products. The release of such information is not to be construed as a warranty of or a grant of license under Ricoh's or any third party's intellectual property rights or any other rights.
5. The products listed in this document are intended and designed for use as general electronic components in standard applications (office equipment, telecommunication equipment, measuring instruments, consumer electronic products, amusement equipment etc.). Those customers intending to use a product in an application requiring extreme quality and reliability, for example, in a highly specific application where the failure or misoperation of the product could result in human injury or death (aircraft, spacevehicle, nuclear reactor control system, traffic control system, automotive and transportation equipment, combustion equipment, safety devices, life support system etc.) should first contact us.
6. We are making our continuous effort to improve the quality and reliability of our products, but semiconductor products are likely to fail with certain probability. In order to prevent any injury to persons or damages to property resulting from such failure, customers should be careful enough to incorporate safety measures in their design, such as redundancy feature, fire containment feature and fail-safe feature. We do not assume any liability or responsibility for any loss or damage arising from misuse or inappropriate use of the products.
7. Anti-radiation design is not implemented in the products described in this document.
8. The X-ray exposure can influence functions and characteristics of the products. Confirm the product functions and characteristics in the evaluation stage.
9. WLCSP products should be used in light shielded environments. The light exposure can influence functions and characteristics of the products under operation or storage.
10. There can be variation in the marking when different AOI (Automated Optical Inspection) equipment is used. In the case of recognizing the marking characteristic with AOI, please contact Ricoh sales or our distributor before attempting to use AOI.
11. Please contact Ricoh sales representatives should you have any questions or comments concerning the products or the technical information.



Ricoh is committed to reducing the environmental loading materials in electrical devices with a view to contributing to the protection of human health and the environment.

Ricoh has been providing RoHS compliant products since April 1, 2006 and Halogen-free products since April 1, 2012.

RICOH RICOH ELECTRONIC DEVICES CO., LTD.

<https://www.e-devices.ricoh.co.jp/en/>

Sales & Support Offices

Ricoh Electronic Devices Co., Ltd.

Shin-Yokohama Office (International Sales)

2-3, Shin-Yokohama 3-chome, Kohoku-ku, Yokohama-shi, Kanagawa, 222-8530, Japan
Phone: +81-50-3814-7687 Fax: +81-45-474-0074

Ricoh Americas Holdings, Inc.

675 Campbell Technology Parkway, Suite 200 Campbell, CA 95008, U.S.A.
Phone: +1-408-610-3105

Ricoh Europe (Netherlands) B.V.

Semiconductor Support Centre

Prof. W.H. Keesomlaan 1, 1183 DJ Amstelveen, The Netherlands
Phone: +31-20-5474-309

Ricoh International B.V. - German Branch

Semiconductor Sales and Support Centre

Oberrather Strasse 6, 40472 Düsseldorf, Germany
Phone: +49-211-6546-0

Ricoh Electronic Devices Korea Co., Ltd.

3F, Haesung Bldg, 504, Teheran-ro, Gangnam-gu, Seoul, 135-725, Korea
Phone: +82-2-2135-5700 Fax: +82-2-2051-5713

Ricoh Electronic Devices Shanghai Co., Ltd.

Room 403, No.2 Building, No.690 Bibo Road, Pu Dong New District, Shanghai 201203,
People's Republic of China
Phone: +86-21-5027-3200 Fax: +86-21-5027-3299

Ricoh Electronic Devices Shanghai Co., Ltd.

Shenzhen Branch

1205, Block D (Jinlong Building), Kingkey 100, Hongbao Road, Luohu District,
Shenzhen, China
Phone: +86-755-8348-7600 Ext 225

Ricoh Electronic Devices Co., Ltd.

Taipei office

Room 109, 10F-1, No.51, Hengyang Rd., Taipei City, Taiwan (R.O.C.)
Phone: +886-2-2313-1621/1622 Fax: +886-2-2313-1623

Mouser Electronics

Authorized Distributor

Click to View Pricing, Inventory, Delivery & Lifecycle Information:

Ricoh Electronics:

[RP152L001B-TR](#) [RP152L002B-TR](#) [RP152L003B-TR](#) [RP152L004B-TR](#) [RP152L004C-TR](#) [RP152L006B-TR](#)
[RP152N043B-TR-FE](#) [RP152N045B-TR-FE](#) [RP152N046B-TR-FE](#) [RP152N047B-TR-FE](#) [RP152N030B-TR-FE](#)
[RP152N032B-TR-FE](#) [RP152N035B-TR-FE](#) [RP152N037B-TR-FE](#) [RP152N041B-TR-FE](#) [RP152N042B-TR-FE](#)
[RP152N016B-TR-FE](#) [RP152N020B-TR-FE](#) [RP152N021B-TR-FE](#) [RP152N022B-TR-FE](#) [RP152N024B-TR-FE](#)
[RP152N024C-TR-FE](#) [RP152N004B-TR-FE](#) [RP152N005A-TR-FE](#) [RP152N005C-TR-FE](#) [RP152N006B-TR-FE](#)
[RP152N009B-TR-FE](#) [RP152N013B-TR-FE](#) [RP152L058B-TR](#) [RP152L061B-TR](#) [RP152N001B-TR-FE](#) [RP152N002B-TR-FE](#)
[RP152N002C-TR-FE](#) [RP152N003B-TR-FE](#) [RP152L050B-TR](#) [RP152L051B-TR](#) [RP152L052B-TR](#)
[RP152L053B-TR](#) [RP152L054B-TR](#) [RP152L055B-TR](#) [RP152L042B-TR](#) [RP152L045B-TR](#) [RP152L047B-TR](#)
[RP152L048B-TR](#) [RP152L049A-TR](#) [RP152L049B-TR](#) [RP152L035B-TR](#) [RP152L036B-TR](#) [RP152L038A-TR](#)
[RP152L039B-TR](#) [RP152L040B-TR](#) [RP152L041C-TR](#) [RP152L027B-TR](#) [RP152L030B-TR](#) [RP152L031B-TR](#)
[RP152L032B-TR](#) [RP152L033B-TR](#) [RP152L034B-TR](#) [RP152L022B-TR](#) [RP152L023A-TR](#) [RP152L023B-TR](#)
[RP152L023C-TR](#) [RP152L024B-TR](#) [RP152L026B-TR](#) [RP152L017B-TR](#) [RP152L018B-TR](#) [RP152L019B-TR](#)
[RP152L020C-TR](#) [RP152L021A-TR](#) [RP152L021C-TR](#) [RP152L007A-TR](#) [RP152L008B-TR](#) [RP152L011B-TR](#)
[RP152L012B-TR](#) [RP152L013B-TR](#) [RP152L016B-TR](#) [RP152L001C-TR](#) [RP152L002A-TR](#) [RP152L002C-TR](#)
[RP152L003A-TR](#) [RP152L005C-TR](#) [RP152L006A-TR](#) [RP152L059B-TR](#) [RP152L060B-TR](#) [RP152N005B-TR-FE](#)
[RP152N006A-TR-FE](#) [RP152N010B-TR-FE](#) [RP152N041A-TR-FE](#) [RP152L021B-TR](#) [RP152L025B-TR](#) [RP152L029B-TR](#)
[RP152L044B-TR](#) [RP152L056B-TR](#) [RP152L057A-TR](#) [RP152L007B-TR](#) [RP152L009B-TR](#) [RP152L010A-TR](#)
[RP152L010B-TR](#) [RP152L014B-TR](#) [RP152L020B-TR](#)



Компания «ЭлектроПласт» предлагает заключение долгосрочных отношений при поставках импортных электронных компонентов на взаимовыгодных условиях!

Наши преимущества:

- Оперативные поставки широкого спектра электронных компонентов отечественного и импортного производства напрямую от производителей и с крупнейших мировых складов;
- Поставка более 17-ти миллионов наименований электронных компонентов;
- Поставка сложных, дефицитных, либо снятых с производства позиций;
- Оперативные сроки поставки под заказ (от 5 рабочих дней);
- Экспресс доставка в любую точку России;
- Техническая поддержка проекта, помощь в подборе аналогов, поставка прототипов;
- Система менеджмента качества сертифицирована по Международному стандарту ISO 9001;
- Лицензия ФСБ на осуществление работ с использованием сведений, составляющих государственную тайну;
- Поставка специализированных компонентов (Xilinx, Altera, Analog Devices, Intersil, Interpoint, Microsemi, Aeroflex, Peregrine, Syfer, Eurofarad, Texas Instrument, Miteq, Cobham, E2V, MA-COM, Hittite, Mini-Circuits, General Dynamics и др.);

Помимо этого, одним из направлений компании «ЭлектроПласт» является направление «Источники питания». Мы предлагаем Вам помощь Конструкторского отдела:

- Подбор оптимального решения, техническое обоснование при выборе компонента;
- Подбор аналогов;
- Консультации по применению компонента;
- Поставка образцов и прототипов;
- Техническая поддержка проекта;
- Защита от снятия компонента с производства.



Как с нами связаться

Телефон: 8 (812) 309 58 32 (многоканальный)

Факс: 8 (812) 320-02-42

Электронная почта: org@eplast1.ru

Адрес: 198099, г. Санкт-Петербург, ул. Калинина, дом 2, корпус 4, литера А.