

Ultra compact and efficient 2-stage filter in ECO design for 3-phase systems



See below:

Approvals and Compliances

Description

- High attenuation value

Applications

- Voltage rating 480 VAC for world wide acceptance
- Especially designed for industrial applications such as: Frequency Converters, Stepper Motor Drives, UPS-Systems, Inverters
- Suitable for use in equipment according to IEC/UL 62368-1

Weblinks

[pdf data sheet](#), [html datasheet](#), [General Product Information](#), [Approvals](#), [Distributor-Stock-Check](#), [Detailed request for product](#), [Microsite](#)

Technical Data

Rated Current	10 - 115A
Rated voltage	480VAC, 50/60 Hz
Approval for	10 - 115A @ Ta 40 °C / 480VAC; 50/60Hz
Overload Current	1.5 x Ir for 1 minute, per hour
Leakage Current	standard < 0.5mA (440V / 50Hz)
Dielectric Strength	480VAC: > 2.25kVDC between L-L > 3kVDC between L-PE
Number of Filter Stages	2-stage
Weight	1.1 - 5kg
Material: Housing	Aluminum
Sealing Compound	UL 94V-0

Mounting	Screw-on mounting on chassis, upright or lengthwise
Terminal	Bolts and nuts
Operating Temperature	-25 °C to 100 °C
Climatic Category	25/100/21 acc. to IEC 60068-1
Degree of Protection	IP20 acc. to IEC 60529
Protection Class	Suitable for appliances with protection class I acc. to IEC 61140
MTBF	> 200'000h acc. to MIL-HB-217 F

Approvals and Compliances

Detailed information on product approvals, code requirements, usage instructions and detailed test conditions can be looked up in [Details about Approvals](#)

SCHURTER products are designed for use in industrial environments. They have approvals from independent testing bodies according to national and international standards. Products with specific characteristics and requirements such as required in the automotive sector according to IATF 16949, medical technology according to ISO 13485 or in the aerospace industry can be offered exclusively with customer-specific, individual agreements by SCHURTER.

Approvals

The approval mark is used by the testing authorities to certify compliance with the safety requirements placed on electronic products.

Approval Reference Type: FMBC ECO

Approval Logo	Certificates	Certification Body	Description
	VDE Approvals	VDE	Certificate Number: 40023521
	UL Approvals	UL	UL File Number: E72928

Product standards

Product standards that are referenced

Organization	Design	Standard	Description
	Designed according to	IEC 60939	Passive filters for suppressing electromagnetic interference
	Designed according to	UL 1283	Electromagnetic interference filters





Application standards

Application standards where the product can be used

Organization	Design	Standard	Description
	Designed for applications acc.	IEC/UL 62368-1	IEC 62368-1 includes the basic requirements for safety of audio, video, information technology and office equipment.

Compliances

The product complies with following Guide Lines

Identification	Details	Initiator	Description
	CE declaration of conformity	SCHURTER AG	The CE marking declares that the product complies with the applicable requirements laid down in the harmonisation of Community legislation on its affixing in accordance with EU Regulation 765/2008.
	RoHS	SCHURTER AG	Directive RoHS 2011/65/EU, Amendment (EU) 2015/863
	China RoHS	SCHURTER AG	The law SJ / T 11363-2006 (China RoHS) has been in force since 1 March 2007. It is similar to the EU directive RoHS.
	REACH	SCHURTER AG	On 1 June 2007, Regulation (EC) No 1907/2006 on the Registration, Evaluation, Authorization and Restriction of Chemicals 1 (abbreviated as "REACH") entered into force.

Dimension [mm]

Case 94

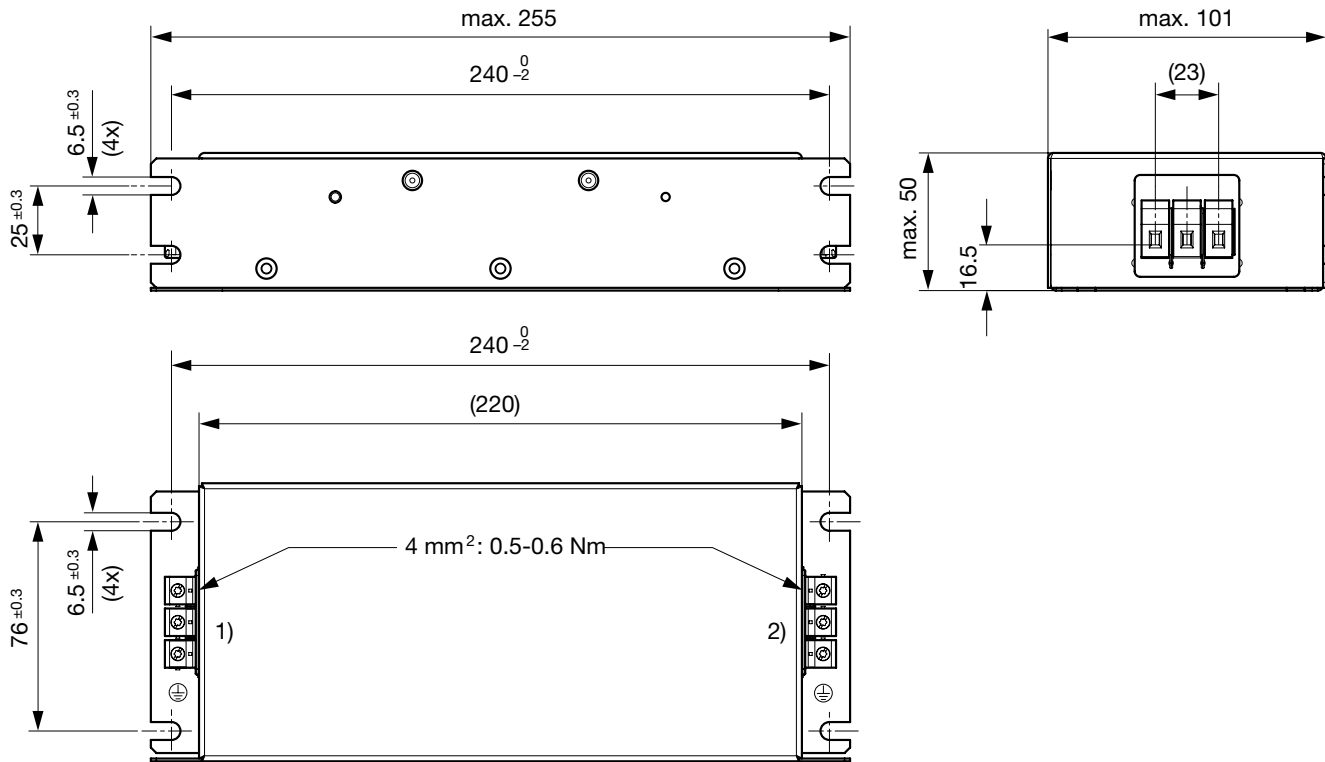

- 1) Line
- 2) Load

Case 95

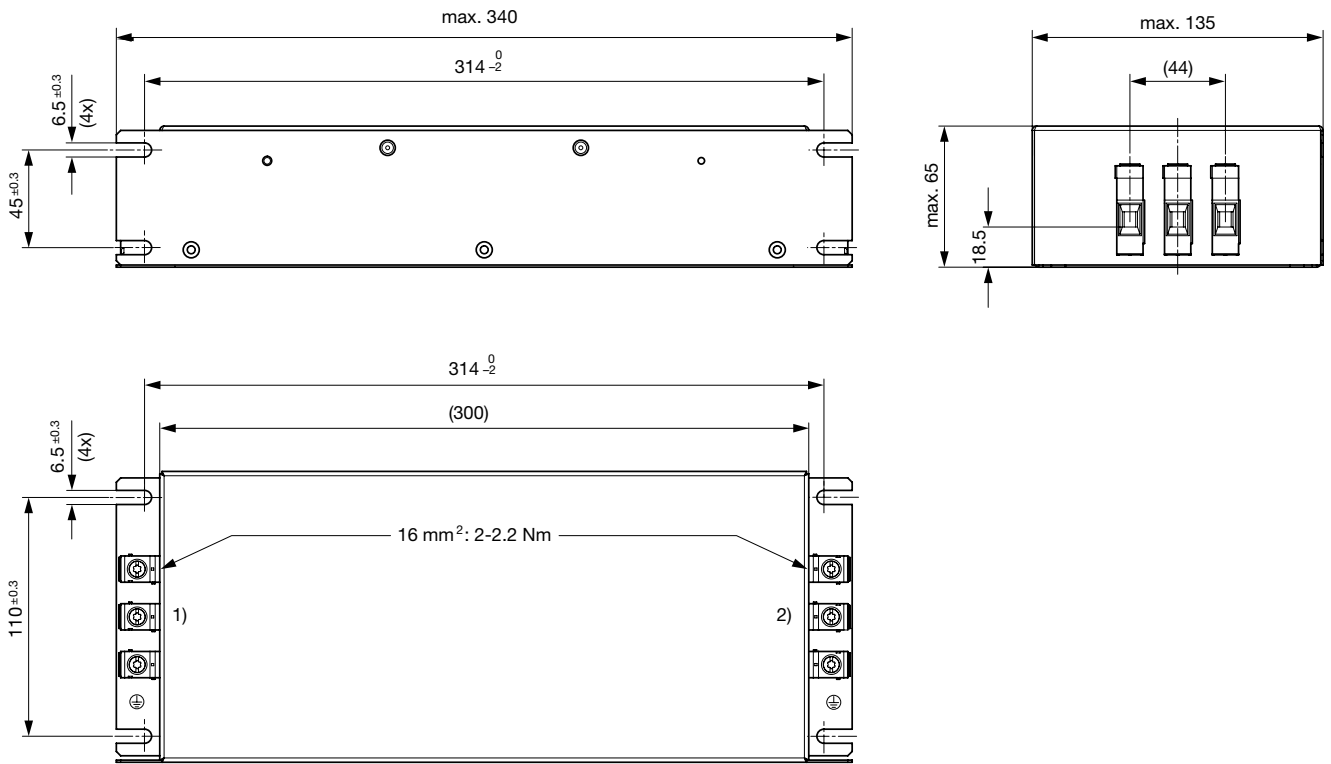

- 1) Line
- 2) Load

Case 96

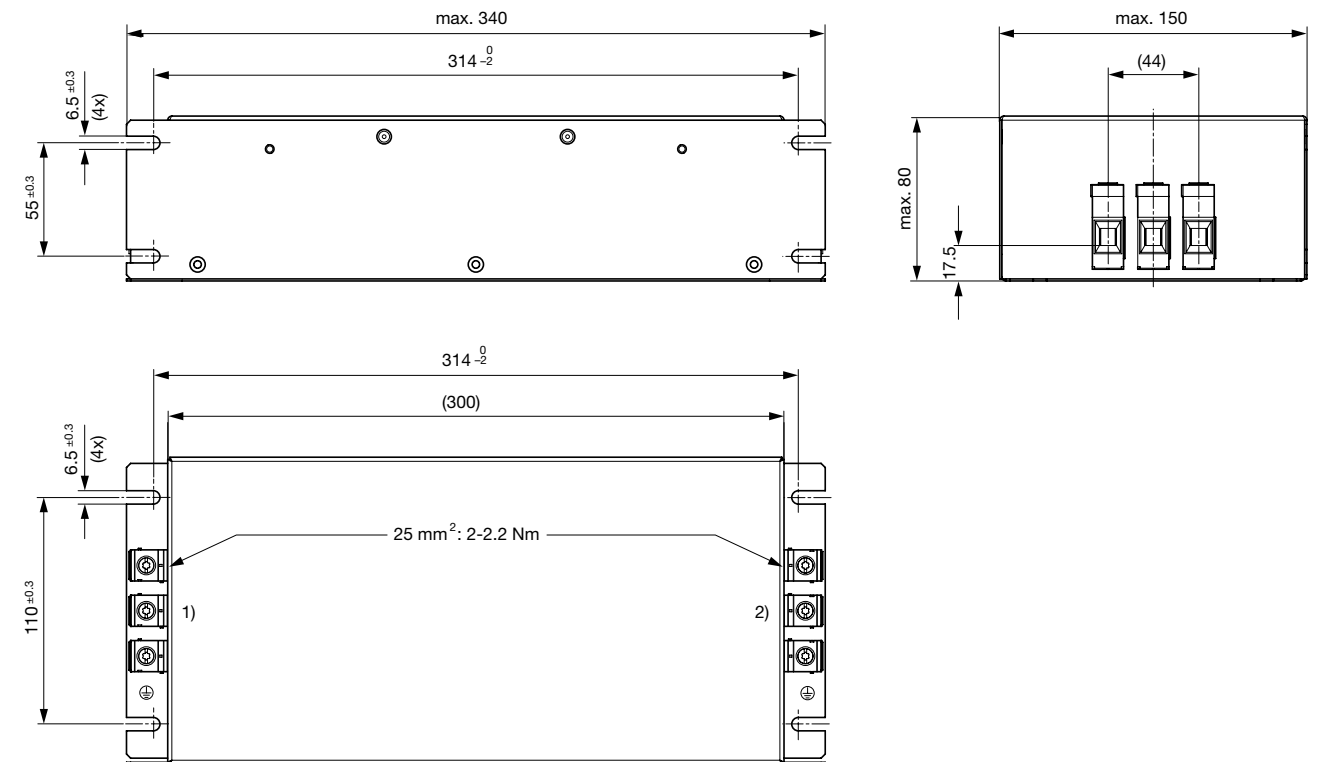

- 1) Line
- 2) Load

Case 97

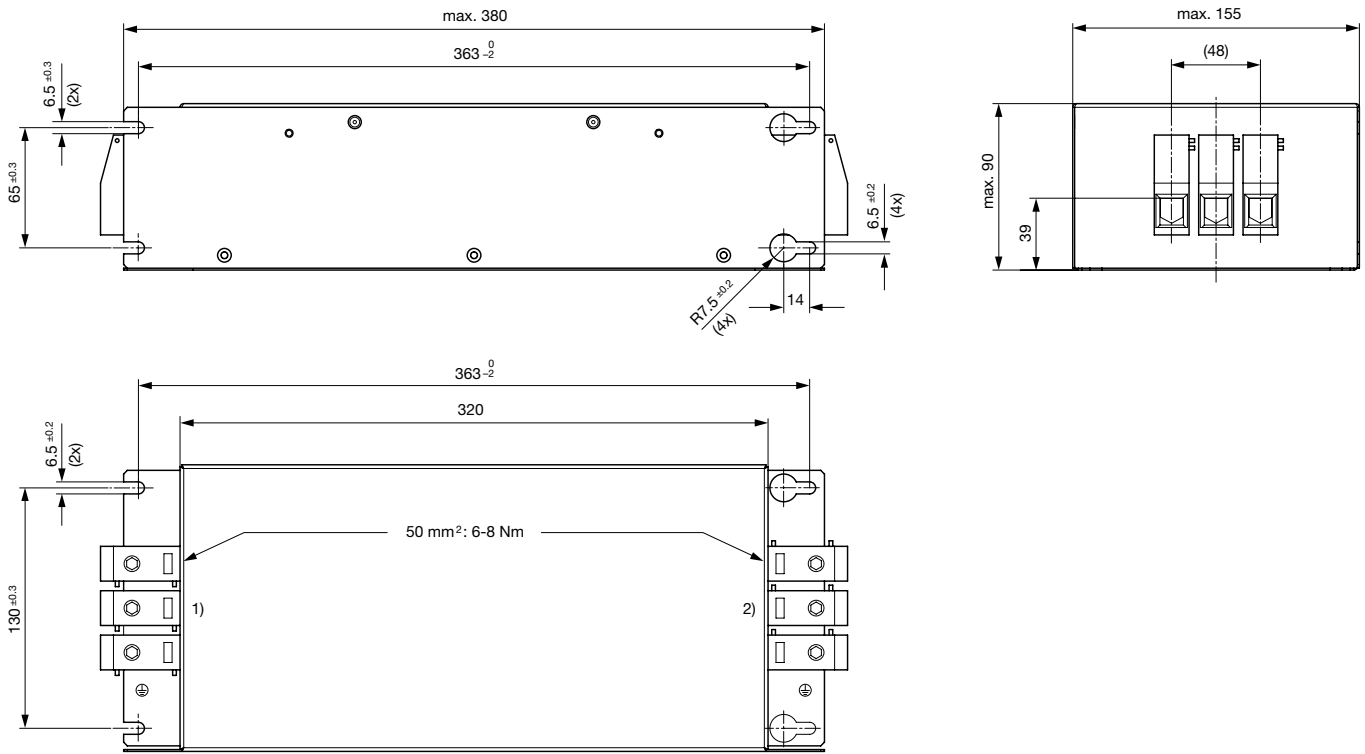

- 1) Line
- 2) Load

Technical data to the filter components

Rated Current [A]	L [mH]	C1 [µF]	C2 [µF]	C3 [µF]	C4 [nF]	R1 [MΩ]	R2 [MΩ]	Netzfilter Aus-
10	2.3	1	1	1	10	1	1	Indus-
20	1.5	1	1	1	10	1	1	Indus-
36	0.9	1	1	2.2	47	1	1	Indus-
50	0.45	1	1	2.2	47	1	1	Indus-
66	0.45	1	1	2.2	47	1	1	Indus-
80	0.32	1	1	2.2	47	1	1	Indus-
115	0.24	1	2.2	2.2	100	1	1	Indus-

Diagrams

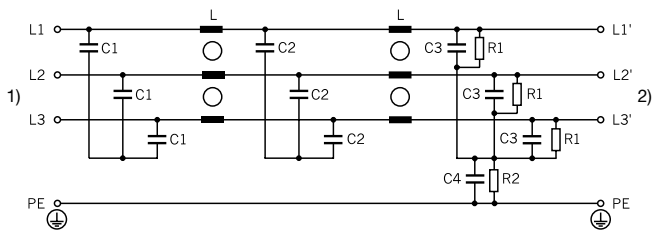

- 1) Line
- 2) Load

Attenuation Loss

--- 50Ω differential mode ____ 50Ω common mode

Industrial version

10A (FMBC-0994-1000)

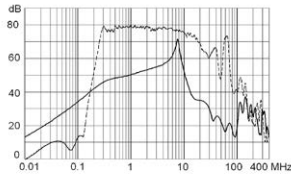

20A (FMBC-0994-2000)

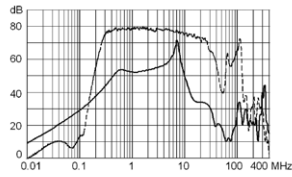

36A (FMBC-0995-3600)

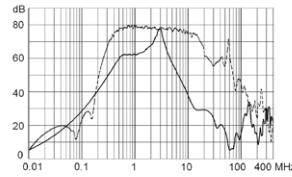

50A (FMBC-0996-5000)

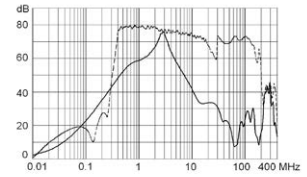

66A (FMBC-0996-6600)

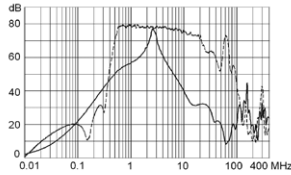

80A (FMBC-0996-8000)

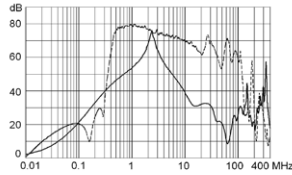

115A (FMBC-0997-H115)

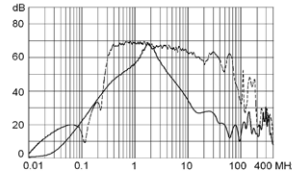

All Variants

Rated Current @ Ta 50°C (75°C) [A]	Tripped Power Dissipation [W]	Contact Resistance [mΩ]	Leakage Current [mA] @ 440V,	Weight [kg]	Screw clamps	Housings	Packaging unit [PCS]	Order Number
10	4	37	0.04	1.1 kg	4	94	1	FMBC-0994-1000
20	9	20	0.04	1.6 kg	4	94	1	FMBC-0994-2000
36	5	3.5	0.2	2.2 kg	16	95	1	FMBC-0995-3600
50	20	7.5	0.2	2.7 kg	16	95	1	FMBC-0995-5000
66	22	4.5	0.2	3.4 kg	25	96	1	FMBC-0996-6600
80	24	3.5	0.2	3.4 kg	25	96	1	FMBC-0996-8000
115	36	2.5	0.4	5 kg	50	97	1	FMBC-0997-H115

Most Popular.

Availability for all products can be searched real-time: <https://www.schurter.com/en/Stock-Check/Stock-Check-SCHURTER>

1) Leakage current according IEC 60939-1

2) Maximum conductor cross section (wire gauge) to be used; a comparative table for AWG and mm² values can be found in the general product information <https://www.schurter.com/en/FAQ#10>

Packaging unit 1 Pcs



Компания «ЭлектроПласт» предлагает заключение долгосрочных отношений при поставках импортных электронных компонентов на взаимовыгодных условиях!

Наши преимущества:

- Оперативные поставки широкого спектра электронных компонентов отечественного и импортного производства напрямую от производителей и с крупнейших мировых складов;
- Поставка более 17-ти миллионов наименований электронных компонентов;
- Поставка сложных, дефицитных, либо снятых с производства позиций;
- Оперативные сроки поставки под заказ (от 5 рабочих дней);
- Экспресс доставка в любую точку России;
- Техническая поддержка проекта, помощь в подборе аналогов, поставка прототипов;
- Система менеджмента качества сертифицирована по Международному стандарту ISO 9001;
- Лицензия ФСБ на осуществление работ с использованием сведений, составляющих государственную тайну;
- Поставка специализированных компонентов (Xilinx, Altera, Analog Devices, Intersil, Interpoint, Microsemi, Aeroflex, Peregrine, Syfer, Eurofarad, Texas Instrument, Miteq, Cobham, E2V, MA-COM, Hittite, Mini-Circuits, General Dynamics и др.);

Помимо этого, одним из направлений компании «ЭлектроПласт» является направление «Источники питания». Мы предлагаем Вам помощь Конструкторского отдела:

- Подбор оптимального решения, техническое обоснование при выборе компонента;
- Подбор аналогов;
- Консультации по применению компонента;
- Поставка образцов и прототипов;
- Техническая поддержка проекта;
- Защита от снятия компонента с производства.



Как с нами связаться

Телефон: 8 (812) 309 58 32 (многоканальный)

Факс: 8 (812) 320-02-42

Электронная почта: org@eplast1.ru

Адрес: 198099, г. Санкт-Петербург, ул. Калинина, дом 2, корпус 4, литера А.