

# Series 51

## Characteristics

The compact 16mm Series 51 is particularly suited for applications in the areas:

- Flush design
- Raised design
- PCB (with adaptor)

The low level switching element is laid out for low current applications.

## Functions

The Series 51 incorporates the following functions:

- Indicator
- Pushbutton
- Illuminated pushbutton
- Stop switch
- Keylock switch
- Selector switch

## Market segments

The EAO Series 51 is especially suited for applications in the segments:

- Machinery and Automation
- Panel building

Please refer to the EAO website to obtain detailed information regarding this series [www.products.eao.com](http://www.products.eao.com)  
Configure a product to your exact needs and request a quotation.





**Overview****Flush design**

|                        |    |
|------------------------|----|
| Indicator              | 4  |
| Pushbutton             | 5  |
| Illuminated pushbutton | 7  |
| Keylock switch         | 15 |
| Selector switch        | 21 |

**Raised design**

|                          |    |
|--------------------------|----|
| Indicator                | 31 |
| Illuminated pushbutton   | 33 |
| Stop switch              | 37 |
| Mushroom-head pushbutton | 39 |
| Keylock switch           | 41 |
| Selector switch          | 47 |

**Accessories**

52

**Drawings**

76

**Technical data**

77

**Marking**

81

**Application guidelines**

83

**Index**

84

# 51 Flush design

## Indicator square, IP 65



Product can differ from the current configuration.



Dimensions [mm]  
 H = Universal terminal 2.0 x 0.5 mm,  
 L = Solder terminal,  
 L1 = Solder terminal 2.8 x 0.5 mm

### Additional Information

- For front dimension 24 x 24 mm



Mounting cut-outs [mm]

### Equipment consisting of (schematic overview)



Each Part Number listed below includes all the black components shown in the 3D-drawing.

*To obtain a complete unit, please select the red components from the pages shown.*

| Terminal  | Part No.           | Component layout | Wiring diagram | Weight   |
|---|--------------------|------------------|----------------|----------|
|  <b>Indicator actuator square, flush design</b> |                    |                  |                |          |
| Solder 2.8 x 0.5 mm   | <b>51-050.002F</b> |                  | 1              | 0.004 kg |
| Solder  | <b>51-050.005F</b> |                  | 1              | 0.004 kg |
| Universal 2.0 x 0.5 mm  | <b>51-051.006F</b> | 4                | 1              | 0.005 kg |

The component layouts you will find from page 76



## Indicator rectangular, IP 65

### Equipment consisting of (schematic overview)



**Lens** page 52



**Single-LED** page 71



**Actuator**



**Front bezel set** page 60



**Fixing nut**

Each Part Number listed below includes all the black components shown in the 3D-drawing.

To obtain a complete unit, please select the red components from the pages shown.



Dimensions [mm]  
 H = Universal terminal 2.0 x 0.5 mm,  
 L = Solder terminal,  
 L1 = Solder terminal 2.8 x 0.5 mm



Product can differ from the current configuration.



Mounting cut-outs [mm]

### Additional Information

- For front dimension 24 x 30 mm

| Terminal  | Part No.           | Component layout | Wiring diagram | Weight   |
|---|--------------------|------------------|----------------|----------|
|  <b>Indicator actuator rectangular</b> |                    |                  |                |          |
| Solder 2.8 x 0.5 mm   | <b>51-050.002F</b> |                  | 1              | 0.004 kg |
| Solder  | <b>51-050.005F</b> |                  | 1              | 0.004 kg |
| Universal 2.0 x 0.5 mm  | <b>51-051.006F</b> |                  | 4              | 0.005 kg |

The component layouts you will find from page 76



# 51 Flush design

## Indicator round, IP 65



Product can differ from the current configuration.



Dimensions [mm]  
 H = Universal terminal 2.0 x 0.5 mm,  
 L = Solder terminal,  
 L1 = Solder terminal 2.8 x 0.5 mm

### Additional Information

- For front dimension Ø 25 mm



Mounting cut-outs [mm]

### Equipment consisting of (schematic overview)



Each Part Number listed below includes all the black components shown in the 3D-drawing.

*To obtain a complete unit, please select the red components from the pages shown.*

| Terminal   | Part No.           | Component layout | Wiring diagram | Weight   |
|--|--------------------|------------------|----------------|----------|
|  <b>Indicator actuator round</b> |                    |                  |                |          |
| Solder 2.8 x 0.5 mm  | <b>51-050.002F</b> |                  | 1              | 0.004 kg |
| Solder   | <b>51-050.005F</b> |                  | 1              | 0.004 kg |
| Universal 2.0 x 0.5 mm   | <b>51-051.006F</b> | 4                | 1              | 0.005 kg |

The component layouts you will find from page 76



## Pushbutton round, IP 65

### Equipment consisting of (schematic overview)



Dimensions [mm]  
 H = Universal terminal 2.0 x 0.5 mm,  
 L = Solder terminal,  
 L1 = Solder terminal 2.8 x 0.5 mm



Product can differ from the current configuration.

### Additional Information

- For front dimension  $\varnothing 25$  mm

Each Part Number listed below includes all the black components shown in the 3D-drawing.

To obtain a complete unit, please select the red components from the pages shown.



Mounting cut-outs [mm]

| Switching system   | Contacts    | Switching action | Terminal               | Part No.            | Component layout | Wiring diagram | Weight   |
|--|-------------|------------------|------------------------|---------------------|------------------|----------------|----------|
|  <b>Illuminated pushbutton actuator round</b> |             |                  |                        |                     |                  |                |          |
| Low-level element  | 1 NC        | B                | Universal 2.0 x 0.5 mm | <b>51-456.036F</b>  | 1                | 1              | 0.006 kg |
|  |             | C                | Universal 2.0 x 0.5 mm | <b>51-486.036F</b>  | 1                | 2              | 0.006 kg |
|  | 1 NC + 1 NO | B                | Universal 2.0 x 0.5 mm | <b>51-453.036F</b>  | 1                | 3              | 0.006 kg |
|  |             | C                | Universal 2.0 x 0.5 mm | <b>51-483.036F</b>  | 1                | 4              | 0.006 kg |
|  | 1 NO        | B                | Universal 2.0 x 0.5 mm | <b>51-455.036F</b>  | 1                | 5              | 0.006 kg |
|  |             | C                | Universal 2.0 x 0.5 mm | <b>51-485.036F</b>  | 1                | 6              | 0.006 kg |
|  | 2 NC        | B                | Universal 2.0 x 0.5 mm | <b>51-452.036F</b>  | 1                | 7              | 0.006 kg |
|  |             | C                | Universal 2.0 x 0.5 mm | <b>51-482.036F</b>  | 1                | 8              | 0.006 kg |
|  | 2 NO        | B                | Universal 2.0 x 0.5 mm | <b>51-451.036F</b>  | 1                | 9              | 0.006 kg |
|  |             | C                | Universal 2.0 x 0.5 mm | <b>51-481.036F</b>  | 1                | 10             | 0.006 kg |
| Snap-action switching element  | 1 NC + 1 NO | B                | Solder 2.8 x 0.5 mm    | <b>51-151.022F</b>  |                  | 11             | 0.007 kg |
|  |             | B                | Solder                 | <b>51-151.0252F</b> |                  | 11             | 0.005 kg |
|  | 1 NC + 1 NO | C                | Solder 2.8 x 0.5 mm    | <b>51-281.022F</b>  |                  | 12             | 0.007 kg |
|  |             | C                | Solder                 | <b>51-281.0252F</b> |                  | 12             | 0.005 kg |
|  | 2 NC + 2 NO | B                | Solder                 | <b>51-152.0252F</b> |                  | 13             | 0.008 kg |
|  |             | C                | Solder                 | <b>51-282.0252F</b> |                  | 14             | 0.008 kg |
|  | 3 NC + 3 NO | B                | Solder                 | <b>51-153.0252F</b> |                  | 15             | 0.010 kg |
|  |             | C                | Solder                 | <b>51-283.0252F</b> |                  | 16             | 0.010 kg |
|  | 4 NC + 4 NO | B                | Solder                 | <b>51-154.0252F</b> |                  | 17             | 0.012 kg |
|  |             | C                | Solder                 | <b>51-284.0252F</b> |                  | 18             | 0.012 kg |

Contacts: NC = Normally closed, NO = Normally open  
 Switching action: B = Momentary, C = Maintained  
 The component layouts you will find from page 76

# 51 Flush design





## Illuminated pushbutton square, IP 65

### Equipment consisting of (schematic overview)



**Lens** page 52



**Single-LED** page 71



**Actuator**



**Front bezel set** page 60



**Fixing nut**

Each Part Number listed below includes all the black components shown in the 3D-drawing.

To obtain a complete unit, please select the red components from the pages shown.

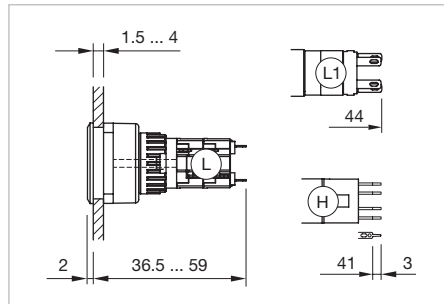

Dimensions [mm]  
 H = Universal terminal 2.0 x 0.5 mm,  
 L = Solder terminal,  
 L1 = Solder terminal 2.8 x 0.5 mm



Product can differ from the current configuration.



Mounting cut-outs [mm]

### Additional Information

- For front dimension 24 x 24 mm

| Switching system   | Contacts    | Switching action | Terminal               | Part No.            | Component layout | Wiring diagram | Weight   |
|--|-------------|------------------|------------------------|---------------------|------------------|----------------|----------|
|  <b>Illuminated pushbutton square</b> |             |                  |                        |                     |                  |                |          |
| Low-level element  | 1 NC        | B                | Universal 2.0 x 0.5 mm | <b>51-456.036F</b>  | 4                | 1              | 0.006 kg |
|  |             | C                | Universal 2.0 x 0.5 mm | <b>51-486.036F</b>  | 4                | 2              | 0.006 kg |
|  | 1 NC + 1 NO | B                | Universal 2.0 x 0.5 mm | <b>51-453.036F</b>  | 4                | 3              | 0.006 kg |
|  |             | C                | Universal 2.0 x 0.5 mm | <b>51-483.036F</b>  | 4                | 4              | 0.006 kg |
|  | 1 NO        | B                | Universal 2.0 x 0.5 mm | <b>51-455.036F</b>  | 4                | 5              | 0.006 kg |
|  |             | C                | Universal 2.0 x 0.5 mm | <b>51-485.036F</b>  | 4                | 6              | 0.006 kg |
|  | 2 NC        | B                | Universal 2.0 x 0.5 mm | <b>51-452.036F</b>  | 4                | 7              | 0.006 kg |
|  |             | C                | Universal 2.0 x 0.5 mm | <b>51-482.036F</b>  | 4                | 8              | 0.006 kg |
|  | 2 NO        | B                | Universal 2.0 x 0.5 mm | <b>51-451.036F</b>  | 4                | 9              | 0.006 kg |
|  |             | C                | Universal 2.0 x 0.5 mm | <b>51-481.036F</b>  | 4                | 10             | 0.006 kg |
| Snap-action switching element  | 1 NC + 1 NO | B                | Solder 2.8 x 0.5 mm    | <b>51-151.022F</b>  |                  | 11             | 0.007 kg |
|  |             | B                | Solder                 | <b>51-151.0252F</b> |                  | 12             | 0.005 kg |
|  |             | C                | Solder 2.8 x 0.5 mm    | <b>51-281.022F</b>  |                  | 13             | 0.007 kg |
|  |             | C                | Solder                 | <b>51-281.0252F</b> |                  | 14             | 0.005 kg |
|  | 2 NC + 2 NO | B                | Solder                 | <b>51-152.0252F</b> |                  | 15             | 0.008 kg |
|  |             | C                | Solder                 | <b>51-282.0252F</b> |                  | 16             | 0.008 kg |
|  | 3 NC + 3 NO | B                | Solder                 | <b>51-153.0252F</b> |                  | 17             | 0.010 kg |
|  |             | C                | Solder                 | <b>51-283.0252F</b> |                  | 18             | 0.010 kg |
|  | 4 NC + 4 NO | B                | Solder                 | <b>51-154.0252F</b> |                  | 19             | 0.012 kg |
|  |             | C                | Solder                 | <b>51-284.0252F</b> |                  | 20             | 0.012 kg |

Contacts: NC = Normally closed, NO = Normally open  
 Switching action: B = Momentary, C = Maintain  
 The component layouts you will find from page 76

# 51 Flush design



## Illuminated pushbutton rectangular, IP 65

### Equipment consisting of (schematic overview)



**Lens** page 52



**Single-LED** page 71



**Actuator**



**Front bezel set** page 60



**Fixing nut**

Each Part Number listed below includes all the black components shown in the 3D-drawing.

To obtain a complete unit, please select the red components from the pages shown.



Dimensions [mm]  
 H = Universal terminal 2.0 x 0.5 mm,  
 L = Solder terminal,  
 L1 = Solder terminal 2.8 x 0.5 mm



Product can differ from the current configuration.



Mounting cut-outs [mm]

### Additional Information

- For front dimension 24 x 30 mm

| Switching system   | Contacts    | Switching action | Terminal               | Part No.            | Component layout | Wiring diagram | Weight   |
|--|-------------|------------------|------------------------|---------------------|------------------|----------------|----------|
|  <b>Illuminated pushbutton actuator rectangular</b> |             |                  |                        |                     |                  |                |          |
| Low-level element  | 1 NC        | B                | Universal 2.0 x 0.5 mm | <b>51-456.036F</b>  | 4                | 1              | 0.006 kg |
|  |             | C                | Universal 2.0 x 0.5 mm | <b>51-486.036F</b>  | 4                | 2              | 0.006 kg |
|  | 1 NC + 1 NO | B                | Universal 2.0 x 0.5 mm | <b>51-453.036F</b>  | 4                | 3              | 0.006 kg |
|  |             | C                | Universal 2.0 x 0.5 mm | <b>51-483.036F</b>  | 4                | 4              | 0.006 kg |
|  | 1 NO        | B                | Universal 2.0 x 0.5 mm | <b>51-455.036F</b>  | 4                | 5              | 0.006 kg |
|  |             | C                | Universal 2.0 x 0.5 mm | <b>51-485.036F</b>  | 4                | 6              | 0.006 kg |
|  | 2 NC        | B                | Universal 2.0 x 0.5 mm | <b>51-452.036F</b>  | 4                | 7              | 0.006 kg |
|  |             | C                | Universal 2.0 x 0.5 mm | <b>51-482.036F</b>  | 4                | 8              | 0.006 kg |
|  | 2 NO        | B                | Universal 2.0 x 0.5 mm | <b>51-451.036F</b>  | 4                | 9              | 0.006 kg |
|  |             | C                | Universal 2.0 x 0.5 mm | <b>51-481.036F</b>  | 4                | 10             | 0.006 kg |
| Snap-action switching element  | 1 NC + 1 NO | B                | Solder 2.8 x 0.5 mm    | <b>51-151.022F</b>  |                  | 11             | 0.007 kg |
|  |             | B                | Solder                 | <b>51-151.0252F</b> |                  | 12             | 0.005 kg |
|  |             | C                | Solder 2.8 x 0.5 mm    | <b>51-281.022F</b>  |                  | 13             | 0.007 kg |
|  |             | C                | Solder                 | <b>51-281.0252F</b> |                  | 14             | 0.005 kg |
|  | 2 NC + 2 NO | B                | Solder                 | <b>51-152.0252F</b> |                  | 15             | 0.008 kg |
|  |             | C                | Solder                 | <b>51-282.0252F</b> |                  | 16             | 0.008 kg |
|  | 3 NC + 3 NO | B                | Solder                 | <b>51-153.0252F</b> |                  | 17             | 0.010 kg |
|  |             | C                | Solder                 | <b>51-283.0252F</b> |                  | 18             | 0.010 kg |
|  | 4 NC + 4 NO | B                | Solder                 | <b>51-154.0252F</b> |                  | 19             | 0.012 kg |
|  |             | C                | Solder                 | <b>51-284.0252F</b> |                  | 20             | 0.012 kg |

Contacts: NC = Normally closed, NO = Normally open  
 Switching action: B = Momentary, C = Maintain  
 The component layouts you will find from page 76

# 51 Flush design

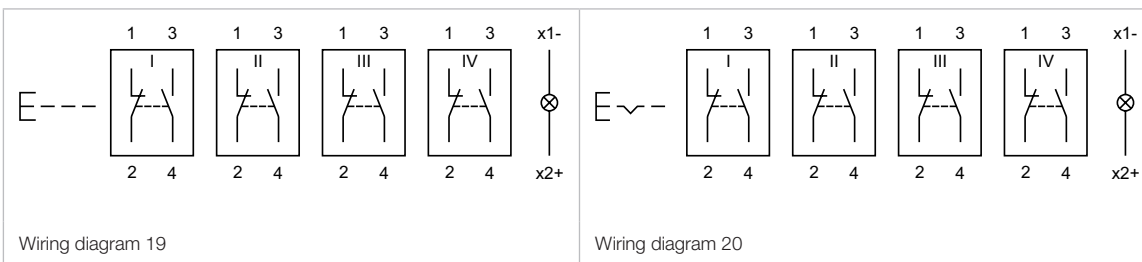

## Illuminated pushbutton round, IP 65

### Equipment consisting of (schematic overview)



Each Part Number listed below includes all the black components shown in the 3D-drawing.

To obtain a complete unit, please select the red components from the pages shown.



Dimensions [mm]  
 H = Universal terminal 2.0 x 0.5 mm,  
 L = Solder terminal,  
 L1 = Solder terminal 2.8 x 0.5 mm



Mounting cut-outs [mm]



Product can differ from the current configuration.

### Additional Information

- For front dimension  $\varnothing$  25 mm

| Switching system  | Contacts    | Switching action | Terminal               | Part No.            | Component layout | Wiring diagram | Weight   |
|---|-------------|------------------|------------------------|---------------------|------------------|----------------|----------|
|  <b>Illuminated pushbutton round</b> |             |                  |                        |                     |                  |                |          |
| Low-level element   | 1 NC        | B                | Universal 2.0 x 0.5 mm | <b>51-456.036F</b>  | 4                | 1              | 0.006 kg |
|   |             | C                | Universal 2.0 x 0.5 mm | <b>51-486.036F</b>  | 4                | 2              | 0.006 kg |
|   | 1 NC + 1 NO | B                | Universal 2.0 x 0.5 mm | <b>51-453.036F</b>  | 4                | 3              | 0.006 kg |
|   |             | C                | Universal 2.0 x 0.5 mm | <b>51-483.036F</b>  | 4                | 4              | 0.006 kg |
|   | 1 NO        | B                | Universal 2.0 x 0.5 mm | <b>51-455.036F</b>  | 4                | 5              | 0.006 kg |
|   |             | C                | Universal 2.0 x 0.5 mm | <b>51-485.036F</b>  | 4                | 6              | 0.006 kg |
|   | 2 NC        | B                | Universal 2.0 x 0.5 mm | <b>51-452.036F</b>  | 4                | 7              | 0.006 kg |
|   |             | C                | Universal 2.0 x 0.5 mm | <b>51-482.036F</b>  | 4                | 8              | 0.006 kg |
|   | 2 NO        | B                | Universal 2.0 x 0.5 mm | <b>51-451.036F</b>  | 4                | 9              | 0.006 kg |
|   |             | C                | Universal 2.0 x 0.5 mm | <b>51-481.036F</b>  | 4                | 10             | 0.006 kg |
| Snap-action switching element   | 1 NC + 1 NO | B                | Solder 2.8 x 0.5 mm    | <b>51-151.022F</b>  |                  | 11             | 0.007 kg |
|   |             | B                | Solder                 | <b>51-151.0252F</b> |                  | 12             | 0.005 kg |
|   |             | C                | Solder 2.8 x 0.5 mm    | <b>51-281.022F</b>  |                  | 13             | 0.007 kg |
|   |             | C                | Solder                 | <b>51-281.0252F</b> |                  | 14             | 0.005 kg |
|   | 2 NC + 2 NO | B                | Solder                 | <b>51-152.0252F</b> |                  | 15             | 0.008 kg |
|   |             | C                | Solder                 | <b>51-282.0252F</b> |                  | 16             | 0.008 kg |
|   | 3 NC + 3 NO | B                | Solder                 | <b>51-153.0252F</b> |                  | 17             | 0.010 kg |
|   |             | C                | Solder                 | <b>51-283.0252F</b> |                  | 18             | 0.010 kg |
|   | 4 NC + 4 NO | B                | Solder                 | <b>51-154.0252F</b> |                  | 19             | 0.012 kg |
|   |             | C                | Solder                 | <b>51-284.0252F</b> |                  | 20             | 0.012 kg |

Contacts: NC = Normally closed, NO = Normally open  
 Switching action: B = Momentary, C = Maintain  
 The component layouts you will find from page 76

# 51 Flush design



## Keylock switch 2 positions, IP 65

### Equipment consisting of (schematic overview)



Each Part Number listed below includes all the black components shown in the 3D-drawing.

To obtain a complete unit, please select the red components from the pages shown.



Dimensions [mm]  
 H = Universal terminal 2.0 x 0.5 mm,  
 L = Solder terminal,  
 L1 = Solder terminal 2.8 x 0.5 mm



Product can differ from the current configuration.



Mounting cut-outs [mm]

### Additional Information

- For front dimensions 24 x 24 mm, 24 x 30 mm, Ø 25 mm
- Front plastic black
- The standard lock: DOM 311
- Two keys are supplied with each key lock switch
- Optional lock numbers on request



Switching positions (A = Rest, B = Momentary, C = Maintained)

| Switching system   | Contacts                      | Switching action    | Switching angle | Key remove | Terminal               | Part No.             | Component layout     | Wiring diagram | Weight   |          |
|--|-------------------------------|---------------------|-----------------|------------|------------------------|----------------------|----------------------|----------------|----------|----------|
|  <p><b>Keylock switch actuator 2 positions square, flush design</b></p> | 1 NC + 1 NO                   | A - B               | B = 42°         | A          | Universal 2.0 x 0.5 mm | <b>51-458.036DF</b>  | 4                    | 1              | 0.027 kg |          |
|  | 2 NO                          | A - B               | B = 42°         | A          | Universal 2.0 x 0.5 mm | <b>51-457.036DF</b>  | 4                    | 2              | 0.027 kg |          |
|  | 1 NC + 1 NO                   | A - C               | C = 90°         | A          | Universal 2.0 x 0.5 mm | <b>51-445.036DF</b>  | 4                    | 7              | 0.027 kg |          |
|  |                               |                     |                 | C          | Universal 2.0 x 0.5 mm | <b>51-448.036DF</b>  | 4                    | 7              | 0.027 kg |          |
|  |                               |                     |                 | A + C      | Universal 2.0 x 0.5 mm | <b>51-442.036DF</b>  | 4                    | 7              | 0.027 kg |          |
|  | 2 NO                          | A - C               | C = 90°         | A          | Universal 2.0 x 0.5 mm | <b>51-444.036DF</b>  | 4                    | 8              | 0.027 kg |          |
|  |                               |                     |                 | C          | Universal 2.0 x 0.5 mm | <b>51-447.036DF</b>  | 4                    | 8              | 0.027 kg |          |
|  |                               |                     |                 | A + C      | Universal 2.0 x 0.5 mm | <b>51-441.036DF</b>  | 4                    | 8              | 0.027 kg |          |
|  | Snap-action switching element | 1 NC + 1 NO         | A - B           | B = 42°    | A                      | Solder 2.8 x 0.5 mm  | <b>51-145.022DF</b>  |                | 3        | 0.027 kg |
|  |                               |                     |                 |            | A                      | Solder               | <b>51-145.025D2F</b> |                | 3        | 0.027 kg |
| 2 NC + 2 NO  |                               | A - B               | B = 42°         | A          | Solder                 | <b>51-146.025D2F</b> |                      | 4              | 0.027 kg |          |
| 3 NC + 3 NO  |                               | A - B               | B = 42°         | A          | Solder                 | <b>51-147.025D2F</b> |                      | 5              | 0.027 kg |          |
| 1 NC + 1 NO  |                               | A - C               | C = 90°         | A          | Solder                 | <b>51-255.025D2F</b> |                      | 9              | 0.027 kg |          |
|  |                               |                     |                 | C          | Solder                 | <b>51-355.025D2F</b> |                      | 9              | 0.027 kg |          |
|  |                               |                     |                 | A + C      | Solder                 | <b>51-155.025D2F</b> |                      | 9              | 0.027 kg |          |
| A  | Solder 2.8 x 0.5 mm           | <b>51-255.022DF</b> |                 | 9          | 0.027 kg               |                      |                      |                |          |          |

# 51 Flush design

| Switching system              | Contacts    | Switching action | Switching angle | Key remove | Terminal            | Part No.             | Component layout | Wiring diagram | Weight   |
|-------------------------------|-------------|------------------|-----------------|------------|---------------------|----------------------|------------------|----------------|----------|
| Snap-action switching element | 1 NC + 1 NO | A - C            | C = 90°         | C          | Solder 2.8 x 0.5 mm | <b>51-355.022DF</b>  |                  | 9              | 0.027 kg |
|                               |             |                  |                 | A + C      | Solder 2.8 x 0.5 mm | <b>51-155.022DF</b>  |                  | 9              | 0.027 kg |
|                               | 2 NC + 2 NO | A - C            | C = 90°         | A          | Solder              | <b>51-256.025D2F</b> |                  | 10             | 0.027 kg |
|                               |             |                  |                 | C          | Solder              | <b>51-356.025D2F</b> |                  | 10             | 0.027 kg |
|                               |             |                  |                 | A + C      | Solder              | <b>51-156.025D2F</b> |                  | 10             | 0.027 kg |
|                               |             |                  |                 | A          | Solder              | <b>51-257.025D2F</b> |                  | 11             | 0.027 kg |
|                               | 3 NC + 3 NO | A - C            | C = 90°         | C          | Solder              | <b>51-357.025D2F</b> |                  | 11             | 0.027 kg |
|                               |             |                  |                 | A + C      | Solder              | <b>51-157.025D2F</b> |                  | 11             | 0.027 kg |
|                               |             |                  |                 | A          | Solder              | <b>51-258.025D2F</b> |                  | 12             | 0.027 kg |
|                               | 4 NC + 4 NO | A - C            | C = 90°         | C          | Solder              | <b>51-358.025D2F</b> |                  | 12             | 0.027 kg |
|                               |             |                  |                 | A + C      | Solder              | <b>51-158.025D2F</b> |                  | 12             | 0.027 kg |



## Keylock switch actuator 2 positions rectangular, flush design

|                   |                               |             |         |         |                        |                      |                     |    |          |
|-------------------|-------------------------------|-------------|---------|---------|------------------------|----------------------|---------------------|----|----------|
| Low-level element | 1 NC + 1 NO                   | A - B       | B = 42° | A       | Universal 2.0 x 0.5 mm | <b>51-428.036DF</b>  | 4                   | 1  | 0.029 kg |
|                   | 2 NO                          | A - B       | B = 42° | A       | Universal 2.0 x 0.5 mm | <b>51-427.036DF</b>  | 4                   | 2  | 0.029 kg |
|                   | 1 NC + 1 NO                   | A - C       | C = 90° | A       | Universal 2.0 x 0.5 mm | <b>51-405.036DF</b>  | 4                   | 7  | 0.029 kg |
|                   |                               |             |         | C       | Universal 2.0 x 0.5 mm | <b>51-408.036DF</b>  | 4                   | 7  | 0.029 kg |
|                   |                               |             |         | A + C   | Universal 2.0 x 0.5 mm | <b>51-402.036DF</b>  | 4                   | 7  | 0.029 kg |
|                   | 2 NO                          | A - C       | C = 90° | A       | Universal 2.0 x 0.5 mm | <b>51-404.036DF</b>  | 4                   | 8  | 0.029 kg |
|                   |                               |             |         | C       | Universal 2.0 x 0.5 mm | <b>51-407.036DF</b>  | 4                   | 8  | 0.029 kg |
|                   |                               |             |         | A + C   | Universal 2.0 x 0.5 mm | <b>51-401.036DF</b>  | 4                   | 8  | 0.029 kg |
|                   | Snap-action switching element | 1 NC + 1 NO | A - B   | B = 42° | A                      | Solder 2.8 x 0.5 mm  | <b>51-495.022DF</b> |    | 3        |
| A                 |                               |             |         |         | Solder                 | <b>51-495.025D2F</b> |                     | 3  | 0.029 kg |
| 2 NC + 2 NO       |                               | A - B       | B = 42° | A       | Solder                 | <b>51-496.025D2F</b> |                     | 4  | 0.029 kg |
| 3 NC + 3 NO       |                               | A - B       | B = 42° | A       | Solder                 | <b>51-497.025D2F</b> |                     | 5  | 0.029 kg |
| 4 NC + 4 NO       |                               | A - B       | B = 42° | A       | Solder                 | <b>51-498.025D2F</b> |                     | 6  | 0.029 kg |
| 1 NC + 1 NO       |                               | A - C       | C = 90° | A       | Solder                 | <b>51-295.025D2F</b> |                     | 9  | 0.029 kg |
|                   |                               |             |         | C       | Solder                 | <b>51-395.025D2F</b> |                     | 9  | 0.029 kg |
|                   |                               |             |         | A + C   | Solder                 | <b>51-195.025D2F</b> |                     | 9  | 0.029 kg |
|                   |                               |             |         | A       | Solder 2.8 x 0.5 mm    | <b>51-295.022DF</b>  |                     | 9  | 0.029 kg |
|                   |                               |             |         | C       | Solder 2.8 x 0.5 mm    | <b>51-395.022DF</b>  |                     | 9  | 0.029 kg |
|                   |                               |             |         | A + C   | Solder 2.8 x 0.5 mm    | <b>51-195.022DF</b>  |                     | 9  | 0.029 kg |
| 2 NC + 2 NO       |                               | A - C       | C = 90° | A       | Solder                 | <b>51-296.025D2F</b> |                     | 10 | 0.029 kg |
|                   |                               |             |         | C       | Solder                 | <b>51-396.025D2F</b> |                     | 10 | 0.029 kg |
|                   |                               |             |         | A + C   | Solder                 | <b>51-196.025D2F</b> |                     | 10 | 0.029 kg |
| 3 NC + 3 NO       |                               | A - C       | C = 90° | A       | Solder                 | <b>51-297.025D2F</b> |                     | 11 | 0.029 kg |
|                   |                               |             |         | C       | Solder                 | <b>51-397.025D2F</b> |                     | 11 | 0.029 kg |
|                   |                               |             |         | A + C   | Solder                 | <b>51-197.025D2F</b> |                     | 11 | 0.029 kg |
| 4 NC + 4 NO       |                               | A - C       | C = 90° | A       | Solder                 | <b>51-298.025D2F</b> |                     | 12 | 0.029 kg |
|                   |                               |             |         | C       | Solder                 | <b>51-398.025D2F</b> |                     | 12 | 0.029 kg |
|                   |                               |             |         | A + C   | Solder                 | <b>51-198.025D2F</b> |                     | 12 | 0.029 kg |



| Switching system  | Contacts                      | Switching action    | Switching angle     | Key remove | Terminal               | Part No.             | Component layout    | Wiring diagram | Weight   |             |                     |                     |       |        |                      |   |                     |                     |
|---|-------------------------------|---------------------|---------------------|------------|------------------------|----------------------|---------------------|----------------|----------|-------------|---------------------|---------------------|-------|--------|----------------------|---|---------------------|---------------------|
|  <p><b>Keylock switch actuator 2 positions round, flush design</b></p> |                               |                     |                     |            |                        |                      |                     |                |          |             |                     |                     |       |        |                      |   |                     |                     |
| Low-level element   | 1 NC + 1 NO                   | A - B               | B = 42°             | A          | Universal 2.0 x 0.5 mm | <b>51-438.036DF</b>  | 4                   | 1              | 0.026 kg |             |                     |                     |       |        |                      |   |                     |                     |
|   | 2 NO                          | A - B               | B = 42°             | A          | Universal 2.0 x 0.5 mm | <b>51-437.036DF</b>  | 4                   | 2              | 0.026 kg |             |                     |                     |       |        |                      |   |                     |                     |
|   | 1 NC + 1 NO                   | A - C               | C = 90°             | A          | Universal 2.0 x 0.5 mm | <b>51-415.036DF</b>  | 4                   | 7              | 0.026 kg |             |                     |                     |       |        |                      |   |                     |                     |
|   |                               |                     |                     | C          | Universal 2.0 x 0.5 mm | <b>51-418.036DF</b>  | 4                   | 7              | 0.026 kg |             |                     |                     |       |        |                      |   |                     |                     |
|   |                               |                     |                     | A + C      | Universal 2.0 x 0.5 mm | <b>51-412.036DF</b>  | 4                   | 7              | 0.026 kg |             |                     |                     |       |        |                      |   |                     |                     |
|   | 2 NO                          | A - C               | C = 90°             | A          | Universal 2.0 x 0.5 mm | <b>51-414.036DF</b>  | 4                   | 8              | 0.026 kg |             |                     |                     |       |        |                      |   |                     |                     |
|   |                               |                     |                     | C          | Universal 2.0 x 0.5 mm | <b>51-417.036DF</b>  | 4                   | 8              | 0.026 kg |             |                     |                     |       |        |                      |   |                     |                     |
|   |                               |                     |                     | A + C      | Universal 2.0 x 0.5 mm | <b>51-411.036DF</b>  | 4                   | 8              | 0.026 kg |             |                     |                     |       |        |                      |   |                     |                     |
|   | Snap-action switching element | 1 NC + 1 NO         | A - B               | B = 42°    | A                      | Solder 2.8 x 0.5 mm  | <b>51-141.022DF</b> |                | 3        | 0.026 kg    |                     |                     |       |        |                      |   |                     |                     |
| A   |                               |                     |                     |            | Solder                 | <b>51-141.025D2F</b> |                     | 3              | 0.026 kg |             |                     |                     |       |        |                      |   |                     |                     |
| 2 NC + 2 NO   |                               | A - B               | B = 42°             | A          | Solder                 | <b>51-142.025D2F</b> |                     | 4              | 0.026 kg |             |                     |                     |       |        |                      |   |                     |                     |
| 3 NC + 3 NO   |                               | A - B               | B = 42°             | A          | Solder                 | <b>51-143.025D2F</b> |                     | 5              | 0.026 kg |             |                     |                     |       |        |                      |   |                     |                     |
| 4 NC + 4 NO   |                               | A - B               | B = 42°             | A          | Solder                 | <b>51-144.025D2F</b> |                     | 6              | 0.026 kg |             |                     |                     |       |        |                      |   |                     |                     |
|   |                               |                     |                     |            |                        |                      |                     |                |          | 1 NC + 1 NO | A - C               | C = 90°             | A     | Solder | <b>51-235.025D2F</b> |   | 9                   | 0.026 kg            |
|   |                               |                     |                     |            |                        |                      |                     |                |          |             |                     |                     | C     | Solder | <b>51-335.025D2F</b> |   | 9                   | 0.026 kg            |
|   |                               |                     |                     |            |                        |                      |                     |                |          |             |                     |                     | A + C | Solder | <b>51-135.025D2F</b> |   | 9                   | 0.026 kg            |
|   |                               |                     |                     |            |                        |                      |                     |                |          | A           | Solder 2.8 x 0.5 mm | <b>51-235.022DF</b> |       | 9      | 0.026 kg             |   |                     |                     |
|   |                               |                     |                     |            |                        |                      |                     |                |          |             |                     |                     |       |        |                      | C | Solder 2.8 x 0.5 mm | <b>51-335.022DF</b> |
| A + C   |                               | Solder 2.8 x 0.5 mm | <b>51-135.022DF</b> |            | 9                      | 0.026 kg             |                     |                |          |             |                     |                     |       |        |                      |   |                     |                     |
| 2 NC + 2 NO   |                               | A - C               | C = 90°             | A          | Solder                 | <b>51-236.025D2F</b> |                     | 10             | 0.026 kg |             |                     |                     |       |        |                      |   |                     |                     |
|   |                               |                     |                     | C          | Solder                 | <b>51-336.025D2F</b> |                     | 10             | 0.026 kg |             |                     |                     |       |        |                      |   |                     |                     |
|   |                               |                     |                     | A + C      | Solder                 | <b>51-136.025D2F</b> |                     | 10             | 0.026 kg |             |                     |                     |       |        |                      |   |                     |                     |
| 3 NC + 3 NO   |                               | A - C               | C = 90°             | A          | Solder                 | <b>51-237.025D2F</b> |                     | 11             | 0.026 kg |             |                     |                     |       |        |                      |   |                     |                     |
|   |                               |                     |                     | C          | Solder                 | <b>51-337.025D2F</b> |                     | 11             | 0.026 kg |             |                     |                     |       |        |                      |   |                     |                     |
|   |                               |                     |                     | A + C      | Solder                 | <b>51-137.025D2F</b> |                     | 11             | 0.026 kg |             |                     |                     |       |        |                      |   |                     |                     |
| 4 NC + 4 NO   |                               | A - C               | C = 90°             | A          | Solder                 | <b>51-238.025D2F</b> |                     | 12             | 0.026 kg |             |                     |                     |       |        |                      |   |                     |                     |
|   |                               |                     |                     | C          | Solder                 | <b>51-338.025D2F</b> |                     | 12             | 0.026 kg |             |                     |                     |       |        |                      |   |                     |                     |
|   |                               |                     |                     | A + C      | Solder                 | <b>51-138.025D2F</b> |                     | 12             | 0.026 kg |             |                     |                     |       |        |                      |   |                     |                     |

Contacts: NC = Normally closed, NO = Normally open  
 Switching action: A = Rest, B = Momentary, C = Maintain  
 The component layouts you will find from page 76

# 51 Flush design



## Keylock switch 3 positions, IP 65

### Equipment consisting of (schematic overview)



Each Part Number listed below includes all the black components shown in the 3D-drawing.

To obtain a complete unit, please select the red components from the page s shown.



Dimensions [mm]



Mounting cut-outs [mm]



Product can differ from the current configuration.

### Additional Information

- For front dimensions 24 x 24 mm, 24 x 30 mm, Ø 25 mm
- Front plastic black
- The standard lock: DOM 311
- Two keys are supplied with each key lock switch
- Optional lock numbers on request



Switching positions (A = Rest, B = Momentary, C = Maintained)

| Switching system   | Contacts    | Switching action | Switching angle  | Key remove | Terminal            | Part No.            | Wiring diagram | Weight   |
|--|-------------|------------------|------------------|------------|---------------------|---------------------|----------------|----------|
|  <p><b>Keylock switch actuator 3 positions square, flush design</b></p> | 2 NC + 2 NO | B - A - B        | B = 42° / 42°    | A          | Solder 2.8 x 0.5 mm | <b>51-384.022DF</b> | 1              | 0.027 kg |
|  |             | C - A - B        | C = 90°, B = 42° | A          | Solder 2.8 x 0.5 mm | <b>51-387.022DF</b> | 2              | 0.027 kg |
|  |             |                  |                  | C + A      | Solder 2.8 x 0.5 mm | <b>51-388.022DF</b> | 2              | 0.027 kg |
|  |             | B - A - C        | B = 42°, C = 90° | A          | Solder 2.8 x 0.5 mm | <b>51-385.022DF</b> | 3              | 0.027 kg |
|  |             |                  |                  | A + C      | Solder 2.8 x 0.5 mm | <b>51-386.022DF</b> | 3              | 0.027 kg |
|  |             | C - A - C        | C = 90° / 90°    | A          | Solder 2.8 x 0.5 mm | <b>51-381.022DF</b> | 4              | 0.027 kg |
|  |             |                  |                  | C + A + C  | Solder 2.8 x 0.5 mm | <b>51-382.022DF</b> | 4              | 0.027 kg |
|  |             |                  |                  | C + C      | Solder 2.8 x 0.5 mm | <b>51-383.022DF</b> | 4              | 0.027 kg |

# 51 Flush design

| Switching system | Contacts | Switching action | Switching angle | Key remove | Terminal | Part No. | Wiring diagram | Weight |
|------------------|----------|------------------|-----------------|------------|----------|----------|----------------|--------|
|------------------|----------|------------------|-----------------|------------|----------|----------|----------------|--------|



### Keylock switch actuator 3 positions rectangular, flush design

|                               |             |           |                  |           |                     |                     |   |          |
|-------------------------------|-------------|-----------|------------------|-----------|---------------------|---------------------|---|----------|
| Snap-action switching element | 2 NC + 2 NO | B - A - B | B = 42° / 42°    | A         | Solder 2.8 x 0.5 mm | <b>51-364.022DF</b> | 1 | 0.027 kg |
|                               |             | C - A - B | C = 90°, B = 42° | A         | Solder 2.8 x 0.5 mm | <b>51-367.022DF</b> | 2 | 0.027 kg |
|                               |             |           |                  | C + A     | Solder 2.8 x 0.5 mm | <b>51-368.022DF</b> | 2 | 0.027 kg |
|                               |             | B - A - C | B = 42°, C = 90° | A         | Solder 2.8 x 0.5 mm | <b>51-365.022DF</b> | 3 | 0.027 kg |
|                               |             |           |                  | A + C     | Solder 2.8 x 0.5 mm | <b>51-366.022DF</b> | 3 | 0.027 kg |
|                               |             | C - A - C | C = 90° / 90°    | A         | Solder 2.8 x 0.5 mm | <b>51-361.022DF</b> | 4 | 0.027 kg |
|                               |             |           |                  | C + A + C | Solder 2.8 x 0.5 mm | <b>51-362.022DF</b> | 4 | 0.027 kg |
|                               |             |           |                  | C + C     | Solder 2.8 x 0.5 mm | <b>51-363.022DF</b> | 4 | 0.027 kg |



### Keylock switch actuator 3 positions round, flush design

|                               |             |           |                  |           |                     |                     |   |          |
|-------------------------------|-------------|-----------|------------------|-----------|---------------------|---------------------|---|----------|
| Snap-action switching element | 2 NC + 2 NO | B - A - B | B = 42° / 42°    | A         | Solder 2.8 x 0.5 mm | <b>51-374.022DF</b> | 1 | 0.027 kg |
|                               |             | C - A - B | C = 90°, B = 42° | A         | Solder 2.8 x 0.5 mm | <b>51-377.022DF</b> | 2 | 0.027 kg |
|                               |             |           |                  | C + A     | Solder 2.8 x 0.5 mm | <b>51-378.022DF</b> | 2 | 0.027 kg |
|                               |             | B - A - C | B = 42°, C = 90° | A         | Solder 2.8 x 0.5 mm | <b>51-375.022DF</b> | 3 | 0.027 kg |
|                               |             |           |                  | A + C     | Solder 2.8 x 0.5 mm | <b>51-376.022DF</b> | 3 | 0.027 kg |
|                               |             | C - A - C | C = 90° / 90°    | A         | Solder 2.8 x 0.5 mm | <b>51-371.022DF</b> | 4 | 0.027 kg |
|                               |             |           |                  | C + A + C | Solder 2.8 x 0.5 mm | <b>51-372.022DF</b> | 4 | 0.027 kg |
|                               |             |           |                  | C + C     | Solder 2.8 x 0.5 mm | <b>51-373.022DF</b> | 4 | 0.027 kg |

Contacts: NC = Normally closed, NO = Normally open  
Switching action: A = Rest, B = Momentary, C = Maintain



## Selector switch 2 positions square, IP 65

### Equipment consisting of (schematic overview)



Each Part Number listed below includes all the black components shown in the 3D-drawing.

To obtain a complete unit, please select the red components from the pages shown.



Dimensions [mm]  
 H = Universal terminal 2.0 x 0.5 mm,  
 L = Solder terminal,  
 L1 = Solder terminal 2.8 x 0.5 mm



Product can differ from the current configuration.

### Additional Information

- For front dimension 24 x 24 mm
- Illuminative

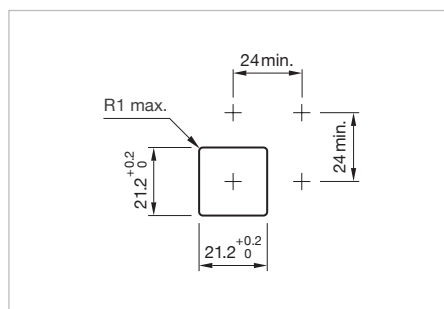

Mounting cut-outs [mm]



Switching positions (A = Rest, B = Momentary, C = Maintained)

| Switching system   | Contacts    | Switching action | Switching angle | Terminal               | Part No.           | Component layout | Wiring diagram | Weight   |
|--|-------------|------------------|-----------------|------------------------|--------------------|------------------|----------------|----------|
|  <h3>Selector switch actuator 2 positions square, flush design</h3> |             |                  |                 |                        |                    |                  |                |          |
| Low-level element  | 1 NC        | A - B            | B = 42°         | Universal 2.0 x 0.5 mm | <b>52-436.036</b>  | 4                | 1              | 0.007 kg |
|  | 1 NC + 1 NO | A - B            | B = 42°         | Universal 2.0 x 0.5 mm | <b>52-433.036</b>  | 4                | 2              | 0.007 kg |
|  | 1 NO        | A - B            | B = 42°         | Universal 2.0 x 0.5 mm | <b>52-435.036</b>  | 4                | 3              | 0.007 kg |
|  | 2 NC        | A - B            | B = 42°         | Universal 2.0 x 0.5 mm | <b>52-432.036</b>  | 4                | 4              | 0.007 kg |
|  | 2 NO        | A - B            | B = 42°         | Universal 2.0 x 0.5 mm | <b>52-431.036</b>  | 4                | 5              | 0.007 kg |
|  | 1 NC        | A - C            | C = 90°         | Universal 2.0 x 0.5 mm | <b>52-476.036</b>  | 4                | 11             | 0.007 kg |
|  | 1 NC + 1 NO | A - C            | C = 90°         | Universal 2.0 x 0.5 mm | <b>52-473.036</b>  | 4                | 12             | 0.007 kg |
|  | 1 NO        | A - C            | C = 90°         | Universal 2.0 x 0.5 mm | <b>52-475.036</b>  | 4                | 13             | 0.007 kg |
|  | 2 NC        | A - C            | C = 90°         | Universal 2.0 x 0.5 mm | <b>52-472.036</b>  | 4                | 14             | 0.007 kg |
|  | 2 NO        | A - C            | C = 90°         | Universal 2.0 x 0.5 mm | <b>52-471.036</b>  | 4                | 15             | 0.007 kg |
| Snap-action switching element  | 1 NC + 1 NO | A - B            | B = 42°         | Solder                 | <b>52-131.0252</b> | 6                | 0.006 kg       |          |
|  |             |                  |                 | Solder 2.8 x 0.5 mm    | <b>52-131.022</b>  | 7                | 0.006 kg       |          |
|  | 2 NC + 2 NO | A - B            | B = 42°         | Solder                 | <b>52-132.0252</b> | 8                | 0.006 kg       |          |
|  | 3 NC + 3 NO | A - B            | B = 42°         | Solder                 | <b>52-133.0252</b> | 9                | 0.006 kg       |          |
|  | 4 NC + 4 NO | A - B            | B = 42°         | Solder                 | <b>52-134.0252</b> | 10               | 0.006 kg       |          |
|  | 1 NC + 1 NO | A - C            | C = 90°         | Solder                 | <b>52-271.0252</b> | 16               | 0.006 kg       |          |
| Solder 2.8 x 0.5 mm  |             |                  |                 | <b>52-271.022</b>      | 17                 | 0.006 kg         |                |          |

# 51 Flush design

| Switching system              | Contacts    | Switching action | Switching angle | Terminal | Part No.           | Component layout | Wiring diagram | Weight   |
|-------------------------------|-------------|------------------|-----------------|----------|--------------------|------------------|----------------|----------|
| Snap-action switching element | 2 NC + 2 NO | A - C            | C = 90°         | Solder   | <b>52-272.0252</b> |                  | 18             | 0.006 kg |
|                               | 3 NC + 3 NO | A - C            | C = 90°         | Solder   | <b>52-273.0252</b> |                  | 19             | 0.006 kg |
|                               | 4 NC + 4 NO | A - C            | C = 90°         | Solder   | <b>52-274.0252</b> |                  | 20             | 0.006 kg |

Contacts: NC = Normally closed, NO = Normally open  
 Switching action: A = Rest, B = Momentary, C = Maintain  
 The component layouts you will find from page 76





# 51 Flush design

## Selector switch 2 positions round, IP 65



Product can differ from the current configuration.



Dimensions [mm]  
 H = Universal terminal 2.0 x 0.5 mm,  
 L = Solder terminal,  
 L1 = Solder terminal 2.8 x 0.5 mm

### Additional Information

- For front dimension Ø 25 mm
- Illuminative



Mounting cut-outs [mm]

### Equipment consisting of (schematic overview)

- Lever** page 58
- Single-LED** page 71
- Actuator**
- Front bezel set** page 63
- Anti-twist ring**
- Part of front bezel set**
- Fixing nut**

Each Part Number listed below includes all the black components shown in the 3D-drawing.

*To obtain a complete unit, please select the red components from the pages shown.*

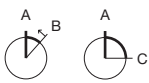

Switching positions (A = Rest, B = Momentary, C = Maintained)

| Switching system  | Contacts    | Switching action | Switching angle | Terminal               | Part No.           | Component layout | Wiring diagram | Weight   |
|---|-------------|------------------|-----------------|------------------------|--------------------|------------------|----------------|----------|
| <b>Selector switch actuator 2 positions round, flush design</b> |             |                  |                 |                        |                    |                  |                |          |
| Low-level element   | 1 NC        | A - B            | B = 42°         | Universal 2.0 x 0.5 mm | <b>52-436.036</b>  | 4                | 1              | 0.007 kg |
|   | 1 NC + 1 NO | A - B            | B = 42°         | Universal 2.0 x 0.5 mm | <b>52-433.036</b>  | 4                | 2              | 0.007 kg |
|   | 1 NO        | A - B            | B = 42°         | Universal 2.0 x 0.5 mm | <b>52-435.036</b>  | 4                | 3              | 0.007 kg |
|   | 2 NC        | A - B            | B = 42°         | Universal 2.0 x 0.5 mm | <b>52-432.036</b>  | 4                | 4              | 0.007 kg |
|   | 2 NO        | A - B            | B = 42°         | Universal 2.0 x 0.5 mm | <b>52-431.036</b>  | 4                | 5              | 0.007 kg |
|   | 1 NC        | A - C            | C = 90°         | Universal 2.0 x 0.5 mm | <b>52-476.036</b>  | 4                | 11             | 0.007 kg |
|   | 1 NC + 1 NO | A - C            | C = 90°         | Universal 2.0 x 0.5 mm | <b>52-473.036</b>  | 4                | 12             | 0.007 kg |
|   | 1 NO        | A - C            | C = 90°         | Universal 2.0 x 0.5 mm | <b>52-475.036</b>  | 4                | 13             | 0.007 kg |
|   | 2 NC        | A - C            | C = 90°         | Universal 2.0 x 0.5 mm | <b>52-472.036</b>  | 4                | 14             | 0.007 kg |
|   | 2 NO        | A - C            | C = 90°         | Universal 2.0 x 0.5 mm | <b>52-471.036</b>  | 4                | 15             | 0.007 kg |
| Snap-action switching element                                   | 1 NC + 1 NO | A - B            | B = 42°         | Solder                 | <b>52-131.0252</b> |                  | 6              | 0.006 kg |
|   |             |                  |                 | Solder 2.8 x 0.5 mm    | <b>52-131.022</b>  |                  | 7              | 0.006 kg |
|   | 2 NC + 2 NO | A - B            | B = 42°         | Solder                 | <b>52-132.0252</b> |                  | 8              | 0.006 kg |
|   | 3 NC + 3 NO | A - B            | B = 42°         | Solder                 | <b>52-133.0252</b> |                  | 9              | 0.006 kg |
|   | 4 NC + 4 NO | A - B            | B = 42°         | Solder                 | <b>52-134.0252</b> |                  | 10             | 0.006 kg |
|   | 1 NC + 1 NO | A - C            | C = 90°         | Solder                 | <b>52-271.0252</b> |                  | 16             | 0.006 kg |
|   |             |                  |                 | Solder 2.8 x 0.5 mm    | <b>52-271.022</b>  |                  | 17             | 0.006 kg |



| Switching system              | Contacts    | Switching action | Switching angle | Terminal | Part No.           | Component layout | Wiring diagram | Weight   |
|-------------------------------|-------------|------------------|-----------------|----------|--------------------|------------------|----------------|----------|
| Snap-action switching element | 2 NC + 2 NO | A - C            | C = 90°         | Solder   | <b>52-272.0252</b> |                  | 18             | 0.006 kg |
|                               | 3 NC + 3 NO | A - C            | C = 90°         | Solder   | <b>52-273.0252</b> |                  | 19             | 0.006 kg |
|                               | 4 NC + 4 NO | A - C            | C = 90°         | Solder   | <b>52-274.0252</b> |                  | 20             | 0.006 kg |

Contacts: NC = Normally closed, NO = Normally open  
 Switching action: A = Rest, B = Momentary, C = Maintain  
 The component layouts you will find from page 76



# 51 Flush design



## Selector switch 3 positions square, IP 40

### Equipment consisting of (schematic overview)



Each Part Number listed below includes all the black components shown in the 3D-drawing.

To obtain a complete unit, please select the red components from the pages shown.



Dimensions [mm]



Mounting cut-outs [mm]



Product can differ from the current configuration.

### Additional Information

- For front dimension 24 x 24 mm
- Illuminative



Switching positions (A = Rest, B = Momentary, C = Maintained)

| Switching system   | Contacts    | Switching action | Switching angle  | Terminal            | Part No.           | Wiring diagram | Weight   |
|--|-------------|------------------|------------------|---------------------|--------------------|----------------|----------|
| <br><b>Selector switch actuator 3 positions square, flush design</b> | 2 NC + 2 NO | B - A - B        | B = 42° / 42°    | Solder 2.8 x 0.5 mm | <b>52-572.022A</b> | 1              | 0.015 kg |
|  |             | C - A - B        | C = 90°, B = 42° | Solder 2.8 x 0.5 mm | <b>52-574.022A</b> | 2              | 0.015 kg |
|  |             | B - A - C        | B = 42°, C = 90° | Solder 2.8 x 0.5 mm | <b>52-573.022A</b> | 3              | 0.015 kg |
|  |             | C - A - C        | C = 90° / 90°    | Solder 2.8 x 0.5 mm | <b>52-571.022A</b> | 4              | 0.015 kg |

Contacts: NC = Normally closed, NO = Normally open  
 Switching action: A = Rest, B = Momentary, C = Maintain



## Selector switch 3 positions round, IP 40

### Equipment consisting of (schematic overview)



Dimensions [mm]



Product can differ from the current configuration.



Mounting cut-outs [mm]

### Additional Information

- For front dimension  $\varnothing 25$  mm
- Illuminative

Each Part Number listed below includes all the black components shown in the 3D-drawing.

To obtain a complete unit, please select the red components from the pages shown.



Switching positions (A = Rest, B = Momentary, C = Maintained)

| Switching system   | Contacts    | Switching action | Switching angle  | Terminal            | Part No.           | Wiring diagram | Weight   |
|--|-------------|------------------|------------------|---------------------|--------------------|----------------|----------|
| <br><b>Selector switch actuator 3 positions round, flush design</b> | 2 NC + 2 NO | B - A - B        | B = 42° / 42°    | Solder 2.8 x 0.5 mm | <b>52-572.022A</b> | 1              | 0.015 kg |
|  |             | C - A - B        | C = 90°, B = 42° | Solder 2.8 x 0.5 mm | <b>52-574.022A</b> | 2              | 0.015 kg |
|  |             | B - A - C        | B = 42°, C = 90° | Solder 2.8 x 0.5 mm | <b>52-573.022A</b> | 3              | 0.015 kg |
|  |             | C - A - C        | C = 90° / 90°    | Solder 2.8 x 0.5 mm | <b>52-571.022A</b> | 4              | 0.015 kg |

Contacts: NC = Normally closed, NO = Normally open  
Switching action: A = Rest, B = Momentary, C = Maintain



Indicator, IP 65

Equipment consisting of (schematic overview)



**Lens** page 53



**Single-LED** page 71



**Actuator**



**Fixing nut**



Dimensions [mm]  
 H = Universal terminal 2.0 x 0.5 mm,  
 L = Solder terminal,  
 L1 = Solder terminal 2.8 x 0.5 mm



Product can differ from the current configuration.

Each Part Number listed below includes all the black components shown in the 3D-drawing.

To obtain a complete unit, please select the red components from the pages shown.



Mounting cut-outs [mm]

|   |  | Terminal  | Part No.          | Component layout | Wiring diagram | Weight   |
|---|--|---|-------------------|------------------|----------------|----------|
|  |  | <b>Indicator actuator, Front dimension 18 x 18 mm</b> |                   |                  |                |          |
| 1   |  | Universal 2.0 x 0.5 mm                                | <b>51-703.006</b> | 4                | 3              | 0.006 kg |
| 2   |  | Universal 2.0 x 0.5 mm                                | <b>51-704.006</b> | 4                | 2              | 0.006 kg |
|   |  | Solder 2.8 x 0.5 mm                                   | <b>51-050.002</b> |                  | 1              | 0.004 kg |
|   |  | Solder  | <b>51-050.005</b> |                  | 1              | 0.004 kg |
|   |  | Universal 2.0 x 0.5 mm                                | <b>51-051.006</b> | 4                | 1              | 0.005 kg |
|  |  | <b>Indicator actuator, Front dimension 18 x 24 mm</b> |                   |                  |                |          |
| 1   |  | Universal 2.0 x 0.5 mm                                | <b>51-701.006</b> | 4                | 3              | 0.006 kg |
| 2   |  | Universal 2.0 x 0.5 mm                                | <b>51-702.006</b> | 4                | 2              | 0.006 kg |
|   |  | Solder 2.8 x 0.5 mm                                   | <b>51-040.002</b> |                  | 1              | 0.004 kg |
|   |  | Solder  | <b>51-040.005</b> |                  | 1              | 0.004 kg |
|   |  | Universal 2.0 x 0.5 mm                                | <b>51-041.006</b> | 4                | 1              | 0.005 kg |

# 51 Raised design

| Diode 1N4007   | Terminal               | Part No.          | Component layout | Wiring diagram | Weight   |
|--|------------------------|-------------------|------------------|----------------|----------|
|  <p><b>Indicator actuator, Front dimension Ø 18 mm</b></p> |                        |                   |                  |                |          |
| 1  | Universal 2.0 x 0.5 mm | <b>51-741.006</b> | 4                | 3              | 0.006 kg |
| 2  | Universal 2.0 x 0.5 mm | <b>51-742.006</b> | 4                | 2              | 0.006 kg |
|  | Solder 2.8 x 0.5 mm    | <b>51-030.002</b> |                  | 1              | 0.004 kg |
|  | Solder                 | <b>51-030.005</b> |                  | 1              | 0.004 kg |
|  | Universal 2.0 x 0.5 mm | <b>51-031.006</b> | 4                | 1              | 0.005 kg |

The component layouts you will find from page 76





**Illuminated pushbutton, IP 65**



Dimensions [mm]  
 H = Universal terminal 2.0 x 0.5 mm,  
 H1 = Universal-Solder terminal,  
 L = Solder terminal,  
 L1 = Solder terminal 2.8 x 0.5 mm

Product can differ from the current configuration.

Each Part Number listed below includes all the black components shown in the 3D-drawing.

To obtain a complete unit, please select the red components from the pages shown.



Mounting cut-outs [mm]

| Switching system  | Contacts    | Diode 1N4007       | Switching action              | Terminal               | Part No.           | Component layout | Wiring diagram   | Weight             |                    |          |          |
|---|-------------|--------------------|-------------------------------|------------------------|--------------------|------------------|------------------|--------------------|--------------------|----------|----------|
|  <p><b>Illuminated pushbutton actuator, Front dimension 18 x 18 mm</b></p> |             |                    |                               |                        |                    |                  |                  |                    |                    |          |          |
| Low-level element   | 1 NC        |                    | C                             | Universal 2.0 x 0.5 mm | <b>51-486.036</b>  | 4                | 2                | 0.007 kg           |                    |          |          |
|   | 1 NC + 1 NO |                    | B                             | Universal 2.0 x 0.5 mm | <b>51-453.036</b>  | 4                | 3                | 0.007 kg           |                    |          |          |
|   |             |                    | C                             | Universal 2.0 x 0.5 mm | <b>51-483.036</b>  | 4                | 4                | 0.007 kg           |                    |          |          |
|   | 1 NO        |                    | B                             | Universal 2.0 x 0.5 mm | <b>51-455.036</b>  | 4                | 5                | 0.007 kg           |                    |          |          |
|   |             |                    | C                             | Universal 2.0 x 0.5 mm | <b>51-485.036</b>  | 4                | 6                | 0.007 kg           |                    |          |          |
|   | 2 NC        |                    | B                             | Universal 2.0 x 0.5 mm | <b>51-452.036</b>  | 4                | 7                | 0.007 kg           |                    |          |          |
| 2 NO  |             |                    | B                             | Universal 2.0 x 0.5 mm | <b>51-451.036</b>  | 4                | 9                | 0.007 kg           |                    |          |          |
|   |             |                    | C                             | Universal 2.0 x 0.5 mm | <b>51-481.036</b>  | 4                | 10               | 0.007 kg           |                    |          |          |
|   |             |                    | Snap-action switching element | 1 NC + 1 NO            | 2                  | C                | Universal-Solder | <b>51-718.0292</b> | 13                 | 0.008 kg |          |
|   |             |                    |                               |                        |                    | B                | Universal-Solder | <b>51-710.0292</b> | 14                 | 0.008 kg |          |
|   |             |                    | B                             | Solder                 | <b>51-151.0252</b> | 15               | 0.006 kg         |                    |                    |          |          |
|   |             |                    | B                             | Solder 2.8 x 0.5 mm    | <b>51-151.022</b>  | 16               | 0.006 kg         |                    |                    |          |          |
|   |             |                    | C                             | Solder                 | <b>51-281.0252</b> | 17               | 0.006 kg         |                    |                    |          |          |
|   |             |                    | C                             | Solder 2.8 x 0.5 mm    | <b>51-281.022</b>  | 18               | 0.006 kg         |                    |                    |          |          |
|   |             |                    |                               | 2 NC + 2 NO            | 1                  | C                | Universal-Solder | <b>51-719.0292</b> | 20                 | 0.010 kg |          |
|   |             |                    |                               |                        |                    | 2                | B                | Universal-Solder   | <b>51-712.0292</b> | 21       | 0.010 kg |
|   |             |                    |                               |                        |                    |                  | C                | Universal-Solder   | <b>51-720.0292</b> | 22       | 0.010 kg |
|   |             |                    |                               |                        |                    | B                | Solder           | <b>51-152.0252</b> | 23                 | 0.008 kg |          |
| C   | Solder      | <b>51-282.0252</b> | 24                            | 0.008 kg               |                    |                  |                  |                    |                    |          |          |

# 51 Raised design

| Switching system              | Contacts    | Diode 1N4007 | Switching action | Terminal | Part No.           | Component layout | Wiring diagram | Weight   |
|-------------------------------|-------------|--------------|------------------|----------|--------------------|------------------|----------------|----------|
| Snap-action switching element | 3 NC + 3 NO |              | B                | Solder   | <b>51-153.0252</b> |                  | 25             | 0.010 kg |
|                               |             |              | C                | Solder   | <b>51-283.0252</b> |                  | 26             | 0.010 kg |
|                               | 4 NC + 4 NO |              | B                | Solder   | <b>51-154.0252</b> |                  | 27             | 0.012 kg |
|                               |             |              | C                | Solder   | <b>51-284.0252</b> |                  | 28             | 0.012 kg |



## Illuminated pushbutton actuator, Front dimension 18 x 24 mm

|                               |             |   |   |                        |                    |   |    |          |
|-------------------------------|-------------|---|---|------------------------|--------------------|---|----|----------|
| Low-level element             | 1 NC        |   | B | Universal 2.0 x 0.5 mm | <b>51-426.036</b>  | 4 | 1  | 0.007 kg |
|                               | 1 NC + 1 NO |   | B | Universal 2.0 x 0.5 mm | <b>51-423.036</b>  | 4 | 3  | 0.007 kg |
|                               |             |   | C | Universal 2.0 x 0.5 mm | <b>51-463.036</b>  | 4 | 4  | 0.007 kg |
|                               | 1 NO        |   | B | Universal 2.0 x 0.5 mm | <b>51-425.036</b>  | 4 | 5  | 0.007 kg |
|                               |             |   | C | Universal 2.0 x 0.5 mm | <b>51-465.036</b>  | 4 | 6  | 0.007 kg |
|                               | 2 NC        |   | B | Universal 2.0 x 0.5 mm | <b>51-422.036</b>  | 4 | 7  | 0.007 kg |
|                               | 2 NO        |   | B | Universal 2.0 x 0.5 mm | <b>51-421.036</b>  | 4 | 9  | 0.007 kg |
|                               |             |   | C | Universal 2.0 x 0.5 mm | <b>51-461.036</b>  | 4 | 10 | 0.007 kg |
| Snap-action switching element | 1 NC + 1 NO | 1 | B | Universal-Solder       | <b>51-705.0292</b> |   | 11 | 0.008 kg |
|                               |             |   | C | Universal-Solder       | <b>51-714.0292</b> |   | 13 | 0.008 kg |
|                               |             |   | B | Universal-Solder       | <b>51-706.0292</b> |   | 14 | 0.008 kg |
|                               |             |   | B | Solder                 | <b>51-121.0252</b> |   | 15 | 0.006 kg |
|                               |             |   | B | Solder 2.8 x 0.5 mm    | <b>51-121.022</b>  |   | 16 | 0.006 kg |
|                               |             |   | C | Solder                 | <b>51-261.0252</b> |   | 17 | 0.006 kg |
|                               | 2 NC + 2 NO | 1 | B | Universal-Solder       | <b>51-707.0292</b> |   | 19 | 0.010 kg |
|                               |             |   | C | Universal-Solder       | <b>51-715.0292</b> |   | 20 | 0.010 kg |
|                               |             | 2 | B | Universal-Solder       | <b>51-708.0292</b> |   | 21 | 0.010 kg |
|                               |             |   | C | Universal-Solder       | <b>51-716.0292</b> |   | 22 | 0.010 kg |
|                               |             |   | B | Solder                 | <b>51-122.0252</b> |   | 23 | 0.008 kg |
|                               |             |   | C | Solder                 | <b>51-262.0252</b> |   | 24 | 0.008 kg |
|                               | 3 NC + 3 NO |   | B | Solder                 | <b>51-123.0252</b> |   | 25 | 0.010 kg |
|                               |             |   | C | Solder                 | <b>51-263.0252</b> |   | 26 | 0.010 kg |
|                               | 4 NC + 4 NO |   | B | Solder                 | <b>51-124.0252</b> |   | 27 | 0.012 kg |
|                               |             |   | C | Solder                 | <b>51-264.0252</b> |   | 28 | 0.012 kg |



## Illuminated pushbutton actuator, Front dimension Ø 18 mm

|                   |                               |                  |             |                        |                    |                    |                    |          |
|-------------------|-------------------------------|------------------|-------------|------------------------|--------------------|--------------------|--------------------|----------|
| Low-level element | 1 NC                          |                  | B           | Universal 2.0 x 0.5 mm | <b>51-436.036</b>  | 4                  | 1                  | 0.007 kg |
|                   | 1 NC + 1 NO                   |                  | B           | Universal 2.0 x 0.5 mm | <b>51-433.036</b>  | 4                  | 3                  | 0.007 kg |
|                   |                               |                  | C           | Universal 2.0 x 0.5 mm | <b>51-473.036</b>  | 4                  | 4                  | 0.007 kg |
|                   | 1 NO                          |                  | B           | Universal 2.0 x 0.5 mm | <b>51-435.036</b>  | 4                  | 5                  | 0.007 kg |
|                   |                               |                  | C           | Universal 2.0 x 0.5 mm | <b>51-475.036</b>  | 4                  | 6                  | 0.007 kg |
|                   | 2 NO                          |                  | B           | Universal 2.0 x 0.5 mm | <b>51-431.036</b>  | 4                  | 9                  | 0.007 kg |
|                   |                               |                  | C           | Universal 2.0 x 0.5 mm | <b>51-471.036</b>  | 4                  | 10                 | 0.007 kg |
|                   | Snap-action switching element | 1 NC + 1 NO      | 1           | C                      | Universal-Solder   | <b>51-747.0292</b> |                    | 12       |
| B                 |                               |                  |             | Solder                 | <b>51-131.0252</b> |                    | 15                 | 0.006 kg |
|                   |                               |                  | B           | Solder 2.8 x 0.5 mm    | <b>51-131.022</b>  |                    | 16                 | 0.006 kg |
|                   |                               |                  | C           | Solder                 | <b>51-271.0252</b> |                    | 17                 | 0.006 kg |
|                   |                               |                  | C           | Solder 2.8 x 0.5 mm    | <b>51-271.022</b>  |                    | 18                 | 0.006 kg |
|                   |                               |                  | 2 NC + 2 NO | 1                      | C                  | Universal-Solder   | <b>51-749.0292</b> |          |
| B                 |                               | Universal-Solder |             |                        | <b>51-746.0292</b> |                    | 21                 | 0.010 kg |
| 2                 |                               | C                |             | Universal-Solder       | <b>51-750.0292</b> |                    | 22                 | 0.010 kg |

| Switching system              | Contacts    | Diode 1N4007 | Switching action | Terminal | Part No.           | Component layout | Wiring diagram | Weight   |
|-------------------------------|-------------|--------------|------------------|----------|--------------------|------------------|----------------|----------|
| Snap-action switching element | 2 NC + 2 NO |              | B                | Solder   | <b>51-132.0252</b> |                  | 23             | 0.008 kg |
|                               |             |              | C                | Solder   | <b>51-272.0252</b> |                  | 24             | 0.008 kg |
|                               | 3 NC + 3 NO |              | B                | Solder   | <b>51-133.0252</b> |                  | 25             | 0.010 kg |
|                               |             |              | C                | Solder   | <b>51-273.0252</b> |                  | 26             | 0.010 kg |
|                               | 4 NC + 4 NO |              | B                | Solder   | <b>51-134.0252</b> |                  | 27             | 0.012 kg |
|                               |             |              | C                | Solder   | <b>51-274.0252</b> |                  | 28             | 0.012 kg |

Contacts: NC = Normally closed, NO = Normally open  
 Switching action: B = Momentary, C = Maintain  
 The component layouts you will find from page 76



# 51 Raised design

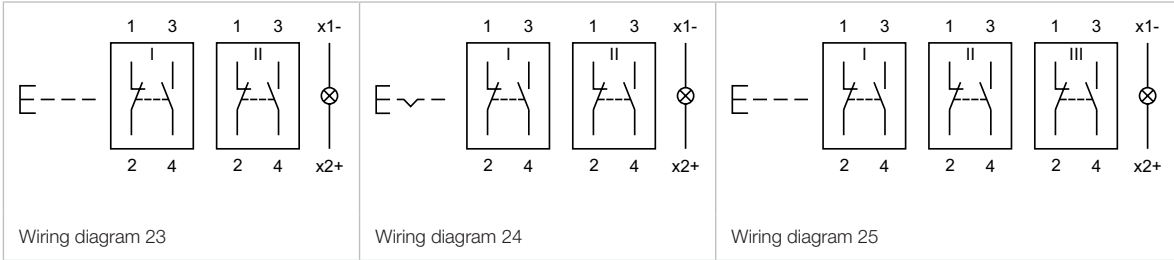

## Stop switch complete, IP 65

### Equipment consisting of (schematic overview)



Each Part Number listed below includes all the black components shown in the 3D-drawing.

Dimensions [mm]  
 H = Universal terminal 2.0 x 0.5 mm,  
 L = Solder terminal,  
 L1 = Solder terminal 2.8 x 0.5 mm

Product can differ from the current configuration.



Mounting cut-outs [mm]

### Additional Information

- Marking arrows
- If the anti-twist ring is not used the panel thickness increases to 4 mm

| Lens  | Switching system              | Contacts    | Switching action | Terminal               | Part No.           | Wiring diagram | Weight   |
|---|-------------------------------|-------------|------------------|------------------------|--------------------|----------------|----------|
| <br><b>Stop switch complete round, 24.5 mm</b> | Low-level element             | 1 NC        | C                | Universal 2.0 x 0.5 mm | <b>51-256.026</b>  | 3              | 0.010 kg |
|   |                               | 1 NC + 1 NO | C                | Universal 2.0 x 0.5 mm | <b>51-253.026</b>  | 5              | 0.011 kg |
|   |                               | 2 NC        | C                | Universal 2.0 x 0.5 mm | <b>51-252.026</b>  | 4              | 0.011 kg |
|   | Snap-action switching element | 1 NC + 1 NO | C                | Solder 2.8 x 0.5 mm    | <b>51-253.022</b>  | 1              | 0.011 kg |
|   |                               | 1 NC + 1 NO | C                | Solder                 | <b>51-256.025</b>  | 1              | 0.011 kg |
|   |                               | 2 NC + 2 NO | C                | Solder                 | <b>51-259.025</b>  | 2              | 0.011 kg |
| Plastic yellow  | Low-level element             | 1 NC        | C                | Universal 2.0 x 0.5 mm | <b>51-256.0264</b> | 3              | 0.010 kg |
|   |                               | 1 NC + 1 NO | C                | Universal 2.0 x 0.5 mm | <b>51-253.0264</b> | 5              | 0.011 kg |
|   |                               | 2 NC        | C                | Universal 2.0 x 0.5 mm | <b>51-252.0264</b> | 4              | 0.011 kg |
|   | Snap-action switching element | 1 NC + 1 NO | C                | Solder 2.8 x 0.5 mm    | <b>51-253.0224</b> | 1              | 0.011 kg |
|   |                               | 1 NC + 1 NO | C                | Solder                 | <b>51-256.0254</b> | 1              | 0.011 kg |
|   |                               | 2 NC + 2 NO | C                | Solder                 | <b>51-259.0254</b> | 2              | 0.011 kg |
| Plastic green   | Low-level element             | 1 NC        | C                | Universal 2.0 x 0.5 mm | <b>51-256.0265</b> | 3              | 0.010 kg |
|   |                               | 1 NC + 1 NO | C                | Universal 2.0 x 0.5 mm | <b>51-253.0265</b> | 5              | 0.011 kg |
|   |                               | 2 NC        | C                | Universal 2.0 x 0.5 mm | <b>51-252.0265</b> | 4              | 0.011 kg |
|   | Snap-action switching element | 1 NC + 1 NO | C                | Solder 2.8 x 0.5 mm    | <b>51-253.0225</b> | 1              | 0.011 kg |
|   |                               | 1 NC + 1 NO | C                | Solder                 | <b>51-256.0255</b> | 1              | 0.011 kg |
|   |                               | 2 NC + 2 NO | C                | Solder                 | <b>51-259.0255</b> | 2              | 0.011 kg |

# 51 Raised design

| Lens          | Switching system              | Contacts    | Switching action | Terminal               | Part No.           | Wiring diagram | Weight   |
|---------------|-------------------------------|-------------|------------------|------------------------|--------------------|----------------|----------|
| Plastic blue  | Low-level element             | 1 NC        | C                | Universal 2.0 x 0.5 mm | <b>51-256.0266</b> | 3              | 0.010 kg |
|               |                               | 1 NC + 1 NO | C                | Universal 2.0 x 0.5 mm | <b>51-253.0266</b> | 5              | 0.011 kg |
|               |                               | 2 NC        | C                | Universal 2.0 x 0.5 mm | <b>51-252.0266</b> | 4              | 0.011 kg |
|               | Snap-action switching element | 1 NC + 1 NO | C                | Solder 2.8 x 0.5 mm    | <b>51-253.0226</b> | 1              | 0.011 kg |
|               |                               | 1 NC + 1 NO | C                | Solder                 | <b>51-256.0256</b> | 1              | 0.011 kg |
|               |                               | 2 NC + 2 NO | C                | Solder                 | <b>51-259.0256</b> | 2              | 0.011 kg |
| Plastic grey  | Low-level element             | 1 NC        | C                | Universal 2.0 x 0.5 mm | <b>51-256.0268</b> | 3              | 0.010 kg |
|               |                               | 1 NC + 1 NO | C                | Universal 2.0 x 0.5 mm | <b>51-253.0268</b> | 5              | 0.011 kg |
|               |                               | 2 NC        | C                | Universal 2.0 x 0.5 mm | <b>51-252.0268</b> | 4              | 0.011 kg |
|               | Snap-action switching element | 1 NC + 1 NO | C                | Solder 2.8 x 0.5 mm    | <b>51-253.0228</b> | 1              | 0.011 kg |
|               |                               | 1 NC + 1 NO | C                | Solder                 | <b>51-256.0258</b> | 1              | 0.011 kg |
|               |                               | 2 NC + 2 NO | C                | Solder                 | <b>51-259.0258</b> | 2              | 0.011 kg |
| Plastic black | Low-level element             | 1 NC        | C                | Universal 2.0 x 0.5 mm | <b>51-256.0260</b> | 3              | 0.010 kg |
|               |                               | 1 NC + 1 NO | C                | Universal 2.0 x 0.5 mm | <b>51-253.0260</b> | 5              | 0.011 kg |
|               |                               | 2 NC        | C                | Universal 2.0 x 0.5 mm | <b>51-252.0260</b> | 4              | 0.011 kg |
|               | Snap-action switching element | 1 NC + 1 NO | C                | Solder 2.8 x 0.5 mm    | <b>51-253.0220</b> | 1              | 0.011 kg |
|               |                               | 1 NC + 1 NO | C                | Solder                 | <b>51-256.0250</b> | 1              | 0.011 kg |
|               |                               | 2 NC + 2 NO | C                | Solder                 | <b>51-259.0250</b> | 2              | 0.011 kg |

Contacts: NC = Normally closed, NO = Normally open  
Switching action: C = Maintained



## Mushroom-head complete, IP 65

### Equipment consisting of (schematic overview)



Each Part Number listed below includes all the black components shown in the 3D-drawing.

To obtain a complete unit, please select the red components from the pages shown.



Dimensions [mm]  
 H = Universal terminal 2.0 x 0.5 mm,  
 L = Solder terminal,  
 L1 = Solder terminal 2.8 x 0.5 mm



Product can differ from the current configuration.



Mounting cut-outs [mm]

### Additional Information

- If the anti-twist ring is not used the panel thickness increases to 4 mm

| Lens  | Switching system              | Contacts    | Switching action | Terminal               | Part No.           | Wiring diagram | Weight   |
|---|-------------------------------|-------------|------------------|------------------------|--------------------|----------------|----------|
| <br><b>Mushroom-head complete round, 24.5 mm</b> | Low-level element             | 1 NC        | C                | Universal 2.0 x 0.5 mm | <b>51-156.0262</b> | 3              | 0.010 kg |
|   |                               | 1 NC + 1 NO | C                | Universal 2.0 x 0.5 mm | <b>51-153.0262</b> | 5              | 0.011 kg |
|   |                               | 2 NC        | C                | Universal 2.0 x 0.5 mm | <b>51-152.0262</b> | 4              | 0.011 kg |
|   | Snap-action switching element | 1 NC + 1 NO | C                | Solder 2.8 x 0.5 mm    | <b>51-153.0222</b> | 1              | 0.011 kg |
|   |                               | 1 NC + 1 NO | B                | Solder                 | <b>51-156.0252</b> | 1              | 0.011 kg |
|   |                               | 2 NC + 2 NO | C                | Solder                 | <b>51-159.0252</b> | 2              | 0.011 kg |
| Plastic yellow  | Low-level element             | 1 NC        | C                | Universal 2.0 x 0.5 mm | <b>51-156.0264</b> | 3              | 0.010 kg |
|   |                               | 1 NC + 1 NO | C                | Universal 2.0 x 0.5 mm | <b>51-153.0264</b> | 5              | 0.011 kg |
|   |                               | 2 NC        | C                | Universal 2.0 x 0.5 mm | <b>51-152.0264</b> | 4              | 0.011 kg |
|   | Snap-action switching element | 1 NC + 1 NO | C                | Solder 2.8 x 0.5 mm    | <b>51-153.0224</b> | 1              | 0.011 kg |
|   |                               | 1 NC + 1 NO | B                | Solder                 | <b>51-156.0254</b> | 1              | 0.011 kg |
|   |                               | 2 NC + 2 NO | C                | Solder                 | <b>51-159.0254</b> | 2              | 0.011 kg |
| Plastic green   | Low-level element             | 1 NC        | C                | Universal 2.0 x 0.5 mm | <b>51-156.0265</b> | 3              | 0.010 kg |
|   |                               | 1 NC + 1 NO | C                | Universal 2.0 x 0.5 mm | <b>51-153.0265</b> | 5              | 0.011 kg |
|   |                               | 2 NC        | C                | Universal 2.0 x 0.5 mm | <b>51-152.0265</b> | 4              | 0.011 kg |
|   | Snap-action switching element | 1 NC + 1 NO | C                | Solder 2.8 x 0.5 mm    | <b>51-153.0225</b> | 1              | 0.011 kg |
|   |                               | 1 NC + 1 NO | B                | Solder                 | <b>51-156.0255</b> | 1              | 0.011 kg |
|   |                               | 2 NC + 2 NO | C                | Solder                 | <b>51-159.0255</b> | 2              | 0.011 kg |

# 51 Raised design

| Lens          | Switching system              | Contacts    | Switching action | Terminal               | Part No.           | Wiring diagram | Weight   |
|---------------|-------------------------------|-------------|------------------|------------------------|--------------------|----------------|----------|
| Plastic blue  | Low-level element             | 1 NC        | C                | Universal 2.0 x 0.5 mm | <b>51-156.0266</b> | 3              | 0.010 kg |
|               | Low-level element             | 1 NC + 1 NO | C                | Universal 2.0 x 0.5 mm | <b>51-153.0266</b> | 5              | 0.011 kg |
|               | Low-level element             | 2 NC        | C                | Universal 2.0 x 0.5 mm | <b>51-152.0266</b> | 4              | 0.011 kg |
|               | Snap-action switching element | 1 NC + 1 NO | C                | Solder 2.8 x 0.5 mm    | <b>51-153.0226</b> | 1              | 0.011 kg |
|               | Snap-action switching element | 1 NC + 1 NO | B                | Solder                 | <b>51-156.0256</b> | 1              | 0.011 kg |
|               | Snap-action switching element | 2 NC + 2 NO | C                | Solder                 | <b>51-159.0256</b> | 2              | 0.011 kg |
| Plastic grey  | Low-level element             | 1 NC        | C                | Universal 2.0 x 0.5 mm | <b>51-156.0268</b> | 3              | 0.010 kg |
|               | Low-level element             | 1 NC + 1 NO | C                | Universal 2.0 x 0.5 mm | <b>51-153.0268</b> | 5              | 0.011 kg |
|               | Low-level element             | 2 NC        | C                | Universal 2.0 x 0.5 mm | <b>51-152.0268</b> | 4              | 0.011 kg |
|               | Snap-action switching element | 1 NC + 1 NO | C                | Solder 2.8 x 0.5 mm    | <b>51-153.0228</b> | 1              | 0.011 kg |
|               | Snap-action switching element | 1 NC + 1 NO | B                | Solder                 | <b>51-156.0258</b> | 1              | 0.011 kg |
|               | Snap-action switching element | 2 NC + 2 NO | C                | Solder                 | <b>51-159.0258</b> | 2              | 0.011 kg |
| Plastic black | Low-level element             | 1 NC        | C                | Universal 2.0 x 0.5 mm | <b>51-156.0260</b> | 3              | 0.010 kg |
|               | Low-level element             | 1 NC + 1 NO | C                | Universal 2.0 x 0.5 mm | <b>51-153.0260</b> | 5              | 0.011 kg |
|               | Low-level element             | 2 NC        | C                | Universal 2.0 x 0.5 mm | <b>51-152.0260</b> | 4              | 0.011 kg |
|               | Snap-action switching element | 1 NC + 1 NO | C                | Solder 2.8 x 0.5 mm    | <b>51-153.0220</b> | 1              | 0.011 kg |
|               | Snap-action switching element | 1 NC + 1 NO | B                | Solder                 | <b>51-156.0250</b> | 1              | 0.011 kg |
|               | Snap-action switching element | 2 NC + 2 NO | C                | Solder                 | <b>51-159.0250</b> | 2              | 0.011 kg |

Contacts: NC = Normally closed, NO = Normally open  
 Switching action: B = Momentary  
 Switching action: B = Momentary, C = Maintained

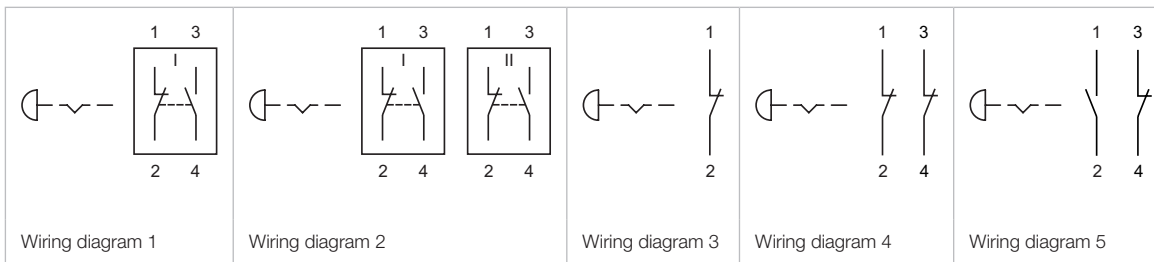



## Keylock switch 2 positions, IP 65

### Equipment consisting of (schematic overview)



Actuator



Anti-twist ring



Fixing nut



Dimensions [mm]  
 H = Universal terminal 2.0 x 0.5 mm,  
 L = Solder terminal,  
 L1 = Solder terminal 2.8 x 0.5 mm



Product can differ from the current configuration.

Each Part Number listed below includes all the black components shown in the 3D-drawing.



Mounting cut-outs [mm]

### Additional Information

- Front plastic black
- The standard lock: DOM 311
- Two keys are supplied with each key lock switch
- Optional lock numbers on request



Switching positions (A = Rest, B = Momentary, C = Maintained)

| Switching system  | Contacts                      | Switching action | Switching angle | Key remove          | Terminal               | Part No.            | Component layout   | Wiring diagram | Weight   |
|---|-------------------------------|------------------|-----------------|---------------------|------------------------|---------------------|--------------------|----------------|----------|
|  <b>Keylock switch 2 positions, Front dimension 18 x 18 mm</b> |                               |                  |                 |                     |                        |                     |                    |                |          |
| Low-level element   | 1 NC + 1 NO                   | A - B            | B = 42°         | A                   | Universal 2.0 x 0.5 mm | <b>51-458.036D</b>  | 4                  | 1              | 0.017 kg |
|   | 2 NO                          | A - B            | B = 42°         | A                   | Universal 2.0 x 0.5 mm | <b>51-457.036D</b>  | 4                  | 2              | 0.017 kg |
|   | 1 NC + 1 NO                   | A - C            | C = 90°         | A                   | Universal 2.0 x 0.5 mm | <b>51-445.036D</b>  | 4                  | 7              | 0.017 kg |
|   |                               |                  |                 | C                   | Universal 2.0 x 0.5 mm | <b>51-448.036D</b>  | 4                  | 7              | 0.017 kg |
|   |                               |                  |                 | A + C               | Universal 2.0 x 0.5 mm | <b>51-442.036D</b>  | 4                  | 7              | 0.017 kg |
|   | 2 NO                          | A - C            | C = 90°         | A                   | Universal 2.0 x 0.5 mm | <b>51-444.036D</b>  | 4                  | 8              | 0.017 kg |
|   |                               |                  |                 | A + C               | Universal 2.0 x 0.5 mm | <b>51-441.036D</b>  | 4                  | 8              | 0.017 kg |
|   | Snap-action switching element | 1 NC + 1 NO      | A - B           | B = 42°             | A                      | Solder 2.8 x 0.5 mm | <b>51-145.022D</b> |                | 3        |
| A   |                               |                  |                 |                     | Solder                 | <b>51-145.025D2</b> |                    | 3              | 0.016 kg |
| 2 NC + 2 NO   |                               | A - B            | B = 42°         | A                   | Solder                 | <b>51-146.025D2</b> |                    | 4              | 0.016 kg |
| 4 NC + 4 NO   |                               | A - B            | B = 42°         | A                   | Solder                 | <b>51-148.025D2</b> |                    | 6              | 0.016 kg |
| 1 NC + 1 NO   |                               | A - C            | C = 90°         | A                   | Solder                 | <b>51-255.025D2</b> |                    | 9              | 0.016 kg |
|   |                               |                  |                 | C                   | Solder                 | <b>51-355.025D2</b> |                    | 9              | 0.016 kg |
|   |                               |                  |                 | A + C               | Solder                 | <b>51-155.025D2</b> |                    | 9              | 0.016 kg |
|   |                               |                  |                 | A                   | Solder 2.8 x 0.5 mm    | <b>51-255.022D</b>  |                    | 9              | 0.016 kg |
|   |                               |                  | C               | Solder 2.8 x 0.5 mm | <b>51-355.022D</b>     |                     | 9                  | 0.016 kg       |          |

# 51 Raised design

| Switching system              | Contacts    | Switching action | Switching angle | Key remove | Terminal            | Part No.            | Component layout | Wiring diagram | Weight   |
|-------------------------------|-------------|------------------|-----------------|------------|---------------------|---------------------|------------------|----------------|----------|
| Snap-action switching element | 1 NC + 1 NO | A - C            | C = 90°         | A + C      | Solder 2.8 x 0.5 mm | <b>51-155.022D</b>  |                  | 9              | 0.016 kg |
|                               |             |                  |                 | A          | Solder              | <b>51-256.025D2</b> |                  | 10             | 0.016 kg |
|                               | 2 NC + 2 NO | A - C            | C = 90°         | C          | Solder              | <b>51-356.025D2</b> |                  | 10             | 0.016 kg |
|                               |             |                  |                 | A + C      | Solder              | <b>51-156.025D2</b> |                  | 10             | 0.016 kg |
|                               |             |                  |                 | A          | Solder              | <b>51-257.025D2</b> |                  | 11             | 0.016 kg |
|                               | 3 NC + 3 NO | A - C            | C = 90°         | A + C      | Solder              | <b>51-157.025D2</b> |                  | 11             | 0.016 kg |
|                               |             |                  |                 | A          | Solder              | <b>51-258.025D2</b> |                  | 12             | 0.016 kg |
|                               |             |                  |                 | C          | Solder              | <b>51-358.025D2</b> |                  | 12             | 0.016 kg |
|                               | 4 NC + 4 NO | A - C            | C = 90°         | A + C      | Solder              | <b>51-158.025D2</b> |                  | 12             | 0.016 kg |



## Keylock switch 2 positions, Front dimension 18 x 24 mm

|                   |                               |             |         |         |                        |                     |                     |    |          |          |
|-------------------|-------------------------------|-------------|---------|---------|------------------------|---------------------|---------------------|----|----------|----------|
| Low-level element | 1 NC + 1 NO                   | A - B       | B = 42° | A       | Universal 2.0 x 0.5 mm | <b>51-428.036D</b>  | 4                   | 1  | 0.017 kg |          |
|                   |                               |             |         | A       | Universal 2.0 x 0.5 mm | <b>51-427.036D</b>  | 4                   | 2  | 0.017 kg |          |
|                   | 1 NC + 1 NO                   | A - C       | C = 90° | A       | Universal 2.0 x 0.5 mm | <b>51-405.036D</b>  | 4                   | 7  | 0.017 kg |          |
|                   |                               |             |         | C       | Universal 2.0 x 0.5 mm | <b>51-408.036D</b>  | 4                   | 7  | 0.017 kg |          |
|                   |                               |             |         | A + C   | Universal 2.0 x 0.5 mm | <b>51-402.036D</b>  | 4                   | 7  | 0.017 kg |          |
|                   | 2 NO                          | A - C       | C = 90° | A       | Universal 2.0 x 0.5 mm | <b>51-404.036D</b>  | 4                   | 8  | 0.017 kg |          |
|                   |                               |             |         | C       | Universal 2.0 x 0.5 mm | <b>51-407.036D</b>  | 4                   | 8  | 0.017 kg |          |
|                   |                               |             |         | A + C   | Universal 2.0 x 0.5 mm | <b>51-401.036D</b>  | 4                   | 8  | 0.017 kg |          |
|                   | Snap-action switching element | 1 NC + 1 NO | A - B   | B = 42° | A                      | Solder 2.8 x 0.5 mm | <b>51-495.022D</b>  |    | 3        | 0.016 kg |
|                   |                               |             |         |         | A                      | Solder              | <b>51-495.025D2</b> |    | 3        | 0.016 kg |
|                   |                               | 2 NC + 2 NO | A - B   | B = 42° | A                      | Solder              | <b>51-496.025D2</b> |    | 4        | 0.016 kg |
|                   |                               |             |         |         | A                      | Solder              | <b>51-497.025D2</b> |    | 5        | 0.016 kg |
| 3 NC + 3 NO       |                               | A - B       | B = 42° | A       | Solder                 | <b>51-498.025D2</b> |                     | 6  | 0.016 kg |          |
|                   |                               |             |         | A       | Solder                 | <b>51-295.025D2</b> |                     | 9  | 0.016 kg |          |
| 1 NC + 1 NO       |                               | A - C       | C = 90° | C       | Solder                 | <b>51-395.025D2</b> |                     | 9  | 0.016 kg |          |
|                   |                               |             |         | A + C   | Solder                 | <b>51-195.025D2</b> |                     | 9  | 0.016 kg |          |
|                   |                               |             |         | A       | Solder 2.8 x 0.5 mm    | <b>51-295.022D</b>  |                     | 9  | 0.016 kg |          |
|                   |                               |             |         | C       | Solder 2.8 x 0.5 mm    | <b>51-395.022D</b>  |                     | 9  | 0.016 kg |          |
|                   |                               |             |         | A + C   | Solder 2.8 x 0.5 mm    | <b>51-195.022D</b>  |                     | 9  | 0.016 kg |          |
| 2 NC + 2 NO       |                               | A - C       | C = 90° | A       | Solder                 | <b>51-296.025D2</b> |                     | 10 | 0.016 kg |          |
|                   |                               |             |         | C       | Solder                 | <b>51-396.025D2</b> |                     | 10 | 0.016 kg |          |
|                   |                               |             |         | A + C   | Solder                 | <b>51-196.025D2</b> |                     | 10 | 0.016 kg |          |
| 3 NC + 3 NO       |                               | A - C       | C = 90° | A       | Solder                 | <b>51-297.025D2</b> |                     | 11 | 0.016 kg |          |
|                   |                               |             |         | C       | Solder                 | <b>51-397.025D2</b> |                     | 11 | 0.016 kg |          |
|                   |                               |             |         | A + C   | Solder                 | <b>51-197.025D2</b> |                     | 11 | 0.016 kg |          |
| 4 NC + 4 NO       |                               | A - C       | C = 90° | A       | Solder                 | <b>51-298.025D2</b> |                     | 12 | 0.016 kg |          |
|                   |                               |             |         | A + C   | Solder                 | <b>51-198.025D2</b> |                     | 12 | 0.016 kg |          |

| Switching system  | Contacts    | Switching action    | Switching angle    | Key remove  | Terminal               | Part No.            | Component layout    | Wiring diagram     | Weight              |          |          |          |
|---|-------------|---------------------|--------------------|-------------|------------------------|---------------------|---------------------|--------------------|---------------------|----------|----------|----------|
|  <p><b>Keylock switch 2 positions, Front dimension Ø 18 mm</b></p> |             |                     |                    |             |                        |                     |                     |                    |                     |          |          |          |
| Low-level element   | 1 NC + 1 NO | A - B               | B = 42°            | A           | Universal 2.0 x 0.5 mm | <b>51-438.036D</b>  | 4                   | 1                  | 0.017 kg            |          |          |          |
|   |             | A - C               | C = 90°            | A           | Universal 2.0 x 0.5 mm | <b>51-415.036D</b>  | 4                   | 7                  | 0.017 kg            |          |          |          |
|   |             |                     |                    | C           | Universal 2.0 x 0.5 mm | <b>51-418.036D</b>  | 4                   | 7                  | 0.017 kg            |          |          |          |
|   |             |                     |                    | A + C       | Universal 2.0 x 0.5 mm | <b>51-412.036D</b>  | 4                   | 7                  | 0.017 kg            |          |          |          |
|   | 2 NO        | A - C               | C = 90°            | A           | Universal 2.0 x 0.5 mm | <b>51-414.036D</b>  | 4                   | 8                  | 0.017 kg            |          |          |          |
|   |             |                     |                    | A + C       | Universal 2.0 x 0.5 mm | <b>51-411.036D</b>  | 4                   | 8                  | 0.017 kg            |          |          |          |
| Snap-action switching element   | 1 NC + 1 NO | A - B               | B = 42°            | A           | Solder 2.8 x 0.5 mm    | <b>51-141.022D</b>  |                     | 3                  | 0.016 kg            |          |          |          |
|   |             |                     |                    | A           | Solder                 | <b>51-141.025D2</b> |                     | 3                  | 0.016 kg            |          |          |          |
|   | 2 NC + 2 NO | A - B               | B = 42°            | A           | Solder                 | <b>51-142.025D2</b> |                     | 4                  | 0.016 kg            |          |          |          |
|   |             |                     |                    | A           | Solder                 | <b>51-143.025D2</b> |                     | 5                  | 0.016 kg            |          |          |          |
|   | 3 NC + 3 NO | A - B               | B = 42°            | A           | Solder                 | <b>51-144.025D2</b> |                     | 6                  | 0.016 kg            |          |          |          |
|   | 4 NC + 4 NO | A - B               | B = 42°            | A           | Solder                 | <b>51-144.025D2</b> |                     | 6                  | 0.016 kg            |          |          |          |
|   |             |                     |                    | 1 NC + 1 NO | A - C                  | C = 90°             | A                   | Solder             | <b>51-235.025D2</b> |          | 9        | 0.016 kg |
|   |             |                     |                    |             |                        |                     | C                   | Solder             | <b>51-335.025D2</b> |          | 9        | 0.016 kg |
|   |             |                     |                    |             |                        |                     | A + C               | Solder             | <b>51-135.025D2</b> |          | 9        | 0.016 kg |
|   |             |                     |                    | A           | Solder 2.8 x 0.5 mm    | <b>51-235.022D</b>  |                     | 9                  | 0.016 kg            |          |          |          |
|   |             |                     |                    |             |                        | C                   | Solder 2.8 x 0.5 mm | <b>51-335.022D</b> |                     | 9        | 0.016 kg |          |
|   | A + C       | Solder 2.8 x 0.5 mm | <b>51-135.022D</b> |             |                        |                     |                     |                    | 9                   | 0.016 kg |          |          |
|   | 2 NC + 2 NO | A - C               | C = 90°            | A           | Solder                 | <b>51-236.025D2</b> |                     | 10                 | 0.016 kg            |          |          |          |
|   |             |                     |                    | C           | Solder                 | <b>51-336.025D2</b> |                     | 10                 | 0.016 kg            |          |          |          |
|   |             |                     |                    | A + C       | Solder                 | <b>51-136.025D2</b> |                     | 10                 | 0.016 kg            |          |          |          |
|   | 3 NC + 3 NO | A - C               | C = 90°            | A           | Solder                 | <b>51-237.025D2</b> |                     | 11                 | 0.016 kg            |          |          |          |
|   |             |                     |                    | A + C       | Solder                 | <b>51-137.025D2</b> |                     | 11                 | 0.016 kg            |          |          |          |
|   | 4 NC + 4 NO | A - C               | C = 90°            | A           | Solder                 | <b>51-238.025D2</b> |                     | 12                 | 0.016 kg            |          |          |          |
| C   |             |                     |                    | Solder      | <b>51-338.025D2</b>    |                     | 12                  | 0.016 kg           |                     |          |          |          |
| A + C   |             |                     |                    | Solder      | <b>51-138.025D2</b>    |                     | 12                  | 0.016 kg           |                     |          |          |          |

Contacts: NC = Normally closed, NO = Normally open  
 Switching action: A = Rest, B = Momentary, C = Maintain  
 The component layouts you will find from page 76

# 51 Raised design



**Keylock switch 3 positions, IP 65**

**Equipment consisting of (schematic overview)**



Each Part Number listed below includes all the black components shown in the 3D-drawing.



Dimensions [mm]



Product can differ from the current configuration.



Mounting cut-outs [mm]

**Additional Information**

- Front plastic black
- The standard lock: DOM 311
- Two keys are supplied with each key lock switch
- Optional lock numbers on request

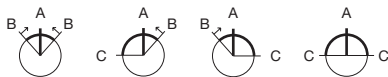

Switching positions (A = Rest, B = Momentary, C = Maintained)

| Switching system   | Contacts    | Switching action | Switching angle  | Key remove | Terminal            | Part No.           | Wiring diagram | Weight   |
|--|-------------|------------------|------------------|------------|---------------------|--------------------|----------------|----------|
|  <p><b>Keylock switch 3 positions, Front dimension 18 x 18 mm</b></p> |             |                  |                  |            |                     |                    |                |          |
| Snap-action switching element  | 2 NC + 2 NO | B - A - B        | B = 42° / 42°    | A          | Solder 2.8 x 0.5 mm | <b>51-384.022D</b> | 1              | 0.025 kg |
|  |             | C - A - B        | C = 90°, B = 42° | C + A      | Solder 2.8 x 0.5 mm | <b>51-388.022D</b> | 3              | 0.025 kg |
|  |             | B - A - C        | B = 42°, C = 90° | A          | Solder 2.8 x 0.5 mm | <b>51-385.022D</b> | 2              | 0.025 kg |
|  |             | C - A - C        | C = 90° / 90°    | A          | Solder 2.8 x 0.5 mm | <b>51-381.022D</b> | 4              | 0.025 kg |
|  |             |                  |                  | C + A + C  | Solder 2.8 x 0.5 mm | <b>51-382.022D</b> | 4              | 0.025 kg |
|  <p><b>Keylock switch 3 positions, Front dimension 18 x 24 mm</b></p> |             |                  |                  |            |                     |                    |                |          |
| Snap-action switching element  | 2 NC + 2 NO | B - A - B        | B = 42° / 42°    | A          | Solder 2.8 x 0.5 mm | <b>51-364.022D</b> | 1              | 0.025 kg |
|  |             | B - A - C        | B = 42°, C = 90° | A          | Solder 2.8 x 0.5 mm | <b>51-365.022D</b> | 2              | 0.025 kg |
|  |             |                  |                  | A + C      | Solder 2.8 x 0.5 mm | <b>51-366.022D</b> | 2              | 0.025 kg |
|  |             |                  |                  | A          | Solder 2.8 x 0.5 mm | <b>51-361.022D</b> | 4              | 0.025 kg |
|  |             | C - A - C        | C = 90° / 90°    | C + A + C  | Solder 2.8 x 0.5 mm | <b>51-362.022D</b> | 4              | 0.025 kg |
|  |             |                  |                  | C + C      | Solder 2.8 x 0.5 mm | <b>51-363.022D</b> | 4              | 0.025 kg |

# 51 Raised design

| Switching system   | Contacts    | Switching action | Switching angle  | Key remove | Terminal            | Part No.           | Wiring diagram | Weight   |
|--|-------------|------------------|------------------|------------|---------------------|--------------------|----------------|----------|
|  <p><b>Keylock switch 3 positions, Front dimension Ø 18 mm</b></p> |             |                  |                  |            |                     |                    |                |          |
| Snap-action switching element  | 2 NC + 2 NO | B - A - B        | B = 42° / 42°    | A          | Solder 2.8 x 0.5 mm | <b>51-374.022D</b> | 1              | 0.025 kg |
|  |             | C - A - B        | C = 90°, B = 42° | A          | Solder 2.8 x 0.5 mm | <b>51-377.022D</b> | 3              | 0.025 kg |
|  |             |                  |                  | C + A      | Solder 2.8 x 0.5 mm | <b>51-378.022D</b> | 3              | 0.025 kg |
|  |             | B - A - C        | B = 42°, C = 90° | A + C      | Solder 2.8 x 0.5 mm | <b>51-376.022D</b> | 2              | 0.025 kg |
|  |             | C - A - C        | C = 90° / 90°    | A          | Solder 2.8 x 0.5 mm | <b>51-371.022D</b> | 4              | 0.025 kg |
|  |             |                  |                  | C + A + C  | Solder 2.8 x 0.5 mm | <b>51-372.022D</b> | 4              | 0.025 kg |
|  |             |                  |                  | C + C      | Solder 2.8 x 0.5 mm | <b>51-373.022D</b> | 4              | 0.025 kg |

Contacts: NC = Normally closed, NO = Normally open  
 Switching action: A = Rest, B = Momentary, C = Maintain



## Selector switch 2 positions, IP 65

### Equipment consisting of (schematic overview)

-  **Lever** page 58
-  **Single-LED** page 71
-  **Actuator**
-  **Anti-twist ring**
-  **Fixing nut**

Each Part Number listed below includes all the black components shown in the 3D-drawing.

To obtain a complete unit, please select the red components from the pages shown.



Dimensions [mm]  
 H = Universal terminal 2.0 x 0.5 mm,  
 H1 = Universal-Solder terminal,  
 L = Solder terminal,  
 L1 = Solder terminal 2.8 x 0.5 mm



Product can differ from the current configuration.



Mounting cut-outs [mm]

### Additional Information

- Illuminative



Switching positions (A = Rest, B = Momentary, C = Maintained)

| Switching system   | Contacts    | Diode 1N4007 | Switching action | Switching angle | Terminal               | Part No.           | Component layout | Wiring diagram | Weight   |
|--|-------------|--------------|------------------|-----------------|------------------------|--------------------|------------------|----------------|----------|
| <br>Low-level element | 1 NC        |              | A - B            | B = 42°         | Universal 2.0 x 0.5 mm | <b>52-436.036</b>  | 4                | 1              | 0.007 kg |
|  | 1 NC + 1 NO |              | A - B            | B = 42°         | Universal 2.0 x 0.5 mm | <b>52-433.036</b>  | 4                | 2              | 0.007 kg |
|  | 1 NO        |              | A - B            | B = 42°         | Universal 2.0 x 0.5 mm | <b>52-435.036</b>  | 4                | 3              | 0.007 kg |
|  | 2 NC        |              | A - B            | B = 42°         | Universal 2.0 x 0.5 mm | <b>52-432.036</b>  | 4                | 4              | 0.007 kg |
|  | 2 NO        |              | A - B            | B = 42°         | Universal 2.0 x 0.5 mm | <b>52-431.036</b>  | 4                | 5              | 0.007 kg |
|  | 1 NC        |              | A - C            | C = 90°         | Universal 2.0 x 0.5 mm | <b>52-476.036</b>  | 4                | 15             | 0.007 kg |
|  | 1 NC + 1 NO |              | A - C            | C = 90°         | Universal 2.0 x 0.5 mm | <b>52-473.036</b>  | 4                | 16             | 0.007 kg |
|  | 1 NO        |              | A - C            | C = 90°         | Universal 2.0 x 0.5 mm | <b>52-475.036</b>  | 4                | 17             | 0.007 kg |
|  | 2 NC        |              | A - C            | C = 90°         | Universal 2.0 x 0.5 mm | <b>52-472.036</b>  | 4                | 18             | 0.007 kg |
|  | 2 NO        |              | A - C            | C = 90°         | Universal 2.0 x 0.5 mm | <b>52-471.036</b>  | 4                | 19             | 0.007 kg |
| Snap-action switching element  | 1 NC + 1 NO | 1            | A - B            | B = 42°         | Universal-Solder       | <b>52-743.0292</b> | 6                |                | 0.008 kg |
|  |             | 2            | A - B            | B = 42°         | Universal-Solder       | <b>52-744.0292</b> | 7                |                | 0.008 kg |
|  |             |              | A - B            | B = 42°         | Solder                 | <b>52-131.0252</b> | 8                |                | 0.006 kg |
|  |             |              | A - B            | B = 42°         | Solder 2.8 x 0.5 mm    | <b>52-131.022</b>  | 9                |                | 0.006 kg |

# 51 Raised design

| Switching system              | Contacts    | Diode 1N4007 | Switching action | Switching angle | Terminal            | Part No.           | Component layout | Wiring diagram | Weight   |
|-------------------------------|-------------|--------------|------------------|-----------------|---------------------|--------------------|------------------|----------------|----------|
| Snap-action switching element | 2 NC + 2 NO | 1            | A - B            | B = 42°         | Universal-Solder    | <b>52-745.0292</b> |                  | 10             | 0.010 kg |
|                               |             | 2            | A - B            | B = 42°         | Universal-Solder    | <b>52-746.0292</b> |                  | 11             | 0.010 kg |
|                               |             |              | A - B            | B = 42°         | Solder              | <b>52-132.0252</b> |                  | 12             | 0.006 kg |
|                               | 3 NC + 3 NO |              | A - B            | B = 42°         | Solder              | <b>52-133.0252</b> |                  | 13             | 0.006 kg |
|                               | 4 NC + 4 NO |              | A - B            | B = 42°         | Solder              | <b>52-134.0252</b> |                  | 14             | 0.006 kg |
|                               | 1 NC + 1 NO | 1            | A - C            | C = 90°         | Universal-Solder    | <b>52-747.0292</b> |                  | 20             | 0.008 kg |
|                               |             |              | A - C            | C = 90°         | Universal-Solder    | <b>52-748.0292</b> |                  | 21             | 0.008 kg |
|                               |             |              | A - C            | C = 90°         | Solder              | <b>52-271.0252</b> |                  | 22             | 0.006 kg |
|                               |             |              | A - C            | C = 90°         | Solder 2.8 x 0.5 mm | <b>52-271.022</b>  |                  | 23             | 0.006 kg |
|                               | 2 NC + 2 NO | 1            | A - C            | C = 90°         | Universal-Solder    | <b>52-749.0292</b> |                  | 24             | 0.010 kg |
|                               |             |              | A - C            | C = 90°         | Universal-Solder    | <b>52-750.0292</b> |                  | 25             | 0.010 kg |
|                               |             | 2            | A - C            | C = 90°         | Solder              | <b>52-272.0252</b> |                  | 26             | 0.006 kg |
|                               | 3 NC + 3 NO |              | A - C            | C = 90°         | Solder              | <b>52-273.0252</b> |                  | 27             | 0.006 kg |
|                               | 4 NC + 4 NO |              | A - C            | C = 90°         | Solder              | <b>52-274.0252</b> |                  | 28             | 0.006 kg |

Contacts: NC = Normally closed, NO = Normally open  
 Switching action: A = Rest, B = Momentary, C = Maintain  
 The component layouts you will find from page 76







# 51 Raised design

## Selector switch 3 positions, IP 65



Product can differ from the current configuration.



### Additional Information

- Illuminative

### Equipment consisting of (schematic overview)



Each Part Number listed below includes all the black components shown in the 3D-drawing.

To obtain a complete unit, please select the red components from the pages shown.

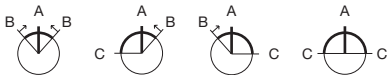

Switching positions (A = Rest, B = Momentary, C = Maintained)

| Switching system   | Contacts    | Switching action | Switching angle  | Terminal            | Part No.           | Wiring diagram | Weight   |
|--|-------------|------------------|------------------|---------------------|--------------------|----------------|----------|
|  <b>Selector switch 3 positions, Front dimension Ø 18 mm</b> |             |                  |                  |                     |                    |                |          |
| Snap-action switching element  | 2 NC + 2 NO | B - A - B        | B = 42° / 42°    | Solder 2.8 x 0.5 mm | <b>52-572.022A</b> | 1              | 0.015 kg |
|  |             | C - A - B        | C = 90°, B = 42° | Solder 2.8 x 0.5 mm | <b>52-574.022A</b> | 2              | 0.015 kg |
|  |             | B - A - C        | B = 42°, C = 90° | Solder 2.8 x 0.5 mm | <b>52-573.022A</b> | 3              | 0.015 kg |
|  |             | C - A - C        | C = 90° / 90°    | Solder 2.8 x 0.5 mm | <b>52-571.022A</b> | 4              | 0.015 kg |

Contacts: NC = Normally closed, NO = Normally open  
 Switching action: A = Rest, B = Momentary, C = Maintain





# 51 Raised design

Front

## Lens flush design

### Additional Information

- Lens surface mat
- Lens profile flat

| Product attribute   | Dimension  | Lens                   | Part No.         | Weight   |
|---|------------|------------------------|------------------|----------|
|  <b>Lens plastic, flush design</b>   |            |                        |                  |          |
| illuminative  | 18 x 18 mm | smoked transparent     | <b>61-9671.1</b> | 0.002 kg |
|   |            | red transparent        | <b>61-9671.2</b> | 0.002 kg |
|   |            | orange transparent     | <b>61-9671.3</b> | 0.002 kg |
|   |            | yellow transparent     | <b>61-9671.4</b> | 0.002 kg |
|   |            | green transparent      | <b>61-9671.5</b> | 0.002 kg |
|   |            | blue transparent       | <b>61-9671.6</b> | 0.002 kg |
|   |            | colourless transparent | <b>61-9671.7</b> | 0.002 kg |
| non-illuminative  | 18 x 18 mm | black opaque           | <b>61-9771.0</b> | 0.002 kg |
|   |            | grey opaque            | <b>61-9771.8</b> | 0.002 kg |
|   |            | white translucent      | <b>61-9771.9</b> | 0.002 kg |
|  <b>Lens plastic, flush design</b> |            |                        |                  |          |
| illuminative  | 18 x 24 mm | smoked transparent     | <b>61-9681.1</b> | 0.002 kg |
|   |            | red transparent        | <b>61-9681.2</b> | 0.002 kg |
|   |            | orange transparent     | <b>61-9681.3</b> | 0.002 kg |
|   |            | yellow transparent     | <b>61-9681.4</b> | 0.002 kg |
|   |            | green transparent      | <b>61-9681.5</b> | 0.002 kg |
|   |            | blue transparent       | <b>61-9681.6</b> | 0.002 kg |
|   |            | colourless transparent | <b>61-9681.7</b> | 0.002 kg |
| non-illuminative  | 18 x 24 mm | black opaque           | <b>61-9781.0</b> | 0.002 kg |
|   |            | white translucent      | <b>61-9781.9</b> | 0.002 kg |
|  <b>Lens plastic, flush design</b> |            |                        |                  |          |
| illuminative  | Ø 19.7 mm  | smoked transparent     | <b>61-9642.1</b> | 0.002 kg |
|   |            | red transparent        | <b>61-9642.2</b> | 0.002 kg |
|   |            | orange transparent     | <b>61-9642.3</b> | 0.002 kg |
|   |            | yellow transparent     | <b>61-9642.4</b> | 0.002 kg |
|   |            | green transparent      | <b>61-9642.5</b> | 0.002 kg |
|   |            | blue transparent       | <b>61-9642.6</b> | 0.002 kg |
|   |            | colourless transparent | <b>61-9642.7</b> | 0.002 kg |

Lens raised design

| Product attribute   | Dimension      | Lens                   | Part No.        | Weight   |
|---|----------------|------------------------|-----------------|----------|
|  <p><b>Lens plastic, raised design</b></p>   |                |                        |                 |          |
| flat, illuminative  | 15.3 x 15.3 mm | smoked transparent     | <b>51-953.1</b> | 0.001 kg |
|   |                | red transparent        | <b>51-953.2</b> | 0.001 kg |
|   |                | orange transparent     | <b>51-953.3</b> | 0.001 kg |
|   |                | yellow transparent     | <b>51-953.4</b> | 0.001 kg |
|   |                | green transparent      | <b>51-953.5</b> | 0.001 kg |
|   |                | blue transparent       | <b>51-953.6</b> | 0.001 kg |
|   |                | colourless transparent | <b>51-953.7</b> | 0.001 kg |
| flat, illuminative, not suitable for film insert  | 15.3 x 15.3 mm | red translucent        | <b>51-951.2</b> | 0.001 kg |
|   |                | orange translucent     | <b>51-951.3</b> | 0.001 kg |
|   |                | yellow translucent     | <b>51-951.4</b> | 0.001 kg |
|   |                | green translucent      | <b>51-951.5</b> | 0.001 kg |
|   |                | blue translucent       | <b>51-951.6</b> | 0.001 kg |
|   |                | white translucent      | <b>51-951.9</b> | 0.001 kg |
| flat, illuminative, less suitable for film insert   | 15.3 x 15.3 mm | red transparent        | <b>51-955.2</b> | 0.001 kg |
|   |                | yellow transparent     | <b>51-955.4</b> | 0.001 kg |
|   |                | green transparent      | <b>51-955.5</b> | 0.001 kg |
|   |                | colourless transparent | <b>51-955.7</b> | 0.001 kg |
| flat, non-illuminative  | 15.3 x 15.3 mm | black opaque           | <b>51-951.0</b> | 0.001 kg |
|   |                | grey opaque            | <b>51-951.8</b> | 0.001 kg |
|  <p><b>Lens plastic, raised design</b></p> |                |                        |                 |          |
| concave, illuminative   | 15.3 x 15.3 mm | red transparent        | <b>51-954.2</b> | 0.001 kg |
|   |                | orange transparent     | <b>51-954.3</b> | 0.001 kg |
|   |                | yellow transparent     | <b>51-954.4</b> | 0.001 kg |
|   |                | green transparent      | <b>51-954.5</b> | 0.001 kg |
|   |                | blue transparent       | <b>51-954.6</b> | 0.001 kg |
|   |                | colourless transparent | <b>51-954.7</b> | 0.001 kg |
|  <p><b>Lens plastic, raised design</b></p> |                |                        |                 |          |
| flat, illuminative  | 15.3 x 21.5 mm | smoked transparent     | <b>51-903.1</b> | 0.001 kg |
|   |                | red transparent        | <b>51-903.2</b> | 0.001 kg |
|   |                | orange transparent     | <b>51-903.3</b> | 0.001 kg |
|   |                | yellow transparent     | <b>51-903.4</b> | 0.001 kg |
|   |                | green transparent      | <b>51-903.5</b> | 0.001 kg |
|   |                | blue transparent       | <b>51-903.6</b> | 0.001 kg |
|   |                | colourless transparent | <b>51-903.7</b> | 0.001 kg |

# 51 Raised design

| Product attribute  | Dimension      | Lens                   | Part No.        | Weight   |
|--|----------------|------------------------|-----------------|----------|
| flat, illuminative, not suitable for film insert   | 15.3 x 21.5 mm | red translucent        | <b>51-901.2</b> | 0.001 kg |
|  |                | orange translucent     | <b>51-901.3</b> | 0.001 kg |
|  |                | yellow translucent     | <b>51-901.4</b> | 0.001 kg |
|  |                | green translucent      | <b>51-901.5</b> | 0.001 kg |
|  |                | blue translucent       | <b>51-901.6</b> | 0.001 kg |
|  |                | white translucent      | <b>51-901.9</b> | 0.001 kg |
| flat, illuminative, less suitable for film insert  | 15.3 x 21.5 mm | red transparent        | <b>51-905.2</b> | 0.001 kg |
|  |                | yellow transparent     | <b>51-905.4</b> | 0.001 kg |
|  |                | green transparent      | <b>51-905.5</b> | 0.001 kg |
|  |                | colourless transparent | <b>51-905.7</b> | 0.001 kg |
| flat, non-illuminative   | 15.3 x 21.5 mm | black opaque           | <b>51-901.0</b> | 0.001 kg |
|  |                | grey opaque            | <b>51-901.8</b> | 0.001 kg |
|  <b>Lens plastic, raised design</b>   |                |                        |                 |          |
| concave, illuminative  | 15.3 x 21.5 mm | red transparent        | <b>51-904.2</b> | 0.001 kg |
|  |                | orange transparent     | <b>51-904.3</b> | 0.001 kg |
|  |                | yellow transparent     | <b>51-904.4</b> | 0.001 kg |
|  |                | green transparent      | <b>51-904.5</b> | 0.001 kg |
|  |                | blue transparent       | <b>51-904.6</b> | 0.001 kg |
|  |                | colourless transparent | <b>51-904.7</b> | 0.001 kg |
| concave, illuminative, less suitable for film insert   | 15.3 x 21.5 mm | red transparent        | <b>51-906.2</b> | 0.001 kg |
|  |                | yellow transparent     | <b>51-906.4</b> | 0.001 kg |
|  |                | green transparent      | <b>51-906.5</b> | 0.001 kg |
|  |                | colourless transparent | <b>51-906.7</b> | 0.001 kg |
|  <b>Lens plastic, raised design</b> |                |                        |                 |          |
| flat, illuminative   | Ø 15.8 mm      | smoked transparent     | <b>51-933.1</b> | 0.001 kg |
|  |                | red transparent        | <b>51-933.2</b> | 0.001 kg |
|  |                | orange transparent     | <b>51-933.3</b> | 0.001 kg |
|  |                | yellow transparent     | <b>51-933.4</b> | 0.001 kg |
|  |                | green transparent      | <b>51-933.5</b> | 0.001 kg |
|  |                | blue transparent       | <b>51-933.6</b> | 0.001 kg |
|  |                | colourless transparent | <b>51-933.7</b> | 0.001 kg |
| flat, illuminative, not suitable for film insert   | Ø 15.8 mm      | red translucent        | <b>51-931.2</b> | 0.001 kg |
|  |                | orange translucent     | <b>51-931.3</b> | 0.001 kg |
|  |                | yellow translucent     | <b>51-931.4</b> | 0.001 kg |
|  |                | green translucent      | <b>51-931.5</b> | 0.001 kg |
|  |                | blue translucent       | <b>51-931.6</b> | 0.001 kg |
|  |                | white translucent      | <b>51-931.9</b> | 0.001 kg |
| flat, illuminative, less suitable for film insert  | Ø 15.8 mm      | red transparent        | <b>51-935.2</b> | 0.001 kg |
|  |                | yellow transparent     | <b>51-935.4</b> | 0.001 kg |
|  |                | green transparent      | <b>51-935.5</b> | 0.001 kg |
|  |                | colourless transparent | <b>51-935.7</b> | 0.001 kg |
| flat, non-illuminative   | Ø 15.8 mm      | black opaque           | <b>51-931.0</b> | 0.001 kg |
|  |                | grey opaque            | <b>51-931.8</b> | 0.001 kg |

**Lens plastic with symbol**

**Additional Information**

- Lens profile flat
- Illuminative
- The silvery coat is being applied on the lens (screen print) with an additional protective lacquer. Further information see «Technical data»

| Dimension  | Lens                   | Symbol   | Part No.           | Weight   |
|--|------------------------|----------|--------------------|----------|
|  <p><b>Lens plastic with symbol, flush design</b></p>   |                        |          |                    |          |
| Ø 19.7 mm  | red transparent        | Ring     | <b>61-9643.201</b> | 0.002 kg |
|  | orange transparent     | Ring     | <b>61-9643.301</b> | 0.002 kg |
|  | yellow transparent     | Ring     | <b>61-9643.401</b> | 0.002 kg |
|  | green transparent      | Ring     | <b>61-9643.501</b> | 0.002 kg |
|  | blue transparent       | Ring     | <b>61-9643.601</b> | 0.002 kg |
|  | colourless transparent | Ring     | <b>61-9643.701</b> | 0.002 kg |
|  <p><b>Lens plastic with symbol, flush design</b></p>  |                        |          |                    |          |
| Ø 19.7 mm  | red transparent        | ON/OFF   | <b>61-9643.202</b> | 0.002 kg |
|  | green transparent      | ON/OFF   | <b>61-9643.502</b> | 0.002 kg |
|  | blue transparent       | ON/OFF   | <b>61-9643.602</b> | 0.002 kg |
|  | colourless transparent | ON/OFF   | <b>61-9643.702</b> | 0.002 kg |
|  <p><b>Lens plastic with symbol, flush design</b></p> |                        |          |                    |          |
| Ø 19.7 mm  | red transparent        | Stand by | <b>61-9643.203</b> | 0.002 kg |
|  | green transparent      | Stand by | <b>61-9643.503</b> | 0.002 kg |
|  | blue transparent       | Stand by | <b>61-9643.603</b> | 0.002 kg |
|  | colourless transparent | Stand by | <b>61-9643.703</b> | 0.002 kg |

**Marking plate**

**Additional Information**

- Can be hot stamped
- Only applicable with lens round  
Part No. 61-9642.X

| Marking plate  | Part No.         | Weight   |
|--|------------------|----------|
|  <p><b>Marking plate for lens plastic round, flush design</b></p> |                  |          |
| colourless transparent   | <b>61-9707.7</b> | 0.001 kg |

# 51 Accessories

## Lens metal with spot

### Additional Information

- Lens surface mat
- Lens profile flat
- Illuminative

| Dimension  | Lens                           | Part No.          | Weight   |
|--|--------------------------------|-------------------|----------|
|  <p><b>Lens metal with spot, flush design</b></p> | Aluminium black anodized       | <b>61-9841.0A</b> | 0.002 kg |
|  | Aluminium red anodized         | <b>61-9841.2A</b> | 0.002 kg |
|  | Aluminium gold anodized        | <b>61-9841.4A</b> | 0.002 kg |
|  | Aluminium olive-green anodized | <b>61-9841.5A</b> | 0.002 kg |
|  | Aluminium blue anodized        | <b>61-9841.6A</b> | 0.002 kg |
|  | Aluminium natural anodized     | <b>61-9841.8A</b> | 0.002 kg |
|  | Ø 19.7 mm                      |                   |          |

## Lens metal

### Additional Information

- Lens surface mat
- Non-illuminative
- The colour of anodized aluminium parts can vary due to technical production reasons

| Product attribute  | Dimension      | Lens      | Part No.                       | Weight           |          |
|--|----------------|-----------|--------------------------------|------------------|----------|
|  <p><b>Lens metal, flush design</b></p> | flat           | Ø 19.7 mm | Aluminium black anodized       | <b>61-9841.0</b> | 0.002 kg |
|  |                |           | Aluminium red anodized         | <b>61-9841.2</b> | 0.002 kg |
|  |                |           | Aluminium gold anodized        | <b>61-9841.4</b> | 0.002 kg |
|  |                |           | Aluminium olive-green anodized | <b>61-9841.5</b> | 0.002 kg |
|  |                |           | Aluminium blue anodized        | <b>61-9841.6</b> | 0.002 kg |
|  |                |           | Aluminium natural anodized     | <b>61-9841.8</b> | 0.002 kg |
|  <p><b>Lens metal, flush design</b></p> | convex (domed) | Ø 19.7 mm | Aluminium black anodized       | <b>61-9842.0</b> | 0.003 kg |
|  |                |           | Aluminium red anodized         | <b>61-9842.2</b> | 0.003 kg |
|  |                |           | Aluminium olive-green anodized | <b>61-9842.5</b> | 0.003 kg |
|  |                |           | Aluminium blue anodized        | <b>61-9842.6</b> | 0.003 kg |
|  |                |           | Aluminium natural anodized     | <b>61-9842.8</b> | 0.003 kg |



**Mushroom-head cap****Additional Information**

- Non-illuminative

| Mushroom-head cap   | Part No.         | Weight   |
|---|------------------|----------|
|  <b>Mushroom-head cap, flush design, Front dimension Ø 32 mm</b> |                  |          |
| Plastic black   | <b>61-9593.0</b> | 0.004 kg |
| Plastic red   | <b>61-9593.2</b> | 0.004 kg |
| Plastic yellow  | <b>61-9593.4</b> | 0.004 kg |
| Plastic green   | <b>61-9593.5</b> | 0.004 kg |

**Front bezel for selector switch square****Additional Information**

- The dimensions of the mounting cut-outs are shown in the product details
- Please note that bigger minimum distances are necessary

| Dimension  | Front bezel   | Part No.        | Weight   |
|--|---------------|-----------------|----------|
|  <b>Front bezel for selector switch square, raised design</b> |               |                 |          |
| 24 x 24 mm   | Plastic black | <b>52-950.0</b> | 0.001 kg |
| 26 x 26 mm   | Plastic black | <b>52-952.0</b> | 0.001 kg |

## Lever flush design

### Additional Information

- With bar and marking dot

| Lever illumination  | Lever         | Bar colour | Part No.          | Weight   |
|---|---------------|------------|-------------------|----------|
|  <b>Lever flush design</b> |               |            |                   |          |
| illuminative  | Plastic black | red        | <b>61-9028.20</b> | 0.001 kg |
|   |               | yellow     | <b>61-9028.40</b> | 0.001 kg |
|   |               | green      | <b>61-9028.50</b> | 0.001 kg |
|   |               | blue       | <b>61-9028.60</b> | 0.001 kg |
|   | Plastic grey  | red        | <b>61-9029.20</b> | 0.001 kg |
|   |               | orange     | <b>61-9029.30</b> | 0.001 kg |
|   |               | yellow     | <b>61-9029.40</b> | 0.001 kg |
| non-illuminative  | Plastic black | black      | <b>61-9028.0</b>  | 0.001 kg |
|   |               | white      | <b>61-9028.9</b>  | 0.001 kg |
|   | Plastic grey  | grey       | <b>61-9029.8</b>  | 0.001 kg |
|   |               | white      | <b>61-9029.9</b>  | 0.001 kg |

## Lever raised design

### Additional Information

- With bar and marking dot

| Lever illumination   | Lever         | Bar colour | Part No.         | Weight   |
|--|---------------|------------|------------------|----------|
|  <b>Lever raised design</b> |               |            |                  |          |
| illuminative   | Plastic black | red        | <b>52-928.20</b> | 0.001 kg |
|  | Plastic black | orange     | <b>52-928.30</b> | 0.001 kg |
|  | Plastic black | yellow     | <b>52-928.40</b> | 0.001 kg |
|  | Plastic black | green      | <b>52-928.50</b> | 0.001 kg |
|  | Plastic black | blue       | <b>52-928.60</b> | 0.001 kg |
|  | Plastic grey  | red        | <b>52-929.20</b> | 0.001 kg |
|  | Plastic grey  | orange     | <b>52-929.30</b> | 0.001 kg |
|  | Plastic grey  | yellow     | <b>52-929.40</b> | 0.001 kg |
|  | Plastic grey  | green      | <b>52-929.50</b> | 0.001 kg |
|  | Plastic grey  | blue       | <b>52-929.60</b> | 0.001 kg |
| non-illuminative   | Plastic black | black      | <b>52-928.0</b>  | 0.001 kg |
|  | Plastic black | white      | <b>52-928.9</b>  | 0.001 kg |
|  | Plastic grey  | grey       | <b>52-929.8</b>  | 0.001 kg |
|  | Plastic grey  | white      | <b>52-929.9</b>  | 0.001 kg |

**Legend frame**

**Additional Information**

- For devices with front dimension  $\varnothing 25$  mm, flush design
- The colour of anodized aluminium parts can vary due to technical production reasons



Dimensions [mm]

| Dimension  | Material  | Colour         | Mounting type | Part No.         | Weight   |
|--|-----------|----------------|---------------|------------------|----------|
|  <p><b>Legend frame</b></p> |           |                |               |                  |          |
| 30 x 50 x 0.75 mm  | Aluminium | black anodized | adhesive      | <b>61-9980.0</b> | 0.001 kg |

**Legend plate**

**Additional Information**

- For legend frame Part No. 61-9980.0
- The colour of anodized aluminium parts can vary due to technical production reasons

| Dimension   | Material  | Colour           | Mounting type | Part No.         | Weight   |
|---|-----------|------------------|---------------|------------------|----------|
|  <p><b>Legend plate for legend frame</b></p> |           |                  |               |                  |          |
| 14.5 x 23.5 mm  | Aluminium | natural anodized | adhesive      | <b>704.968.0</b> | 0.001 kg |
|   |           | black anodized   | adhesive      | <b>704.968.1</b> | 0.001 kg |

## Front bezel set

### Additional Information

- The dimensions of the mounting cut-outs are shown in the product details
- The colour of anodized aluminium parts can vary due to technical production reasons

| Mounting cut-out   | Front bezel    | Part No.                       | Weight           |          |
|--|----------------|--------------------------------|------------------|----------|
|  <p><b>Front bezel set for indicator and illuminated pushbutton, flush design, Front dimension 24 x 24 mm</b></p> |                |                                |                  |          |
|  | 21 x 21 mm     | Plastic black                  | <b>61-9930.0</b> | 0.008 kg |
|  | Plastic silver | <b>61-9930.4</b>               | 0.008 kg         |          |
|  <p><b>Front bezel set for indicator and illuminated pushbutton, flush design, Front dimension 24 x 30 mm</b></p> |                |                                |                  |          |
|  | 21 x 27 mm     | Plastic black                  | <b>61-9931.0</b> | 0.008 kg |
|  | Plastic silver | <b>61-9931.4</b>               | 0.008 kg         |          |
|  <p><b>Front bezel set for indicator and illuminated pushbutton, flush design, Front dimension Ø 25 mm</b></p>  |                |                                |                  |          |
|  | Ø 22.5 mm      | Aluminium natural anodized     | <b>61-9933.0</b> | 0.006 kg |
|  |                | Aluminium black anodized       | <b>61-9933.1</b> | 0.006 kg |
|  |                | Aluminium red anodized         | <b>61-9933.2</b> | 0.006 kg |
|  |                | Aluminium gold anodized        | <b>61-9933.4</b> | 0.006 kg |
|  |                | Aluminium olive-green anodized | <b>61-9933.5</b> | 0.006 kg |
|  |                | Aluminium blue anodized        | <b>61-9933.6</b> | 0.006 kg |
| Plastic black  |                | <b>61-9933.10</b>              | 0.008 kg         |          |

**Front bezel set**

**Additional Information**

- Please note that bigger minimum distances are necessary
- The colour of anodized aluminium parts can vary due to technical production reasons

| Dimension  | Mounting cut-out | Front bezel                    | Part No.          | Weight   |
|--|------------------|--------------------------------|-------------------|----------|
|  <p><b>Front bezel set for mushroom-head pushbutton, flush design</b></p>                           |                  |                                |                   |          |
| Ø 25 mm  | Ø 22.5 mm        | Aluminium natural anodized     | <b>61-9933.0</b>  | 0.006 kg |
|  |                  | Aluminium black anodized       | <b>61-9933.1</b>  | 0.006 kg |
|  |                  | Plastic black                  | <b>61-9933.10</b> | 0.008 kg |
|  |                  | Aluminium red anodized         | <b>61-9933.2</b>  | 0.006 kg |
|  |                  | Aluminium gold anodized        | <b>61-9933.4</b>  | 0.006 kg |
|  |                  | Aluminium olive-green anodized | <b>61-9933.5</b>  | 0.006 kg |
|  |                  | Aluminium blue anodized        | <b>61-9933.6</b>  | 0.006 kg |
|  <p><b>Front bezel set for mushroom-head pushbutton, flush design, Front dimension Ø 40 mm</b></p> |                  |                                |                   |          |
|  | Ø 22.5 mm        | Aluminium natural anodized     | <b>61-9934.8</b>  | 0.013 kg |

## Front bezel set keylock switch

### Additional Information

- The Dimensions [mm] of the Mounting cut-outs [mm] are shown in the product details
- For the round front bezel sets the anti-twist ring is part of the sales-package
- The colour of anodized aluminium parts can vary due to technical production reasons

| Mounting cut-out   | Front bezel   | Part No.                       | Weight           |          |
|--|---------------|--------------------------------|------------------|----------|
|  <p><b>Front bezel set for keylock switch, flush design, Front dimension 24 x 24 mm</b></p> |               |                                |                  |          |
|  | 21 x 21 mm    | Plastic black                  | <b>61-9930.0</b> | 0.008 kg |
|  |               | Plastic silver                 | <b>61-9930.4</b> | 0.008 kg |
|  <p><b>Front bezel set for keylock switch, flush design, Front dimension 24 x 30 mm</b></p> |               |                                |                  |          |
|  | 21 x 27 mm    | Plastic black                  | <b>61-9931.0</b> | 0.008 kg |
|  |               | Plastic silver                 | <b>61-9931.4</b> | 0.008 kg |
|  <p><b>Front bezel set for keylock switch, flush design, Front dimension Ø 25 mm</b></p>   |               |                                |                  |          |
|  | Ø 22.5 mm     | Aluminium natural anodized     | <b>61-9932.0</b> | 0.006 kg |
|  |               | Aluminium black anodized       | <b>61-9932.1</b> | 0.006 kg |
|  |               | Aluminium red anodized         | <b>61-9932.2</b> | 0.006 kg |
|  |               | Aluminium gold anodized        | <b>61-9932.4</b> | 0.006 kg |
|  |               | Aluminium olive-green anodized | <b>61-9932.5</b> | 0.006 kg |
|  |               | Aluminium blue anodized        | <b>61-9932.6</b> | 0.006 kg |
|  | Plastic black | <b>61-9932.10</b>              | 0.008 kg         |          |

**Front bezel set for selector switch**

**Additional Information**

- The dimensions of the mounting cut-outs are shown in the product details
- For the round front bezel sets the anti-twist ring is part of the sales-package
- The colour of anodized aluminium parts can vary due to technical production reasons

| Mounting cut-out  | Front bezel                    | Part No.          | Weight   |
|---|--------------------------------|-------------------|----------|
|  <p><b>Front bezel set for selector switch, flush design, Front dimension 24 x 24 mm</b></p> |                                |                   |          |
| 21 x 21 mm  | Plastic black                  | <b>61-9936.0</b>  | 0.007 kg |
|  <p><b>Front bezel set for selector switch, flush design, Front dimension Ø 25 mm</b></p>    |                                |                   |          |
| Ø 22.5 mm   | Aluminium natural anodized     | <b>61-9932.0</b>  | 0.006 kg |
|   | Aluminium black anodized       | <b>61-9932.1</b>  | 0.006 kg |
|   | Aluminium red anodized         | <b>61-9932.2</b>  | 0.006 kg |
|   | Aluminium gold anodized        | <b>61-9932.4</b>  | 0.006 kg |
|   | Aluminium olive-green anodized | <b>61-9932.5</b>  | 0.006 kg |
|   | Aluminium blue anodized        | <b>61-9932.6</b>  | 0.006 kg |
|   | Plastic black                  | <b>61-9932.10</b> | 0.008 kg |

**Front protective cap, IP 68**

**Additional Information**

- For lenses with flat profile only
- When using the front protection cover for push buttons the external sealing in the front bezel set and the silicone bellows in the actuator are to be removed

| Product attribute  | Material | Colour     | Optics      | Part No.         | Weight   |
|--|----------|------------|-------------|------------------|----------|
|  <p><b>Front protective cap</b></p> |          |            |             |                  |          |
| for front bezel set 24 x 30 mm, flush design   | Silicone | colourless | transparent | <b>61-9927.2</b> | 0.001 kg |
|  <p><b>Front protective cap</b></p> |          |            |             |                  |          |
| for front bezel set Ø 25 mm, flush design  | Silicone | colourless | transparent | <b>84-9103.7</b> | 0.001 kg |

# 51 Accessories

## Protective cover flush design, IP 65

### Additional Information

- The Dimensions [mm] of the Mounting cut-outs [mm] are shown in the product details
- Please note that bigger minimum distances are necessary



Dimensions [mm]

| Product attribute   | Dimension  | Mounting cut-out | Material | Optics      | Part No.         | Weight   |
|---|------------|------------------|----------|-------------|------------------|----------|
|  <p><b>Protective cover flush design</b></p>  |            |                  |          |             |                  |          |
| hinged, with means for sealing  | 24 x 24 mm | 21 x 21 mm       | Plastic  | transparent | <b>61-9921.0</b> | 0.006 kg |
|  <p><b>Protective cover flush design</b></p>  |            |                  |          |             |                  |          |
| hinged, with means for sealing  | 24 x 30 mm | 21 x 27 mm       | Plastic  | transparent | <b>61-9922.0</b> | 0.006 kg |
|  <p><b>Protective cover flush design</b></p> |            |                  |          |             |                  |          |
| slide by side, with means not for sealing   | Ø 25 mm    | Ø 22.5 mm        | Plastic  | transparent | <b>61-9924.0</b> | 0.006 kg |



**Protective cover raised design, IP 65**

**Additional Information**

- Hinged, with means for sealing
- The dimensions of the mounting cut-outs are shown in the product details
- Please note that bigger minimum distances are necessary



Dimensions [mm]

| Dimension   | Mounting cut-out                      | Material | Optics      | Part No.      | Weight   |
|---|---------------------------------------|----------|-------------|---------------|----------|
|    | <b>Protective cover raised design</b> |          |             |               |          |
| 18 x 18 mm  | Ø 16 mm                               | Plastic  | transparent | <b>51-920</b> | 0.002 kg |
|  | <b>Protective cover raised design</b> |          |             |               |          |
| 18 x 24 mm  | Ø 16 mm                               | Plastic  | transparent | <b>51-925</b> | 0.002 kg |

**Blind plug flush design**

**Additional Information**

- The dimensions of the mounting cut-outs are shown in the product details

| Dimension   | Mounting cut-out               | Material | Colour | Part No.         | Weight   |
|---|--------------------------------|----------|--------|------------------|----------|
|  | <b>Blind plug flush design</b> |          |        |                  |          |
| 24 x 24 mm  | 21 x 21 mm                     | Plastic  | black  | <b>61-9451.0</b> | 0.006 kg |
|  | <b>Blind plug flush design</b> |          |        |                  |          |
| 24 x 30 mm  | 21 x 27 mm                     | Plastic  | black  | <b>61-9452.0</b> | 0.006 kg |
|  | <b>Blind plug flush design</b> |          |        |                  |          |
| Ø 25 mm   | Ø 22.5 mm                      | Plastic  | black  | <b>61-9453.0</b> | 0.006 kg |

# 51 Accessories

## Blind plug raised design

### Additional Information

- The dimensions of the mounting cut-outs are shown in the product details
- Blind plugs fit also in mounting cut-outs with anti-twist device

| Dimension  | Mounting cut-out | Material | Colour | Part No.        | Weight   |
|--|------------------|----------|--------|-----------------|----------|
|  <b>Blind plug raised design</b>  |                  |          |        |                 |          |
| 18 x 18 mm   | Ø 16 mm          | Plastic  | black  | <b>51-948.0</b> | 0.003 kg |
|  <b>Blind plug raised design</b>  |                  |          |        |                 |          |
| 18 x 24 mm   | Ø 16 mm          | Plastic  | black  | <b>51-947.0</b> | 0.003 kg |
|  <b>Blind plug raised design</b> |                  |          |        |                 |          |
| Ø 18 mm  | Ø 16 mm          | Plastic  | black  | <b>51-949.0</b> | 0.003 kg |

## Master key

### Additional Information

- For standard lock: DOM 311 ... 445

| Part No.   | Weight   |
|--|----------|
|  <b>Master key</b> |          |
| <b>31-989.300</b>  | 0.006 kg |

**Spare key**

**Additional Information**

- For standard lock: DOM 311
- Optional lock numbers on request

| Part No.  | Weight   |
|---|----------|
|  <p data-bbox="272 633 389 663"><b>Spare key</b></p> |          |
| 31-989.311  | 0.006 kg |

**EMC key protection cap**

**Additional Information**

- Plastic black
- For standard lock: DOM

| Part No.   | Weight   |
|--|----------|
|  <p data-bbox="272 1205 549 1234"><b>EMC key protection cap</b></p> |          |
| 31-985.0   | 0.005 kg |

## PCB plug-in base

### Additional Information

- PCB plug-in base pins right-angle: With the extendable mounting the distance between plug-in base and PCB can be varied up to 3 mm



Dimensions

| Product attribute   | Pins         | Terminal | Part No.      | Component layout | Weight   |
|---|--------------|----------|---------------|------------------|----------|
|  <p><b>PCB plug-in base</b><br/>for low level switching element</p>          | axial        | PCB      | <b>31-940</b> | 3                | 0.002 kg |
|  <p><b>PCB plug-in base</b><br/>for low level switching element</p>          | right-angled | PCB      | <b>31-941</b> | 1                | 0.004 kg |
|  <p><b>PCB plug-in base</b><br/>for snap-action switching element 2.8 mm</p> | axial        | PCB      | <b>31-942</b> | 2                | 0.002 kg |

The component layouts you will find from page 76

**Multi-plug housing**

**Additional Information**

- For switching block

| Part No.   | Weight   |
|--|----------|
|  <p data-bbox="272 595 488 629"><b>Multi-plug housing</b></p> |          |
| 51-943.0   | 0.005 kg |

## Flat receptacle

| Product attribute  | Part No.        | Weight   |
|--|-----------------|----------|
|  <p><b>Flat receptacle</b></p> |                 |          |
| 2.0 x 0.5 mm plug-in terminal  | <b>31-945</b>   | 0.001 kg |
|  <p><b>Flat receptacle</b></p> |                 |          |
| 2.8 x 0.5 mm plug-in terminal  | <b>31-946</b>   | 0.001 kg |
|  <p><b>Flat receptacle</b></p> |                 |          |
| 2.8 x 0.5 mm multi-plug housing  | <b>51-943.1</b> | 0.001 kg |

## Insulation sleeve

| Product attribute   | Part No.      | Weight   |
|---|---------------|----------|
|  <p><b>Insulation sleeve</b></p> |               |          |
| Cover plug-in terminals for snap-action switching element 2.8 mm  | <b>01-928</b> | 0.001 kg |
|  <p><b>Insulation sleeve</b></p>  |               |          |
| for flat receptacle 2.0 mm  | <b>31-928</b> | 0.001 kg |
|  <p><b>Insulation sleeve</b></p>  |               |          |
| for flat receptacle 2.8 mm  | <b>31-929</b> | 0.001 kg |

## Terminal cover

| Part No.   | Weight   |
|--|----------|
|  <p><b>Terminal cover for snap-action switching element 16</b></p> |          |
| <b>01-929</b>  | 0.010 kg |

**Illumination**

**LED, T1 3/4 MG**

**Additional Information**

- Due to high surface temperatures, the series resistor must not be soldered directly to the terminals of the equipment (use a terminal plate)• When using AC/DC types with AC operation, slight flickering can occur
- Luminous intensity data of the LEDs on direct voltage
- Electrical and optical data are measured at 25 °C
- The specified versions are built with a protection diode (half wave rectifier) in series and the LED
- When using AC/DC types with AC operation, slight flickering can occur
- Luminosity and wave length variations caused by LED manufacturing processes may cause slight differences regarding the illumination
- For supply voltages above 48 V, it is necessary to use a voltage reduction element (external series resistor or transformer)
- If the 24VDC Bi-colour lamp is driven with normal polarity (plus on middle contact of the lamp) the first mentioned colour will light up, with inverted polarity the second colour will light up



Dimensions [mm]

| LED colour   | Operating voltage | Operation current | Lumi. intensity | Dom. wavelength | Part No.            | Weight   |
|--|-------------------|-------------------|-----------------|-----------------|---------------------|----------|
|  <p><b>Single-LED</b></p> |                   |                   |                 |                 |                     |          |
| red  | 6 VDC +10 %       | 15 mA ±15 %       | 350 mcd         | 630 nm          | <b>10-2J06.3142</b> | 0.002 kg |
|  | 12 VAC/DC +10 %   | 7/14 mA ±15 %     | 330 mcd         | 630 nm          | <b>10-2J09.1062</b> | 0.002 kg |
|  | 24 VAC/DC +10 %   | 7/14 mA ±15 %     | 330 mcd         | 630 nm          | <b>10-2J12.1062</b> | 0.002 kg |
|  | 28 VAC/DC +10 %   | 7/14 mA ±15 %     | 330 mcd         | 630 nm          | <b>10-2J13.1062</b> | 0.002 kg |
|  | 48 VAC/DC +10 %   | 4/8 mA ±15 %      | 200 mcd         | 630 nm          | <b>10-2J19.1042</b> | 0.002 kg |
| yellow   | 6 VDC +10 %       | 15 mA ±15 %       | 300 mcd         | 587 nm          | <b>10-2J06.3144</b> | 0.002 kg |
|  | 12 VAC/DC +10 %   | 7/14 mA ±15 %     | 280 mcd         | 587 nm          | <b>10-2J09.1064</b> | 0.002 kg |
|  | 24 VAC/DC +10 %   | 7/14 mA ±15 %     | 280 mcd         | 587 nm          | <b>10-2J12.1064</b> | 0.002 kg |
|  | 28 VAC/DC +10 %   | 7/14 mA ±15 %     | 280 mcd         | 587 nm          | <b>10-2J13.1064</b> | 0.002 kg |
|  | 48 VAC/DC +10 %   | 4/8 mA ±15 %      | 180 mcd         | 587 nm          | <b>10-2J19.1044</b> | 0.002 kg |
| green  | 6 VDC +10 %       | 7 mA ±15 %        | 1050 mcd        | 525 nm          | <b>10-2J06.3145</b> | 0.002 kg |
|  | 12 VAC/DC +10 %   | 4/7 mA ±15 %      | 1050 mcd        | 525 nm          | <b>10-2J09.1065</b> | 0.002 kg |
|  | 24 VAC/DC +10 %   | 4/7 mA ±15 %      | 1050 mcd        | 525 nm          | <b>10-2J12.1065</b> | 0.002 kg |
|  | 28 VAC/DC +10 %   | 4/7 mA ±15 %      | 1050 mcd        | 525 nm          | <b>10-2J13.1065</b> | 0.002 kg |
|  | 48 VAC/DC +10 %   | 2/4 mA ±15 %      | 600 mcd         | 525 nm          | <b>10-2J19.1045</b> | 0.002 kg |
| blue   | 6 VDC +10 %       | 15 mA ±15 %       | 680 mcd         | 470 nm          | <b>10-2J06.3146</b> | 0.002 kg |
|  | 12 VAC/DC +10 %   | 7/14 mA ±15 %     | 650 mcd         | 470 nm          | <b>10-2J09.1066</b> | 0.002 kg |
|  | 24 VAC/DC +10 %   | 7/14 mA ±15 %     | 650 mcd         | 470 nm          | <b>10-2J12.1066</b> | 0.002 kg |
|  | 28 VAC/DC +10 %   | 7/14 mA ±15 %     | 650 mcd         | 470 nm          | <b>10-2J13.1066</b> | 0.002 kg |
|  | 48 VAC/DC +10 %   | 4/8 mA ±15 %      | 400 mcd         | 470 nm          | <b>10-2J19.1046</b> | 0.002 kg |

# 51 Accessories

| LED colour   | Operating voltage | Operation current | Lumi. intensity | Dom. wavelength | Part No.            | Weight   |
|--|-------------------|-------------------|-----------------|-----------------|---------------------|----------|
| white  | 6 VDC +10 %       | 6 mA ±15 %        | 900 mcd         | x0.31/y0.32 nm  | <b>10-2J06.3149</b> | 0.002 kg |
|  | 12 VAC/DC +10 %   | 3/6 mA ±15 %      | 900 mcd         | x0.31/y0.32 nm  | <b>10-2J09.1069</b> | 0.002 kg |
|  | 24 VAC/DC +10 %   | 2.5/5 mA ±15 %    | 750 mcd         | x0.31/y0.32 nm  | <b>10-2J12.1069</b> | 0.002 kg |
|  | 28 VAC/DC +10 %   | 2.5/5 mA ±15 %    | 750 mcd         | x0.31/y0.32 nm  | <b>10-2J13.1069</b> | 0.002 kg |
|  | 48 VAC/DC +10 %   | 4/8 mA ±15 %      | 400 mcd         | x0.31/y0.32 nm  | <b>10-2J19.1049</b> | 0.002 kg |
|  <p><b>Bi-colour LED</b></p> |                   |                   |                 |                 |                     |          |
| red/green  | 24 VDC +10 %DC    | 15/14mA ±15 %     | 600/630 mcd     | 625/525 nm      | <b>10-A312.314A</b> | 0.002 kg |

## Filament lamp, T1 3/4 MG

| Operating voltage   | Operation current | Part No.            | Weight   |
|---|-------------------|---------------------|----------|
|  <p><b>Filament lamp</b></p> |                   |                     |          |
| 6 VAC/DC  | 120 mA ±10 %      | <b>10-1306.1349</b> | 0.001 kg |
| 6.3 VAC/DC  | 200 mA ±10 %      | <b>10-1307.1369</b> | 0.001 kg |
| 12 VAC/DC   | 75 mA ±10 %       | <b>10-1309.1309</b> | 0.001 kg |
| 14 VAC/DC   | 80 mA ±10 %       | <b>10-1310.1319</b> | 0.001 kg |
| 18 VAC/DC   | 40 mA ±10 %       | <b>10-1311.1249</b> | 0.001 kg |
| 24 VAC/DC   | 35 mA ±10 %       | <b>10-1312.1229</b> | 0.001 kg |
| 28 VAC/DC   | 30 mA ±10 %       | <b>10-1313.1209</b> | 0.001 kg |
|   | 40 mA ±10 %       | <b>10-1313.1249</b> | 0.001 kg |
| 36 VAC/DC   | 20 mA ±10 %       | <b>10-1316.1179</b> | 0.001 kg |
|   | 30 mA ±10 %       | <b>10-1316.1209</b> | 0.001 kg |
| 48 VAC/DC   | 20 mA ±10 %       | <b>10-1319.1179</b> | 0.001 kg |
|   | 25 mA ±10 %       | <b>10-1319.1199</b> | 0.001 kg |



**Series resistor**

**Additional Information**

- Only for filament lamp 48 VAC, 25 mA
- For lamp voltage reduction
- Keep to the country specific safety instructions
- Due to high surface temperatures, the series resistors must be soldered directly to the terminals of the equipment (use a terminal plate)

| Operating voltage   | Resistance | Part No.        | Weight   |
|---|------------|-----------------|----------|
|  <p><b>Series resistor</b></p> |            |                 |          |
| 110 VAC   | 2.7 kOhm   | <b>02-904.0</b> | 0.003 kg |
| 125 VAC   | 3.3 kOhm   | <b>02-904.1</b> | 0.003 kg |
| 145 VAC   | 4.7 kOhm   | <b>02-904.3</b> | 0.003 kg |
| 240 VAC   | 10 kOhm    | <b>02-904.7</b> | 0.003 kg |

**Terminal plate empty**

**Additional Information**

- For fitting with series resistors

| Product attribute  | Dimension          | Part No.        | Weight   |
|--|--------------------|-----------------|----------|
|  <p><b>Terminal plate empty</b></p> |                    |                 |          |
| 5 spaces   | 62.5 x 60 x 15 mm  | <b>02-912.1</b> | 0.025 kg |
| 10 spaces  | 125 x 60 x 15 mm   | <b>02-912.2</b> | 0.045 kg |
| 15 spaces  | 187.6 x 60 x 15 mm | <b>02-912.3</b> | 0.090 kg |
| 20 spaces  | 250 x 60 x 15 mm   | <b>02-912.4</b> | 0.095 kg |

## Mounting

### Fixing nut

#### Additional Information

- Special recommended for keylock switches

| Material   | Part No.      | Weight   |
|--|---------------|----------|
|  <p><b>Fixing nut</b></p> |               |          |
| Metal  | <b>31-991</b> | 0.005 kg |
|  <p><b>Fixing nut</b></p> |               |          |
| Plastic  | <b>51-991</b> | 0.005 kg |

### Anti-twist ring

#### Additional Information

- For key lock- and selector switch

| Part No.  | Weight   |
|---|----------|
|  <p><b>Anti-twist ring</b></p> |          |
| <b>51-910</b>   | 0.001 kg |

### Lens remover

| Product attribute   | Part No.         | Weight   |
|---|------------------|----------|
|  <p><b>Lens remover</b></p> |                  |          |
| for raised design   | <b>02-905</b>    | 0.011 kg |
|  <p><b>Lens remover</b></p> |                  |          |
| for flush design  | <b>61-9730.0</b> | 0.011 kg |

**Lamp remover**

**Additional Information**

▲ **Caution:** A switching process might be released when replacing the lamp

| Part No.   | Weight   |
|--|----------|
|  <p><b>Lamp remover</b></p> |          |
| 61-9740.0  | 0.003 kg |

**Mounting tool**

| Product attribute  | Part No.      | Weight   |
|--|---------------|----------|
|  <p><b>Mounting tool</b></p> |               |          |
| for tightening or loosening of the fixing nut  | <b>01-907</b> | 0.020 kg |

**Dismantling tool**

**Additional Information**

- For dismantling of lens, lens holder and switching element block

| Part No.   | Weight   |
|--|----------|
|  <p><b>Dismantling tool</b></p> |          |
| 51-938   | 0.027 kg |



**Actuator with snap-action switching element block (Keylock- and Selector switch 3 positions)**
**Switching system**

Self-cleaning, double-break snap action switching system  
1 normally closed and 1 normally open contact per element.

**Material**

**Material of contact**  
Gold plated hardsilver

**Switch housing**  
Diallylphthalate (DAP), heat-resistant and self-extinguishing

**Actuator housing**  
Polyetherimide, self-extinguishing

**Mechanical characteristics**

**Terminals**  
Soldering terminal which can also be used as plug-in terminal  
2.8 x 0.5mm:  
Max. wire diameter 2 wires of 1 mm  
Max. wire cross-section of stranded cable 2 x 0.75 mm<sup>2</sup>

**Tightening torque**  
for fixing nut max. 50Ncm

**Actuating torque**  
2.5Ncm...5.5Ncm, depending on the number of switching elements. Measured at the key or lever of the keylock- or selector switch.

**Actuating travel**  
Keylock-/selector switch actuator with 3 positions  
2 x ca. 42° deflection momentary action  
2 x ca. 90° deflection maintained action

**Rebound time**  
≤ 5 ms

**Mechanical lifetime**  
Keylock switch 50 000 cycles of operation  
Selector switch 100 000 cycles of operation

**Electrical characteristics**

**Electrostatic discharge (ESD)**  
≤ 15KV (Keylock switch)

**Conventional free air thermal current**  
5A  
The maximum current in continuous operation and at ambient temperature not exceeding the quoted maximum values.

**Switch rating**  
250VAC, 5A (cosφ 0.75)

**Electric strength**  
2500VAC, 50Hz, 1 min. between all terminals and earth, as per IEC 60512-2-11

**Protection class**  
II

**Environmental conditions**

**Storage temperature**  
-40°C...+85°C

**Service temperature**  
-25°C...+55°C  
for selector switches mounted as a block, make sure the heat can escape freely

**Protection degree**  
Front side, as per IEC 60529  
IP 65 keylock switch  
IP 40 selector switch

**Approvals**

**Approbations**  
CB (IEC 61058)  
CSA  
CQC  
ENEC (EN 61058)  
Germanischer Lloyd  
UL

**Declaration of conformity**  
CE

## Actuator with low level switching element

### Switching system

This low level switching element was designed for switching low powers in electronic circuits. The mechanism assures reliable switching of loads ranging from a few  $\mu\text{A}/\mu\text{V}$  up to 100 mA/42 VAC/DC.

Single-break momentary contact, as normally open or normally closed with 4 independent points of contact. 2 momentary contacts per switching element; combination of normally open and normally closed is possible.

Special features are the long life, extremely short rebound time and stable contact resistance.

### Material

#### Material of contact

Gold plated

#### Switch housing

Polysulfone, heat-resistant and self-extinguishing

#### Actuator housing

Polyetherimide, self-extinguishing

### Mechanical characteristics

#### Terminals

The universal terminals permit these units to be mounted on printed circuit boards (PCB). These terminals can also be used as soldering or plug-in terminals.

For these terminals we can also supply a plug-in base which, when soldered on to the board, enables the switch to be plugged in.

Soldering terminal:

Max. wire diameter 2 wires  $\leq 0.8\text{mm}$

Max. wire cross-section of stranded cable  $1 \times 0.75\text{mm}^2$

Plug-in terminal  $2.0 \times 0.5\text{mm}$

#### Tightening torque

for fixing nut max. 50 Ncm

#### Actuating torque

2.5 Ncm ... 5.5 Ncm, measured at the key or lever of the keylock- or selector switch

#### Actuating force

3 N ... 3.5 N

### Actuating travel

Illuminated pushbutton 3 mm

Keylock-/selector switch actuator 2 positions:

1 x ca.  $42^\circ$  deflection momentary action

1 x ca.  $90^\circ$  deflection maintained action

### Rebound time

Typ.  $< 100\mu\text{s}$

### Mechanical lifetime

Momentary action 5 million cycles of operation

Maintained action 1 million cycles of operation

Keylock switch 50 000 cycles of operation

### Electrical characteristics

#### Contact resistance

Starting value (initial)  $\leq 50\text{m}\Omega$

#### Electrostatic breakdown value

$\leq 15\text{KV}$  (Keylock switch)

#### Switch rating

$10\mu\text{A}$ ,  $100\mu\text{V}$  to 100 mA at 42 VAC/VDC

#### Electric strength

2500 VAC, 50 Hz, 1 min. between all terminals and earth, as per IEC 60512-2-11

### Environmental conditions

#### Storage temperature

$-40^\circ\text{C} \dots +85^\circ\text{C}$

#### Service temperature

$-25^\circ\text{C} \dots +55^\circ\text{C}$

For indicators and illuminated pushbuttons mounted as a block, make sure the heat can escape freely.

#### Protection degree

IP 65 front side, as per IEC 60529

#### Shock resistance

(Single impacts, semi-sinusoidal)

15 g for 11 ms, as per IEC 60512-4-3, IEC 60068-2-27

**Actuator with snap-action switching element**
**Switching system**

Self-cleaning, double-break snap action switching system (with contact gap 2 x 0.5 mm).  
 1 normally closed and 1 normally open contact per element.  
 Snap-action switching elements with soldering terminals at the sides: up to 4 switching element can be on a pushbutton (max. 4 normally closed and 4 normally open contacts).  
 Snap-action switching element with axial plug-in terminals 2.8 mm is not stackable, only 1 switching element can be on a pushbutton.

**Material**
**Material of contact**

Gold plated silver

**Switch housing**

Axial soldering-/plug-in terminal 2.8 mm:  
 Diallylphthalate DAP, Polyamide 66, Polysulfone, heat-resistant and self-extinguishing.

Soldering terminal: PA 6.6 Ultramid

**Actuator housing**

Polyetherimide, self-extinguishing

**Mechanical characteristics**
**Terminals**

Snap-action switching element with tinned soldering terminals at the sides:

Max. wire diameter 2 wires à 1.2 mm

Max. wire cross-section of stranded cable 1 x 1 mm<sup>2</sup>

Snap-action switching element with axial soldering terminals, which can also be used as plug-in terminals 2.8 x 0.5 mm:

Max. wire diameter 2 wires of 1 mm

Max. wire cross-section of stranded cable 2 of 0.75 mm<sup>2</sup> or 1 x 1.0 mm<sup>2</sup>

**Tightening torque**

for fixing nut max. 50 Ncm

**Actuating torque**

2.5 Ncm ... 5.5 Ncm, depending on the number of switching elements. Measured at the key or lever of the keylock- or selector switch.

**Actuating force**

4 N ... 6 N, depending on the number of switching elements

**Actuating travel**

Illuminated pushbutton 3 mm

Keylock-/selector switch actuator 2 positions:

1 x ca. 42° deflection momentary action

1 x ca. 90° deflection maintained action

**Rebound time**

≤ 5 ms

**Mechanical lifetime**

Momentary action 2 million cycles of operation

Maintained action 1 million cycles of operation

Keylock switch 50 000 cycles of operation

**Electrical characteristics**
**Standards**

IEC 61058, EN 61058

**Rated voltage**

250 VAC/VDC

**Rated current**

5 A

**Contact resistance**

Starting value (initial) ≤ 50 mΩ

**Electrostatic discharge (ESD)**

≤ 15 kV (Keylock switch)

**Conventional free air thermal current**

5 A

The maximum current in continuous operation and at ambient temperature not exceeding the quoted maximum values.

**Switch rating**

250 VAC, 5 A (cos φ 1)

250 VAC, 3 A (cos φ 0.3)

Switch rating AC (cos φ 0.7)

Voltage 125 VAC 250 VAC

Current 3 A 2 A

Switch rating DC (inductive) L: R = 30 ms

Voltage 24 VDC 60 VDC 110 VDC 220 VDC

Current 2 A 0.7 A 0.2 A 0.1 A

**Electric strength**

2500 VAC, 50 Hz, 1 min. between all terminals and earth, as per IEC 60512-2-11

**Protection class**

II

**Environmental conditions**
**Storage temperature**

-40 °C ... +85 °C

**Service temperature**

-25 °C ... +55 °C

For indicators and illuminated pushbuttons mounted as a block, make sure the heat can escape freely.

**Protection degree**

IP 65 front side, as per IEC 60529

## Shock resistance

(Single impacts, semi-sinusoidal)  
15 g for 11 ms, as per IEC 60512-4-3, IEC 60068-2-27

## Vibration resistance

(Sinusoidal)  
10 g at 10 Hz ... 1500 Hz, amplitude 0.75 mm,  
as per IEC 60512-4-4, IEC 60068-2-6

## Climate resistance

Standard condition, as per IEC 60068-2-3 and 2-30  
Changing condition, as per IEC 60068-2-14 and 2-33

## Approvals

### Approbations

CB (IEC 61058)  
CSA  
ENEC (EN 61058)  
Germanischer Lloyd  
UL

### Declaration of conformity

CE

## Stop Switch

### Switching system

#### Switching element SE16 with solder terminal

Self-cleaning, double-break snap-action switching system  
1 NC contact and 1 NO contact per switching element.  
Available with up to two switching elements (2 NC contact and 2 NO contact)

#### Switching element SE 2.8mm with solder-/ plug-in terminal

Self-cleaning, double-break snap-action switching system  
(1 NC contact and 1 NO contact)

#### Low-level switching element with universal terminal

Single-break momentary contact switch system. Two contacts per switching element with a combination of NC and NO contacts

## Material

### Actuator housing

Polyamide (PA66), Thermoplastic elastomer (TPE)

### Lens

Polyamide (PA6)

### Actuator

Polybutylene Terephthalate (PBT)

### Label

R-640 polyester

### Switching element

|                               |  |
|-------------------------------|--|
| Solder terminal               | Polyamide (PA 6.6)   |
| Solder-/plug-in interterminal | Diallyl Phthalate (DAP), Polyamide (PA), Polysulfone (PSU) |
| Universal terminal            | Polysulfone (PSU)  |

### Contact material

|                                       |                    |
|---------------------------------------|--------------------|
| Snap action solder terminal           | gold-plated silver |
| Snap action plug-in/solder terminal   | gold-plated silver |
| Low level plug-in/solder/PCB terminal | gold-plated        |

## Mechanical characteristics

### Terminals

Solder or solder/plug terminal, 2.8 × 0.5 mm  
Universal terminal with 2.0 × 0.5 mm plug-in/solder and PCB terminal

### Tightening torque

for fixing nut max. 50 Ncm

### Actuating force

4 ... 6 N (depending on the switching element)

### Mechanical lifetime

100 000 cycles of operation

## Electrical characteristics

### Switch rating

|                          |   |
|--------------------------|---|
| Solder terminal          | min. 5 VAC/DC, 1 mA<br>max. 250 VAC/DC, 5 A |
| Solder-/plug-in terminal | min. 5 VAC/DC, 1 mA<br>max. 250 VAC/DC, 5 A |
| Universal terminal       | min. 100 μV/10 μA<br>max. 42 VAC/DC, 100 mA |

## Environmental conditions

### Storage temperature

-40 °C ... +85 °C

### Operating temperature

-25 °C ... +55 °C

### Degree of front protection

IP 65

## Approvals

### Approbations

UL  
CSA  
CB  
ENEC (EN 61058)

### Declaration of conformity

CE

Approvals are not valid for Stop switches with Low-Level switching element.

*EAO reserves the right to alter specifications without further notice.*



## General notes

### 1. Engraving

In addition to the most commonly used world languages, in DIN1451-3 close spacing, other typefaces are available as Scandinavian, Slavic, Greek, Russian and Polish. Red, blue and black lenses are filled with white colour. Other colour lenses are filled in black. Standard height of letters is 2mm. If the height is not specified, we will supply 2mm engraved letters.

### 2. Hot stamping

For larger series it is worth considering markings by means of hot stamping. We will be pleased to advise you. For letters and figures, typefaces with 2.5mm, 3mm and 4mm are available.

### 3. Film inserts

Instead of using engraving the lenses can be fitted with transparent film inserts, as an alternative. For this purpose, though, it is advisable to use transparent lenses. In the case of use of a smoke-black lens the fitted film becomes readable only if the lamp is on. The film thickness is 0.2mm. Important : Consider push-button mounting orientation before specifying engraving characters!

## Lenses for indicators and illuminated pushbuttons, raised mounting

All dimensions in mm

| Front size (Lens)     | Film insert max. size | Height of letters h | Number of lines | Number of capital letters per line (target value) | Number of small letters per line (target value) | Image |
|-----------------------|-----------------------|---------------------|-----------------|---|---|-------|
| 18 x 18 (15.3 x 15.3) | 12.7 x 12.7           | 2                   | 4               | 7-8   | 8   | B3    |
|                       |                       | 3                   | 3               | 6-7   | 7   | B3    |
|                       |                       | 4                   | 2               | 4-5   | 5   | B3    |
|                       |                       | 5                   | 2               | 3-4   | 4   | B3    |
|                       |                       | 6                   | 1               | 3   | 3-4   | B3    |
|                       |                       | 8                   | 1               | 2-3   | 2-3   | B3    |
| 18 x 24 (15.3 x 21.5) | 12.7 x 18.7           | 2                   | 4               | 11  | 12  | B1    |
|                       |                       |                     | 5               | 7-8   | 8   | B2    |
|                       |                       | 3                   | 3               | 9-10  | 10-11   | B1    |
|                       |                       |                     | 4               | 6-7   | 7   | B2    |
|                       |                       | 4                   | 2               | 7   | 7-8   | B1    |
|                       |                       |                     | 3               | 4-5   | 5   | B2    |
|                       |                       | 5                   | 2               | 5-6   | 6   | B1    |
|                       |                       |                     |                 | 3-4   | 4   | B2    |
|                       |                       | 6                   | 1               | 4-5   | 5   | B1    |
|                       |                       |                     | 2               | 3   | 3-4   | B2    |
|                       |                       | 8                   | 1               | 3-4   | 3-4   | B1    |
|                       |                       |                     |                 | 2-3   | 2-3   | B2    |
| Ø 18 (Ø 15.8)         | Ø 12.8                | 2                   | 3               | 6   | 6   | B4    |
|                       |                       | 3                   | 2               | 5   | 6   | B4    |
|                       |                       | 4                   | 2               | 3   | 4   | B4    |
|                       |                       | 5                   | 1               | 2   | 3   | B4    |
|                       |                       | 6                   | 1               | 2   | 2   | B4    |
|                       |                       | 8                   | 1               | 2   | 2   | B4    |



# 51 Marking

## Lenses for indicators and illuminated pushbuttons, flush mounting

All dimensions in mm

| Front size (Lens) | Film insert max. size | Height of letters h | Number of lines | Number of capital letters per line (target value) | Number of small letters per line (target value) | Image |
|-------------------|-----------------------|---------------------|-----------------|---|---|-------|
| 24 x 24 (18 x 18) | 15.1 x 15.1           | 2                   | 4               | 8-9   | 9   | B3    |
|                   |                       | 3                   | 3               | 7-8   | 8   | B3    |
|                   |                       | 4                   | 2               | 4-5   | 5   | B3    |
|                   |                       | 5                   | 2               | 4   | 4-5   | B3    |
|                   |                       | 6                   | 1               | 4   | 4   | B3    |
|                   |                       | 8                   | 1               | 2-3   | 2-3   | B3    |
| 24 x 30 (18 x 24) | 15.1 x 21             | 2                   | 4               | 12  | 13  | B1    |
|                   |                       |                     | 5               | 8-9   | 9   | B2    |
|                   |                       | 3                   | 3               | 10-11   | 11-12   | B1    |
|                   |                       |                     | 4               | 7-8   | 8   | B2    |
|                   |                       | 4                   | 2               | 7   | 8   | B1    |
|                   |                       |                     | 3               | 4-5   | 5   | B2    |
|                   |                       | 5                   | 2               | 5-6   | 6   | B1    |
|                   |                       |                     |                 | 4   | 4-5   | B2    |
|                   |                       | 6                   | 1               | 4-5   | 5   | B1    |
|                   |                       |                     | 2               | 3   | 3-4   | B2    |
|                   |                       | 8                   | 1               | 3-4   | 3-4   | B1    |
|                   |                       |                     |                 | 2-3   | 2-3   | B2    |
| Ø 25 (Ø 19.7)     | Marking plate         | 2                   | 3               | 6   | 6   | B4    |
|                   |                       | 3                   | 2               | 5   | 6   | B4    |
|                   |                       | 4                   | 2               | 3   | 4   | B4    |
|                   |                       | 5                   | 1               | 2   | 3   | B4    |
|                   |                       | 6                   | 1               | 2   | 3   | B4    |
|                   |                       | 8                   | 1               | 2   | 2   | B4    |



## Suppressor circuits

When switching inductive loads such as relays, DC motors, and DC solenoids, it is always important to absorb surges (e.g. with a diode) to protect the contacts. When these inductive loads are switched off, a counter emf can severely damage switch contacts and greatly shorten lifetime.

Fig. 1 shows an inductive load with a free-wheeling diode connected in parallel. This free-wheeling diode provides a path for the inductor current to flow when the current is interrupted by the switch. Without this free-wheeling diode, the voltage across the coil will be limited only by dielectric breakdown voltages of the circuit or parasitic elements of the coil. This voltage can be kilovolts in amplitude even when nominal circuit voltages are low (e.g. 12VDC) see Fig. 2.

The free-wheeling diode should be chosen so that the reverse breakdown voltage is greater than the voltage driving the inductive load. The DC blocking voltage ( $V_R$ ) of the free-wheeling diode can be found in the datasheet of a diode. The forward current should be equal or greater than the maximum current flowing through the load.

**To get an efficient protection, the free-wheeling diode must be connected as close as possible to the inductive load!**

Switching with inductive load  
Fig. 1



Counter EMF  
over load without free-wheeling diode  
Fig. 2



## Index from Part No.

| Part No.     | Page | Part No.      | Page | Part No.      | Page | Part No.      | Page | Part No.      | Page | Part No.     | Page |
|--------------|------|---------------|------|---------------|------|---------------|------|---------------|------|--------------|------|
| 01-907       | 75   | 51-051.006F   | 4    | 51-153.0265   | 39   | 51-255.025D2F | 15   | 51-338.025D2  | 43   | 51-412.036DF | 17   |
| 01-928       | 70   | 51-051.006F   | 7    | 51-153.0266   | 40   | 51-256.025    | 37   | 51-338.025D2F | 47   | 51-414.036D  | 43   |
| 01-929       | 70   | 51-051.006F   | 8    | 51-153.0268   | 40   | 51-256.0250   | 38   | 51-355.022D   | 41   | 51-414.036DF | 17   |
| 02-904.0     | 73   | 51-121.022    | 34   | 51-154.0252   | 34   | 51-256.0254   | 37   | 51-355.022DF  | 16   | 51-415.036D  | 43   |
| 02-904.1     | 73   | 51-121.0252   | 34   | 51-154.0252F  | 5    | 51-256.0255   | 37   | 51-355.025D2  | 41   | 51-415.036DF | 17   |
| 02-904.3     | 73   | 51-122.0252   | 34   | 51-154.0252F  | 9    | 51-256.0256   | 38   | 51-355.025D2F | 15   | 51-417.036DF | 17   |
| 02-904.7     | 73   | 51-123.0252   | 34   | 51-154.0252F  | 11   | 51-256.0258   | 38   | 51-356.025D2  | 42   | 51-418.036D  | 43   |
| 02-905       | 74   | 51-124.0252   | 34   | 51-154.0252F  | 13   | 51-256.025D2  | 42   | 51-356.025D2F | 16   | 51-418.036DF | 17   |
| 02-912.1     | 73   | 51-131.022    | 34   | 51-155.022D   | 42   | 51-256.025D2F | 16   | 51-357.025D2F | 16   | 51-421.036   | 34   |
| 02-912.2     | 73   | 51-131.0252   | 34   | 51-155.022DF  | 16   | 51-256.026    | 37   | 51-358.025D2  | 42   | 51-422.036   | 34   |
| 02-912.3     | 73   | 51-132.0252   | 35   | 51-155.025D2  | 41   | 51-256.0260   | 38   | 51-358.025D2F | 16   | 51-422.036   | 34   |
| 02-912.4     | 73   | 51-133.0252   | 35   | 51-155.025D2F | 15   | 51-256.0264   | 37   | 51-361.022D   | 45   | 51-425.036   | 34   |
| 10-1306.1349 | 72   | 51-134.0252   | 35   | 51-156.0250   | 40   | 51-256.0265   | 37   | 51-361.022DF  | 20   | 51-426.036   | 34   |
| 10-1307.1369 | 72   | 51-135.022D   | 43   | 51-156.0252   | 39   | 51-256.0266   | 38   | 51-362.022D   | 45   | 51-427.036D  | 42   |
| 10-1309.1309 | 72   | 51-135.022DF  | 17   | 51-156.0254   | 39   | 51-256.0268   | 38   | 51-362.022DF  | 20   | 51-427.036DF | 16   |
| 10-1310.1319 | 72   | 51-135.025D2  | 43   | 51-156.0255   | 39   | 51-257.025D2  | 42   | 51-363.022D   | 45   | 51-428.036D  | 42   |
| 10-1311.1249 | 72   | 51-135.025D2F | 17   | 51-156.0256   | 40   | 51-257.025D2F | 16   | 51-363.022DF  | 20   | 51-428.036DF | 16   |
| 10-1312.1229 | 72   | 51-136.025D2  | 43   | 51-156.0258   | 40   | 51-258.025D2  | 42   | 51-364.022D   | 45   | 51-431.036   | 34   |
| 10-1313.1209 | 72   | 51-136.025D2F | 17   | 51-156.025D2  | 42   | 51-258.025D2F | 16   | 51-364.022DF  | 20   | 51-433.036   | 34   |
| 10-1313.1249 | 72   | 51-137.025D2  | 43   | 51-156.025D2F | 16   | 51-259.025    | 37   | 51-365.022D   | 45   | 51-435.036   | 34   |
| 10-1316.1179 | 72   | 51-137.025D2F | 17   | 51-156.0260   | 40   | 51-259.0250   | 38   | 51-365.022DF  | 20   | 51-436.036   | 34   |
| 10-1316.1209 | 72   | 51-138.025D2  | 43   | 51-156.0262   | 39   | 51-259.0254   | 37   | 51-366.022D   | 45   | 51-437.036DF | 17   |
| 10-1319.1179 | 72   | 51-138.025D2F | 17   | 51-156.0264   | 39   | 51-259.0255   | 37   | 51-366.022DF  | 20   | 51-443.036D  | 43   |
| 10-1319.1199 | 72   | 51-141.022D   | 43   | 51-156.0265   | 39   | 51-259.0256   | 38   | 51-367.022DF  | 20   | 51-438.036DF | 17   |
| 10-2J06.3142 | 71   | 51-141.022DF  | 17   | 51-156.0266   | 40   | 51-259.0258   | 38   | 51-368.022DF  | 20   | 51-441.036D  | 41   |
| 10-2J06.3144 | 71   | 51-141.025D2  | 43   | 51-156.0268   | 40   | 51-261.022    | 34   | 51-371.022D   | 46   | 51-441.036DF | 15   |
| 10-2J06.3145 | 71   | 51-141.025D2F | 17   | 51-157.025D2  | 42   | 51-261.0252   | 34   | 51-371.022DF  | 20   | 51-441.036DF | 41   |
| 10-2J06.3146 | 71   | 51-142.025D2  | 43   | 51-157.025D2F | 16   | 51-262.0252   | 34   | 51-372.022D   | 46   | 51-442.036DF | 15   |
| 10-2J06.3149 | 72   | 51-142.025D2F | 17   | 51-158.025D2  | 42   | 51-263.0252   | 34   | 51-372.022DF  | 20   | 51-444.036D  | 41   |
| 10-2J09.1062 | 71   | 51-143.025D2  | 43   | 51-158.025D2F | 16   | 51-264.0252   | 34   | 51-373.022D   | 46   | 51-444.036DF | 15   |
| 10-2J09.1064 | 71   | 51-143.025D2F | 17   | 51-159.0250   | 40   | 51-271.022    | 34   | 51-373.022DF  | 20   | 51-445.036D  | 41   |
| 10-2J09.1065 | 71   | 51-144.025D2  | 43   | 51-159.0252   | 39   | 51-271.0252   | 34   | 51-374.022D   | 46   | 51-445.036DF | 15   |
| 10-2J09.1066 | 71   | 51-144.025D2F | 17   | 51-159.0254   | 39   | 51-272.0252   | 35   | 51-374.022DF  | 20   | 51-447.036DF | 15   |
| 10-2J09.1069 | 72   | 51-145.022D   | 41   | 51-159.0255   | 39   | 51-273.0252   | 35   | 51-375.022DF  | 20   | 51-448.036D  | 41   |
| 10-2J12.1062 | 71   | 51-145.022DF  | 15   | 51-159.0256   | 40   | 51-274.0252   | 35   | 51-376.022D   | 46   | 51-448.036DF | 15   |
| 10-2J12.1064 | 71   | 51-145.025D2  | 41   | 51-159.0258   | 40   | 51-281.022    | 33   | 51-376.022DF  | 20   | 51-451.036   | 33   |
| 10-2J12.1065 | 71   | 51-145.025D2F | 15   | 51-195.022D   | 42   | 51-281.022F   | 5    | 51-377.022D   | 46   | 51-451.036F  | 5    |
| 10-2J12.1066 | 71   | 51-146.025D2  | 41   | 51-195.022DF  | 16   | 51-281.022F   | 9    | 51-377.022DF  | 20   | 51-451.036F  | 9    |
| 10-2J12.1069 | 72   | 51-146.025D2F | 15   | 51-195.025D2  | 42   | 51-281.022F   | 11   | 51-378.022D   | 46   | 51-451.036F  | 11   |
| 10-2J13.1062 | 71   | 51-147.025D2F | 15   | 51-195.025D2F | 16   | 51-281.022F   | 13   | 51-378.022DF  | 20   | 51-451.036F  | 13   |
| 10-2J13.1064 | 71   | 51-148.025D2  | 41   | 51-196.025D2  | 42   | 51-281.0252   | 33   | 51-381.022D   | 45   | 51-452.036   | 33   |
| 10-2J13.1065 | 71   | 51-148.025D2F | 15   | 51-196.025D2F | 16   | 51-281.0252F  | 5    | 51-381.022DF  | 19   | 51-452.036F  | 5    |
| 10-2J13.1066 | 71   | 51-151.022    | 33   | 51-197.025D2  | 42   | 51-281.0252F  | 9    | 51-382.022D   | 45   | 51-452.036F  | 9    |
| 10-2J13.1069 | 72   | 51-151.022F   | 5    | 51-197.025D2F | 16   | 51-281.0252F  | 11   | 51-382.022DF  | 19   | 51-452.036F  | 11   |
| 10-2J19.1042 | 71   | 51-151.022F   | 9    | 51-198.025D2  | 42   | 51-281.0252F  | 13   | 51-383.022DF  | 19   | 51-452.036F  | 13   |
| 10-2J19.1044 | 71   | 51-151.022F   | 11   | 51-198.025D2F | 16   | 51-282.0252   | 33   | 51-384.022D   | 45   | 51-453.036   | 33   |
| 10-2J19.1045 | 71   | 51-151.022F   | 13   | 51-235.022D   | 43   | 51-282.0252F  | 5    | 51-384.022DF  | 19   | 51-453.036F  | 5    |
| 10-2J19.1046 | 71   | 51-151.0252   | 33   | 51-235.022DF  | 17   | 51-282.0252F  | 9    | 51-385.022D   | 45   | 51-453.036F  | 9    |
| 10-2J19.1049 | 72   | 51-151.0252F  | 5    | 51-235.025D2  | 43   | 51-282.0252F  | 11   | 51-385.022DF  | 19   | 51-453.036F  | 11   |
| 10-2J19.1049 | 72   | 51-151.0252F  | 9    | 51-235.025D2F | 17   | 51-282.0252F  | 13   | 51-386.022DF  | 19   | 51-453.036F  | 13   |
| 10-A312.314A | 72   | 51-151.0252F  | 11   | 51-236.025D2  | 43   | 51-283.0252   | 34   | 51-387.022DF  | 19   | 51-455.036   | 33   |
| 31-928       | 70   | 51-151.0252F  | 13   | 51-236.025D2F | 17   | 51-283.0252F  | 5    | 51-388.022D   | 45   | 51-455.036F  | 5    |
| 31-929       | 70   | 51-152.0252   | 33   | 51-237.025D2  | 43   | 51-283.0252F  | 9    | 51-388.022DF  | 19   | 51-455.036F  | 9    |
| 31-940       | 68   | 51-152.0252F  | 5    | 51-237.025D2F | 17   | 51-283.0252F  | 11   | 51-395.022D   | 42   | 51-455.036F  | 11   |
| 31-941       | 68   | 51-152.0252F  | 9    | 51-238.025D2  | 43   | 51-283.0252F  | 13   | 51-395.022DF  | 16   | 51-455.036F  | 13   |
| 31-942       | 68   | 51-152.0252F  | 11   | 51-238.025D2F | 17   | 51-284.0252   | 34   | 51-395.025D2  | 42   | 51-456.036F  | 5    |
| 31-945       | 69   | 51-152.0252F  | 13   | 51-252.026    | 37   | 51-284.0252F  | 5    | 51-395.025D2F | 16   | 51-456.036F  | 9    |
| 31-946       | 69   | 51-152.0260   | 40   | 51-252.0260   | 38   | 51-284.0252F  | 9    | 51-396.025D2  | 42   | 51-456.036F  | 11   |
| 31-985.0     | 67   | 51-152.0262   | 39   | 51-252.0264   | 37   | 51-284.0252F  | 11   | 51-396.025D2F | 16   | 51-456.036F  | 13   |
| 31-989.300   | 66   | 51-152.0264   | 39   | 51-252.0265   | 37   | 51-284.0252F  | 13   | 51-397.025D2  | 42   | 51-457.036D  | 41   |
| 31-989.311   | 67   | 51-152.0265   | 39   | 51-252.0266   | 38   | 51-295.022D   | 42   | 51-397.025D2F | 16   | 51-457.036DF | 15   |
| 31-991       | 74   | 51-152.0266   | 40   | 51-252.0268   | 38   | 51-295.022DF  | 16   | 51-398.025D2F | 16   | 51-458.036D  | 41   |
| 51-030.002   | 32   | 51-152.0268   | 40   | 51-253.022    | 37   | 51-295.025D2  | 42   | 51-401.036D   | 42   | 51-458.036DF | 15   |
| 51-030.005   | 32   | 51-153.0220   | 40   | 51-253.0220   | 38   | 51-295.025D2F | 16   | 51-401.036DF  | 16   | 51-461.036   | 34   |
| 51-031.006   | 32   | 51-153.0222   | 39   | 51-253.0224   | 37   | 51-296.025D2  | 42   | 51-402.036D   | 42   | 51-463.036   | 34   |
| 51-040.002   | 31   | 51-153.0224   | 39   | 51-253.0225   | 37   | 51-296.025D2F | 16   | 51-402.036DF  | 16   | 51-465.036   | 34   |
| 51-040.005   | 31   | 51-153.0225   | 39   | 51-253.0226   | 38   | 51-297.025D2  | 42   | 51-404.036D   | 42   | 51-471.036   | 34   |
| 51-041.006   | 31   | 51-153.0226   | 40   | 51-253.0228   | 38   | 51-297.025D2F | 16   | 51-404.036DF  | 16   | 51-473.036   | 34   |
| 51-050.002   | 31   | 51-153.0228   | 40   | 51-253.026    | 37   | 51-298.025D2  | 42   | 51-405.036D   | 42   | 51-475.036   | 34   |
| 51-050.002F  | 4    | 51-153.0252   | 34   | 51-253.0260   | 38   | 51-298.025D2F | 16   | 51-405.036DF  | 16   | 51-481.036   | 33   |
| 51-050.002F  | 7    | 51-153.0252F  | 5    | 51-253.0264   | 37   | 51-335.022D   | 43   | 51-407.036D   | 42   | 51-481.036F  | 5    |
| 51-050.002F  | 8    | 51-153.0252F  | 9    | 51-253.0265   | 37   | 51-335.022DF  | 17   | 51-407.036DF  | 16   | 51-481.036F  | 9    |
| 51-050.005   | 31   | 51-153.0252F  | 11   | 51-253.0266   | 38   | 51-335.025D2  | 43   | 51-408.036D   | 42   | 51-481.036F  | 11   |
| 51-050.005F  | 4    | 51-153.0252F  | 13   | 51-253.0268   | 38   | 51-335.025D2F | 17   | 51-408.036DF  | 16   | 51-481.036F  | 13   |
| 51-050.005F  | 7    | 51-153.0260   | 40   | 51-255.022D   | 41   | 51-336.025D2  | 43   | 51-411.036D   | 43   | 51-482.036F  | 5    |
| 51-050.005F  | 8    | 51-153.0262   | 39   | 51-255.022DF  | 15   | 51-336.025D2F | 17   | 51-411.036DF  | 17   | 51-482.036F  | 9    |
| 51-051.006   | 31   | 51-153.0264   | 39   | 51-255.025D2  | 41   | 51-337.025D2F | 17   | 51-412.036D   | 43   | 51-482.036F  | 11   |

| Part No.      | Page | Part No.    | Page | Part No.    | Page | Part No.    | Page | Part No.   | Page |
|---------------|------|-------------|------|-------------|------|-------------|------|------------|------|
| 51-482.036F   | 13   | 51-910      | 74   | 52-272.0252 | 48   | 61-9028.60  | 58   | 61-9927.2  | 63   |
| 51-483.036    | 33   | 51-920      | 65   | 52-273.0252 | 22   | 61-9028.9   | 58   | 61-9930.0  | 60   |
| 51-483.036F   | 5    | 51-925      | 65   | 52-273.0252 | 25   | 61-9029.20  | 58   | 61-9930.0  | 62   |
| 51-483.036F   | 9    | 51-931.0    | 54   | 52-273.0252 | 48   | 61-9029.30  | 58   | 61-9930.4  | 60   |
| 51-483.036F   | 11   | 51-931.2    | 54   | 52-274.0252 | 22   | 61-9029.40  | 58   | 61-9930.4  | 62   |
| 51-483.036F   | 13   | 51-931.3    | 54   | 52-274.0252 | 25   | 61-9029.8   | 58   | 61-9931.0  | 60   |
| 51-485.036    | 33   | 51-931.4    | 54   | 52-274.0252 | 48   | 61-9029.9   | 58   | 61-9931.0  | 62   |
| 51-485.036F   | 5    | 51-931.5    | 54   | 52-431.036  | 21   | 61-9451.0   | 65   | 61-9931.4  | 60   |
| 51-485.036F   | 9    | 51-931.6    | 54   | 52-431.036  | 24   | 61-9452.0   | 65   | 61-9931.4  | 62   |
| 51-485.036F   | 11   | 51-931.8    | 54   | 52-431.036  | 47   | 61-9453.0   | 65   | 61-9932.0  | 62   |
| 51-485.036F   | 13   | 51-931.9    | 54   | 52-432.036  | 21   | 61-9593.0   | 57   | 61-9932.0  | 63   |
| 51-486.036    | 33   | 51-933.1    | 54   | 52-432.036  | 24   | 61-9593.2   | 57   | 61-9932.1  | 62   |
| 51-486.036F   | 5    | 51-933.2    | 54   | 52-432.036  | 47   | 61-9593.4   | 57   | 61-9932.1  | 63   |
| 51-486.036F   | 9    | 51-933.3    | 54   | 52-433.036  | 21   | 61-9593.5   | 57   | 61-9932.10 | 62   |
| 51-486.036F   | 11   | 51-933.4    | 54   | 52-433.036  | 24   | 61-9642.1   | 52   | 61-9932.10 | 63   |
| 51-486.036F   | 13   | 51-933.5    | 54   | 52-433.036  | 47   | 61-9642.2   | 52   | 61-9932.2  | 62   |
| 51-495.022D   | 42   | 51-933.6    | 54   | 52-435.036  | 21   | 61-9642.3   | 52   | 61-9932.2  | 63   |
| 51-495.022DF  | 16   | 51-933.7    | 54   | 52-435.036  | 24   | 61-9642.4   | 52   | 61-9932.4  | 62   |
| 51-495.025D2  | 42   | 51-935.2    | 54   | 52-435.036  | 47   | 61-9642.5   | 52   | 61-9932.4  | 63   |
| 51-495.025D2F | 16   | 51-935.4    | 54   | 52-436.036  | 21   | 61-9642.6   | 52   | 61-9932.5  | 62   |
| 51-496.025D2  | 42   | 51-935.5    | 54   | 52-436.036  | 24   | 61-9642.7   | 52   | 61-9932.5  | 63   |
| 51-496.025D2F | 16   | 51-935.7    | 54   | 52-436.036  | 47   | 61-9643.201 | 55   | 61-9932.6  | 62   |
| 51-497.025D2  | 42   | 51-938      | 75   | 52-471.036  | 21   | 61-9643.202 | 55   | 61-9932.6  | 63   |
| 51-497.025D2F | 16   | 51-943.0    | 69   | 52-471.036  | 24   | 61-9643.203 | 55   | 61-9933.0  | 60   |
| 51-498.025D2  | 42   | 51-943.1    | 69   | 52-471.036  | 47   | 61-9643.301 | 55   | 61-9933.0  | 61   |
| 51-498.025D2F | 16   | 51-947.0    | 66   | 52-472.036  | 21   | 61-9643.401 | 55   | 61-9933.1  | 60   |
| 51-701.006    | 31   | 51-948.0    | 66   | 52-472.036  | 24   | 61-9643.501 | 55   | 61-9933.1  | 61   |
| 51-702.006    | 31   | 51-949.0    | 66   | 52-472.036  | 47   | 61-9643.502 | 55   | 61-9933.10 | 60   |
| 51-703.006    | 31   | 51-951.0    | 53   | 52-473.036  | 21   | 61-9643.503 | 55   | 61-9933.10 | 61   |
| 51-704.006    | 31   | 51-951.2    | 53   | 52-473.036  | 24   | 61-9643.601 | 55   | 61-9933.2  | 60   |
| 51-705.0292   | 34   | 51-951.3    | 53   | 52-473.036  | 47   | 61-9643.602 | 55   | 61-9933.2  | 61   |
| 51-706.0292   | 34   | 51-951.4    | 53   | 52-475.036  | 21   | 61-9643.603 | 55   | 61-9933.4  | 60   |
| 51-707.0292   | 34   | 51-951.5    | 53   | 52-475.036  | 24   | 61-9643.701 | 55   | 61-9933.4  | 61   |
| 51-708.0292   | 34   | 51-951.6    | 53   | 52-475.036  | 47   | 61-9643.702 | 55   | 61-9933.5  | 60   |
| 51-710.0292   | 33   | 51-951.8    | 53   | 52-476.036  | 21   | 61-9643.703 | 55   | 61-9933.5  | 61   |
| 51-712.0292   | 33   | 51-951.9    | 53   | 52-476.036  | 24   | 61-9671.1   | 52   | 61-9933.6  | 60   |
| 51-714.0292   | 34   | 51-953.1    | 53   | 52-476.036  | 47   | 61-9671.2   | 52   | 61-9933.6  | 61   |
| 51-715.0292   | 34   | 51-953.2    | 53   | 52-571.022A | 27   | 61-9671.3   | 52   | 61-9934.8  | 61   |
| 51-716.0292   | 34   | 51-953.3    | 53   | 52-571.022A | 29   | 61-9671.4   | 52   | 61-9936.0  | 63   |
| 51-718.0292   | 33   | 51-953.4    | 53   | 52-571.022A | 50   | 61-9671.5   | 52   | 61-9980.0  | 59   |
| 51-719.0292   | 33   | 51-953.5    | 53   | 52-572.022A | 27   | 61-9671.6   | 52   | 704.968.0  | 59   |
| 51-720.0292   | 33   | 51-953.6    | 53   | 52-572.022A | 29   | 61-9671.7   | 52   | 704.968.1  | 59   |
| 51-741.006    | 32   | 51-953.7    | 53   | 52-572.022A | 50   | 61-9681.1   | 52   | 84-9103.7  | 63   |
| 51-742.006    | 32   | 51-954.2    | 53   | 52-573.022A | 27   | 61-9681.2   | 52   |            |      |
| 51-746.0292   | 34   | 51-954.3    | 53   | 52-573.022A | 29   | 61-9681.3   | 52   |            |      |
| 51-747.0292   | 34   | 51-954.4    | 53   | 52-573.022A | 50   | 61-9681.4   | 52   |            |      |
| 51-749.0292   | 34   | 51-954.5    | 53   | 52-574.022A | 27   | 61-9681.5   | 52   |            |      |
| 51-750.0292   | 34   | 51-954.6    | 53   | 52-574.022A | 29   | 61-9681.6   | 52   |            |      |
| 51-901.0      | 54   | 51-954.7    | 53   | 52-574.022A | 50   | 61-9681.7   | 52   |            |      |
| 51-901.2      | 54   | 51-955.2    | 53   | 52-743.0292 | 47   | 61-9707.7   | 55   |            |      |
| 51-901.3      | 54   | 51-955.4    | 53   | 52-744.0292 | 47   | 61-9730.0   | 74   |            |      |
| 51-901.4      | 54   | 51-955.5    | 53   | 52-745.0292 | 48   | 61-9740.0   | 75   |            |      |
| 51-901.5      | 54   | 51-955.7    | 53   | 52-746.0292 | 48   | 61-9771.0   | 52   |            |      |
| 51-901.6      | 54   | 51-991      | 74   | 52-747.0292 | 48   | 61-9771.8   | 52   |            |      |
| 51-901.8      | 54   | 52-131.022  | 21   | 52-748.0292 | 48   | 61-9771.9   | 52   |            |      |
| 51-901.9      | 54   | 52-131.022  | 24   | 52-749.0292 | 48   | 61-9781.0   | 52   |            |      |
| 51-903.1      | 53   | 52-131.022  | 47   | 52-750.0292 | 48   | 61-9781.9   | 52   |            |      |
| 51-903.2      | 53   | 52-131.0252 | 21   | 52-928.0    | 58   | 61-9841.0   | 56   |            |      |
| 51-903.3      | 53   | 52-131.0252 | 24   | 52-928.20   | 58   | 61-9841.0A  | 56   |            |      |
| 51-903.4      | 53   | 52-131.0252 | 47   | 52-928.30   | 58   | 61-9841.2   | 56   |            |      |
| 51-903.5      | 53   | 52-132.0252 | 21   | 52-928.40   | 58   | 61-9841.2A  | 56   |            |      |
| 51-903.6      | 53   | 52-132.0252 | 24   | 52-928.50   | 58   | 61-9841.4   | 56   |            |      |
| 51-903.7      | 53   | 52-132.0252 | 48   | 52-928.60   | 58   | 61-9841.4A  | 56   |            |      |
| 51-904.2      | 54   | 52-133.0252 | 21   | 52-928.9    | 58   | 61-9841.5   | 56   |            |      |
| 51-904.3      | 54   | 52-133.0252 | 24   | 52-929.20   | 58   | 61-9841.5A  | 56   |            |      |
| 51-904.4      | 54   | 52-133.0252 | 48   | 52-929.30   | 58   | 61-9841.6   | 56   |            |      |
| 51-904.5      | 54   | 52-134.0252 | 21   | 52-929.40   | 58   | 61-9841.6A  | 56   |            |      |
| 51-904.6      | 54   | 52-134.0252 | 24   | 52-929.50   | 58   | 61-9841.8   | 56   |            |      |
| 51-904.7      | 54   | 52-134.0252 | 48   | 52-929.60   | 58   | 61-9841.8A  | 56   |            |      |
| 51-905.2      | 54   | 52-271.022  | 21   | 52-929.8    | 58   | 61-9842.0   | 56   |            |      |
| 51-905.4      | 54   | 52-271.022  | 24   | 52-929.9    | 58   | 61-9842.2   | 56   |            |      |
| 51-905.5      | 54   | 52-271.022  | 48   | 52-950.0    | 57   | 61-9842.5   | 56   |            |      |
| 51-905.7      | 54   | 52-271.0252 | 21   | 52-952.0    | 57   | 61-9842.6   | 56   |            |      |
| 51-906.2      | 54   | 52-271.0252 | 24   | 61-9028.0   | 58   | 61-9842.8   | 56   |            |      |
| 51-906.4      | 54   | 52-271.0252 | 48   | 61-9028.20  | 58   | 61-9921.0   | 64   |            |      |
| 51-906.5      | 54   | 52-272.0252 | 22   | 61-9028.40  | 58   | 61-9922.0   | 64   |            |      |
| 51-906.7      | 54   | 52-272.0252 | 25   | 61-9028.50  | 58   | 61-9924.0   | 64   |            |      |





Компания «ЭлектроПласт» предлагает заключение долгосрочных отношений при поставках импортных электронных компонентов на взаимовыгодных условиях!

Наши преимущества:

- Оперативные поставки широкого спектра электронных компонентов отечественного и импортного производства напрямую от производителей и с крупнейших мировых складов;
- Поставка более 17-ти миллионов наименований электронных компонентов;
- Поставка сложных, дефицитных, либо снятых с производства позиций;
- Оперативные сроки поставки под заказ (от 5 рабочих дней);
- Экспресс доставка в любую точку России;
- Техническая поддержка проекта, помощь в подборе аналогов, поставка прототипов;
- Система менеджмента качества сертифицирована по Международному стандарту ISO 9001;
- Лицензия ФСБ на осуществление работ с использованием сведений, составляющих государственную тайну;
- Поставка специализированных компонентов (Xilinx, Altera, Analog Devices, Intersil, Interpoint, Microsemi, Aeroflex, Peregrine, Syfer, Eurofarad, Texas Instrument, Miteq, Cobham, E2V, MA-COM, Hittite, Mini-Circuits, General Dynamics и др.);

Помимо этого, одним из направлений компании «ЭлектроПласт» является направление «Источники питания». Мы предлагаем Вам помощь Конструкторского отдела:

- Подбор оптимального решения, техническое обоснование при выборе компонента;
- Подбор аналогов;
- Консультации по применению компонента;
- Поставка образцов и прототипов;
- Техническая поддержка проекта;
- Защита от снятия компонента с производства.



#### Как с нами связаться

**Телефон:** 8 (812) 309 58 32 (многоканальный)

**Факс:** 8 (812) 320-02-42

**Электронная почта:** [org@eplast1.ru](mailto:org@eplast1.ru)

**Адрес:** 198099, г. Санкт-Петербург, ул. Калинина, дом 2, корпус 4, литера А.