



SECTION 2

**SOLID STATE RELAYS (SSR)
2.5 TO 125 AMPERES**



SOLID STATE RELAYS

RELAY SERIES



SSRDIN

L.E.D. STATUS LAMP

L W H
4.015 x 1.180 x 4.527



6 (ASX)

L.E.D. STATUS LAMP

L W H
2.25 x 1.75 x 0.78



6 (DSX)

L.E.D. STATUS LAMP

L W H
2.25 x 1.75 x 0.78

FEATURES

- AC & DC INPUT
- AC OUTPUT
- 10 OR 25 AMP LOADS
- PHOTO ISOLATED, ZERO VOLTAGE SWITCHING
- 4000V rms ISOLATION INPUT TO OUTPUT
- INTERNAL RC (SNUBBER) NETWORK
- RFI SUPPRESSION
- INTEGRAL SAFETY COVER, AND HEATSINK.
- DIN RAIL MOUNTING

- AC INPUT
- AC OUTPUT
- UP TO 125 AMP LOADS
- PHOTO ISOLATED, ZERO VOLTAGE SWITCHING
- 4000V rms ISOLATION INPUT TO OUTPUT
- INTERNAL RC (SNUBBER) NETWORK
- RFI SUPPRESSION
- SAFETY COVER STANDARD

- DC INPUT
- AC OUTPUT
- UP TO 125 AMP LOADS
- PHOTO ISOLATED, ZERO VOLTAGE SWITCHING
- 4000V rms ISOLATION INPUT TO OUTPUT
- INTERNAL RC (SNUBBER) NETWORK
- RFI SUPPRESSION
- SAFETY COVER STANDARD

OUTPUT DATA

OUTPUT CONFIGURATION:

SPST-NO

SPST-NO

SPST-NO

LOAD VOLTAGE:
LOAD CURRENT MAX.:

280, 660 VAC
10 & 25 AMPS

280, 560 OR 660 VAC
10 TO 125 AMPS

280, 560 OR 660 VAC
10 TO 125 AMPS

OUTPUT DEVICE:
MINIMUM LOAD:

BACK TO BACK SCRS
50 TO 250 MILLIAMPS

BACK TO BACK SCRS
50 TO 500 MILLIAMPS

BACK TO BACK SCRS
50 TO 500 MILLIAMPS

INSULATION CHARACTERISTICS
DIELECTRIC STRENGTH:

4000 V rms

4000 V rms

4000 V rms

INPUT DATA

INPUT VOLTAGE RANGE:

90 TO 280 VAC, 3 TO 32 VDC

90 TO 280 VAC

3 TO 32 VDC

INPUT CURRENT:

16 mA TYPICAL

20 mA TYPICAL

16 mA TYPICAL

MUST TURN OFF VOLTAGE:

10 VAC OR 1 VDC

10 VAC

1 VDC

GENERAL DATA

AMBIENT TEMPERATURE
OPERATIONAL:
STORAGE:

- 30°C TO +80°C
- 40°C TO +100°C

- 40°C TO +80°C
- 40°C TO +100°C

- 40°C TO +80°C
- 40°C TO +100°C

RESPONSE TIME
OPERATE MAX.:
RELEASE MAX.:
INSULATION RESISTANCE:
TERMINALS:

AC: 40 mS, DC 10 mS
AC: 80 mS, DC 10 mS
10¹⁰ Ω
SCREW

40 mS
80 mS
10¹⁰ Ω
SCREW

40 mS
80 mS
10¹⁰ Ω
SCREW

AGENCY APPROVALS



UL Recognized
File No. E52197



UL Recognized
File No. E52197



CE APPROVED ON
SELECT MODELS



UL Recognized
File No. E52197



CE APPROVED ON
SELECT MODELS

PAGE NUMBER

PAGE 8

PAGE 9

PAGE 10

6 (DDX)



L.E.D. STATUS LAMP

6 (DTX)



L.E.D. STATUS LAMP

6 (DTX)



L.E.D. STATUS LAMP

L W H
2.25 x 1.75 x 0.78

L W H
2.25 x 1.75 x 0.78

L W H
2.25 x 1.75 x 0.78

- DC INPUT
- DC OUTPUT
- UP TO 40 AMP LOADS
- ISOLATED, 2500 V rms ISOLATION INPUT TO OUTPUT
- RFI SUPPRESSION
- SAFETY COVER STANDARD
- L.E.D. STATUS LAMP

- DC INPUT
- AC OUTPUT
- UP TO 40 AMP LOADS
- PHOTO ISOLATED ZERO VOLTAGE SWITCHING
- 4000 V rms ISOLATION INPUT TO OUTPUT
- INTERNAL RC (SNUBBER) NETWORK
- SAFETY COVER STANDARD

- DC INPUT
- AC TRIAC OUTPUT
- 10 AMP LOADS
- PHOTO ISOLATED ZERO VOLTAGE SWITCHING
- 4000V rms ISOLATION INPUT TO OUTPUT
- INTERNAL RC (SNUBBER) NETWORK
- RFI SUPPRESSION

SPST-NO

SPST-NO, SPST-NC

DPST-NO

200 VDC
12, 25 & 40 AMPS

280 OR 560 VAC
10, 25 OR 40 AMPS

280 VAC
10 AMPS

MOSFET
20 MILLIAMPS

TRIAC
50 TO 250 MILLIAMPS

TRIAC
50 MILLIAMPS

2500 V rms

4000 V rms

4000 V rms

3.5 TO 32 VDC
10 mA TYPICAL
1 VDC

3 TO 32 VDC
2 mA TYPICAL
1 VDC

3.5 TO 32 VDC
2 mA TYPICAL
1 VDC

- 40°C TO +80°C
- 40°C TO +100°C

- 40°C TO +80°C
- 40°C TO +100°C

- 40°C TO +80°C
- 40°C TO +100°C

600 uSec
2.6 mSec
10¹⁰ Ω
SCREW

40 mS
80 mS
10¹⁰ Ω
SCREW

40 mS
80 mS
10¹⁰ Ω
QUICK CONNECTS

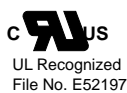

RELAY SERIES	70S2 "V" STYLE	70S2 "N" & "S" STYLES	70S2 "F" & "M" STYLES
FEATURES	<ul style="list-style-type: none"> ● DC INPUT ● AC OR DC OUTPUT ● 3 AMP LOADS ● OPTICALLY ISOLATED ● SINGLE IN-LINE PACKAGE 	<ul style="list-style-type: none"> ● DC INPUT ● AC OR DC OUTPUT ● UP TO 25 AMP LOADS ● OPTICALLY ISOLATED ● COMPACT SIZE 	<ul style="list-style-type: none"> ● DC INPUT ● AC OR DC OUTPUT ● UP TO 10 AMP LOADS ● OPTICALLY ISOLATED ● PRINTED CIRCUIT TERM OR PANEL MOUNT
	<p>FORMERLY GRAYHILL</p>	<p>FORMERLY GRAYHILL</p>	<p>FORMERLY GRAYHILL</p>
OUTPUT DATA OUTPUT CONFIGURATION:	<p>SPST-NO</p>	<p>SPST-NO</p>	<p>SPST-NO</p>
LOAD VOLTAGE: LOAD CURRENT MAX.:	<p>50, 140, 280 VAC, 60 VDC 3 AMPS</p>	<p>140 OR 280 VAC, 60 VDC 6, 12 OR 25 AMPS</p>	<p>140 OR 280 VAC OR 60 VDC 3, 4, 6 & 10 AMPS</p>
OUTPUT DEVICE: MINIMUM LOAD:	<p>TRIAC (AC) OR TRANSISTOR (DC) 65 MILLIAMPS</p>	<p>TRIAC (AC) OR TRANSISTOR (DC) 65 MILLIAMPS</p>	<p>TRIAC (AC) OR TRANSISTOR (DC) 65 MILLIAMPS</p>
INSULATION CHARACTERISTICS DIELECTRIC STRENGTH:	<p>2500 V rms</p>	<p>2500 V rms</p>	<p>2500 V rms</p>
INPUT DATA INPUT VOLTAGE RANGE: INPUT CURRENT: MUST TURN OFF VOLTAGE:	<p>3 TO 32 VDC 1.0 TO 19 mA TYPICAL 1 VDC</p>	<p>3 TO 30 VDC 1.0 TO 19 mA TYPICAL 1 VDC</p>	<p>3 TO 30 VDC 1.0 TO 16 mA TYPICAL 1 VDC</p>
GENERAL DATA AMBIENT TEMPERATURE OPERATIONAL: STORAGE: RESPONSE TIME OPERATE MAX.: RELEASE MAX.: INSULATION RESISTANCE: TERMINALS:	<p>- 40°C TO +100°C - 40°C TO +125°C 8.3 mS 8.3 mS 10¹⁰ Ω PRINTED CIRCUIT</p>	<p>- 40°C TO +100°C - 40°C TO +125°C 8.3 mS 8.3 mS 10¹⁰ Ω QUICK CONNECTS OR SCREW</p>	<p>- 40°C TO +100°C - 40°C TO +125°C 8.3 mS 8.3 mS 10¹⁰ Ω PRINTED CIRCUIT</p>
AGENCY APPROVALS			

70S2 "H" & "L" STYLES



L W H
1.20 x 1.00 x 0.520

- DC INPUT
- AC OUTPUT
- UP TO 6 AMP LOADS
- OPTICALLY ISOLATED
- PRINTED CIRCUIT TERMINAL OR PANEL MOUNT

FORMERLY GRAYHILL

SPST-NO

140 OR 280 VAC
2.5 OR 6 AMPS

TRIAC (AC) OR TRANSISTOR (DC)
65 MILLIAMPS

2500 V rms

3 TO 30 VDC
1.0 TO 18 mA TYPICAL
1 VDC

- 40°C TO +100°C
- 40°C TO +125°C

8.3 mS
8.3 mS
10¹⁰ Ω
PRINTED CIRCUIT



70S2 "K" STYLE



L W H
1.20 x 1.00 x 0.830

- DC INPUT
- AC OUTPUT
- UP TO 6 AMP LOADS
- OPTICALLY ISOLATED
- QUICK CONNECT TERMINAL OR PANEL MOUNT

FORMERLY GRAYHILL

SPST-NO

140 OR 280 VAC
4 AMPS

TRIAC (AC) OR TRANSISTOR (DC)
65 MILLIAMPS

3000 V rms

3 TO 30 VDC
1.0 TO 18 mA TYPICAL
1 VDC

- 40°C TO +100°C
- 40°C TO +125°C

8.3 mS
8.3 mS
10¹⁰ Ω
PRINTED CIRCUIT



226



L W H
1.50 X 0.670 X 0.600

- DC INPUT
- AC OUTPUT
- UP TO 7 AMP LOADS
- PHOTO ISOLATED
- RANDOM TURN-ON
- COMPATABLE WITH TTL GATES
- MOUNTS ON TO -3 TRANSISTOR HEAT SINKS

SPST-NO

140 OR 280 VAC
7 AMPS

TRIAC
50 MILLIAMPS

2500 V rms

5 & 12 VDC
10 mA TYPICAL
1.4 VDC

- 30°C TO +80°C
- 40°C TO +100°C

10 mS
60 mS
10¹⁰ Ω
PRINTED CIRCUIT OR PUSH ON



APPLICATION DATA

INTRODUCTION:

SOLID STATE RELAY (SSR) is a relay with isolated input and output, whose functions are achieved by means of electronic components without the use of moving parts as found in electromechanical relays.

PRINCIPLE OF OPERATION:

Solid State Relays are similar to electromechanical relays, in that both use a control circuit and a separate circuit for switching the load. When voltage is applied to the input of the SSR, the relay is energized by a light emitting diode. The light from the diode is beamed into a light sensitive semiconductor which, in the case of zero voltage crossover relays, conditions the control circuit to turn on the output solid state switch at the next zero voltage crossover. In the case of nonzero voltage crossover relays, the output solid state switch is turned on at the precise voltage occurring at the time. Removal of the input power disables the control circuit and the solid state switch is turned off when the load current passes through the zero point of its cycle.

APPLICATIONS:

Solid State Relays are specially suitable in many applications. Listed below are some typical applications.

INDUSTRIAL AUTOMATION



ALARM SYSTEMS



ELECTRONIC APPLIANCES



INDUSTRIAL APPLIANCES



MEDICAL EQUIPMENT



PACKING MACHINES



TOOLING MACHINGS



APPLICATION AND SELECTION CRITERIA FOR SOLID STATE RELAYS:

The Chart below indicates the areas in which SSR's (Solid State Relays) or EMR's (Electromechanical Relays) have better capabilities. (X) Indicates the Better choice.

	SSR	EMR
Long life	X	
Temperature cycling		X
Shock and vibration resistant	X	
Immunity to false operation due to transients		X
Generation of RFI, EMI	X	
Multipole		X
Multithrow (SPDT)		X
Size (includes Heat Sink) for equivalent load handling		X
Contact bounce	X	
Arcless switching	X	
Acoustic noise	X	
Zero voltage switching	X	
Ease of diagnosing malfunction		X
IC compatibility	X	
Immunity to humidity, salt spray & dirt	X	

LOAD CONSIDERATIONS

A major portion of application problems with SSR's result from operating conditions which specific loads impose upon an SSR. The following types of loads point out the potential problems that can occur with SSR's.

DC LOADS: All loads should be considered inductive and a diode should be placed across the load to absorb any inductive surge on turnoff.

RESISTIVE LOADS: Loads of constant value resistance are probably the simplest application of SSR's. Proper attention to the steady state current ratings and applied blocking voltage specifications normally will result in trouble-free operation.

LAMP LOADS: Incandescent lamp loads, though basically resistive, present some special problems. Because the resistance of a cold tungsten filament is about five to ten percent of the heated value, a large inrush current can occur. The period of the inrush current can range from one half cycle to several cycles, depending on the thermal time constant of the filament. It is essential to verify that this inrush current is within the surge specifications of the SSR. Also check that the lamp rating of the SSR is not exceeded. This is a UL rating based on the inrush of a typical lamp. Because of the unusually low filament resistance at the time of turn-on, a zero voltage turn-on characteristic is particularly desirable with tungsten lamps. It has been demonstrated that a zero voltage turn-on can extend the life of tungsten lamps by limiting inrush current.

CAPACITIVE LOADS: Caution must be used with low impedance capacitive loads to verify that the di/dt capabilities are not exceeded. The di/dt of a discharged capacitive load without external limiting impedance can approach infinity. Zero voltage turn-on is a particularly valuable means of limiting di/dt with capacitive loads.

MOTORS: Motors frequently have severe inrush currents during starting and can impose unusual voltages during turnoff. The inrush currents connected to mechanical loads having high starting torque or inertia should be carefully determined to verify that they are within the surge capabilities of the SSR. A current shunt and oscilloscope should be used to examine the duration of the inrush current. Motor starting may frequently reoccur at short intervals and the affect of repetitive inrush currents on the thermal operating point of an SSR must be considered. Check the motor operating current and locked rotor current versus the SSR motor rating. The possibility of abnormally stalled rotor conditions which draw much higher than normal currents should be considered. An extended stalled rotor condition may require an oversized SSR or fuse protection. The generated EMF of certain motors can require an SSR to have a blocking voltage greater than might be expected from steady state line voltage. The voltage applied to an SSR by a motor circuit during turnoff should be examined with an oscilloscope to verify that the applied voltages are safely below the specified SSR blocking voltages. Otherwise lock-on or erratic turnoff of the motor may occur. Some motor circuits may require higher than normal blocking voltage, transient limiting devices, or other techniques to control the voltage which must be blocked by an SSR during deceleration or direction reversal.

TRANSFORMERS:

In controlling transformers, the characteristics of the secondary load should be considered because it reflects the effective load on the SSR. Voltage transients from secondary load circuits, similarly, are frequently transformed and can be imposed on the SSR. Transformers present a special problem in that, depending on the state of the transformer flux at the time of turnoff, the transformer may saturate during the first half-cycle of subsequent applied voltage. This saturation can impose a very large current (Commonly ten to one hundred times rated primary current) on the SSR and exceed its half-cycle surge rating.

SSR's having random turn-on may have a better chance of survival than a zero voltage turn-on device for they commonly require the transformer to support only a

portion of the first half-cycle of the voltage. On the other hand, a random turn-on device will frequently close at the essentially zero voltage point (start of the half-cycle) and then the SSR must sustain the worst-case saturation current. A zero voltage turn-on device has the advantage that it turns on in a known, predictable mode and will normally immediately demonstrate (dependent on turnoff flux polarity) the worst-case condition. The use of an oscilloscope is recommended to verify that the half-cycle surge capability of the SSR is not exceeded. The severity of the transformer saturation problem varies greatly, dependent on the magnetic material of the transformer, saturated primary impedance, line impedance, etc.

A safe rule of thumb in applying an SSR to a transformer primary is to select an SSR having a half-cycle current surge rating (RMS) greater than the maximum applied line voltage (RMS) divided by the transformer primary resistance. The primary resistance is usually easily measured and can be relied on as a minimum impedance limiting the first half-cycle of inrush current. The presence of some residual flux plus the saturated reactance of the primary will then further limit, in the worst case, the half-cycle surge safely within the surge rating of the SSR.

SELECTING THE PROPER SSR

NOMINAL LOAD CURRENT: Initially select a relay whose current rating exceeds the normal load current. Using the load current vs, temperature charts for that relay, check the actual current capacity at the ambient temperature to which the relay will be subjected.

As an example, the chart shows that a 25 ampere relay provided with a suitable heat sink can safely carry a maximum of 22 amperes continuously

at 40°C ambient. Since heat degrades the components ability to carry current, every effort should be made to keep the operating temperature of the SSR as low as possible.

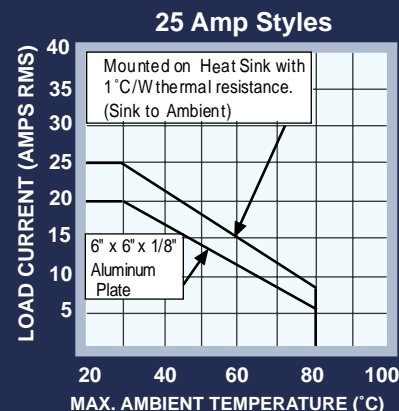

APPLICATION DATA

PROTECTING THE OUTPUT SWITCH:

An SCR is a four layer semiconductor having 3 terminals: Cathode, anode and Gate. Normally it blocks current in both the forward and reverse directions. The SCR is triggered on in the forward direction by a small gate current. The SCR remains on until load current decreases to a value less than necessary to maintain the SCR in the on state. When switching AC, two SCRS are connected in inverse parallel.

A Triac also has 3 terminals, like the SCR, it normally blocks current in both directions; but may be triggered in either direction by a small gate current

Both SCR's and Triacs are members of the thyristor family. Therefore, we use this term to denote both devices.

There are 4 ways to put a thyristor into a conducting mode. Only one method is desirable and the other three are the source of most application problems.

The 4 methods of Thyristor turn-on are -

- A. Gate Turn-on: By injecting a controlled current into the gate (the desired method).
- B. Forward Breakover Turn-on: A voltage in excess of the Breakover (or Peak Blocking) voltage across thyristor.
- C. DV/DT turn-on: A voltage which rises faster than the Thyristor can tolerate, and still remain in the off state.
- D. Thermal Turn-on: Allowing the temperature of the thyristor to go beyond the value sufficient to cause excessive leakage current, causing turn-on and possible thermal runaway.

The last three methods can be protected against as follows. In those situations where high peak voltage transients occur, effective protection can be obtained by using metal oxide varistors (MOV). The MOV is a bidirectional voltage sensitive device that has low impedance when its design voltage threshold is exceeded.

HEAT SINKING:

It is important to select the right size heat sink for your applications. SSR's will typically generate 1.2 watts per amp of load current. The total wattage times the thermal resistance equal the temperature. For example a 25 amps SSR with a 20 amps load applied dissipates 24 watts when mounted on a aluminum plate 6" X 6" X 1/8" with thermal grease applied between the SSR base and aluminum plate. 20 amps x 1.2 watts / amp = 24 watts. 24 watts x 1°C / watts = 24°C rise.

FUSING:

The SSR has a I² T rating which is a measure of the amount of energy it can safely handle without damage. The I² T rating of the fuse is a measure of the amount of energy the fuse will pass to the SSR. To protect the SSR, an inline fuse rating should be less than that of the SSR. An SSR exposed to a surge greater than its non-repetitive rating will normally fail as a shorted unit.

EXPRESSIONS USED IN SPECIFICATIONS

$\frac{dv}{dt}$	Equals the maximum permissible rate of change of voltage in volts/microseconds
V =	Line Voltage
I =	Load Current
PF =	Load Power Factor
F =	Line Frequency
L =	Inductance in Henrys
C =	Capacitance in Microfarads
$R_1 \& R_2$ =	Resistance in Ohms



SOLID STATE RELAY SELECTION CHART

CONTROL VOLTAGE	LOAD VOLTAGE	MOUNTING	LOAD CURRENT AMPS												PAGE	
			2	3	4	5	6	10	12	25	40	50	75	90		125
3 - 30VDC	240 VAC or 60 VDC	PC BOARD	H PACK	[Bar chart showing current range]											21 - 22	
			L PACK	[Bar chart showing current range]											21 - 22	
		PC BOARD (SIP)	F PACK	[Bar chart showing current range]											19 - 20	
			V PACK	[Bar chart showing current range]											16	
		PANEL	K PACK	[Bar chart showing current range]											23 - 24	
			M PACK	[Bar chart showing current range]											19 - 20	
			N PACK	[Bar chart showing current range]											17 - 18	
			S PACK	[Bar chart showing current range]											17 - 18	
		200 VDC 600 VAC 480 VAC	PANEL	W6 series (DDX)	[Bar chart showing current range]											12
				W6 series (DSX)	[Bar chart showing current range]											11
W6 series (DTX)	[Bar chart showing current range]											13 - 14				
DIN/PANEL	SSR-DIN-DC		[Bar chart showing current range]											8		
	SSR-DIN-AC		[Bar chart showing current range]											8		
	W6 series (ASX)		[Bar chart showing current range]											10		
90 - 280VAC	5 or 12 VDC	PC/PUSH ON TERM.	W226	[Bar chart showing current range]											25	

SPST-N.O., 10 & 25 AMPS

- AC & DC CONTROLLED INPUT
- INTEGRAL HEATSINK ONLY
- 30 MILLIMETERS WIDE
- PANEL/DIN MOUNTABLE (35 mm RAIL)
- FINGER SAFE COVER
- L. E. D. STATUS LAMP.

OUTLINE DIMENSIONS
DIMENSIONS SHOWN IN INCHES & (MILLIMETERS).

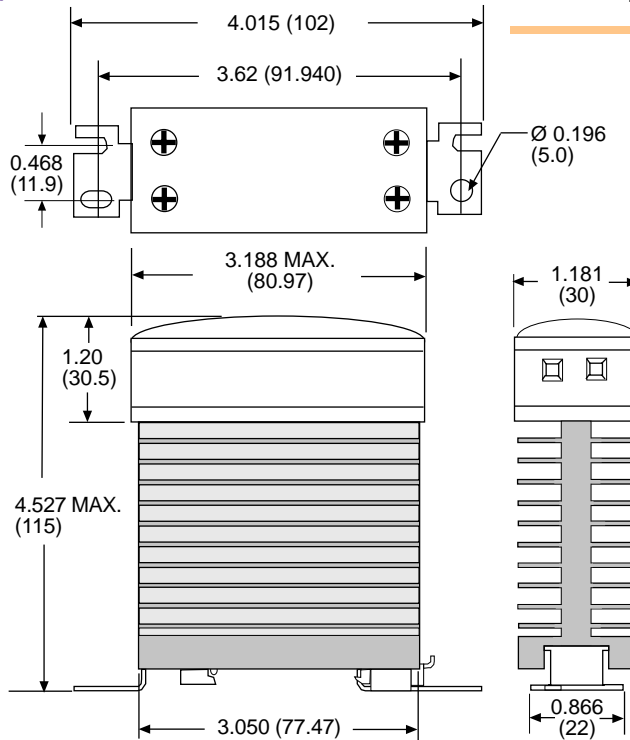

UL US
UL Recognized
File No. E52197

RED L.E.D. STATUS LAMP



RECOMMEND SPACING BETWEEN MULTIPLE SSR'S 0.75 INCH

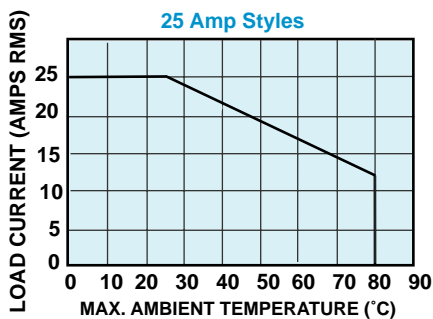
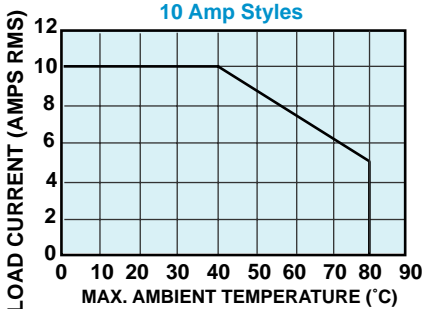

GENERAL SPECIFICATIONS

INPUT CHARACTERISTICS

Control Voltage Range:	DIN-AC: 90-280 VAC / DIN-DC: 3 - 32 VDC
Typical Input Current:	AC: 12 mA; DC: 16 mA
Must Release Voltage:	10 VAC / 1 VDC
Reverse Polarity Protection:	DC: Yes
Power Indicator:	Red L. E. D. Status lamp

OUTPUT CHARACTERISTICS

Style:	SSR: 210DIN-AC	225DIN-AC	610DIN-AC	625DIN-AC	210DIN-DC	225DIN-DC	610DIN-DC	625DIN-DC
Load Voltage Range:	24-280 VAC	24-280 VAC	48-660 VAC	48-660 VAC	24-280 VAC	24-280 VAC	48-660 VAC	48-660 VAC
Rated Load Current:	10 Amp	25 Amp	10 Amp	25 Amp	10 Amp	25 Amp	10 Amp	25 Amp
Maximum Off-State Voltage dv/dt:	200 uS	500 uS	200 uS	700 uS	200 uS	500 uS	200 uS	700 uS
Minimum Load Current:	50 mA	120 mA	80 mA	250 mA	50 mA	120 mA	80 mA	250 mA
Non -Repetitive Surge Current (1 Cycle):	83 A	800 A	83 A	1000 A	83 A	800 A	83 A	1000 A
Maximum Off State Leakage current (Rms):	10 mA	10 mA	10 mA	10 mA	10 mA	10 mA	10 mA	10 mA
Typical On-State Voltage Drop (Rms):	1.25 VAC	1.35 VAC	1.25 VAC	1.35VAC	1.25 VAC	1.25 VAC	1.25VAC	1.35 VAC
Maximum I ² T For Fusing (A ² Sec):	83	3700	83	1700	83	3700	83	1700

Operating Frequency Range:	25 Hz to 70 Hz
Maximum Turn - On Time:	AC: 40 mS / DC: 10 mS
Maximum Turn - Off Time:	AC: 80 mS / DC: 10 mS

MISCELLANEOUS CHARACTERISTICS

Dielectric Strength (Input-to Output Isolation):	4000 V rms
Insulation Resistance:	10 ¹⁰ Ω
Operating Temperature Range:	-30°C to +80°C
Storage Temperature Range:	-40°C to +100°C
Weight:	340 grams approx.

PART NUMBERS	RATED LOAD CURRENT
--------------	--------------------

SSR210DIN-AC	10 AMPS
SSR225DIN-AC	25 AMPS
SSR610DIN-AC	10 AMPS
SSR625DIN-AC	25 AMPS
SSR210DIN-DC	10 AMPS
SSR225DIN-DC	25 AMPS
SSR610DIN-DC	10 AMPS
SSR625DIN-DC	25 AMPS

SPST-N.O. 10 TO 125 AMPS

UL **US** **CE**
 UL Recognized On selected
 File No. E52197 models

OUTLINE DIMENSIONS
 DIMENSIONS SHOWN IN INCHES & (MILLIMETERS).

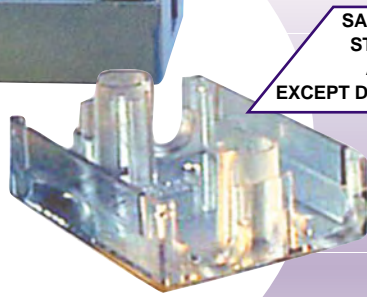
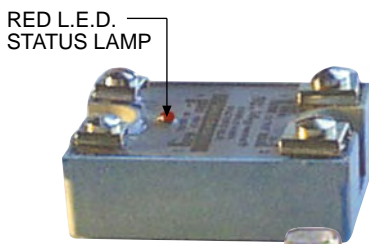
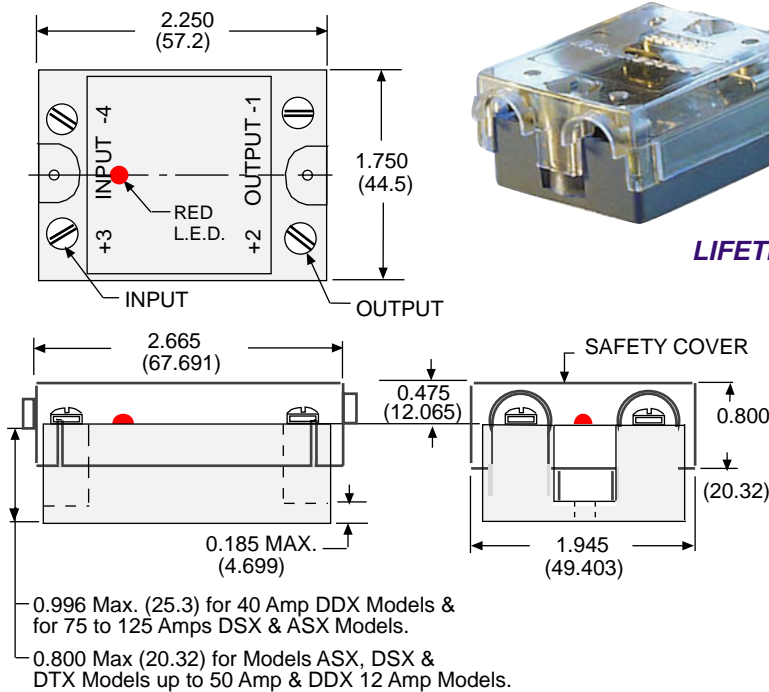

LIFETIME WARRANTY

INPUT & OUTPUT SCREW SIZE

UP TO 40 AMP	
INPUT	OUTPUT
M 3.5	M 4
ABOVE 40 AMP	
M 3.5	M 6

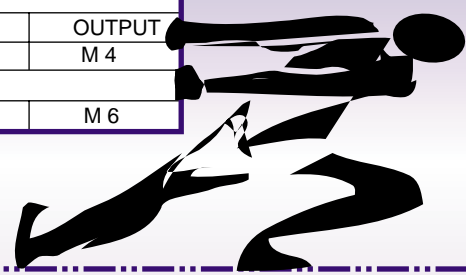

THERMAL DERATING CURVE & LOAD CHARACTERISTICS

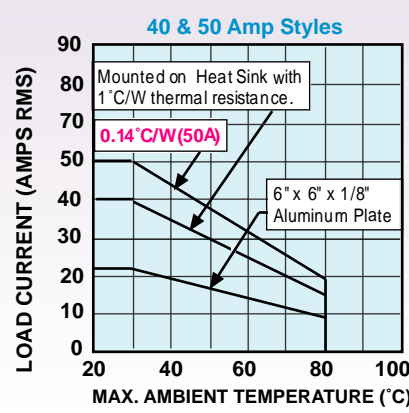
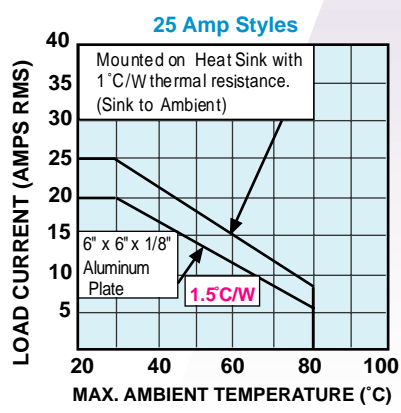
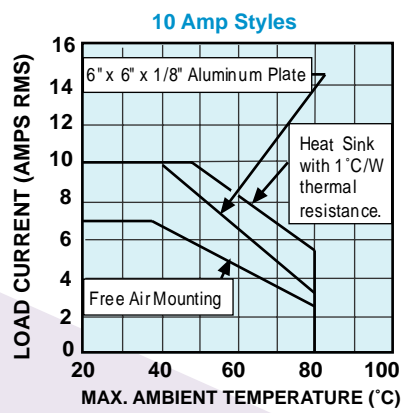

ORDERING CODE FOR RELAYS

W 6 2 10 ASX-

DENOTES STOCK: _____

CLASS: _____

LOAD VOLTAGE RANGE:
 24 - 280 VAC: **CODE 2**
 48 - 560 VAC: **CODE 4**
 48 - 600 VAC: **CODE 6**

RATED LOAD CURRENT:
 10 AMPS, 25 AMPS,
 40 AMPS, 50 AMPS,
 75 AMPS, 90 AMPS,
 125 AMPS

INPUT/OUTPUT STYLE: _____
 AC INPUT / AC OUTPUT - ASX (SCR)
 DC INPUT / AC OUTPUT - DSX (SCR)
 DC INPUT / AC OUTPUT - DTX (TRIAC)
 DC INPUT / DC OUTPUT - DDX (MOSFET)

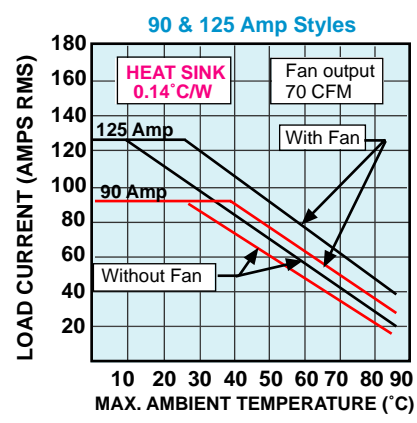
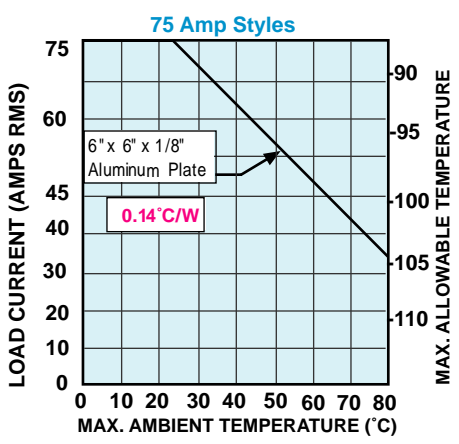

ALL CURRENT RATINGS ON THE FOLLOWING PAGES ARE BASED ON USE OF A SUITABLE THERMALLY CONDUCTIVE COMPOUND (E.G. SILICONE GREASE BETWEEN THE SSR MOUNTING BASE AND THE MOUNTING SURFACE OF A SUITABLE HEAT SINK).

ASX SERIES SPST-N.O. 10 TO 125 AMPS

AC CONTROLLED INPUT
AC SCR OUTPUT.
L. E. D. STATUS LAMP

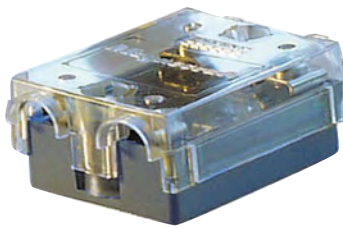

cRU us
UL Recognized
File No. E52197

CE On selected models

GENERAL SPECIFICATIONS

INPUT CHARACTERISTICS

Control Voltage Range: 90 - 280 VAC
 Typical Input Current: 20 mA
 Must Release Voltage: 10 VAC
 Power Indicator: Red L. E. D. Status lamp

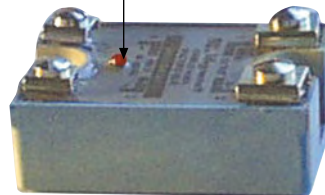

COMPLIES WITH REQUIREMENTS OF
 * IEC STANDARDS 947-4-1 AND 947-5-1 LOW VOLTAGE DIRECTIVE
 * IEC = INTERNATIONAL ELECTROTECHNICAL COMMISSION
 * CE TESTING AND EVALUATION PERFORMED BY THE UNDERWRITERS LABORATORIES AS A THIRD PARTY PARTICIPANT

OUTPUT CHARACTERISTICS

Style: W62, W64, W66
 Load Voltage Range: 40 - 280 VAC, 48 - 560 VAC, 48 - 660 VAC
 Rated Load Current: 10 Amp, 25 Amp, 40 Amp, 50 Amp, 75 Amp, 90 Amp, 125 Amp
 Maximum Off-State Voltage dv/dt: 200 uS, 500 uS, 500 uS, 500 uS, 500 uS, 200 uS, 300 uS, 500 uS, 500 uS, 500 uS, 1000 uS, 1000 uS
 Minimum Load Current: 50 mA, 120 mA, 250 mA, 250 mA, 250 mA, 50 mA, 120 mA, 250 mA, 250 mA, 250 mA, 500 mA, 500 mA
 Non -Repetitive Surge Current (1 Cycle): 83 A, 250 A, 625 A, 520 A, 1150 A, 83 A, 250 A, 625 A, 520 A, 1150 A, 1350 A, 1800 A
 Maximum off State Leakage current (Rms): 8 mA, 8 mA, 10 mA, 10 mA, 10 mA, 10 mA, 8 mA, 10 mA, 10 mA, 10 mA, 5 mA, 5 mA
 Typical On-State Voltage Drop (Rms): 1.6 VAC, 1.6 VAC, -, 1.8 VAC, 1.8 VAC, 1.6 VAC, 1.6 VAC, 1.6 VAC, 1.8VAC, 1.8 VAC, 1.8 VAC, 1.8 VAC
 Maximum I²T for Fusing (A² Sec): 72, 312, 1250, 1250, 5000, 72, 312, 1250, 1035, 2600, 3500, 5800
 Suggested Heatsink °C/W: 3.2, 0.5, 0.2, 0.14, 0.14, 3.2, 0.5, 0.2, 0.14, 0.14, 0.14+fan, 0.14+fan
 Operating Frequency Range: 25 Hz to 70 Hz
 Maximum Turn - On Time: 40 mS
 Maximum Turn - Off Time: 80 mS

W62					W64					W66	
40 - 280 VAC					48 - 560 VAC					48 - 660 VAC	
10 Amp	25 Amp	40 Amp	50 Amp	75 Amp	10 Amp	25 Amp	40 Amp	50 Amp	75 Amp	90 Amp	125 Amp
200 uS	500 uS	500 uS	500 uS	500 uS	200 uS	300 uS	500 uS	500 uS	500 uS	1000 uS	1000 uS
50 mA	120 mA	250 mA	250 mA	250 mA	50 mA	120 mA	250 mA	250 mA	250 mA	500 mA	500 mA
83 A	250 A	625 A	520 A	1150 A	83 A	250 A	625 A	520 A	1150 A	1350 A	1800 A
8 mA	8 mA	10 mA	10 mA	10 mA	10 mA	8 mA	10 mA	10 mA	10 mA	5 mA	5 mA
1.6 VAC	1.6 VAC	-	1.8 VAC	1.8 VAC	1.6 VAC	1.6 VAC	1.6 VAC	1.8VAC	1.8 VAC	1.8 VAC	1.8 VAC
72	312	1250	1250	5000	72	312	1250	1035	2600	3500	5800
3.2	0.5	0.2	0.14	0.14	3.2	0.5	0.2	0.14	0.14	0.14+fan	0.14+fan

MISCELLANEOUS CHARACTERISTICS

Dielectric Strength (Input-to Output Isolation): 4000 V rms
 Insulation Resistance: 10¹⁰ Ω min.
 Operating Temperature Range: -40°C to +80°C
 Storage Temperature Range: -40°C to +100°C
 Weight: 10 amps to 50 amps: 100 grams approx.
 75 amps to 125 amps: 250 grams approx.

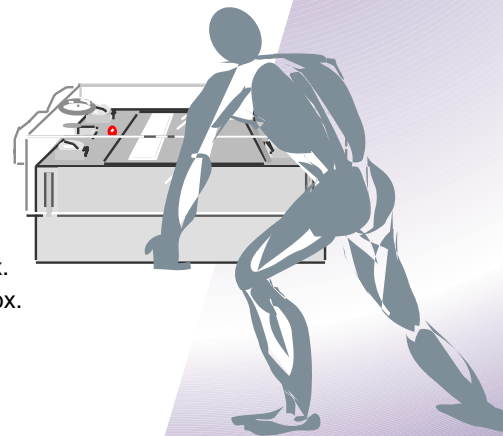

FEATURES

- * RED L. E. D. STATUS LAMP
- * CLEAR SAFETY COVER
- * UP TO 660 VAC OUTPUTS
- * HIGH TRANSIENT CAPABILITY— SINGLE OUTPUT FEATURES BACK TO BACK SCR'S AND INTERNALLY MOUNTED RC (SNUBBER) NETWORK FOR HIGH DV/DT APPLICATIONS.
- * PHOTO-ISOLATED, ZERO VOLTAGE SWITCHING
- * OPTICALLY COUPLED FOR 4000 VAC ISOLATION BETWEEN INPUT AND OUTPUT AND RFI SUPPRESSION.
- * LIFETIME WARRANTY

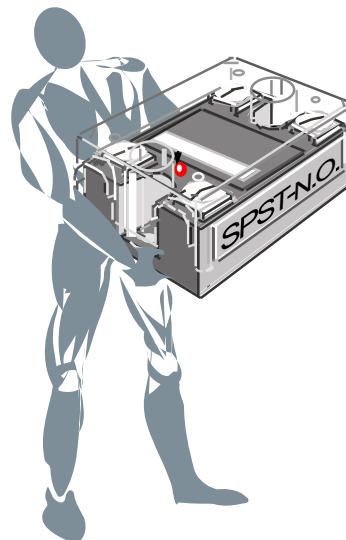

PART NUMBERS	RATED LOAD CURRENT
W6210ASX-1	10 AMPS
*W6225ASX-1	25 AMPS
W6240ASX-1	40 AMPS
W6250ASX-1	50 AMPS
W6275ASX-1	75 AMPS
W6410ASX-1	10 AMPS
W6425ASX-1	25 AMPS
W6440ASX-1	40 AMPS
W6450ASX-1	50 AMPS
W6475ASX-1	75 AMPS
W6690ASX-1	90 AMPS
W66125ASX-1	125 AMPS

* **CE** Approved

SEE END OF SECTION 2 FOR CROSS REFERENCE.

DSX SERIES SPST-N.O. 10 TO 125 AMPS

DC CONTROLLED INPUT
AC SCR OUTPUT
L. E. D. STATUS LAMP.

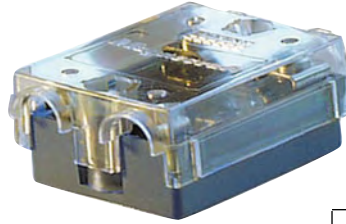

UL **us**
UL Recognized
File No. E52197

CE On selected models

GENERAL SPECIFICATIONS

INPUT CHARACTERISTICS

Control Voltage Range: 3 - 32 VDC
 Typical Input Current: 16 mA
 Must Release Voltage: 1 VDC
 Reverse Polarity Protection: Yes
 Power Indicator: Red L. E. D. Status lamp

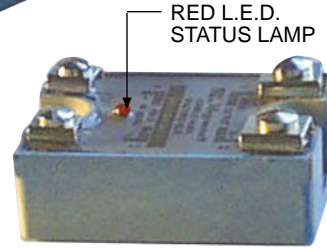

COMPLIES WITH REQUIREMENTS OF

- * IEC STANDARDS 947-4-1 AND 947-5-1 LOW VOLTAGE DIRECTIVE
- * IEC = INTERNATIONAL ELECTROTECHNICAL COMMISSION
- * CE TESTING AND EVALUATION PERFORMED BY THE UNDERWRITERS LABORATORIES AS A THIRD PARTY PARTICIPANT

OUTPUT CHARACTERISTICS

Style:	W62					W64					W66	
Load Voltage Range:	40 - 280 VAC					48 - 560 VAC					48 - 660 VAC	
Rated Load Current:	10 Amp	25 Amp	40 Amp	50 Amp	75 Amp	10 Amp	25 Amp	40 Amp	50 Amp	75 Amp	90 Amp	125 Amp
Maximum Off-State Voltage dv/dt:	200 uS	500 uS	500 uS	500 uS	500 uS	200 uS	300 uS	500 uS	500 uS	500 uS	1000 uS	1000 uS
Minimum Load Current:	50 mA	120 mA	250 mA	250 mA	250 mA	50 mA	250 mA	250 mA	250 mA	250 mA	500 mA	500 mA
Non -Repetitive Surge Current (1 Cycle):	83 A	250 A	625 A	520 A	1150 A	83 A	250 A	625 A	520 A	1150 A	1350 A	1800 A
Maximum off State Leakage Current (Rms):	10 mA	10 mA	10 mA	8 mA	10 mA	10 mA	10 mA	10 mA	10 mA	10 mA	5 mA	5 mA
Typical On-State Voltage Drop (Rms):	1.6 VAC	1.6 VAC	1.6 VAC	1.8 VAC	1.8 VAC	1.6 VAC	1.6 VAC	1.6 VAC	1.8VAC	1.8 VAC	1.8 VAC	1.8 VAC
Maximum I ² T for Fusing (A ² Sec):	83	250	625	1250	5000	72	312	1250	1035	2600	3500	5800
Suggested Heatsink °C/W:	3.2	0.5	0.2	0.014	0.14	3.2	0.5	0.2	0.14	0.14	0.14+fan	0.14+fan

Operating Frequency Range: 25 Hz to 70 Hz
 Maximum Turn - On Time: 40 mS
 Maximum Turn - Off Time: 80 mS

MISCELLANEOUS CHARACTERISTICS

Dielectric Strength (Input-to Output Isolation): 4000 V rms
 Insulation Resistance: 10¹⁰ Ω min.
 Operating Temperature Range: -40°C to +80°C
 Storage Temperature Range: -40°C to +100°C
 Weight: 10 amps to 50 amps: 100 grams approx.
 75 amps to 125 amps: 250 grams approx.

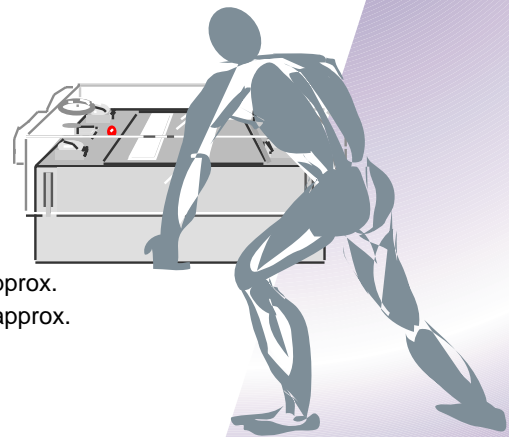

FEATURES

- * RED L. E. D. STATUS LAMP
- * CLEAR SAFETY COVER
- * UP TO 660 VAC OUTPUTS
- * HIGH TRANSIENT CAPABILITY— SINGLE OUTPUT FEATURES BACK TO BACK SCR'S AND INTERNALLY MOUNTED RC (SNUBBER) NETWORK FOR HIGH DV/DT APPLICATIONS.
- * PHOTO-ISOLATED, ZERO VOLTAGE SWITCHING
- * OPTICALLY COUPLED FOR 4000 VAC ISOLATION BETWEEN INPUT AND OUTPUT AND RFI SUPPRESSION.
- * LIFETIME WARRANTY

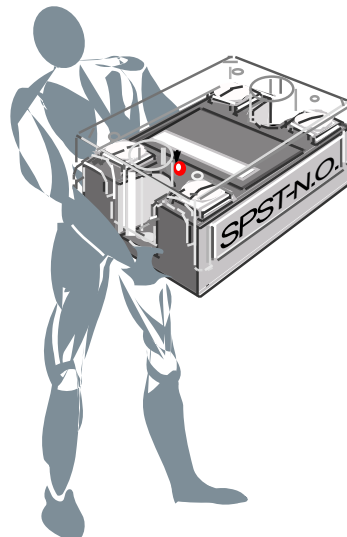

PART NUMBERS	RATED LOAD CURRENT
W6210DSX-1	10 AMPS
*W6225DSX-1	25 AMPS
W6240DSX-1	40 AMPS
W6250DSX-1	50 AMPS
W6275DSX-1	75 AMPS
W6410DSX-1	10 AMPS
W6425DSX-1	25 AMPS
W6440DSX-1	40 AMPS
W6450DSX-1	50 AMPS
W6475DSX-1	75 AMPS
W6690DSX-1	90 AMPS
W66125DSX-1	125 AMPS

* **CE** Approved

SEE END OF SECTION 2 FOR CROSS REFERENCE

DDX SERIES
FOR D.C. SWITCHING 12 TO 40 AMPS

DC CONTROLLED INPUT
DC MOSFET OUTPUT
L. E. D. STATUS LAMP.

UL **us**
 UL Recognized
 File No. E52197

GENERAL SPECIFICATIONS

INPUT CHARACTERISTICS

Control Voltage Range:	3 - 32 VDC
Typical Input Current:	10 mA
Must Release Voltage:	1 VDC
Power Indicator:	Red L. E. D. Status lamp

OUTPUT CHARACTERISTICS

	W62		
	2 - 200 VDC		
Load Voltage Range:	12 Amp	25 Amp	40 Amp
Rated Load Current:	20 mA	20 mA	20 mA
Minimum Load Current:	27 A	50 A	90 A
Non -Repetitive Surge Current (1 Cycle):	8 mA	8 mA	8 mA
Maximum Off State Leakage Current (Rms):	1.6 VAC	1.6 VAC	1.6 VAC
Typical On-State Voltage Drop (Rms):	1.0	0.5	0.14
Suggested Heatsink °C/W:	600 μ S		
Maximum Turn - On Time:	2.6 mS		
Maximum Turn - Off Time:			

MISCELLANEOUS CHARACTERISTICS

Dielectric Strength (Input-to Output Isolation):	2500 V rms
Insulation Resistance:	10 ¹⁰ Ω min.
Operating Temperature Range:	-40°C to +80°C
Storage Temperature Range:	-40°C to +100°C
Weight:	100 grams approx.

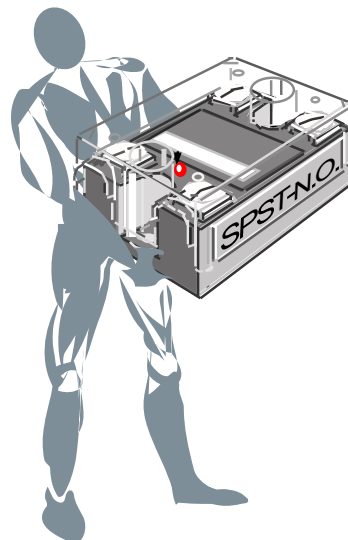
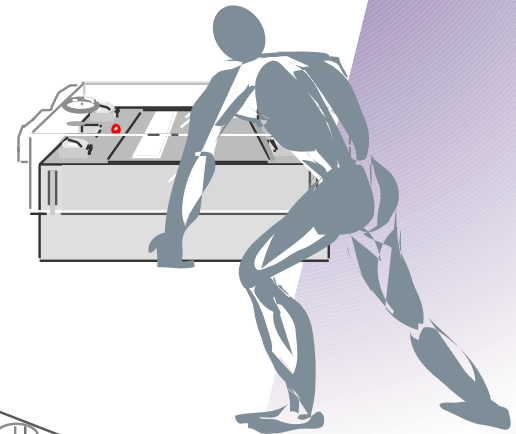
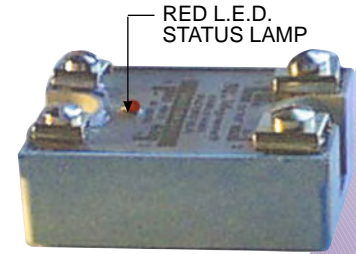

FEATURES

- * RED L. E. D. STATUS LAMP
- * CLEAR SAFETY COVER
- * UP TO 200 VDC OUTPUTS
- * 2500 VAC ISOLATION BETWEEN INPUT AND OUTPUT AND RFI SUPPRESSION.
- * LIFETIME WARRANTY

SEE END OF SECTION 2 FOR CROSS REFERENCE

PART NUMBERS	RATED LOAD CURRENT
W6212DDX-1	12 AMPS
W6225DDX-1	25 AMPS
W6240DDX-1	40 AMPS

**DTX SERIES
10 TO 40 AMPS**

**DC CONTROLLED INPUT
AC TRIAC OUTPUT
L. E. D. STATUS LAMP.
NORMALLY OPEN OR
NORMALLY CLOSED CONTACTS.**

UL us
UL Recognized
File No. E52197

GENERAL SPECIFICATIONS

INPUT CHARACTERISTICS

Control Voltage Range: 3 - 32 VDC
 Typical Input Current: W62: 2 mA; W64: 16 mA
 Must Release Voltage: 1 VDC
 Reverse Polarity Protection: Yes
 Power Indicator: Red L. E. D. Status lamp

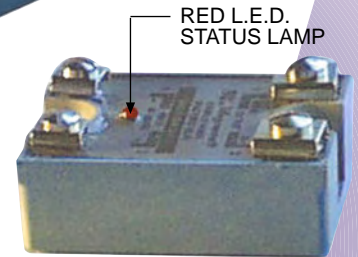

RED L.E.D. STATUS LAMP

OUTPUT CHARACTERISTICS

Style:	W62			W64		
	24 - 280 VAC			48 - 480 VAC		
Load Voltage Range:	10 Amp	25 Amp	40 Amp	10 Amp	25 Amp	40 Amp
Rated Load Current:	250 uS	250 uS	250 uS	200 uS	250 uS	250 uS
Maximum Off-State Voltage dv/dt:	50 mA	120 mA	50 mA	50 mA	20 mA	250 mA
Minimum Load Current:	100 A	250 A	250 A	100 A	250 A	250 A
Non -Repetitive Surge Current (1 Cycle):	10 mA	10 mA	10 mA	10 mA	10 mA	10 mA
Maximum Off State Leakage current (Rms):	1.6 VAC	1.6 VAC	1.6 VAC	1.6 VAC	1.6 VAC	1.6 VAC
Typical On-State Voltage Drop (Rms):	52	300	438	35	200	250
Maximum I ² T for Fusing (A ² Sec):	3.2	0.5	1.4	3.2	0.5	0.2
Suggested Heatsink °C/W:						

Operating Frequency Range: 25 Hz to 70 Hz
 Maximum Turn - On Time: 40 mS
 Maximum Turn - Off Time: 80 mS

MISCELLANEOUS CHARACTERISTICS

Dielectric Strength (Input-to Output Isolation): 4000 V rms
 Insulation Resistance: 10¹⁰ Ω Min.
 Operating Temperature Range: -40°C to +80°C
 Storage Temperature Range: -40°C to +100°C
 Weight: 100 grams approx.

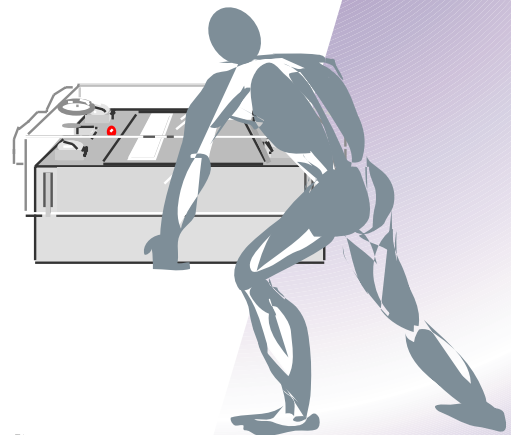

FEATURES

- * RED L. E. D. STATUS LAMP
- * CLEAR SAFETY COVER
- * UP TO 480 VAC OUTPUTS
- * HIGH TRANSIENT CAPABILITY—SINGLE OUTPUT FEATURES TRIAC AND INTERNALLY MOUNTED RC (SNUBBER) NETWORK FOR HIGH DV/DT APPLICATIONS.
- * PHOTO-ISOLATED, ZERO VOLTAGE SWITCHING
- * OPTICALLY COUPLED FOR 4000 VAC ISOLATION BETWEEN INPUT AND OUTPUT AND RFI SUPPRESSION.
- * LIFETIME WARRANTY

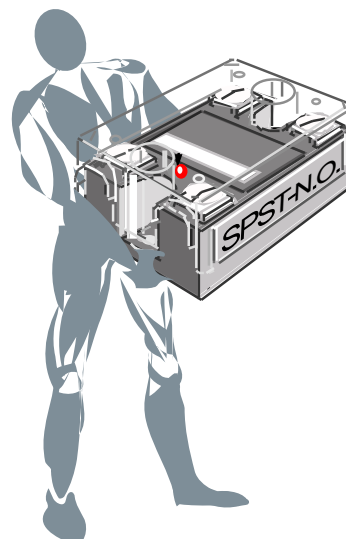

SEE END OF SECTION 2 FOR CROSS REFERENCE

PART NUMBERS	RATED LOAD CURRENT
NORMALLY OPEN CONTACTS	
W6210DTX-1	10 AMPS
W6225DTX-1	25 AMPS
W6240DTX-1	40 AMPS
W6410DTX-1	10 AMPS
W6425DTX-1	25 AMPS
W6440DTX-1	40 AMPS
NORMALLY CLOSED CONTACTS	
W6210DTX-4	10 AMPS
W6225DTX-4	25 AMPS
W6240DTX-4	40 AMPS

DTX SERIES DPST-N.O. 10 AMPS

DC CONTROLLED INPUT
AC DOUBLE-POLE OUTPUT
L. E. D. STATUS LAMP.

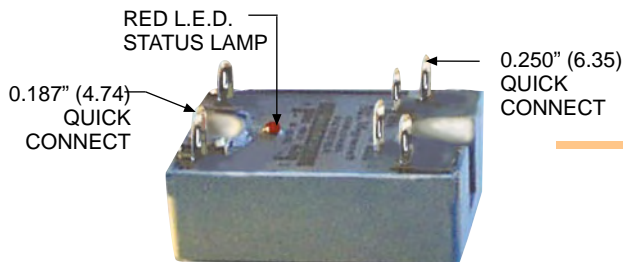

OUTLINE DIMENSIONS
DIMENSIONS SHOWN IN INCHES & (MILLIMETERS).

GENERAL SPECIFICATIONS

INPUT CHARACTERISTICS

Control Voltage Range:	3.5 - 32 VDC
Typical Input current:	2 mA
Must Release Voltage:	1 VDC
Reverse Polarity Protection:	Yes
Power Indicator:	Red L. E. D. Status lamp

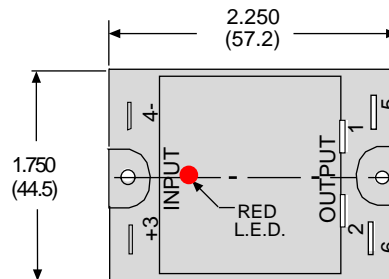

OUTPUT CHARACTERISTICS

Load Voltage Range:	24-280 VAC
Rated Load Current:	10 amp
Maximum off-State Voltage dv/dt:	250 V/uSEC
Minimum Load Current:	50 mA
Non -Repetitive Surge Current (1 Cycle):	100 amp
Maximum Off State Leakage current (Rms):	10 mA
Typical On-State Voltage Drop (Rms):	1.6 VAC
Suggested Heatsink °C/W:	1
Operating Frequency Range:	25 Hz to 70 Hz
Maximum Turn - On Time:	1/2 Hz
Maximum Turn - Off Time:	1/2 Hz

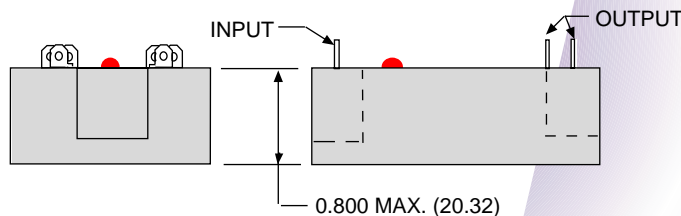

MISCELLANEOUS CHARACTERISTICS

Dielectric Strength (Input-to Output Isolation):	2500 V rms
Insulation Resistance:	10 ¹⁰ Ω
Operating Temperature Range:	-40°C to +80°C
Storage Temperature Range:	-40°C to +100°C
Weight:	100 grams approx.

FEATURES

- * RED L. E. D. STATUS LAMP
- * CLEAR SAFETY COVER
- * UP TO 280 VAC OUTPUTS
- * HIGH TRANSIENT CAPABILITY—
SINGLE OUTPUT FEATURES TRIAC AND INTERNALLY MOUNTED RC (SNUBBER) NETWORK FOR HIGH DV/DT APPLICATIONS.
- * PHOTO-ISOLATED, ZERO VOLTAGE SWITCHING
- * OPTICALLY COUPLED FOR 2500 VAC ISOLATION BETWEEN INPUT AND OUTPUT AND RFI SUPPRESSION.
- * LIFETIME WARRANTY

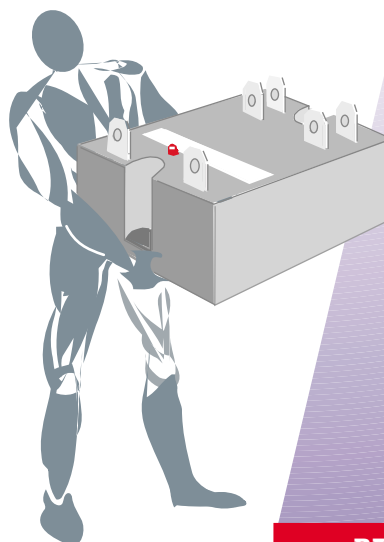

PART NUMBERS	RATED LOAD CURRENT
W6210DTX-3	10 AMPS

SPST-N.O. 2.5 TO 25 AMPS

BENEFITS

- * EXCELLENT TRANSIENT PROTECTION
- * HIGH SURGE CURRENT CAPABILITY
- * OPTICALLY ISOLATED
- * HIGH BLOCKING VOLTAGE
- * EXTREMELY LONG LIFE
- * MINIATURE BUT MIGHTY; UP TO 25 AMP SWITCHING

**FORMERLY
GRAYHILL**



DC INPUT-AC OUTPUT

MAX. LOAD CURRENT	CONTROL VOLTAGE RANGE	NOMINAL LOAD VOLTAGE	DESCRIPTION AND FEATURES	STYLE
2.5 A	3-30 or 6-30 VDC	24, 120 or 240 VAC	MINIATURE PRINTED CIRCUIT MOUNT RELAY, ONLY 0.500" HIGH	H
3 A	3-32 or 6-32 VDC	24, 120 or 240 VAC	SINGLE IN - LINE PACKAGE, USES ONLY 0.680 SQ. INCHES BOARD AREA	V
4 A	3-30 or 6-30 VDC	24, 120 or 240 VAC	COMPACT RELAY, PRINTED CIRCUIT MOUNT	F
6 A	3-30 or 6-30 VDC	120 or 240 VAC	LOW PROFILE RELAY, PANEL OR PRINTED CIRCUIT MOUNT	L
6 A	3-30 or 6-30 VDC	120 or 240 VAC	COMPACT RELAY, PANEL OR PRINTED CIRCUIT MOUNT	M
6 A	3-30 or 6-30 VDC	120 or 240 VAC	COMPACT RELAY, MEETS FIT/FUNCTION REPLACEMENTS FOR LARGER CLASS 6 STYLE RELAYS, QUICK CONNECT TERMINALS	N
6 A	3-30 or 6-30 VDC	120 or 240 VAC	COMPACT RELAY, MEETS FIT/FUNCTION REPLACEMENTS FOR LARGER CLASS 6 STYLE RELAYS, SCREW TERMINALS	S
10 A	3-30 or 6-30 VDC	120 or 240 VAC	COMPACT RELAY, PANEL OR PRINTED CIRCUIT MOUNT 10 AMP	M
12 A	3-30 or 6-30 VDC	120 or 240 VAC	COMPACT RELAY, MEETS FIT/FUNCTION REPLACEMENTS FOR LARGER CLASS 6 STYLE RELAYS, QUICK CONNECT TERMINALS	N
12 A	3-30 or 6-30 VDC	120 or 240 VAC	COMPACT RELAY, MEETS FIT/FUNCTION REPLACEMENTS FOR LARGER CLASS 6 STYLE RELAYS, SCREW TERMINALS	S
25 A	3-30 VDC	120 or 240 VAC	HIGH OUTPUT VERSION OF ABOVE STYLE "S"	S

DC INPUT-DC OUTPUT

MAX. LOAD CURRENT	CONTROL VOLTAGE RANGE	NOMINAL LOAD VOLTAGE	DESCRIPTION AND FEATURES	STYLE
3 A	3-15 or 9-30 VDC	3 to 60 VDC	SINGLE IN - LINE PACKAGE, USES ONLY 0.680 SQ. INCHES BOARD SPACE	V
3 A	3-15 or 9-30 VDC	3 to 60 VDC	COMPACT RELAY, PRINTED CIRCUIT. MOUNT	F
5 A	3-15 VDC	3 to 60 VDC	COMPACT RELAY, MEETS FIT/FUNCTION REPLACEMENTS FOR LARGER CLASS 6 STYLE RELAYS, QUICK CONNECT TERMINALS	N
5 A	3-15 VDC	3 to 60 VDC	COMPACT RELAY, MEETS FIT/FUNCTION REPLACEMENTS FOR LARGER CLASS 6 STYLE RELAYS, SCREW TERMINALS	S

ORDERING CODE FOR RELAYS

70S2- 04- D- 03 - V

CLASS: _____

CONTROLVOLTAGE:

- 01 = 3 - 15 VDC, DC/DC RELAYS
- 02 = 9 - 30 VDC, DC/DC RELAYS
- 03 = 3 - 30 VDC, 25 A COMPACT RELAY
- 04 = 3 - 30 VDC (OR 32 VDC), DC/AC RELAYS
- 05 = 6 - 30 VDC (OR 32 VDC), DC/AC RELAYS

CONTROLVOLTAGE:

- A = 3-60 VDC B = 120 VAC
- C = 240 VAC D = 24 VAC

MAX CURRENT RATING

- 02 = 2.5 A 04 = 4 A 06 = 6 A 12 = 12 A
- 03 = 3 A 05 = 5 A 10 = 10A 25 = 25 A

PACKAGE STYLE

F, H, L, M, N, S OR V.

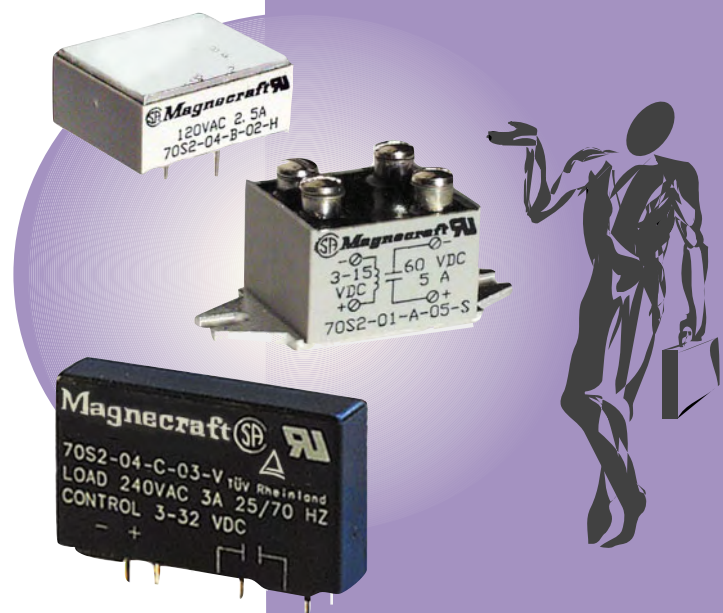

SPST-N.O. 3 AMPS

**DC CONTROLLED INPUT
AC OR DC OUTPUT.**

OUTLINE DIMENSIONS
DIMENSIONS SHOWN IN INCHES & (MILLIMETERS).

UL us
UL Recognized
File No. E52197

SP 168986

TUV on
Selected models

Figure 1: Maximum Continuous Current vs. Ambient Temperature

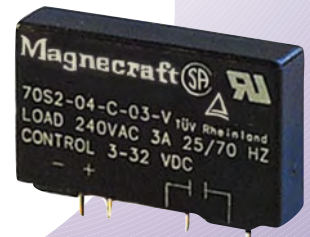
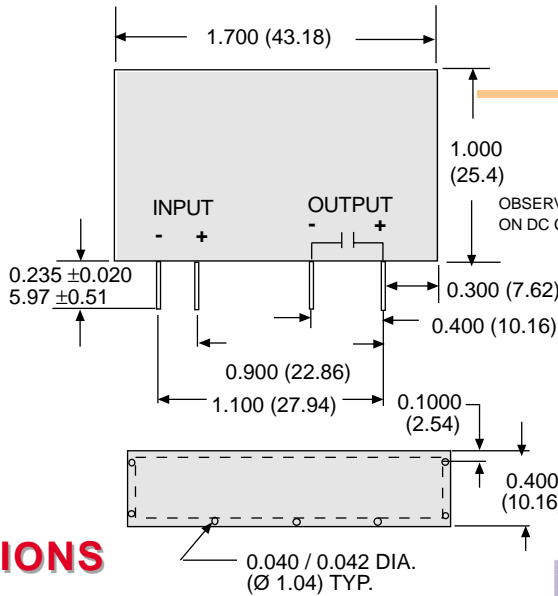
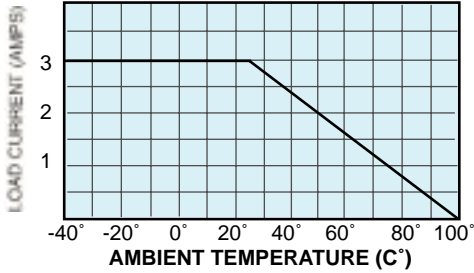

STYLE V

GENERAL SPECIFICATIONS

INPUT CHARACTERISTICS

Style:
Control Voltage Range:
Typical Input Current:
Must Release Voltage:
Max. Reverse Control Voltage:

	70S2-04-D	70S2-05-D	70S2-04-B	70S2-05-B	70S2-04-C	70S2-05-C	70S2-01-A	70S2-02-A
Control Voltage Range:	3 - 32 VDC	6 - 32 VDC	3 - 32 VDC	6 - 32 VDC	3 - 32 VDC	6 - 32 VDC	3 - 15 VDC	9 - 30 VDC
Typical Input Current:	1.0 - 19 mA	1.0 - 6.0 mA	1.0 - 19 mA	1.0 - 6.0 mA	1.0 - 19 mA	1.0 - 6.0 mA	5 - 40 mA	5 - 17 mA
Must Release Voltage:	1.0 VDC	1.0 VDC	1.0 VDC	1.0 VDC	1.0 VDC	1.0 VDC	1.0 VDC	1.0 VDC
Max. Reverse Control Voltage:	3 VDC	3 VDC	3 VDC	3 VDC	3 VDC	3 VDC	3 VDC	3 VDC

OUTPUT CHARACTERISTICS

Load Voltage Range:
Rated Load Current :
Maximum off-State Voltage dv/dt:
Minimum Load Current:
Non-Repetitive Surge Current (1 Cycle):
Maximum Off State Leakage Current (Rms):
Typical On-State Voltage Drop(Rms):
Minimum Peak Blocking Voltage:
Operating Frequency Range:
Maximum Turn - On Time:
Maximum Turn - Off Time:

	70S2-04-D	70S2-05-D	70S2-04-B	70S2-05-B	70S2-04-C	70S2-05-C	70S2-01-A	70S2-02-A
Load Voltage Range:	8 - 50 VAC	8 - 50 VAC	24 - 140 VAC	24 - 140 VAC	24 - 280 VAC	24 - 280 VAC	3 - 60 VDC	3 - 60 VDC
Rated Load Current :	3 Amps	3 Amps	3 Amps	3 Amps	3 Amps	3 Amps	3 Amps	3 Amps
Maximum off-State Voltage dv/dt:	3000 V/u Sec Typ.							
Minimum Load Current:	75 mA	75 mA	75 mA	75 mA	75 mA	75 mA	100 mA	100 mA
Non-Repetitive Surge Current (1 Cycle):	60 Amps Peak @ 25°C						5 Amps/1 Sec.	
Maximum Off State Leakage Current (Rms):	3 mA	3 mA	6 mA	6 mA	6 mA	6 mA	10 uA	10 uA
Typical On-State Voltage Drop(Rms):	1.6	1.6	1.6	1.6	1.6	1.6	1.2 VDC	1.2 VDC
Minimum Peak Blocking Voltage:	200 V	200 V	400 V	400 V	600 V	600 V	105 VDC	105 VDC
Operating Frequency Range:	25 to 70 Hz	25 to 70 Hz	25 to 70 Hz	25 to 70 Hz	25 to 70 Hz	25 to 70 Hz	DC	DC
Maximum Turn - On Time:	8.3 mS	8.3 mS	8.3 mS	8.3 mS	8.3 mS	8.3 mS	75 uS	75 uS
Maximum Turn - Off Time:	8.3 mS	8.3 mS	8.3 mS	8.3 mS	8.3 mS	8.3 mS	500 uS	500 uS

MISCELLANEOUS CHARACTERISTICS

Dielectric Strength (Input- Output Insulation):
Insulation Resistance:
Operating Temperature Range:
Storage Temperature Range:
Weight:

Dielectric Strength (Input- Output Insulation):	3750 V rms.	3750 V rms.	3750 V rms.	3750 V rms.	3750 V rms.	3750 V rms.	2500 V rms.	2500 V rms.
Insulation Resistance:	10 ¹⁰ Ω Min.							
Operating Temperature Range:	-40°C to +100°C							
Storage Temperature Range:	-40°C to +125°C							
Weight:	25 grams approx.							

FEATURES

- * SINGLE IN LINE PACKAGE RELAY.
- * OPTICALLY ISOLATED.
- * PC MOUNT.
- * SWITCHES UP TO 3 AMP LOADS.
- * MINIMAL BOARD SPACE REQUIRED.
- * LIFETIME WARRANTY.

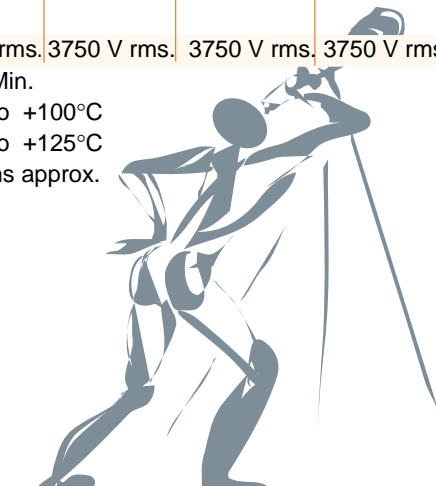

CONSULT FACTORY FOR OTHER CONFIGURATIONS

PART NUMBERS	LOAD VOLTAGE RANGE	RATED LOAD CURRENT
--------------	--------------------	--------------------

*70S2-04-D-03-V	8 - 50 VAC	3 AMPS
*70S2-05-D-03-V	8 - 50 VAC	3 AMPS
*70S2-04-B-03-V	24 - 140 VAC	3 AMPS
*70S2-05-B-03-V	24 - 140 VAC	3 AMPS
*70S2-04-C-03-V	24 - 280 VAC	3 AMPS
*70S2-05-C-03-V	24 - 280 VAC	3 AMPS
70S2-01-A-03-V	3 - 60 VDC	3 AMPS
70S2-02-A-03-V	3 - 60 VDC	3 AMPS

* TUV

Figure 1: Maximum Continuous Current vs. Ambient Temperature

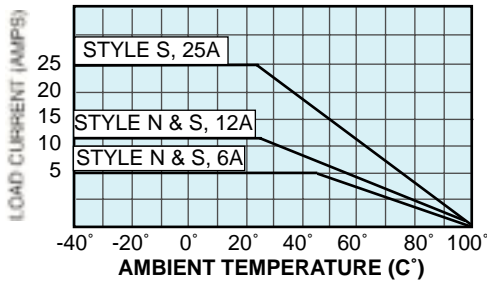

**DC CONTROLLED INPUT
AC OR DC OUTPUT.**

UL **us**
UL Recognized
File No. E52197

SP 168986

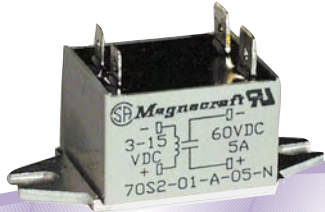

STYLE N



STYLE S



GENERAL SPECIFICATIONS

INPUT CHARACTERISTICS

Style:	70S2-04-B	70S2-05-B	70S2-04-C	70S2-05-C	70S2-03-B	70S2-03-C	70S2-01-A	70S2-02-A
Control Voltage Range:	3 - 30 VDC	6 - 30 VDC	3 - 30 VDC	6 - 30 VDC	3 - 30 VDC	3 - 30 VDC	3 - 15 VDC	9 - 30 VDC
Typical Input Current:	7.0 - 16 mA	6.0 - 10 mA	7.0 - 16 mA	6.0 - 10 mA	7.0 - 16 mA	7.0 - 16 mA	5 - 40 mA	5 - 17 mA
Must Release Voltage:	1.0 VDC	1.0 VDC	1.0 VDC	1.0 VDC	1.0 VDC	1.0 VDC	1.0 VDC	1.0 VDC
Max.Reverse Control Voltage:	3 VDC	3 VDC	3 VDC	3 VDC	3 VDC	3 VDC	3 VDC	3 VDC

OUTPUT CHARACTERISTICS

Load Voltage Range:	24-140 VAC	24-140 VAC	24-280 VAC	24-280 VAC	24-140 VAC	24-280 VAC	3-60 VDC	3-60 VDC
Rated Load Current :	6 Amp 12 Amp	6 Amp 12 Amp	6 Amp 12 Amp	6 Amp 12 Amp	25 Amps	25 Amps	5 Amps	5 Amps
Maximum off-State Voltage dv/dt:	3000 V/u Sec Typ.							
Minimum Load Current:	75 mA 100 mA	75 mA 100 mA	75 mA 100 mA	75 mA 100 mA	100 mA	100 mA	100 mA	100 mA
Non-Repetitive Surge Current (1 Cycle):	60Amp 150Amp	60Amp 150Amp	60Amp 150Amp	60Amp 150Amp	300 Amps	300 Amps	7 Amps/sec	7 Amps/sec
Maximum Off State Leakage Current (Rms):	6 mA	6 mA	6 mA	6 mA	6 mA	6 mA	10 uA	10 uA
Typical On-State Voltage Drop(Rms):	1.6 V	1.6 V	1.6 V	1.6 V	1.7 V	1.7 V	1.85 VDC	1.85 VDC
Minimum Peak Blocking Voltage:	400 V	400 V	600 V	600 V	400 V	600 V	105 VDC	105 VDC
Operating Frequency Range:	25 to 70 Hz	25 to 70 Hz	25 to 70 Hz	25 to 70 Hz	25 to 70 Hz	25 to 70 Hz	-	-
Maximum Turn - On Time:	8.3 mS	8.3 mS	8.3 mS	8.3 mS	8.3 mS	8.3 mS	75 uS	75 uS
Maximum Turn - Off Time:	8.3 mS	8.3 mS	8.3 mS	8.3 mS	8.3 mS	8.3 mS	750 uS	750 uS

MISCELLANEOUS CHARACTERISTICS

Dielectric Strength (Input- Output Insulation):	3000 V rms.	3000 V rms.	3000 V rms.	3000 V rms.	3000 V rms.	3000 V rms.	2500 V rms.	2500 V rms.
Insulation Resistance :	10 ¹⁰ Ω Min.							
Operating Temperature Range:	-40°C to +100°C							
Storage Temperature Range:	-40°C to +125°C							
Weight:	47 grams approx.							

SPST-N.O. 5, 6, 12 & 25 AMPS

OUTLINE DIMENSIONS
DIMENSIONS SHOWN IN INCHES & (MILLIMETERS).

STYLE "S" IS NOT INTENDED FOR PC BOARD MOUNTING CONSULT FACTORY

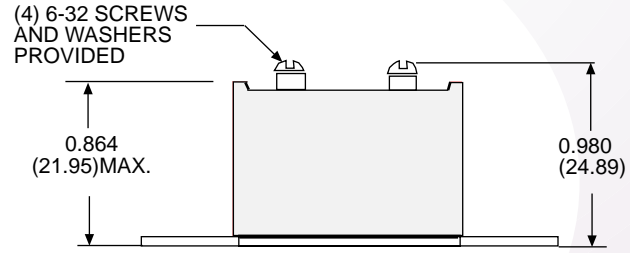
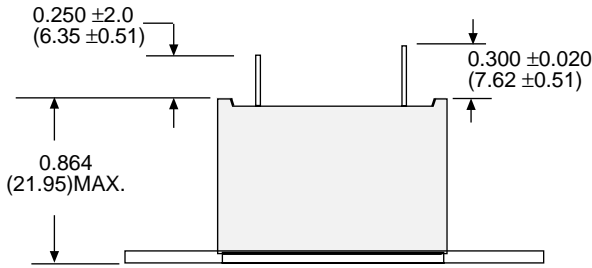

MAXIMUM SCREW TORQUE = 9 IN - LBS

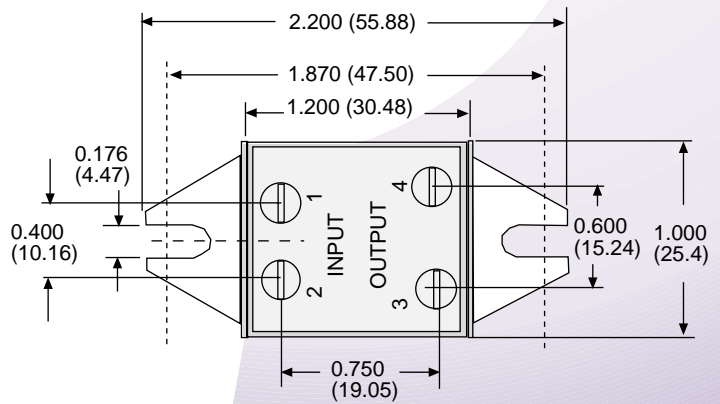
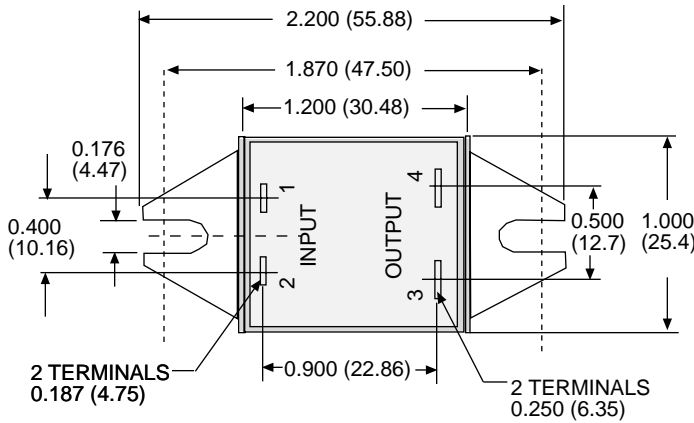

TERMINAL SIDE VIEW

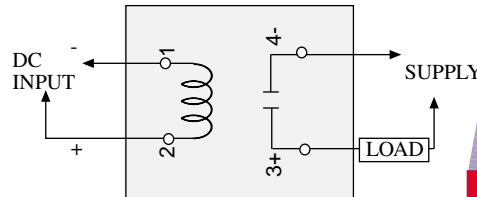

OBSERVE POLARITY ON DC CONNECTIONS



STYLE N



STYLE S

FEATURES

- * OPTICALLY ISOLATED.
- * PANEL MOUNT.
- * SWITCHES UP TO 25 AMP LOADS
- * MOUNTS ON CLASS 6 RELAY CENTERS, YET NEEDS 1/2 THE SPACE
- * SCREW TERMINALS OR PUSH - ON QC TERMINALS
- * LIFETIME WARRANTY



PART NUMBERS	LOAD VOLTAGE RANGE	RATED LOAD CURRENT
70S2-04-B-06-N	24 - 140 VAC	6 AMPS
70S2-05-B-06-N	24 - 140 VAC	6 AMPS
70S2-04-B-12-N	24 - 140 VAC	12 AMPS
70S2-05-B-12-N	24 - 140 VAC	12 AMPS
70S2-04-C-06-N	24 - 280 VAC	6 AMPS
70S2-05-C-06-N	24 - 280 VAC	6 AMPS
70S2-04-C-12-N	24 - 280 VAC	12 AMPS
70S2-05-C-12-N	24 - 280 VAC	12 AMPS
70S2-04-B-06-S	24 - 140 VAC	6 AMPS
70S2-05-B-06-S	24 - 140 VAC	6 AMPS
70S2-04-B-12-S	24 - 140 VAC	12 AMPS
70S2-05-B-12-S	24 - 140 VAC	12 AMPS
70S2-03-B-25-S	24 - 140 VAC	25 AMPS
70S2-04-C-06-S	24 - 280 VAC	6 AMPS
70S2-05-C-06-S	24 - 280 VAC	6 AMPS
70S2-04-C-12-S	24 - 280 VAC	12 AMPS
70S2-05-C-12-S	24 - 280 VAC	12 AMPS
70S2-03-C-25-S	24 - 280 VAC	25 AMPS
70S2-01-A-05-N	3 - 60 VDC	5 AMPS
70S2-01-A-05-S	3 - 60 VDC	5 AMPS
70S2-02-A-05-S	3 - 60 VDC	5 AMPS

SPST-N.O. 3, 4, 6 & 10 AMPS

Figure 1: Maximum Continuous Current vs. Ambient Temperature

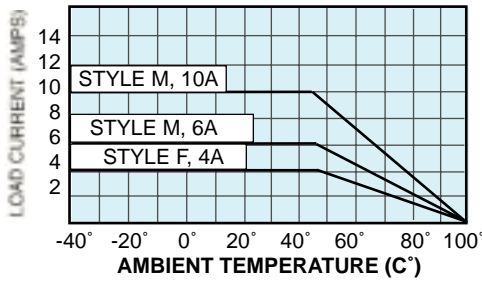

**DC CONTROLLED INPUT
AC OR DC OUTPUT.**

UL
UL Recognized
File No. E52197

CSA 168986

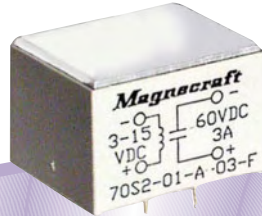

STYLE F

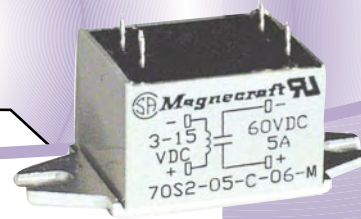

STYLE M



GENERAL SPECIFICATIONS

INPUT CHARACTERISTICS

Style:
Control Voltage Range:
Typical Input Current:
Must Release Voltage:
Max. Reverse Control Voltage:

	70S2-04-B	70S2-05-B	70S2-04-C	70S2-05-C	70S2-01-A	70S2-02-A
Control Voltage Range:	3 - 30 VDC	6 - 30 VDC	3 - 30 VDC	6 - 30 VDC	3 - 15 VDC	9 - 30 VDC
Typical Input Current:	7.0 -16 mA	6.0 -10 mA	7.0 -16 mA	6.0 -10 mA	5 - 40 mA	5 - 17 mA
Must Release Voltage:	1.0 VDC	1.0 VDC	1.0 VDC	1.0 VDC	1.0 VDC	1.0 VDC
Max. Reverse Control Voltage:	3 VDC	3 VDC	3 VDC	3 VDC	3 VDC	3 VDC

OUTPUT CHARACTERISTICS

Load Voltage Range:
Rated Load Current :
Maximum Off-State Voltage dv/dt:
Minimum Load Current:
Non-Repetitive Surge Current (1 Cycle):
Maximum Off State Leakage Current (Rms):
Typical On-State Voltage Drop(Rms):
Minimum Peak Blocking Voltage:
Operating Frequency Range:
Maximum Turn - On Time:
Maximum Turn - Off Time:

	70S2-04-B	70S2-05-B	70S2-04-C	70S2-05-C	70S2-01-A	70S2-02-A
Load Voltage Range:	24-140 VAC	24-140 VAC	24-280 VAC	24-280 VAC	3-60 VDC	3-60 VDC
Rated Load Current :	4 & 6 Amp 10 Amp	4 & 6 Amp 10 Amp	4 & 6 Amp 10 Amp	4 & 6 Amp 10 Amp	3 Amps	3 Amps
Maximum Off-State Voltage dv/dt:	3000 V/u Sec Typ.					
Minimum Load Current:	75 mA 100 mA	75 mA 100 mA	75 mA 100 mA	75 mA 100 mA	100 mA	100 mA
Non-Repetitive Surge Current (1 Cycle):	60 Amp 110 Amp	60 Amp 110 Amp	60 Amp 110 Amp	60 Amp 110 Amp	-	-
Maximum Off State Leakage Current (Rms):	6 mA	6 mA	6 mA	6 mA	10 uA	10 uA
Typical On-State Voltage Drop(Rms):	1.6 V	1.6 V	1.6 V	1.6 V	1.2 VDC	1.2 VDC
Minimum Peak Blocking Voltage:	400 V	400 V	600 V	600 V	105 VDC	105 VDC
Operating Frequency Range:	25 to 70 Hz	25 to 70 Hz	25 to 70 Hz	25 to 70 Hz	-	-
Maximum Turn - On Time:	8.3 mS	8.3 mS	8.3 mS	8.3 mS	75 uS	75 uS
Maximum Turn - Off Time:	8.3 mS	8.3 mS	8.3 mS	8.3 mS	500 uS	500 uS

MISCELLANEOUS CHARACTERISTICS

Dielectric Strength (Input- Output Insulation):
Insulation Resistance:
Operating Temperature Range:
Storage Temperature Range:
Weight:

Dielectric Strength (Input- Output Insulation):	3000 V rms.	3000 V rms	3000 V rms	3000 V rms	2500 V rms.	2500 V rms.
Insulation Resistance:	10 ¹⁰ Ω Min.					
Operating Temperature Range:	-40°C to +100°C					
Storage Temperature Range:	-40°C to +125°C					
Weight:	35 grams approx.					

SPST-N.O. 3, 4, 6 & 10 AMPS

OUTLINE DIMENSIONS
DIMENSIONS SHOWN IN INCHES & (MILLIMETERS).

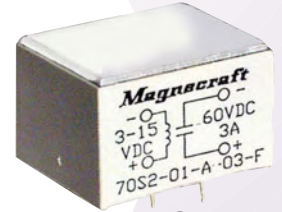
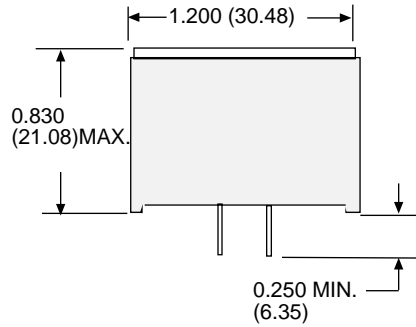
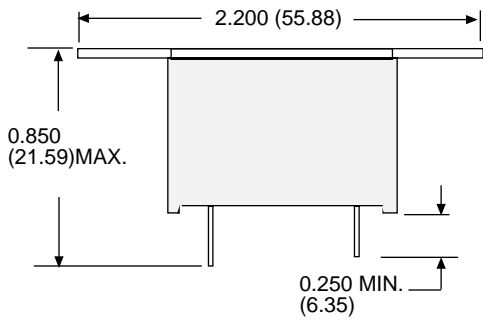

STYLE F

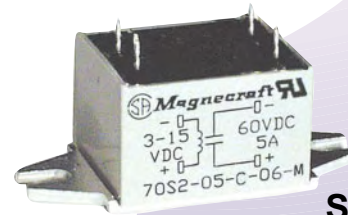
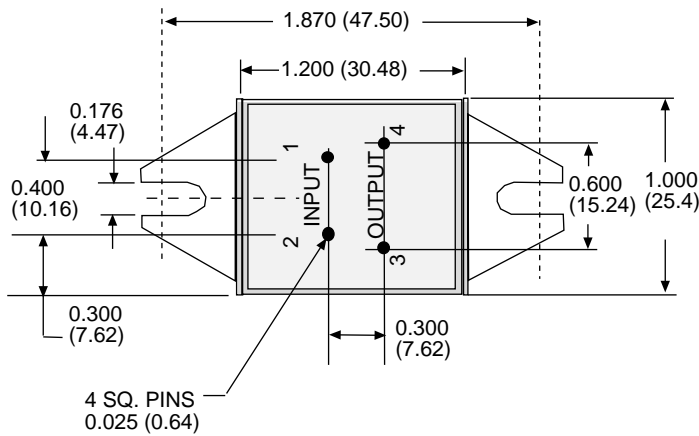

STYLE M

TERMINAL SIDE VIEW

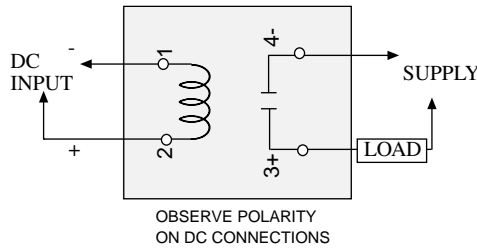

FEATURES

- * OPTICALLY ISOLATED.
- * PANEL OR PRINTED CIRCUIT MOUNT.
- * SWITCHES UP TO 3, 4, 6 OR 10 AMP LOADS.
- * LIFETIME WARRANTY.



PART NUMBERS	LOAD VOLTAGE RANGE	RATED LOAD CURRENT
70S2-04-B-04-F	24 - 140 VAC	4 AMPS
70S2-05-B-04-F	24 - 140 VAC	4 AMPS
70S2-04-C-04-F	24 - 280 VAC	4 AMPS
70S2-05-C-04-F	24 - 280 VAC	4 AMPS
70S2-04-B-06-M	24 - 140 VAC	6 AMPS
70S2-05-B-06-M	24 - 140 VAC	6 AMPS
70S2-04-B-10-M	24 - 140 VAC	10 AMPS
70S2-05-B-10-M	24 - 140 VAC	10 AMPS
70S2-04-C-06-M	24 - 280 VAC	6 AMPS
70S2-05-C-06-M	24 - 280 VAC	6 AMPS
70S2-04-C-10-M	24 - 280 VAC	10 AMPS
70S2-05-C-10-M	24 - 280 VAC	10 AMPS
70S2-01-A-03-F	3 - 60 VDC	3 AMPS
70S2-02-A-03-F	3 - 60 VDC	3 AMPS

SPST-N.O. 2.5 & 6 AMPS

Figure 1: Maximum Continuous Current vs. Ambient Temperature

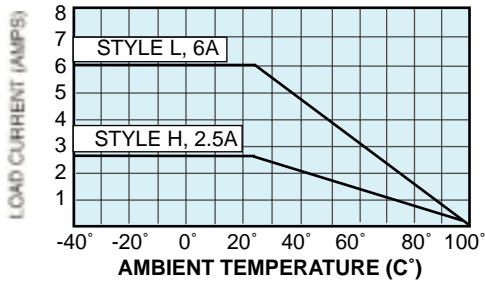

**DC CONTROLLED INPUT
AC OUTPUT.**

UL us
UL Recognized
File No. E52197

SF 168986



STYLE H



STYLE L



GENERAL SPECIFICATIONS

INPUT CHARACTERISTICS

Style:	70S2-04-D	70S2-05-D	70S2-04-B	70S2-05-B	70S2-04-C	70S2-05-C
Control Voltage Range:	3 - 30 VDC	6 - 30 VDC	3 - 30 VDC	6 - 30 VDC	3 - 30 VDC	6 - 30 VDC
Typical Input Current:	1.0 - 17 mA	1.0 - 6.0 mA	1.0 - 17 mA	1.0 - 6.0 mA	1.0 - 17 mA	1.0 - 6.0 mA
Must Release Voltage:	1.0 VDC	1.0 VDC	1.0 VDC	1.0 VDC	1.0 VDC	1.0 VDC
Max. Reverse Control Voltage:	3 VDC	3 VDC	3 VDC	3 VDC	3 VDC	3 VDC

OUTPUT CHARACTERISTICS

Load Voltage Range:	8 - 50 VAC	8 - 50 VAC	24 - 140 VAC	24 - 140 VAC	24 - 280 VAC	24 - 280 VAC
Rated Load Current :	2.5 Amps	2.5 Amps	2.5 & 6 Amps	2.5 & 6 Amps	2.5 & 6 Amps	2.5 & 6 Amps
Maximum Off-State Voltage dv/dt	3000 V/u Sec Typ.					
Minimum Load Current:	75 mA	75 mA	75 mA	75 mA	75 mA	75 mA
Non-Repetitive Surge Current (1 Cycle):	60 Amps Peak Max. @ 25°C					
Maximum Off State Leakage Current (Rms):	3 mA	3 mA	6 mA	6 mA	6 mA	6 mA
Typical On-State Voltage Drop(Rms):	1.6 V	1.6 V	1.6 V	1.6 V	1.6 V	1.6 V
Minimum Peak Blocking Voltage:	200 V	200 V	400 V	400 V	600 V	400 V
Operating Frequency Range:	25 to 70 Hz	25 to 70 Hz	25 to 70 Hz	25 to 70 Hz	25 to 70 Hz	25 to 70 Hz
Maximum Turn - On Time:	8.3 mS	8.3 mS	8.3 mS	8.3 mS	8.3 mS	8.3 mS
Maximum Turn - Off Time:	8.3 mS	8.3 mS	8.3 mS	8.3 mS	8.3 mS	8.3 mS

MISCELLANEOUS CHARACTERISTICS

Dielectric Strength (Input- Output Insulation):	2500 V rms. Min.
Insulation Resistance:	10 ¹⁰ Ω Min.
Operating Temperature Range:	-40°C to +100°C
Storage Temperature Range:	-40°C to +125°C
Weight:	22 g Style H, 25 g Style L approx.

SPST-N.O. 2.5 & 6 AMPS

OUTLINE DIMENSIONS

DIMENSIONS SHOWN IN INCHES & (MILLIMETERS).

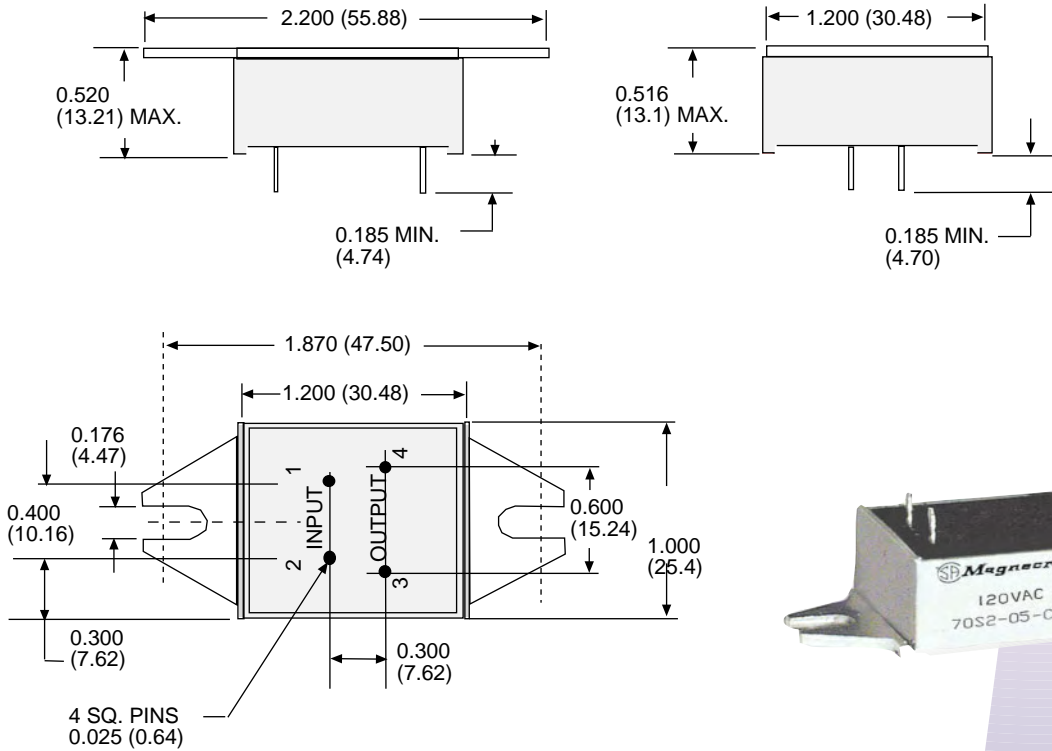

STYLE H



STYLE L

TERMINAL SIDE VIEW

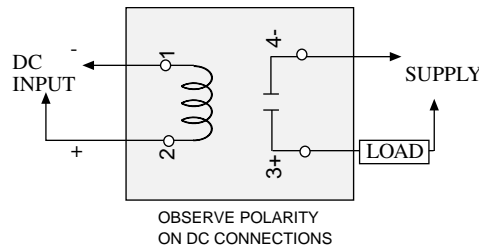

FEATURES

- * OPTICALLY ISOLATED
- * PRINTED CIRCUIT MOUNT
- * SWITCHES UP TO 6 AMP LOADS
- * ONLY 0.5" ABOVE BOARD
- * MINIMAL BOARD SPACE REQUIRED
- * LIFETIME WARRANTY



PART NUMBERS	LOAD VOLTAGE RANGE	RATED LOAD CURRENT
70S2-04-D-02-H	8 - 50 VAC	2.5 AMPS
70S2-05-D-02-H	8 - 50 VAC	2.5 AMPS
70S2-04-B-02-H	24 - 140 VAC	2.5 AMPS
70S2-05-B-02-H	24 - 140 VAC	2.5 AMPS
70S2-04-C-02-H	24 - 280 VAC	2.5 AMPS
70S2-05-C-02-H	24 - 280 VAC	2.5 AMPS
70S2-04-B-06-L	24 - 140 VAC	6 AMPS
70S2-05-B-06-L	24 - 140 VAC	6 AMPS
70S2-04-C-06-L	24 - 280 VAC	6 AMPS
70S2-05-C-06-L	24 - 280 VAC	6 AMPS

SPST-N.O. 4 AMPS

**DC CONTROLLED INPUT
AC OR DC OUTPUT
SOCKET MOUNTABLE**

Figure 1: Maximum Continuous Current vs. Ambient Temperature

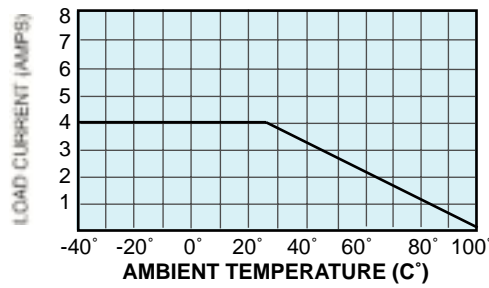

UL **us**
UL Recognized
File No. E52197

SR 168986



Mating Sockets
70-459-1: SCREW/DIN
See Section 8 page 13



GENERAL SPECIFICATIONS

INPUT CHARACTERISTICS

Style:	70S2-04-B	70S2-04-C	70S2-04-D	70S2-04-B	70S2-05-C	70S2-05-D	70S2-01-A	70S2-02-A
Control Voltage Range:	3 - 30 VDC	3 - 30 VDC	3 - 30 VDC	6 - 30 VDC	6 - 30 VDC	6 - 30 VDC	3 - 15 VDC	9 - 30 VDC
Typical Input Current:	1 -17 mA	1 - 17 mA	1 -17 mA	1.0 - 6.0 mA	1.0 -17 mA	1 - 6.0 mA	5 - 40 mA	5 -17 mA
Must Release Voltage:	1.0 VDC	1.0 VDC	1.0 VDC	1.0 VDC	1.0 VDC	1.0 VDC	1.0 VDC	2 VDC
Max. Reverse Control Voltage:	5 VDC	5 VDC	5 VDC	5 VDC	5 VDC	5 VDC	5 VDC	5 VDC

OUTPUT CHARACTERISTICS

Load Voltage Range:	24-140 VAC	24-280 VAC	8 - 50 VAC	24-140 VAC	24-280 VAC	8 - 50 VAC	3 - 60 VDC	3 - 60 VDC
Rated Load Current :	4 Amps	4 Amps	4 Amps	4 Amps	4 Amps	4 Amps	3 Amps	3 Amps
Maximum Off-State Voltage dv/dt	3000 V/u Sec Typ.							
Minimum Load Current:	75 mA	75 mA	75 mA	75 mA	75 mA	75 mA	100 mA	100 mA
Non-Repetitive Surge Current (1 Cycle):	60 Amps Peak Max. @ 25°C						7 Amp-1sec	7 Amp-1sec
Maximum Off State Leakage Current (Rms):	6 mA	6 mA	3 mA	6 mA	6 mA	3 mA	10 uA	10 uA
Typical On-State Voltage Drop(Rms):	1.6 V	1.6 V	1.6 V	1.6 V	1.6 V	1.6 V	1.2 V	1.2 V
Minimum Peak Blocking Voltage:	400 V	600 V	200 V	400 V	600 V	200 V	105 V	105 V
Operating Frequency Range:	25 to 70 Hz	25 to 70 Hz	25 to 70 Hz	25 to 70 Hz	25 to 70 Hz	25 to 70 Hz		
Maximum Turn - On Time:	8.3 mS	8.3 mS	8.3 mS	8.3 mS	8.3 mS	8.3 mS	75 uS	75 uS
Maximum Turn - Off Time:	8.3 mS	8.3 mS	8.3 mS	8.3 mS	8.3 mS	8.3 mS	500 uS	500 uS

MISCELLANEOUS CHARACTERISTICS

Dielectric Strength (Input- Output Insulation):	3000 V rms. Min.
Insulation Resistance:	10 ¹⁰ Ω Min.
Operating Temperature Range:	-40°C to +100°C
Storage Temperature Range:	-40°C to +125°C
Weight:	40 grams approx.

SPST-N.O. 4 AMPS

OUTLINE DIMENSIONS
DIMENSIONS SHOWN IN INCHES & (MILLIMETERS).

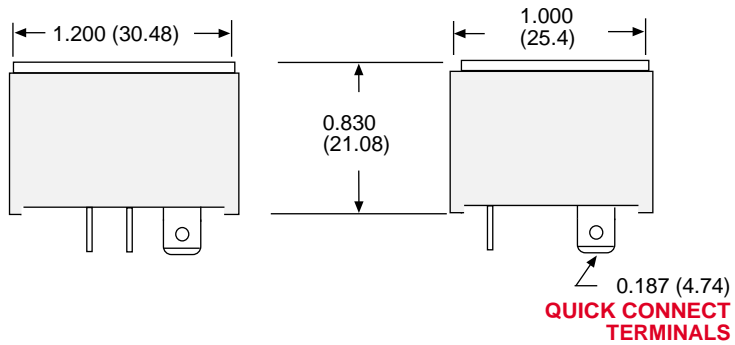

TERMINAL BOTTOM VIEW

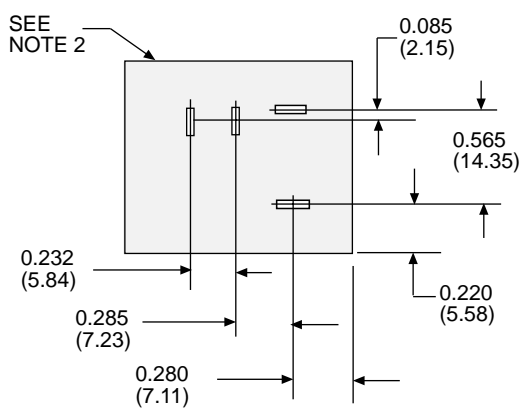

FEATURES

- * OPTICALLY ISOLATED
- * QUICK CONNECT/
SOLDER PLUG-IN MOUNT
- * MATES WITH 70-459-1 SOCKET
- * LIFETIME WARRANTY



PART NUMBERS	LOAD VOLTAGE RANGE	RATED LOAD CURRENT
70S2-04-B-04-K	24 - 140 VAC	4 AMPS
70S2-04-C-04-K	24 - 280 VAC	4 AMPS
70S2-04-D-04-K	8 - 50 VAC	4 AMPS
70S2-05-B-04-K	24 - 140 VAC	4 AMPS
70S2-05-C-04-K	24 - 280 VAC	4 AMPS
70S2-05-D-04-K	8 - 50 VAC	4 AMPS
70S2-01-A-03-K	3 - 60 VDC	3 AMPS
70S2-02-A-03-K	3 - 60 VDC	3 AMPS

SPST-N.O. 7 AMPS

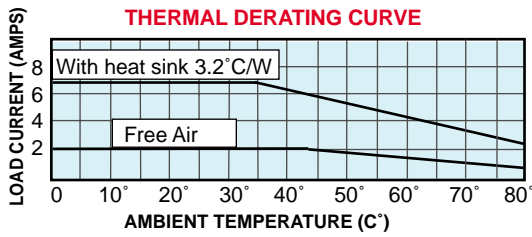

**DC CONTROLLED INPUT
AC OUTPUT.**

UL **SR**
UL Recognized
File No. E52197

OUTLINE DIMENSIONS
DIMENSIONS SHOWN IN INCHES & (MILLIMETERS).

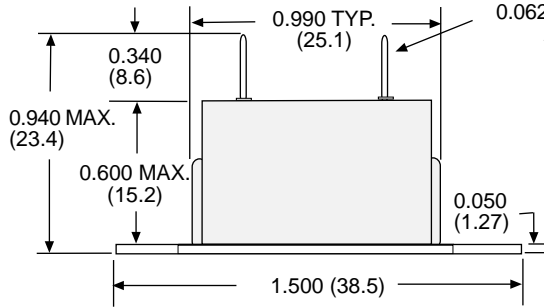

FIG. "A"

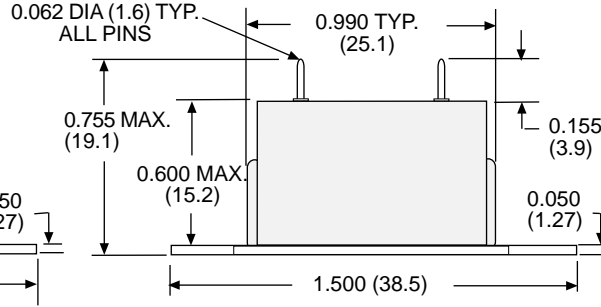
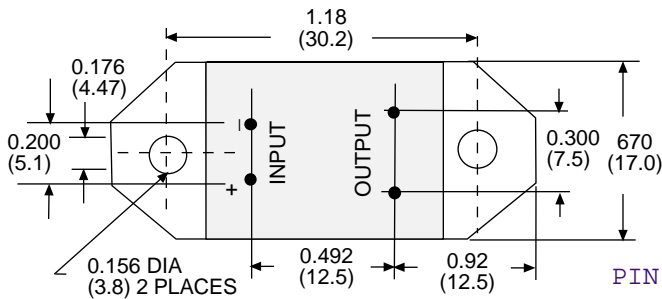
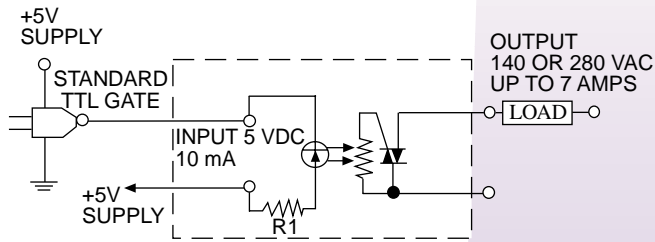

FIG. "B"



PIN SIDE VIEW



GENERAL SPECIFICATIONS

INPUT CHARACTERISTICS

Style:	W226RE-7-	W226RE-8-
Control Voltage Range:	5 VDC	12 VDC
Typical Input Current:	10 mA	10 mA
Must Release Voltage:	1 VDC	1 VDC

OUTPUT CHARACTERISTICS

Load Voltage Range:	140 VAC	280 VAC
Rated Load Current :	7 amps	7 amps
Minimum Load Current:	50 mA	50 mA
Non-Repetitive Surge Current (1 Cycle):	100 Amps	100 Amps
Maximum Off State Leakage Current (Rms):	0.1 mA @ 25°C	10 mA @ 65°C
Typical On-State Voltage Drop(Rms):	1.8 V	3.6 V
Minimum Peak Blocking Voltage:	260 V	380 V
Operating Frequency Range:	25 to 70 Hz	
Maximum Turn - On Time:	10 mS	
Maximum Turn - Off Time:	60 mS	

MISCELLANEOUS CHARACTERISTICS

Dielectric Strength (Input- Output Insulation):	2500 V rms. Min.
Insulation Resistance:	10 ¹⁰ Ω Min.
Operating Temperature Range:	-30°C to +80°C
Storage Temperature Range:	-40°C to +100°C
Weight:	13 grams approx.

PUSH-ON TERMINAL RECEPTACLES

	MOLEX	WINCHESTER
18-22 AWG	02-06-1103	156-10185
24-30 AWG	02-06-1132	156-10245

FEATURES

- * OPTICALLY ISOLATED.
- * PANEL MOUNT.
- * SWITCHES UP TO 7 AMP LOADS.
- * RANDOM VOLTAGE TURN ON.
- * PRINTED CIRCUIT OR PUSH - ON TERMINAL PIN VERSIONS.
- * LIFETIME WARRANTY.

PART NUMBERS	FIGURE	DC CONTROLLED INPUT	MAX. PULL - IN	MIN. DROP-OUT	MAX. OUTPUT CURRENT
PRINTED CIRCUIT TERMINALS					
W226RE-7-5A1	A	5 VDC	4.3 VDC	1.4 VDC	7 AMPS
W226RE-7-12A1	A	12 VDC	10.3 VDC	2.5 VDC	7 AMPS
W226RE-8-5A1	A	5 VDC	4.3 VDC	1.4 VDC	7 AMPS
W226RE-8-12A1	A	12 VDC	10.3 VDC	2.5 VDC	7 AMPS
PUSH ON TERMINALS					
W226R-7-5A1	B	5 VDC	4.3 VDC	1.4 VDC	7 AMPS
W226R-7-12A1	B	12 VDC	10.3 VDC	2.5 VDC	7 AMPS
W226R-8-5A1	B	5 VDC	4.3 VDC	1.4 VDC	7 AMPS
W226R-8-12A1	B	12 VDC	10.3 VDC	2.5 VDC	7 AMPS



SECTION 2 CROSS REFERENCE GUIDE

MAGNECRAFT & STRUTHERS-DUNN	CRYDOM	IDEC	POTTER & BRUMFIELD	GORDOS	OMRON	AROMAT	OPTO 22
W6210ASX-1	A2410		-	84134001	G3NA-210B		240A10
W6225ASX-1	A2425		SSR240A25	84134011	G3NA-225B		240A25
W6240ASX-1	A2440		-	-	G3NA-240B		
W6250ASX-1	A2450		SSR240A50	84134021	-		240A45
W6275ASX-1	A2475		-	84134031	-		
W6410ASX-1	-		-	-	G3NA-410B		
W6425ASX-1	HA4825		SSR480A25	-	G3NA-425B		
W6440ASX-1	-		-	-	G3NA-440B		
W6450ASX-1	HA4850		SSR480A50	-	-		
W6475ASX-1	HA4875		-	-	-		
W6690ASX-1	A2490/HA4890	RSSAN-90A	-	-	-		
W66125ASX-1	A24125/HA48125	-	SSR480A125	84134181	-		
W6210DSX-1	D2410		-	84134000	G3NA-210B	AQP10A2-Z4/30VDC	240D10
W6225DSX-1	D2425		SSR240D25	84134010	G3NA-225B	AQP20A2-Z4/30VDC	240D25
W6240DSX-1	-		-	-	G3NA-240B	AQP40A2-Z4/30VDC	
W6250DSX-1	D2450		SSR240D50	84134020	-		240D45
W6275DSX-1	D2475		-	84134030	-		
W6410DSX-1	-		-	-	G3NA-410B		480D10-12
W6425DSX-1	HD4825		SSR480D25	-	G3NA-425B		380D25/480D25-12
W6440DSX-1	-		-	-	G3NA-440B		
W6450DSX-1	HD4850		SSR480D50	-	-		380D45/480D45-12
W6475DSX-1	HD4875		-	-	-		
W6690DSX-1	D2490/HD4890	RSSDN-90A	-	-	-		
W66125DSX-1	D24125/HD48125	-	SSR480D125	84134080	-		
W6210DTX-1	TD2410		SSRT240D10	84134900			
W6225DTX-1			SSRT240D25	84134910			
W6212DDX-1	D1D12/D2D12				G3NA-D210B		
W6225DDX-1	D1D20				-		
W6240DDX-1	D1D40				-		
MAGNECRAFT & STRUTHERS-DUNN	CONTINENTAL	CRYDOM		GORDOS		CARLO GAVAZZI	
SSR210DIN-AC				84130150 / 84130100		RN1A23A10U	
SSR225DIN-AC				84130152 / 84130102		RN1A23A20U	
SSR610DIN-AC						RN1A60A10U	
SSR625DIN-AC	RSAA-660-25-1D0			84130158 / 84130118		RN1A60A20U	
SSR210DIN-DC		CKRD2410		84130101		RN1A23D10U	
SSR225DIN-DC		HPF2420 / CKRD2430		84130103		RN1A23D20U	
SSR610DIN-DC		CKRD4810				RN1A60D10U	
SSR625DIN-DC	RSDA-660-25-1D0	HPF480D20/CKRD4830/HPF480D30		84130116		RN1A60D20U	
MAGNECRAFT & STRUTHERS-DUNN	CONTINENTAL		CRYDOM	GORDOS		OPTO 22	
70S2-01-A-03-V	ODC-05/ODC-15					DC60MP	
70S2-02-A-03-V	ODC-24						
70S2-04-B-03-V	OAC-05/OAC-15/OAC-24		MP120D3	MOAC5L/MOAC24L/MOACU		MP120D2/MP120D4	
70S2-04-C-03-V	RP03-24/280-04A/OAC-05A/OAC-15A/OAC-24A		MP240D3	GA8-6B02/GA8-6D05		MP240D2/MP120D4	
70S2-04-C-12-N			EZ240D12			Z240D10	
70S2-05-C-12-N			EZE240D12				

THE CROSS REFERENCE IS INTENDED TO MATCH FOOT PRINT, INTERNAL WIRING, AND CONTACT LOAD RATINGS. CONSTRUCTION FEATURES AND GENERAL SPECIFICATIONS SHOULD BE COMPARED IF EXACT REPLACEMENT IS REQUIRED.



SECTION 2 CROSS REFERENCE GUIDE

MAGNECRAFT & STRUTHERS-DUNN	CONTINENTAL	CRYDOM	OPTO 22
70S2-01-A-05-S		DC60S5/DC60S7	DC60S3/DC60S5
70S2-02-A-05-S		DC60S5/DC60S7	
70S2-03-B-25-S		D1225	
70S2-04-B-06-S			120D3
70S2-04-B-12-S		D1210	120D10
70S2-04-C-06-S		NTD2405	240D3
70S2-04-C-12-S	S505-OSJ610-000	D2410/NTD2410	240D10
70S2-03-C-25-S	S505-OSJ625-000	D2425/NTD2425	120D25/240D25

THE CROSS REFERENCE IS INTENDED TO MATCH FOOT PRINT, INTERNAL WIRING, AND CONTACT LOAD RATINGS. CONSTRUCTION FEATURES AND GENERAL SPECIFICATIONS SHOULD BE COMPARED IF EXACT REPLACEMENT IS REQUIRED.

FOR SOLID STATE RELAYS APPLICATION ENGINEERING ASSISTANCE

Scott Heilman, PRODUCT MANAGER
FAX: (843) 395-8530
EMAIL: sheilman@magnecraft.com
FAX ON DEMAND: 1-800-891-2957
DOCUMENT: 500

U. S. A.

TELEPHONE: (843) 393-5778
FAX: (843) 395-4123
WEBSITE: www.magnecraft.com
EMAIL: info@magnecraft.com

EUROPE

TELEPHONE: 4989 / 75080310
FAX: 4989 / 7559344
WEBSITE: www.magnecraft.com
EMAIL: renatesteinback@magnecraft.de



Компания «ЭлектроПласт» предлагает заключение долгосрочных отношений при поставках импортных электронных компонентов на взаимовыгодных условиях!

Наши преимущества:

- Оперативные поставки широкого спектра электронных компонентов отечественного и импортного производства напрямую от производителей и с крупнейших мировых складов;
- Поставка более 17-ти миллионов наименований электронных компонентов;
- Поставка сложных, дефицитных, либо снятых с производства позиций;
- Оперативные сроки поставки под заказ (от 5 рабочих дней);
- Экспресс доставка в любую точку России;
- Техническая поддержка проекта, помощь в подборе аналогов, поставка прототипов;
- Система менеджмента качества сертифицирована по Международному стандарту ISO 9001;
- Лицензия ФСБ на осуществление работ с использованием сведений, составляющих государственную тайну;
- Поставка специализированных компонентов (Xilinx, Altera, Analog Devices, Intersil, Interpoint, Microsemi, Aeroflex, Peregrine, Syfer, Eurofarad, Texas Instrument, Miteq, Cobham, E2V, MA-COM, Hittite, Mini-Circuits, General Dynamics и др.);

Помимо этого, одним из направлений компании «ЭлектроПласт» является направление «Источники питания». Мы предлагаем Вам помощь Конструкторского отдела:

- Подбор оптимального решения, техническое обоснование при выборе компонента;
- Подбор аналогов;
- Консультации по применению компонента;
- Поставка образцов и прототипов;
- Техническая поддержка проекта;
- Защита от снятия компонента с производства.



Как с нами связаться

Телефон: 8 (812) 309 58 32 (многоканальный)

Факс: 8 (812) 320-02-42

Электронная почта: org@eplast1.ru

Адрес: 198099, г. Санкт-Петербург, ул. Калинина, дом 2, корпус 4, литера А.