

# RFID System V680 Series

CSM\_V680 Series\_DS\_E\_1\_1

## RFID Systems with ISO/IEC 18000-3 (ISO/IEC15693) Compliance

- High-speed communications and highly reliable communications provided with an electromagnetic induction system and unique technology.
- Antennas and RF Tags with excellent environmental resistance.
- Wide line-up of ultra-compact, long-life RF Tags, with capacities from 1 to 32 kbytes.
- Visualizes the communications status for simple analysis of the operating environment.
- Complies with FCC Standards and R&TTE Directive.



## System Configuration

Connect V680 Antennas and Amplifier Units to a V680-series Controller, and read or write data from or to RF Tags.



\* For information on the combinations that can be used, refer to *Combinations of Amplifier Units, Antennas, and RF Tags* on pages 2 to 3.

## Handheld Type



**Note:** Certification for radio wave regulations has been acquired for Japan, Europe, the USA, Canada, Mexico, Singapore, Malaysia, the Philippines, China, Taiwan, and Korea, for easy application overseas.  
 Contact your OMRON sales representative for details on whether application is supported in other countries.  
 The latest information on the status of certification for radio wave regulations in various countries can be confirmed on the OMRON website.

\* For information on the combinations that can be used, refer to *Combinations of Amplifier Units, Antennas, and RF Tags* on pages 2 to 3.

## Combinations of Amplifier Units, Antennas, and RF Tags



### 1-kbyte RF Tags

Amplifier Unit	Antenna	EEP-ROM							
		1-kbyte							
		V680-D1KP52MT	V680-D1KP53M	V680-D1KP54T	V680-D1KP66T	V680-D1KP66MT	V680-D1KP66T-SP	V680-D1KP58HT	V680-D1KP52M-BT□1
V680-HA63A V680-HAM42-DRT V680-HAM□1	V680-HS51	Yes	Yes						Yes
	V680-HS52-□	Yes	Yes	Yes	Yes	Yes	Yes		Yes
	V680-HS63-□	Yes*		Yes	Yes	Yes	Yes		
	V680-HS65-□			Yes	Yes	Yes	Yes		
V680-HAM42-PRT	V680-HS63-W	Yes*			Yes	Yes	Yes		
	V680-HS65-W				Yes	Yes	Yes		
V680-H01-V2 (Antenna with Built-in Amplifier)				Yes				Yes	
V680-CH□D (Handheld Reader Writer)		Yes	Yes		Yes	Yes	Yes	Yes	

## 2-kbyte RF Tags

Amplifier Unit	Antenna	FRAM			
		2-kbyte			
		V680-D2KF52M 	V680-D2KF67 	V680-D2KF67M 	V680-D2KF52M-BT□1 
V680-HA63B V680-HAM42-DRT V680-HAM□1	V680-HS51	Yes			Yes
	V680-HS52-□	Yes	Yes	Yes	Yes
	V680-HS63-□	Yes*	Yes	Yes	
	V680-HS65-□		Yes	Yes	
V680-HAM42-PRT	V680-HS63-W		Yes	Yes	
	V680-HS65-W		Yes	Yes	
V680-H01-V2 (Antenna with Built-in Amplifier)			Yes		
V680-CH□D (Handheld Reader Writer)		Yes	Yes	Yes	

## 8-kbyte RF Tags

Amplifier Unit	Antenna	FRAM		
		8-kbyte		
		V680-D8KF67 	V680-D8KF67M 	V680-D8KF68 
V680-HA63B V680-HAM42-DRT V680-HAM□1	V680-HS51			
	V680-HS52-□	Yes	Yes	
	V680-HS63-□	Yes	Yes	Yes
	V680-HS65-□	Yes	Yes	Yes
V680-HAM42-PRT	V680-HS63-W			Yes
	V680-HS65-W			Yes
V680-H01-V2 (Antenna with Built-in Amplifier)		Yes		Yes
V680-CH□D (Handheld Reader Writer)		Yes	Yes	Yes

## 32-kbyte RF Tags

Amplifier Unit	Antenna	FRAM
		32-kbyte
		V680-D32KF68 
V680-HA63B V680-HAM42-DRT V680-HAM□1	V680-HS51	
	V680-HS52	
	V680-HS63	Yes
	V680-HS65	Yes
V680-HAM42-PRT	V680-HS63-W	Yes
	V680-HS65-W	Yes
V680-H01-V2 (Antenna with Built-in Amplifier)		Yes
V680-CH□D (Handheld Reader Writer)		Yes

**Note:** For details, refer to the relevant user's manual (Z248, Z249, Z262, Z271, Z272, Z278, and Z279).

\* When using the V680-D1KP52MT or V680-D2KF52M embedded in metal, use the V680-HS51/-HS52 Antenna.

Communications will not be possible if the V680-HS63 Antenna is used.

Communications will not be possible if the V680-HS65 Antenna is used with the V680-D1KP52MT, V680-D1KP53M, or V680-D2KF52M.

Transmission is also possible with RF Tags other than those of the V680 Series as long as they comply with ISO/IEC 18000-3 (ISO/IEC 15693). However, transmission with RF Tags other than those of the V680 Series cannot be assured. The user must confirm transmission capabilities carefully prior to use.

## Ordering Information





## RF Tag

Type	Memory capacity	Appearance	Size	Metallic compatibility	Model
Battery-less	1 kbyte		8 dia. × 5 mm	For embedding in metallic or non-metallic surface	V680-D1KP52MT
			10 dia. × 4.5 mm	For embedding in metallic or non-metallic surface	V680-D1KP53M
			20 dia. × 2.7 mm	For flush mounting on non-metallic surface	V680-D1KP54T
			34 × 34 × 3.5 mm	For flush mounting on metallic surface	V680-D1KP66MT
				For flush mounting on non-metallic surface	V680-D1KP66T
			95 × 36.5 × 6.5 mm	For flush mounting on non-metallic surface	V680-D1KP66T-SP
			80 dia. × t10 mm	For flush mounting on non-metallic surface	V680-D1KP58HT
		M10 × 12 mm	For mounting as bolts	V680-D1KP52M-BT01 *	
		M8 × 12 mm		V680-D1KP52M-BT11 *	
	2 kbytes		8 dia. × 5 mm	For embedding in metallic or non-metallic surface	V680-D2KF52M
			40 × 40 × 4.5 mm	For flush mounting on metallic surface	V680-D2KF67M
				For flush mounting on non-metallic surface	V680-D2KF67
			M10 × 12 mm	For mounting as bolts	V680-D2KF52M-BT01 *
	M8 × 12 mm		V680-D2KF52M-BT11 *		
	8 kbytes		40 × 40 × 4.5 mm	For flush mounting on metallic surface	V680-D8KF67M
				For flush mounting on non-metallic surface	V680-D8KF67
	32 kbytes		86 × 54 × 10 mm	For flush mounting on non-metallic surface	V680-D8KF68
					V680-D32KF68

\* Place orders in units of boxes (containing 20 units).



## Antenna (Detachable Amplifier Unit Type)



Type	Appearance	Size	Cable length	Model	
Cylindrical	Standard cable, waterproof connector		M22 × 65 mm	2 m	V680-HS52-W 2M
				12.5 m	V680-HS52-W 12.5M
	Flexible cable, nonwaterproof connector		2 m	V680-HS52-R 2M	
			12.5 m	V680-HS52-R 12.5M	
	Standard cable, nonwaterproof connector		M12 × 35 mm	2 m	V680-HS51 2M
Square	Standard cable, waterproof connector		40 × 53 × 23 mm	2 m	V680-HS63-W 2M
				12.5 m	V680-HS63-W 12.5M
	Flexible cable, nonwaterproof connector			2 m	V680-HS63-R 2M
				12.5 m	V680-HS63-R 12.5M
	Standard cable, waterproof connector		100 × 100 × 30 mm	2 m	V680-HS65-W 2M
				12.5 m	V680-HS65-W 12.5M
2 m				V680-HS65-R 2M	
	Flexible cable, nonwaterproof connector			12.5 m	V680-HS65-R 12.5M

## Antenna with Built-in Amplifier



Type	Appearance	Size	Cable length	Model
Square		250 × 200 × 35 mm	0.5 m *	V680-H01-V2

\* Use an Antenna Cable to connect the Antenna to the Controller.  
The maximum cable length is 30.5 m.



## Amplifier Unit

Type	Appearance	Size	Cable length	Model
For 1-kbyte memory		25 × 40 × 65 mm	0.5 m	V680-HA63A 0.5M
			5 m	V680-HA63A 5M
			10 m	V680-HA63A 10M
For 2-/8-/32-kbyte memory			0.5 m	V680-HA63B 0.5M
			5 m	V680-HA63B 5M
			10 m	V680-HA63B 10M

## ID Controller

Type	No. of connectable Amplifiers	Appearance	Size	Transmission interface	Model
DC power supply	Single		105 × 90 × 65 mm	RS232C, RS422/RS485	V680-CA5D01-V2
	Dual				V680-CA5D02-V2

## ID Sensor Units



Type	Appearance	Connected ID System		External power supply	No. of unit numbers used	Current consumption (A)			Model
						5 V	24 V	External	
CJ Special I/O Unit		V680 Series	1 Head	-	1 unit number	0.26	0.13 *	-	CJ1W-V680C11
			2 Heads		2 unit number	0.32	0.26	-	CJ1W-V680C12
Type	Appearance	Connected ID System		External power supply	No. of unit numbers used	Current consumption (A)			Model
						5 V	26 V	External	
CS Special I/O Unit		V680 Series	1 Head	-	1 unit number	0.26	0.13 *	-	CS1W-V680C11
			2 Heads		24 VDC	2 unit number	0.32	-	0.36

\* When connected to the V680-H01: 0.28 A

## Amplifier-integrated Controller (DeviceNet ID Slave/PROFIBUS ID Slave)

Appearance	Size	Network Compatibility	Model
	65 × 65 × 65 mm	DeviceNet	V680-HAM42-DRT
		PROFIBUS	V680-HAM42-PRT

## Amplifier-integrated Controllers (ID Flag Sensors)

Type	Appearance	Size	Model
NPN output		90 × 30 × 65 mm	V680-HAM91
PNP output			V680-HAM81

## Special Interface Cables (for V680-HAM91 and V680-HAM81)

Cable length	Model	Appearance
2 m	V680-A60 2M	
5 m	V680-A60 5M	
10 m	V680-A60 10M	

**Note:** 1. The connectors are not waterproof.

2. The cable length can be extended to a maximum of 10 m.





3. Normally two Interface Cables are required for 1 Unit. If you do not need to write to ID Tags, or use the address shift or noise check functions, then one Interface Cable is sufficient.

## Handheld Reader Writers

Name	Appearance	Model
Model with standard serial connector		V680-CH1D
Model with USB connector and 0.8-m cable		V680-CHUD 0.8M
Model with USB connector and 1.9-m cable		V680-CHUD 1.9M
Models for Psion Teklogix Handheld Terminal		V680-CH1D-PSI
AC Adapter (for V680-CH1D)		V600-A22

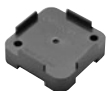
## Accessories (Order Separately)

### RF Tag Attachment

Type	Appearance	Model
For the V680-D1KP66T		V600-A86
For the V680-D□KF68		V680-A81
To mount the V680-D1KP58HT		V680-A80
For the V680-D1KP54T		V700-A80

### Amplifier Unit Special Extension Cable (Amplifier Unit to Controller)

Cable length	Appearance	Model
2 m		V700-A40 2M
3 m		V700-A41 3M
5 m		V700-A42 5M
10 m		V700-A43 10M
20 m		V700-A44 20M
30 m		V700-A45 30M

**Note:** The cable can be extended up to 40 m. Up to two extension cables can be used.

### V680-H01 Antenna Special Cable (Antenna to Controller)

Cable length	Appearance	Model
2 m		V700-A40-W 2M
5 m		V700-A40-W 5M
10 m		V700-A40-W 10M
20 m		V700-A40-W 20M
30 m		V700-A40-W 30M

**Note:** The cable can be extended up to 30 m. Only one extension cable can be used.

### RS-232C Communications Connector

Name	Model
Connector Plug	XM3B-0922-111
Connector Hood	XM2S-0911

\* An RS422/RS485 Communications Connector is attached to the Controller.

### ID Map Manager (for Windows XP)

Type	Model
English version	V680-A-IMMEG-P01

## Psion Teklogix Handheld Terminals

We recommend connecting the V680/V680-CH-PSI Handheld Reader Writer to a Psion Teklogix WORKABOUT PRO-series Handheld Terminal. Psion Teklogix products can be purchased directly from OMRON.

### Handheld Terminal Set

Name	Configuration	OMRON model number
Handheld Terminal Set (English OS)	Handheld Terminal, Serial End Cap, hand strap, charger (standard model), and High-capacity Battery	<b>V680-A-7527S-G3-EG-S</b>



\* The Handheld Terminal Set includes the V600/V680 EasyAccess/CBAAccess Demo Software preinstalled in a 7527S-G3 Psion Teklogix Handheld Terminal and the configuration parts listed above.

### Handheld Terminal Only

Name	Configuration	Appearance	OMRON model number
Handheld Terminal (English OS)	Handheld Terminal, Serial End Cap, and hand strap (Battery sold separately.)		<b>V680-A-7527S-G3-EG</b>

\* The Handheld Terminal includes the V600/V680 EasyAccess/CBAAccess Demo Software preinstalled in a 7527S-G3 Psion Teklogix Handheld Terminal and the configuration parts listed above. The High-capacity Battery is not included.

### Handheld Terminal Accessories

Name	Appearance	Psion Teklogix model number	OMRON model number
High-capacity Battery		<b>WA3006</b>	<b>V680-A-WA3006</b>
Charger (standard model)		<b>PS1050-G1</b>	<b>V680-A-CA1053</b>
Charger (advanced model)		<b>WA4003-G2</b>	<b>V680-A-WA4003</b>
Carrying Case		<b>WA6197-G2</b>	<b>V680-A-WA6197</b>

Refer to the following website for detailed information on Psion Teklogix Handheld Terminals.

<http://www.pSIONteklogix.com/products/handheld/workaboutpro.htm>

## Ratings and Performance

### RF Tag (1-kbyte Memory)

Item	Model	V680-D1KP52MT	V680-D1KP54T	V680-D1KP66T	V680-D1KP66MT	V680-D1KP53M	V680-D1KP66T-SP
Memory capacity		1,000 byte (user area)					
Memory type		EEPROM					
Data retention time *1		10 years after writing (85°C max.)					
Write endurance		100,000 times per block (at 25°C)					
Ambient operating temperature (during transmission)		-25 to 85°C (with no icing)					-25 to 70°C (with no icing)
Ambient storage temperature (during data backup)		-40 to 125°C (with no icing) Heat resistance: 1,000 thermal cycles each of 30 minutes at -10°C/150°C, High-temperature storage: 1,000 hours at 150°C *2 200 thermal cycles each of 30 minutes at -10°C/180°C, High-temperature storage: 200 hours at 180°C *3				-40 to 125°C (with no icing)	-40 to 110°C (with no icing)
Ambient operating humidity		35 to 95%					
Degree of protection		IEC 60529, IP68 In-house standard for antenna oil resistance (former JEM1030 standard equivalent to IP67g) *4					IP67
Vibration resistance		10 to 2,000 Hz, 1.5-mm double amplitude at 150 m/s <sup>2</sup> acceleration with 10 sweeps in X, Y, and Z directions for 15 minutes each					
Shock resistance		500 m/s <sup>2</sup> in X, Y, and Z directions 3 times each (18 times in total)					
Appearance		8 dia. × 5 mm	20 dia. × 2.7 mm	34 × 34 × 3.5 mm		10 dia. × 4.5 mm (DIN698373)	95 × 36.5 × 6.5 mm (excluding protrusions)
Materials		Case: PPS resin Filling: Epoxy resin	Molding: PPS resin			Case: PPS resin Filling: Epoxy resin	External resin: PFA Tag body: PPS resin
Weight		Approx. 0.5 g	Approx. 2 g	Approx. 6 g	Approx. 7.5 g	Approx. 1 g	Approx. 20 g
Metallic compatibility		Yes	No	No	Yes	Yes	No

**Note:** For details, refer to the User's Manual (Cat. No. Z262).

\*1. Refer to the User's Manual (Cat. No. Z262) for data retention time for temperatures of 85°C or higher. If the V680 has been stored at 125°C or higher, write the data again even if the data does not need to be changed.

\*2. 150°C heat resistance: The heat resistance has been checked at 150°C for up to 1,000 hours, and thermal shock has been checked through testing 1,000 thermal cycles each of 30 minutes at -10/150°C. (Test samples: 22, defects: 0)

\*3. 180°C heat resistance: The heat resistance has been checked at 180°C for up to 200 hours, and thermal shock has been checked through testing 200 thermal cycles each of 30 minutes at -10°C/180°C. (Test samples: 22, defects: 0)

\*4. This OMRON in-house standard confirms resistance to cutting and other oils. It is equivalent to the former JEM1030 standard.

### RF Tag with 1-kbyte Memory with High-temperature Capability

Item	Model	V680-D1KP58HT
Memory capacity		1,000 bytes (user area)
Memory type		EEPROM
Data retention time		10 years after writing *
Write endurance		100,000 times per block (at 25°C)
Ambient operating temperature (during transmission)		-10 to 85°C (with no icing)
Ambient storage temperature (during data backup)		-40 to 110°C (with no icing) Heat resistance: 2,000 thermal cycles each of 30 minutes at room temperature/200°C (Refer to Heat Resistance, below, for details.)
Ambient operating humidity		No limits.
Degree of protection		IEC 60529, IP67
Vibration resistance		10 to 2,000 Hz, 1.5-mm double amplitude at 150 m/s <sup>2</sup> acceleration with 10 sweeps in X, Y, and Z directions for 15 minutes each
Shock resistance		500 m/s <sup>2</sup> in X, Y, and Z directions 3 times each (18 times in total)
Materials		PPS resin
Weight		Approx. 90 g

\* The data retention time at high temperatures (110 to 200°C) is 10 hours. Rewrite the data before 10 hours has lapsed.

### Heat Resistance

Sufficient heat resistance has been confirmed by evaluation testing comprising 2,000 thermal cycles each of 30 minutes at room temperature/200°C. The lifetime of the V680-D1KP58HT is affected by high-temperature storage, due to the effects of high temperatures on internal components. For details on the relationship between heat resistance and lifetime, refer to the User's Manual (Cat. No. Z262).

## RF Tag (2-kbyte Memory)

Item	Model	V680-D2KF52M	V680-D2KF67	V680-D2KF67M
Memory capacity		2,000 bytes (user area)		
Memory type		FRAM		
Data retention time *1		10 years after writing (55°C max.)		
Write endurance		Access frequency per block *2: 10 billion times		
Ambient operating temperature		-25 to 85°C (with no icing)		
Ambient storage temperature		-40 to 85°C (with no icing)		
Ambient operating humidity		35 to 95%	35 to 85%	
Degree of protection		IEC 60529, IP67 In-house standard for antenna oil resistance (former JEM1030 standard equivalent to IP67g) *3		
Vibration resistance		10 to 2,000 Hz, 1.5-mm double amplitude at 150 m/s <sup>2</sup> acceleration with 10 sweeps in X, Y, and Z directions for 15 minutes each		
Shock resistance		500 m/s <sup>2</sup> in X, Y, and Z directions 3 times each (18 times in total)		
Appearance		8 dia. × 5 mm	40 × 40 × 4.5 mm	
Materials		Case: PPS resin Filling: Epoxy resin	Molding: PBT resin Filling: Epoxy resin	
Weight		Approx. 0.5 g	Approx. 6.5 g	Approx. 7 g
Metallic compatibility		Yes	No	Yes

**Note:** For details, refer to the User's Manual (Cat. No. Z248).

\*1. Refer to the User's Manual (Cat. No. Z248) for data retention time for temperatures of 55°C or higher.

\*2. The total Read or Write communication frequency is called the access frequency.

\*3. This OMRON in-house standard confirms resistance to cutting and other oils. It is equivalent to the former JEM1030 standard.

## RF Tag with 8-/32-kbyte Memory

Item	Model	V680-D8KF67	V680-D8KF67M	V680-D8KF68	V680-D32KF68
Memory capacity		8,192 bytes (user area)			32,744 bytes (user area)
Memory type		FRAM			
Data retention time *1		10 years after writing (at 70°C max.)			
Write endurance		Access frequency per block *2: 10 billion times			
Ambient operating temperature		-20 to 85°C (with no icing)			
Ambient storage temperature		-40 to 85°C (with no icing)			
Ambient operating humidity		35 to 85%			
Degree of protection		IEC 60529, IP67 In-house standard for antenna oil resistance (former JEM1030 standard equivalent to IP67g) *3			
Vibration resistance		10 to 2,000 Hz, 1.5-mm double amplitude at 150 m/s <sup>2</sup> acceleration with 10 sweeps in X, Y, and Z directions for 15 minutes each		10 to 500 Hz, 1.5-mm double amplitude at 100 m/s <sup>2</sup> acceleration with 10 sweeps in X, Y, and Z directions for 11 minutes each	
Shock resistance		500 m/s <sup>2</sup> in X, Y, and Z directions 3 times each (18 times in total)			
Dimensions		40 × 40 × 4.5 mm		86 × 54 × 10 mm	
Materials		Case: PBT resin Filling: Epoxy resin			
Weight		Approx. 8 g	Approx. 8.5 g	Approx. 50 g	
Metallic compatibility		No	Yes	No *4	

**Note:** For details, refer to the User's Manual (Cat. No. Z248).

\*1. Refer to the User's Manual (Cat. No. Z248) for data retention time for temperatures of 70°C or higher.

\*2. The total Read or Write communication frequency is called the access frequency.

\*3. This OMRON in-house standard confirms resistance to cutting and other oils. It is equivalent to the former JEM1030 standard.

\*4. Using the V680-A81 special attachment improves the influence of flush mounted on metallic surface.

**Bolt RF Tags (1-kbyte Memory)**

Item	Model	V680-D1KP52M-BT01	V680-D1KP52M-BT11
Memory capacity		1,000 bytes (user area)	
Memory type		EEPROM	
Data retention time		10 years after writing (85°C max.)	
Write endurance		100,000 times per block (at 25°C)	
Ambient operating temperature (during transmission)		-25 to 85°C (with no icing)	
Ambient storage temperature (during data backup)		-40 to 125°C (with no icing)	
Ambient operating humidity		35 to 95%	
Degree of protection		IP67 (IEC 60529 standard), In-house standard for oil resistance (Equivalent to former JEM standard IP67g.)	
Vibration resistance		10 to 2,000 Hz, 1.5-mm double amplitude at 150 m/s <sup>2</sup> acceleration with 10 sweeps in X, Y, and Z directions for 15 minutes each	
Shock resistance		500 m/s <sup>2</sup> in X, Y, and Z directions 3 times each (18 times in total)	
Materials		Bolt: SUS303, Case (RF Tag): PPS resin, Filling (RF Tag): Epoxy resin	
Weight		Approx. 25 g	Approx. 10 g

**Bolt RF Tags (2-kbyte Memory)**

Item	Model	V680-D2KF52M-BT01	V680-D2KF52M-BT11
Memory capacity		2,000 bytes (user area)	
Memory type		FRAM	
Data retention time		10 years after writing (at 55°C max.)	
Write endurance		10 billion reads/writes per block, Number of accesses*: 10 billion times	
Ambient operating temperature (during transmission)		-25°C to 85°C (with no icing)	
Ambient storage temperature (during data backup)		-40°C to 85°C (with no icing)	
Ambient operating humidity		35 to 95%	
Degree of protection		IEC 60529, IP67 In-house standard for antenna oil resistance (former JEM1030 standard equivalent to IP67g)	
Vibration resistance		10 to 2,000 Hz, 1.5-mm double amplitude at 150 m/s <sup>2</sup> acceleration with 10 sweeps in X, Y, and Z directions for 15 minutes each	
Shock resistance		500 m/s <sup>2</sup> in X, Y, and Z directions 3 times each (18 times in total)	
Materials		Bolt: SUS303, Case (RF Tag): PPS resin, Filling (RF Tag): Epoxy resin	
Weight		Approx. 25 g	Approx. 10 g

\* The number of accesses is the total number of communications for reading or writing.

**Cylindrical Antenna (Detachable Amplifier Unit Type)**

Item	Model	V680-HS51 (Standard Cable, Non-waterproof Connector)	V680-HS52-W (Standard Cable, Waterproof Connector)	V680-HS52-R (Standard Cable, Non-waterproof Connector)
Ambient operating temperature		-10°C to 60°C (with no icing)		
Ambient storage temperature		-25°C to 75°C (with no icing)		
Ambient operating humidity		35% to 95% (with no condensation)		
Insulation resistance		20 MΩ min. (at 500 VDC) between the cable terminals and the case		
Dielectric strength		1,000 VAC (50/60 Hz) for 1 minute between the cable terminals and the case with a current leakage of 5 mA max.		
Degree of protection		IP67 (IEC60529) In-house standard for antenna oil resistance (former JEM1030 standard equivalent to IP67g) (Antenna portion) *2	IP67 (IEC60529) In-house standard for antenna oil resistance (former JEM1030 standard equivalent to IP67g) (Antenna portion) *1	IP67 (IEC60529) In-house standard for antenna oil resistance (former JEM1030 standard equivalent to IP67g) (Antenna portion) *2
Vibration resistance		10 to 2,000 Hz variable vibration, 1.5-mm double amplitude at 150 m/s <sup>2</sup> acceleration, with 10 sweeps in X, Y, and Z directions for 15 minutes each	10 to 500 Hz variable vibration, 1.5-mm double amplitude at 100 m/s <sup>2</sup> acceleration, with 10 sweeps in X, Y, and Z directions for 8 minutes each	
Shock resistance		1,000 m/s <sup>2</sup> in X, Y, and Z directions 3 times each (18 times in total)	500 m/s <sup>2</sup> in X, Y, and Z directions 3 times each (18 times in total)	
Appearance		M12 × 35 mm	M22 × 65 mm	
Materials		ABS, brass, epoxy resin filling		
Weight		Approx. 55 g (with 2-m cable)	Approx. 850 g (with 12.5-m cable)	

**Note:** For details, refer to the User's Manual (Cat. No. Z248 or Z262).

\*1. The degree of protection for the Connector is IP67/IP65. This OMRON in-house standard confirms resistance to cutting and other oils. It is equivalent to the former JEM1030 standard.

\*2. The Connector is not waterproof. This OMRON in-house standard confirms resistance to cutting and other oils. It is equivalent to the former JEM1030 standard.

**Square Antenna (Detachable Amplifier Unit Type)**

Item	Model	V680-HS63-W (Standard Cable, Waterproof Connector)	V680-HS63-R (Flexible Cable, Non-waterproof Connector)
Ambient operating temperature		-10°C to 60°C (with no icing)	
Ambient storage temperature		-25°C to 75°C (with no icing)	
Ambient operating humidity		35% to 95% (with no condensation)	
Insulation resistance		20 MΩ min. (at 500 VDC) between the cable terminals and the case	
Dielectric strength		1,000 VAC (50/60 Hz) for 1 minute between the cable terminals and the case with a current leakage of 5 mA max.	
Degree of protection		IP67 (IEC60529) In-house standard for antenna oil resistance (former JEM1030 standard equivalent to IP67g) (Antenna portion) *1	IP67 (IEC60529) In-house standard for antenna oil resistance (former JEM1030 standard equivalent to IP67g) (Antenna portion) *2
Vibration resistance		10 to 500 Hz variable vibration, 1.5-mm double amplitude at 100 m/s <sup>2</sup> acceleration, with 10 sweeps in X, Y, and Z directions for 11 minutes each	
Shock resistance		500 m/s <sup>2</sup> in X, Y, and Z directions 3 times each (18 times in total)	
Appearance		40 × 53 × 23 mm	
Materials		ABS, epoxy resin filling	
Weight		Approx. 850 g (with 12.5-m cable)	

Item	Model	V680-HS65-W (Standard Cable, Waterproof Connector)	V680-HS65-R (Flexible Cable, Non-waterproof Connector)
Ambient operating temperature		-25°C to 70°C (with no icing)	
Ambient storage temperature		-40°C to 85°C (with no icing)	
Ambient operating humidity		35% to 95% (with no condensation)	
Insulation resistance		20 MΩ min. (at 500 VDC) between the cable terminals and the case	
Dielectric strength		1,000 VAC (50/60 Hz) for 1 minute between the cable terminals and the case with a current leakage of 5 mA max.	
Degree of protection		IP67 (IEC 60529) In-house standard for antenna oil resistance (former JEM1030 standard equivalent to IP67g) (Antenna portion) *1	IP67 (IEC 60529) In-house standard for antenna oil resistance (former JEM1030 standard equivalent to IP67g) (Antenna portion) *2
Vibration resistance		10 to 500 Hz variable vibration, 1.5-mm double amplitude at 100 m/s <sup>2</sup> acceleration, with 10 sweeps in X, Y, and Z directions for 11 minutes each	
Shock resistance		500 m/s <sup>2</sup> in X, Y, and Z directions 3 times each (18 times in total)	
Appearance		100 × 100 × 30 mm	
Materials		ABS, epoxy resin filling	
Weight		Approx. 1,100 g (with 12.5-m cable)	

**Note:** For details, refer to the User's Manual (Cat. No. Z248 or Z262).

\*1. The degree of protection for the Connector is IP67/IP65. This OMRON in-house standard confirms resistance to cutting and other oils. It is equivalent to the former JEM1030 standard.

\*2. The Connector is not waterproof. This OMRON in-house standard confirms resistance to cutting and other oils. It is equivalent to the former JEM1030 standard.



## Square Antenna with Built-in Amplifier

Item	Model	V680-H01-V2
Ambient operating temperature		-10°C to 55°C (with no icing)
Ambient storage temperature		-35°C to 65°C (with no icing)
Ambient operating humidity		35% to 85% (with no condensation)
Insulation resistance		20 MΩ min. (at 100 VDC) between the back plate and the case
Dielectric strength		1,000 VAC (50/60 Hz) for 1 minute between the back plate and the case with a current leakage of 1 mA max.
Degree of protection		IEC 60529: IP63 (Mounting direction: Transmission surface facing up)
Vibration resistance		10 to 150 Hz variable vibration, 0.7-mm double amplitude and 50 m/s <sup>2</sup> acceleration with 10 sweeps in X, Y, and Z directions for 8 minutes each
Shock resistance		150 m/s <sup>2</sup> in X, Y, and Z directions 3 times each
Appearance		200 × 250 × 40 mm
Material		Polycarbonate (PC) resin, ASA resin / Rear Panel: Aluminum
Weight		Approx. 900 g
Cable length		0.5 m

Note: For details, refer to the User's Manual (Cat. No. Z248 or Z262).

## Amplifier Unit

Item	Model	V680-HA63A	V680-HA63B
Ambient operating temperature		-10°C to 55°C (with no icing)	
Ambient storage temperature		-25°C to 65°C (with no icing)	
Ambient operating humidity		35% to 85% (with no condensation)	
Insulation resistance		20 MΩ min. (at 500 VDC) between the cable terminals and the case	
Dielectric strength		1,000 VAC (50/60 Hz) for 1 minute between the cable terminals and the case with a current leakage of 5 mA max.	
Degree of protection		IP40 (IEC60529) *1	IP67/IP65 (IEC60529) *2
Vibration resistance		10 to 500 Hz variable vibration, 1.5-mm double amplitude at 100 m/s <sup>2</sup> acceleration, with 10 sweeps in X, Y, and Z directions for 11 minutes each	
Shock resistance		500 m/s <sup>2</sup> in X, Y, and Z directions 3 times each (18 times in total)	
Appearance		25 × 40 × 65mm (not including projections)	
Material		Polycarbonate (PC) resin	
Weight		Approx. 650 g (with 10-m cable)	
Cable length		5 m, 10 m	
Transmittable RF Tags		1-kbyte memory	2-, 8-, 32-kbyte memory

Note: For details, refer to the User's Manual (Cat. No. Z248 or Z262).

\*1. When connected to the V680-HS□□-R or V680-HS52-R.

\*2. When connected to the V680-HS□□-W or V680-HS52-W. (Not including the Connector on the Controller.)

## ID Controller

Item	Model	V680-CA5D01-V2	V680-CA5D02-V2
Power supply voltage (Power consumption)		24 VDC (-15% to +10%) 15 W max., 0.8 A max.	
Communications Specifications		RS-232C, RS-422, RS-485	
Input Specifications (Input voltage) RST, TRG1, and TRG2		24 VDC (+10% to -15%, including ripple) (PNP and NPN compatible)	
Output Specifications (Maximum switching capacity) RUN, BUSY/OUT3, ERROR/OUT4, OUT1, and OUT2		24 VDC (+10% to -15%, including ripple) PNP and NPN compatible	
Ambient operating temperature		-10 to 55°C (with no icing)	
Ambient storage temperature		-25 to 65°C (with no icing)	
Ambient operating humidity		25% to 85% (with no condensation)	
Insulation resistance		20 MΩ min. (at 500 VDC) applied as follows: (1) Between power supply terminals and grounded case (2) Between ground and terminals	
Dielectric strength		1,000 VAC (50/60 Hz) for 1 minute (1) Between power supply terminals and grounded case (2) Between ground and terminals	
Degree of protection		Panel mounted (equivalent to IP20)	
Vibration resistance		10 to 150 Hz variable vibration, 0.2-mm double amplitude at 15 m/s <sup>2</sup> acceleration, with 10 sweeps in X, Y, and Z directions for 8 minutes each	
Shock resistance		150 m/s <sup>2</sup>	
Appearance		105 × 90 × 65 mm (not including projections)	
Material		Polycarbonate (PC) resin, ABS resin	
Weight		Approx. 300 g	
Connectable Amplifier Units		1	2

Note: For details, refer to the User's Manual (Cat. No. Z249).

## USB Port

The USB port is used for a simple connection with a personal computer using a USB cable. The port complies with USB 1.1, and the USB cable uses a series A or series mini-B connector. A USB port driver must be separately provided. Consult with your OMRON representative for details. When connected to a host device via USB, the communications will use 1:1 protocol regardless of the setting of DIP switches 3 to 9. The USB port is not used for control purposes. When building a system, be sure to provide an RS-232C port or RS-422/RS-485C port.

## ID Sensor Units

Item	Model	CJ1W-V680C11	CJ1W-V680C12	CS1W-V680C11	CS1W-V680C12
Current consumption	Internal: 5 V	260 mA	320 mA	260 mA	320 mA
	Internal: 24 V/26 V	130 mA *	260 mA	125 mA *	–
	External: 24 V	–	–	–	360 mA
Ambient operating temperature	0 to 55°C				
Ambient storage temperature	–20°C to 75°C				
Ambient operating humidity	10% to 90% (with no condensation)				
Insulation resistance	20 mΩ min. at 500 VDC				
Dielectric strength	1,000 VAC for 1 minute				
Degree of protection	Mounted in panel (IP30)				
Vibration resistance	10 to 57 Hz variable vibration, 0.075-mm double amplitude and 57 to 150 Hz variable vibration at 9.8 m/s <sup>2</sup> acceleration, with 10 sweeps in X, Y, and Z directions for 8 minutes each				
Shock resistance	147 m/s <sup>2</sup> in X, Y, and Z directions 3 times each				
Appearance	31 × 65 × 90 mm (excluding protrusions)			35 × 130 × 101 mm (excluding protrusions)	

\* When connected to the V680-H01: 280 mA. The V680-H01-V2 can be connected only to a 1-channel ID Sensor Unit. A 2-channel Unit cannot be used.

## Functional Specifications of ID Sensor Units

Item	Model	CJ1W-V680C11	CJ1W-V680C12	CS1W-V680C11	CS1W-V680C12
Communications control protocol	Special protocol for CS, CJ and NJ PLCs				
Number of Antenna connections	1	2	1	2	
Commands	Supported commands: Read, Write, Bit Set/Bit Clear, Mask Bit Write, Calculation Write, Data Fill, Data Check, Number of Writes Control, Copy (CJ1W-V680C12 and CS1W-V680C12 only), Read with Error Correction/Write with Error Correction, UID Read, and Noise Measurement. The following communications options are supported: Single trigger, Single auto, Repeat auto, FIFO trigger, FIFO repeat *, Multi-access trigger, and Multi-access repeat *				
Data transfer quantity	2,048 bytes max. (160 bytes/scan)				
Diagnostic function	(1) CPU watchdog timer (2) Communications error detection with RF Tag (3) Antenna power supply error				
Monitoring/testing functions	Tag communications can be tested in Test Mode. Status is displayed by LED indicators.				
Number of allocated words	10 words	20 words	10 words	20 words	

**Note:** For details, refer to the User's Manual (Cat. No. Z271).

\* Cannot be used for communications with the V680-D1KP□□.

**Amplifier-integrated Controller (DeviceNet ID Slave/PROFIBUS ID Slave)**

Item	Model	V680-HAM42-DRT	V680-HAM42-PRT
Network compatibility		DeviceNet	PROFIBUS DP-V0
Connectable Antennas		One channel (V680-HS□□)	
Rated voltage		24 VDC (–15% to 10%) including 10% ripple (p-p)	
Power consumption		4 W max. (Current consumption of 200 mA max. at power supply voltage of 24 VDC)	
Ambient operating temperature		–10 to 55°C (with no icing)	
Ambient storage temperature		–25 to 65°C (with no icing)	
Ambient operating humidity		25% to 85% (with no condensation; ambient operating temperature is 40°C max. at humidity of 85%)	
Insulation resistance		20 MΩ min. (at 500 VDC) between all terminals excluding the ground terminal and the case	
Dielectric strength		1,000 VAC (50/60 Hz) for 1 minute between all terminals excluding the ground terminal and the case	
Vibration resistance		10 to 150 Hz, 0.2-mm double amplitude at 15 m/s <sup>2</sup> acceleration with 10 sweeps in X, Y and Z directions for 8 minutes each	
Shock resistance		150 m/s <sup>2</sup> in X, Y, and Z directions 3 times each (18 times in total)	
Appearance		65 × 65 × 65 mm (excluding protrusions)	
Degree of protection		IEC 60529, IP20	
Materials		Polycarbonate (PC) resin, ABS resin	
Weight		Approx. 150 g	
Mounting		DIN Track	

**Note: 1.** For details, refer to the *User's Manual* (Cat. No. Z278).

**2.** The number of words allocated in the master depends on the Access Mode.

**Amplifier-integrated Controllers (ID Flag Sensors)**

Item	Model	V680-HAM91	V680-HAM81
Rated voltage		24 VDC (–15% to +10%) including 10% ripple (p-p)	
Power consumption		3.5 W (24 VDC, 150 mA max. except external I/O line current)	
Input specifications		Transistor output Short-circuit current: 3 mA (typical) (for short-circuit between IN terminal and 0 V), OFF voltage: 15 to 30 VDC, ON voltage: 0 to 5 VDC, Input impedance: 8.2 kΩ, Applied voltage: 30 VDC max.	
Output specifications		NPN open-collector output 30 VDC, 20 mA max., Residual voltage: 2 V max.	PNP open-collector output 30 VDC, 20 mA max., Residual voltage: 2 V max.
Ambient operating temperature		–10 to 55°C (with no icing)	
Ambient storage temperature		–25 to 65°C (with no icing)	
Ambient operating humidity		25% to 85% (with no condensation; ambient operating temperature is 40°C max. at humidity of 85%)	
Insulation resistance		20 MΩ min. (at 500 VDC) between all terminals excluding the FG terminal and the case	
Dielectric strength		1,000 VAC (50/60 Hz) applied for 1 minute between all terminals excluding the FG terminal and the case	
Vibration resistance		10 to 150 Hz, 0.2-mm double amplitude at 15 m/s <sup>2</sup> acceleration with 10 sweeps in X, Y and Z directions for 8 minutes each	
Shock resistance		150 m/s <sup>2</sup> in X, Y, and Z directions 3 times each (18 times in total)	
Appearance		90 × 30 × 65 mm (excluding protrusions)	
Degree of protection		IEC 60529, IP40	
Materials		Polycarbonate (PC) resin, ABS resin	
Weight		Approx. 130 g	
Mounting		DIN Track	

**Note: 1.** For details, refer to the *User's Manual* (Cat. No. Z279).

**2.** The connectors are not water resistant. If there is a possibility that water will be splashed onto the ID Sensor Unit, mount it inside of a control box. Also, be sure to use the V680 as a set with the V680-A60 Interface Cable (sold separately).

## Handheld Reader Writers

Item	Model	V680-CHUD 0.8M	V680-CHUD 1.9M	V680-CH1D	V680-CH1D-PSI
Power supply voltage		5 VDC $\pm$ 5% (at the connector section of the product)			
Current consumption		500 mA max. (for a power supply voltage of 5.0 V)			
Communications specifications		USB (Series A plug) Ver.1.1		RS-232C (D-SUB 9-pin) compatible with IBM PC/AT)	RS-232C (D-SUB 9-pin)
Ambient operating temperature during communication		0 to +40°C			
Ambient storage temperature		-25 to +65°C			
Ambient operating humidity during communication		35% to 85% (with no condensation)			
Insulation resistance		50 M $\Omega$ min. (at 500 VDC) between connector and case			
Dielectric strength		1,000 VAC, 50/60 Hz for 1 min (leakage current: 1 mA max.) between connectors and case			
Degree of protection		IEC 60529: IP63 *			
Vibration resistance		Destruction: 10 to 150 Hz variable vibration, 0.2-mm double amplitude and 15 m/s <sup>2</sup> acceleration with 10 sweeps for 8 min each in 6 directions			
Shock resistance		Destruction: 150 m/s <sup>2</sup> , 3 times each in X, Y, and Z directions			
Weight		Approx. 110 g (including connector and cable)	Approx. 140 g (including connector and cable)	Approx. 170 g (including connector and cable)	Approx. 120 g (including connector and cable)
Cable length		0.8 m	1.9 m	2.5 m	0.8 m

**Note:** Refer to the User's Manual (Cat. No. Z272) for details.

Contact your OMRON sales representative for details on drivers for Windows.













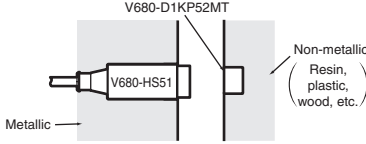

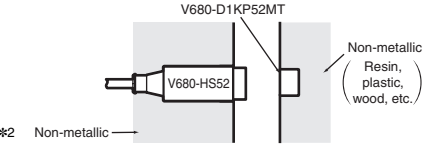

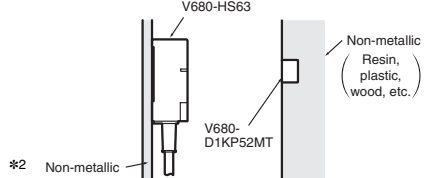

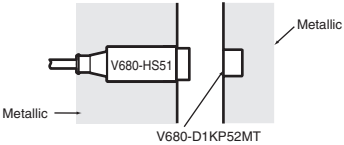
\* This does not include the connector section. The main unit is not resistant to chemical or oils.

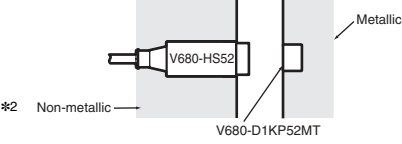
## AC Adapter (for V680-CH1D)

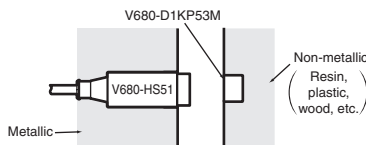
Item	Model	V600-A22
Input voltage		100 to 120 VAC at 50/60 Hz
Input current		AC: 300 mA (at load current of 2.0 A)
Output voltage		DC5V $\pm$ 0.25V
Ambient operating temperature		0 to +40°C
Ambient storage temperature		-20 to +85°C (with no icing)
Ambient operating humidity		5% to 95% (with no condensation)
Insulation resistance		100 M $\Omega$ min. (at 500 VDC) between input terminals and output terminals
Dielectric strength		2,000 V for 1 minute between input terminals and output terminals with a current leakage of 10 mA max.
Weight		Approx. 70 g
Applicable standards		UL

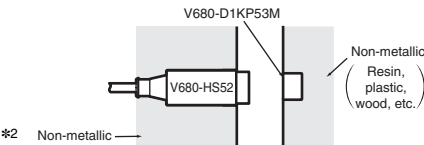

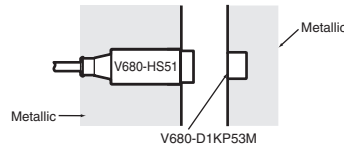

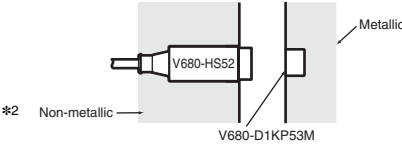







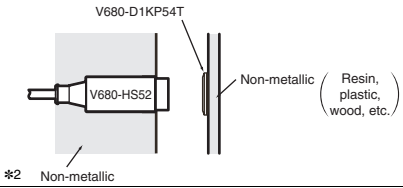

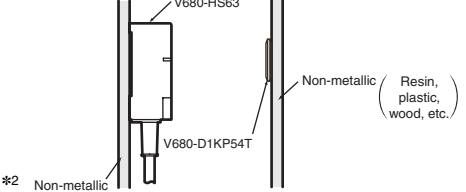
## Communication Specifications

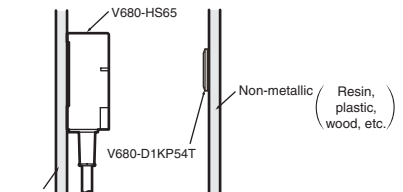
### ID Controllers (V680-CA5D01-V2/V680-CA5D02-V2) RF Tag (1-kbyte Memory) Transmission

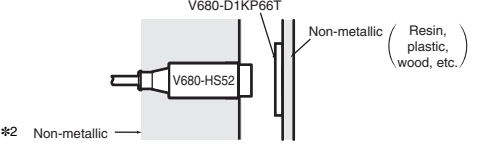
Recommended combination		Function	Transmission distance (unit: mm)	RF Tag and Antenna mounting conditions
RF Tag	Antenna			
	<b>V680-HS51</b> 	Read distance	0.5 to 6.5 (axial deviation ±2)	
		Write distance	0.5 to 6.0 (axial deviation ±2)	
	<b>V680-HS52</b> 	Read distance	0 to 9.0 (axial deviation ±2)	
		Write distance	0 to 8.5 (axial deviation ±2)	
	<b>V680-HS63</b> 	Read distance	0 to 12.0 (axial deviation ±2)	
		Write distance	0 to 9.5 (axial deviation ±2)	
<b>V680-D1KP52MT</b> (embedded in metallic surface: steel) 	<b>V680-HS51</b> 	Read distance	0.5 to 3.5 *1 (axial deviation ±2)	
		Write distance	0.5 to 3.0 *1 (axial deviation ±2)	
	<b>V680-HS52</b> 	Read distance	0 to 4.5 *1 (axial deviation ±2)	
		Write distance	0 to 4.0 *1 (axial deviation ±2)	
<b>V680-D1KP53M</b> 	<b>V680-HS51</b> 	Read distance	0.5 to 6.5 (axial deviation ±2)	
		Write distance	0.5 to 6.0 (axial deviation ±2)	
	<b>V680-HS52</b> 	Read distance	0 to 9.0 (axial deviation ±2)	
		Write distance	0 to 8.5 (axial deviation ±2)	
<b>V680-D1KP53M</b> (embedded in metallic surface : steel) 	<b>V680-HS51</b> 	Read distance	0.5 to 3.5 *1 (axial deviation ±2)	
		Write distance	0.5 to 3.0 *1 (axial deviation ±2)	
	<b>V680-HS52</b> 	Read distance	0 to 4.5 *1 (axial deviation ±2)	
		Write distance	0 to 4.0 *1 (axial deviation ±2)	

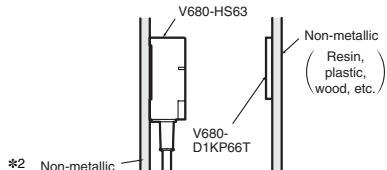
\*1. When using the V680-D1KP52MT/-D1KP53M embedded in metal, use the V680-HS51/-HS52 Antenna. Communications will not be possible with a V680-HS63 Antenna.

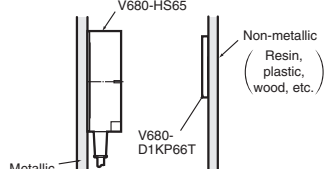

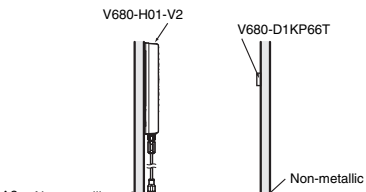





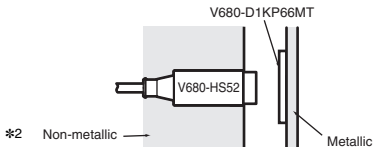

\*2. The Antenna can be mounted in metal, but the communications distance will decrease compared to mounting in nonmetal. Confirm performance using the actual devices before actual operation.

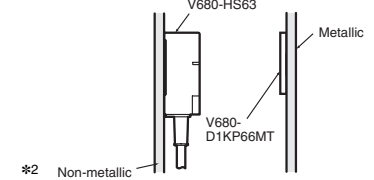
Recommended combination		Function	Transmission distance (unit: mm)	RF Tag and Antenna mounting conditions
RF Tag	Antenna			
<b>V680-D1KP54T</b>  	<b>V680-HS52</b> 	Read distance	0 to 17.0 *1 (axial deviation ±2)	
		Write distance	0 to 15.0 *1 (axial deviation ±2)	
	<b>V680-HS63</b> 	Read distance	0 to 24.0 *1 (axial deviation ±10)	
		Write distance	0 to 20.0 *1 (axial deviation ±10)	
	<b>V680-HS65</b> 	Read distance	0 to 33.0 *1 (axial deviation ±10)	
		Write distance	0 to 28.0 *1 (axial deviation ±10)	
<b>V680-D1KP66T</b>  	<b>V680-HS52</b> 	Read distance	0 to 17.0 *1 (axial deviation ±2)	
		Write distance	0 to 17.0 *1 (axial deviation ±2)	
	<b>V680-HS63</b> 	Read distance	0 to 30.0 *1 (axial deviation ±10)	
		Write distance	0 to 25.0 *1 (axial deviation ±10)	
	<b>V680-HS65</b> 	Read distance	0 to 47.0 *1 (axial deviation ±10)	
		Write distance	0 to 42.0 *1 (axial deviation ±10)	
	<b>V680-H01-V2</b> 	Read distance	0 to 100.0 *1 (axial deviation ±2)	
		Write distance	0 to 100.0 *1 (axial deviation ±2)	

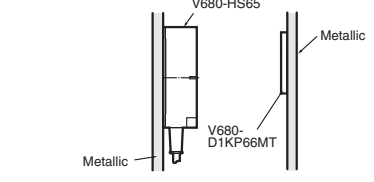
**Note:** When mounting the V680-HS65, be sure to attach the Mounting Brackets at the base of the Antenna. The enclosed Mounting Brackets do not need to be used, however, if the mounting brackets on the Antenna are metal plates and their dimensions are larger than the dimensions of the Antenna (100 × 100 mm). For details, refer to the User's Manual (Cat. No. Z248 or Z262).

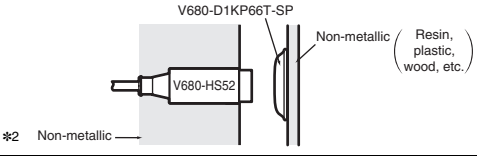
\*1. The transmission distance may be reduced if the V680-D1KP66T/-D1KP54T is mounted onto a metallic surface. Refer to the User's Manual (Cat. No. Z262) for details.

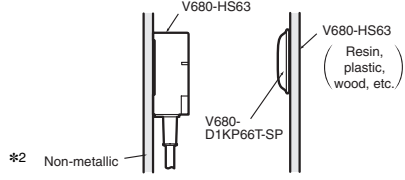
\*2. The Antenna can be mounted in metal, but the communications distance will decrease compared to mounting in nonmetal. Confirm performance using the actual devices before actual operation.

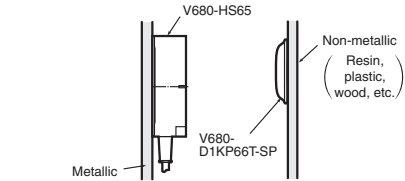
Recommended combination		Function	Transmission distance (unit: mm)	RF Tag and Antenna mounting conditions	
RF Tag	Antenna				
<b>V680-D1KP66MT</b> (flush-mounted on metallic surface: steel)	<b>V680-HS52</b> 	Read distance	0 to 16.0 (axial deviation ±2)		
		Write distance	0 to 14.0 (axial deviation ±2)		
		<b>V680-HS63</b> 	Read distance	0 to 25.0 (axial deviation ±10)	
			Write distance	0 to 20.0 (axial deviation ±10)	
		<b>V680-HS65</b> 	Read distance	0 to 25.0 (axial deviation ±10)	
			Write distance	0 to 20.0 (axial deviation ±10)	
<b>V680-D1KP66T-SP</b>	<b>V680-HS52</b> 	Read distance	0 to 15.0 *1 (axial deviation ±2)		
		Write distance	0 to 15.0 *1 (axial deviation ±2)		
		<b>V680-HS63</b> 	Read distance	0 to 25.0 *1 (axial deviation ±10)	
			Write distance	0 to 20.0 *1 (axial deviation ±10)	
		<b>V680-HS65</b> 	Read distance	0 to 42.0 *1 (axial deviation ±10)	
			Write distance	0 to 37.0 *1 (axial deviation ±10)	

**Note:** When mounting the V680-HS65, be sure to attach the Mounting Brackets at the base of the Antenna.  
 The enclosed Mounting Brackets do not need to be used, however, if the mounting brackets on the Antenna are metal plates and their dimensions are larger than the dimensions of the Antenna (100 × 100 mm).  
 For details, refer to the User's Manual (Cat. No. Z248 or Z262).

\*1. The transmission distance may be reduced if the V680-D1KP66T-SP is mounted onto a metallic surface. Refer to the User's Manual (Cat. No. Z262) for details.

\*2. The Antenna can be mounted in metal, but the communications distance will decrease compared to mounting in nonmetal. Confirm performance using the actual devices before actual operation.

## High-temperature RF Tag (1-kbyte Memory) Transmission

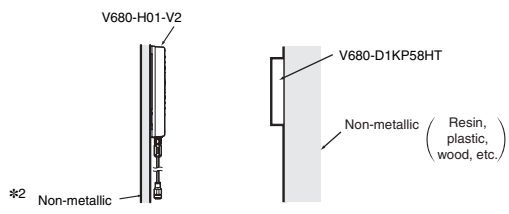











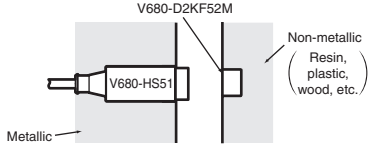

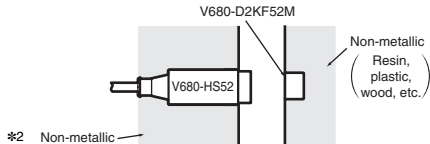

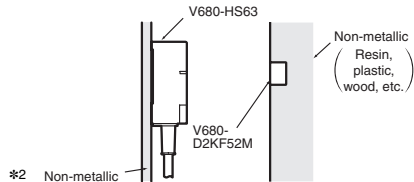

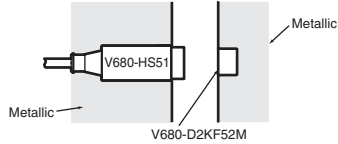
Recommended combination		Function	Transmission distance (unit: mm)	RF Tag and Antenna mounting conditions
RF Tag	Antenna			
<b>V680-D1KP58HT</b>	<b>V680-H01-V2</b> 	Read distance  Write distance	0 to 150.0 *1 (axial deviation ±10)	

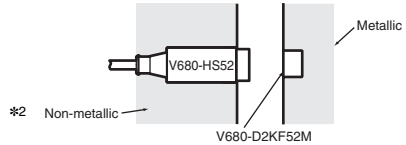
\*1. The transmission distance may be reduced if the V680-D1KP58HT is mounted onto a metallic surface. Refer to the User's Manual (Cat. No. Z262) for details.

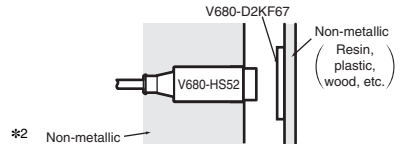
\*2. The Antenna can be mounted in metal, but the communications distance will decrease compared to mounting in nonmetal. Confirm performance using the actual devices before actual operation.

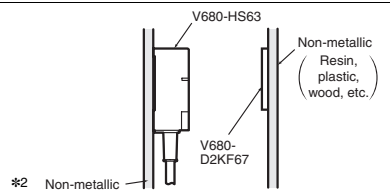

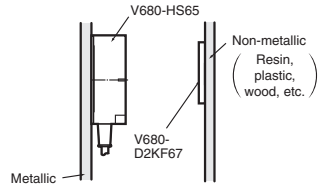
## RF Tag (2-kbyte Memory) Transmission

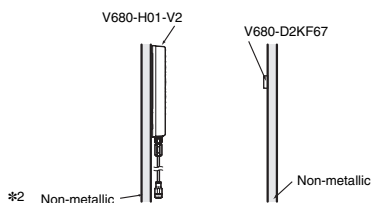
Recommended combination		Function	Transmission distance (unit: mm)	RF Tag and Antenna mounting conditions
RF Tag	Antenna			
	<b>V680-HS51</b> 	Read distance	0.5 to 5.5 (axial deviation $\pm 2$ )	
		Write distance	0.5 to 5.5 (axial deviation $\pm 2$ )	
	<b>V680-HS52</b> 	Read distance	0 to 8.0 (axial deviation $\pm 2$ )	
		Write distance	0 to 8.0 (axial deviation $\pm 2$ )	
	<b>V680-HS63</b> 	Read distance	0 to 9.5 (axial deviation $\pm 2$ )	
		Write distance	0 to 9.5 (axial deviation $\pm 2$ )	
<b>V680-D2KF52M</b> (embedded in metallic surface: steel) 	<b>V680-HS51</b> 	Read distance	0 to 3.5 (axial deviation $\pm 2$ )	
		Write distance	0 to 3.5 (axial deviation $\pm 2$ )	
	<b>V680-HS52</b> 	Read distance	0 to 3.0 (axial deviation $\pm 2$ )	
		Write distance	0 to 3.0 (axial deviation $\pm 2$ )	
<b>V680-D2KF67</b> 	<b>V680-HS52</b> 	Read distance	0 to 17.0 *1 (axial deviation $\pm 2$ )	
		Write distance	0 to 17.0 *1 (axial deviation $\pm 2$ )	
	<b>V680-HS63</b> 	Read distance	7 to 30.0 *1 (axial deviation $\pm 10$ )	
		Write distance	7 to 30.0 *1 (axial deviation $\pm 10$ )	
	<b>V680-HS65</b> 	Read distance	0 to 42.0 *1 (axial deviation $\pm 10$ )	
		Write distance	0 to 42.0 *1 (axial deviation $\pm 10$ )	
	<b>V680-H01-V2</b> 	Read distance	0 to 100.0 *1 (axial deviation $\pm 10$ )	
		Write distance	0 to 100.0 *1 (axial deviation $\pm 10$ )	

**Note:** When mounting the V680-HS65, be sure to attach the Mounting Brackets at the base of the Antenna.





The enclosed Mounting Brackets do not need to be used, however, if the mounting brackets on the Antenna are metal plates and their dimensions are larger than the dimensions of the Antenna (100 × 100 mm).

For details, refer to the User's Manual (Cat. No. Z248 or Z262).

\*1. The transmission distance may be reduced if the V680-D2KF67 is mounted onto a metallic surface. Refer to the User's Manual (Cat. No. Z248) for details.

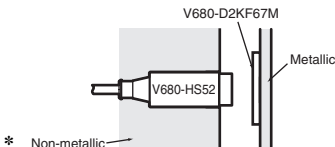
\*2. The Antenna can be mounted in metal, but the communications distance will decrease compared to mounting in nonmetal. Confirm performance using the actual devices before actual operation.

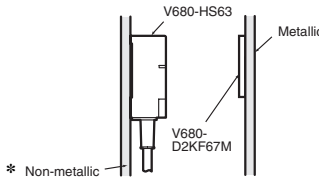

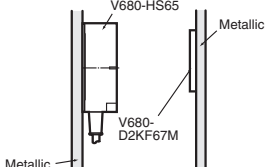





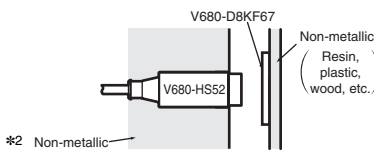

Recommended combination		Function	Transmission distance (unit: mm)	RF Tag and Antenna mounting conditions
RF Tag	Antenna			
<b>V680-D2KF67M</b> (flush-mounted on metallic surface: steel)	<b>V680-HS52</b> 	Read distance	0 to 16.0 (axial deviation ±2)	
		Write distance	0 to 16.0 (axial deviation ±2)	
	<b>V680-HS63</b> 	Read distance	6 to 25.0 (axial deviation ±10)	
		Write distance	6 to 25.0 (axial deviation ±10)	
	<b>V680-HS65</b> 	Read distance	0 to 25.0 (axial deviation ±10)	
		Write distance	0 to 25.0 (axial deviation ±10)	

**Note:** When mounting the V680-HS65, be sure to attach the Mounting Brackets at the base of the Antenna.  
 The enclosed Mounting Brackets do not need to be used, however, if the mounting brackets on the Antenna are metal plates and their dimensions are larger than the dimensions of the Antenna (100 × 100 mm).  
 For details, refer to the User's Manual (Cat. No. Z248 or Z262).

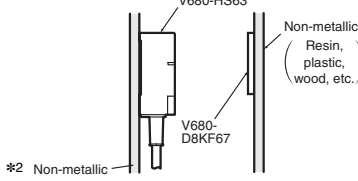
\* The Antenna can be mounted in metal, but the communications distance will decrease compared to mounting in nonmetal.  
 Confirm performance using the actual devices before actual operation.

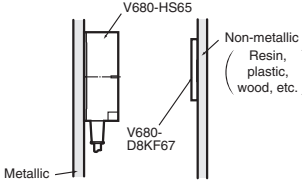

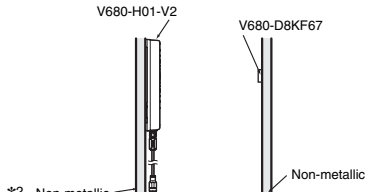







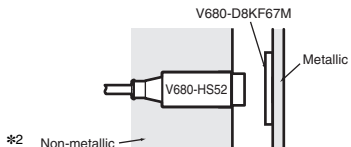

## RF Tag (8-/32-kbyte Memory) Transmission

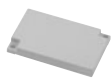
Recommended combination		Function	Transmission distance (unit: mm)	RF Tag and Antenna mounting conditions
RF Tag	Antenna			
<b>V680-D8KF67</b> 	<b>V680-HS52</b> 	Read distance	0 to 17.0 *1 (axial deviation ±2)	
		Write distance	0 to 17.0 *1 (axial deviation ±2)	
	<b>V680-HS63</b> 	Read distance	0 to 30.0 *1 (axial deviation ±10)	
		Write distance	0 to 30.0 *1 (axial deviation ±10)	
	<b>V680-HS65</b> 	Read distance	0 to 42.0 *1 (axial deviation ±10)	
		Write distance	0 to 42.0 *1 (axial deviation ±10)	
	<b>V680-H01-V2</b> 	Read distance	0 to 100.0 *1 (axial deviation ±10)	
		Write distance	0 to 100.0 *1 (axial deviation ±10)	

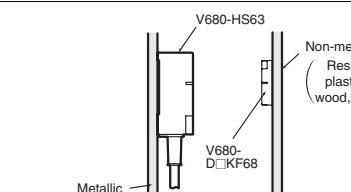
**Note:** When mounting the V680-HS65, be sure to attach the Mounting Brackets at the base of the Antenna.  
 The enclosed Mounting Brackets do not need to be used, however, if the mounting brackets on the Antenna are metal plates and their dimensions are larger than the dimensions of the Antenna (100 × 100 mm).  
 For details, refer to the User's Manual (Cat. No. Z248 or Z262).

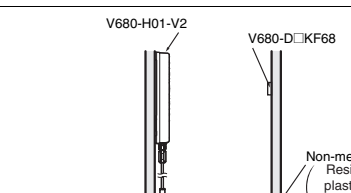
\*1. The communications distance will decrease if there is metal at the back of the V680-D8KF67.  
 For details, refer to the relative user's manual (Cat. No. Z248).

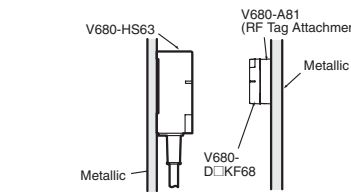
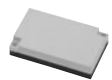
\*2. The Antenna can be mounted in metal, but the communications distance will decrease compared to mounting in nonmetal.  
 Confirm performance using the actual devices before actual operation.

Recommended combination		Function	Transmission distance (unit: mm)	RF Tag and Antenna mounting conditions
RF Tag	Antenna			
<b>V680-D8KF67M</b> (flush-mounted on metallic surface: steel)	<b>V680-HS52</b> 	Read distance	0 to 16.0 (axial deviation ±2)	
		Write distance	0 to 16.0 (axial deviation ±2)	
		<b>V680-HS63</b> 	Read distance	0 to 25.0 (axial deviation ±10)
		Write distance	0 to 25.0 (axial deviation ±10)	
		<b>V680-HS65</b> 	Read distance	0 to 25.0 (axial deviation ±10)
	Write distance	0 to 25.0 (axial deviation ±10)		
<b>V680-D8KF68/ -D32KF68</b> 	<b>V680-HS63</b> 	Read distance	0 to 45.0 *1 (axial deviation ±10)	
		Write distance	0 to 45.0 *1 (axial deviation ±10)	
		<b>V680-HS65</b> 	Read distance	0 to 75.0 *1 (axial deviation ±10)
	Write distance	0 to 75.0 *1 (axial deviation ±10)		
	<b>V680-H01-V2</b> 	Read distance	0 to 150.0 *1 (axial deviation ±10)	
	Write distance	0 to 150.0 *1 (axial deviation ±10)		
<b>V680-D8KF68/ -D32KF68</b> (Special attachment provided: flush-mounted on metallic surface: steel)	<b>V680-HS63</b> 	Read distance	0 to 35.0 (axial deviation ±10)	
		Write distance	0 to 35.0 (axial deviation ±10)	
		<b>V680-HS65</b> 	Read distance	0 to 55.0 (axial deviation ±10)
		Write distance	0 to 55.0 (axial deviation ±10)	

**Note:** When mounting the V680-HS65, be sure to attach the Mounting Brackets at the base of the Antenna.









The enclosed Mounting Brackets do not need to be used, however, if the mounting brackets on the Antenna are metal plates and their dimensions are larger than the dimensions of the Antenna (100 × 100 mm).

For details, refer to the User's Manual (Cat. No. Z248 or Z262).

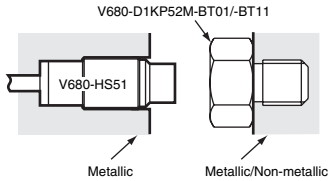
\*1. The transmission distance may be reduced if the V680-D8KF68 is mounted onto a metallic surface. Use V680-A81 special attachment. Refer to the User's Manual (Cat. No. Z248) for details.

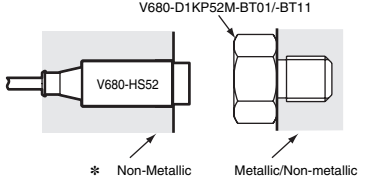

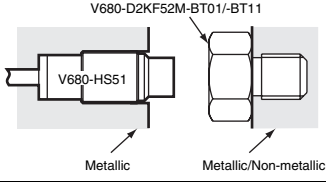

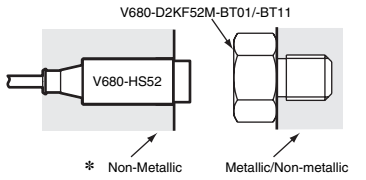







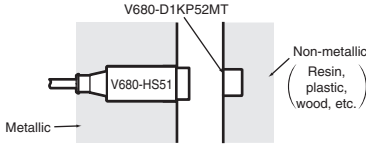

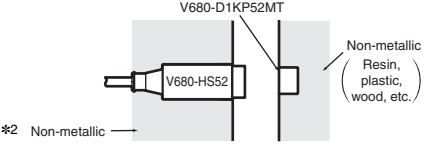

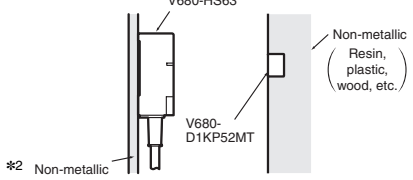

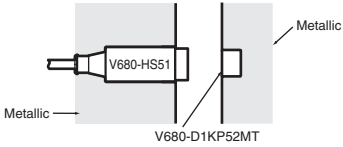
\*2. The Antenna can be mounted in metal, but the communications distance will decrease compared to mounting in nonmetal. Confirm performance using the actual devices before actual operation.

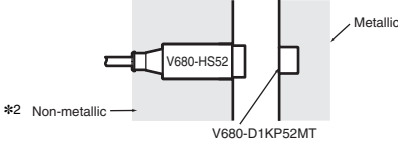

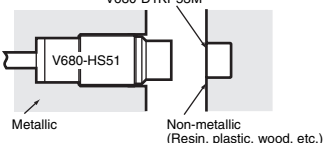

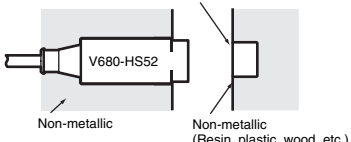

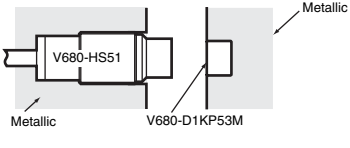
## Bolt RF Tag (1-kbyte or 2-kbyte Memory) Transmission

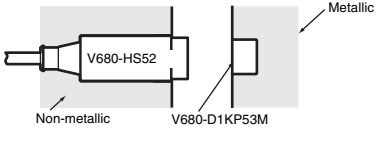
Recommended combination		Function	Transmission distance (unit: mm)	RF Tag and Antenna mounting conditions
RF Tag	Antenna			
<b>V680-D1KP52M-BT01/-BT11</b>  	<b>V680-HS51</b>  	Read distance	0.5 to 2.5 (axial deviation ±2)	
		Write distance	0.5 to 2.0 (axial deviation ±2)	
	<b>V680-HS52</b>  	Read distance	0.5 to 3.0 (axial deviation ±2)	
		Write distance	0.5 to 2.5 (axial deviation ±2)	
<b>V680-D2KF52M-BT01/-BT11</b>  	<b>V680-HS51</b>  	Read distance	0.5 to 2.5 (axial deviation ±2)	
		Write distance	0.5 to 2.5 (axial deviation ±2)	
	<b>V680-HS52</b>  	Read distance	0.5 to 2.0 (axial deviation ±2)	
		Write distance	0.5 to 2.0 (axial deviation ±2)	

\* Mounting can be performed in metal, but the communications distance will decrease compared to mounting in nonmetal. Confirm performance using the actual devices before actual operation.

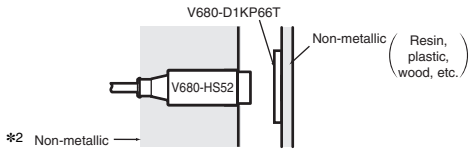
**DeviceNet ID Slave (V680-HAM42-DRT)  
 PROFIBUS ID Slave (V680-HAM42-PRT)  
 ID Flag Sensors (V680-HAM91/-HAM81)  
 RF Tag (1-kbyte Memory) Transmission**

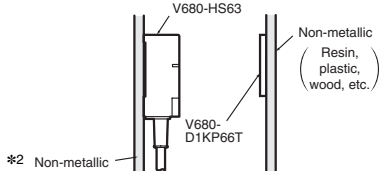
Recommended combination		Function	Transmission distance (unit: mm)	RF Tag and Antenna mounting conditions
RF Tag	Antenna			
	<b>V680-HS51</b> 	Read distance	0.5 to 6.5 (axial deviation ±2)	
		Write distance	0.5 to 6.0 (axial deviation ±2)	
	<b>V680-HS52</b> 	Read distance	0.5 to 9.0 (axial deviation ±2)	
		Write distance	0.5 to 8.5 (axial deviation ±2)	
	<b>V680-HS63</b> 	Read distance	0.5 to 12.0 (axial deviation ±2)	
		Write distance	0.5 to 9.5 (axial deviation ±2)	
<b>V680-D1KP52MT</b> (embedded in metallic surface: steel) 	<b>V680-HS51</b> 	Read distance	0.5 to 3.5 (axial deviation ±2)	
		Write distance	0.5 to 3.0 (axial deviation ±2)	
	<b>V680-HS52</b> 	Read distance	0.5 to 4.5 (axial deviation ±2)	
		Write distance	0.5 to 4.0 (axial deviation ±2)	
<b>V680-D1KP53M</b> 	<b>V680-HS51</b> 	Read distance	0.5 to 6.5 (axial deviation ±2)	
		Write distance	0.5 to 6.0 (axial deviation ±2)	
	<b>V680-HS52</b> 	Read distance	0.5 to 9.0 (axial deviation ±2)	
		Write distance	0.5 to 8.5 (axial deviation ±2)	
<b>V680-D1KP53M</b> (embedded in metallic surface : steel) 	<b>V680-HS51</b> 	Read distance	0.5 to 3.5 (axial deviation ±2)	
		Write distance	0.5 to 3.0 (axial deviation ±2)	
	<b>V680-HS52</b> 	Read distance	0.5 to 4.5 (axial deviation ±2)	
		Write distance	0.5 to 4.0 (axial deviation ±2)	

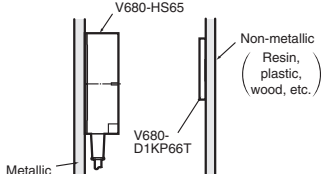
Recommended combination		Function	Transmission distance (unit: mm)	RF Tag and Antenna mounting conditions
RF Tag	Antenna			
<b>V680-D1KP66T</b>  	<b>V680-HS52</b> 	Read distance	1.0 to 17.0 *1 (axial deviation ±2)	
		Write distance	1.0 to 17.0 *1 (axial deviation ±2)	
	<b>V680-HS63</b> 	Read distance	5.0 to 30.0 *1 (axial deviation ±10)	
		Write distance	5.0 to 25.0 *1 (axial deviation ±10)	
	<b>V680-HS65</b> 	Read distance	5.0 to 47.0 *1 (axial deviation ±10)	
		Write distance	5.0 to 42.0 *1 (axial deviation ±10)	









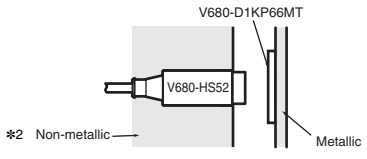

**Note:** When mounting the V680-HS65, be sure to attach the Mounting Brackets at the base of the Antenna.

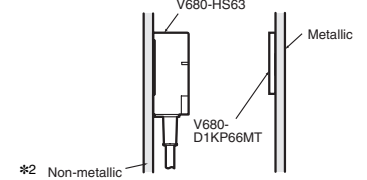
The enclosed Mounting Brackets do not need to be used, however, if the mounting brackets on the Antenna are metal plates and their dimensions are larger than the dimensions of the Antenna (100 × 100 mm).

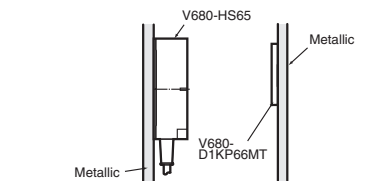
For details, refer to the User's Manual (Cat. No. Z278 or Z279).

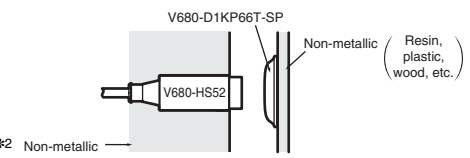
\*1. The transmission distance may be reduced if the V680-D1KP66T is mounted onto a metallic surface. Refer to the User's Manual (Cat. No. Z278 or Z279) for details.

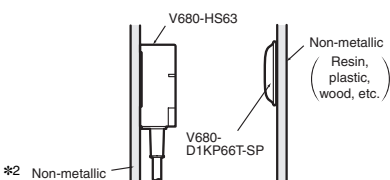
\*2. The Antenna can be mounted in metal, but the communications distance will decrease compared to mounting in nonmetal.

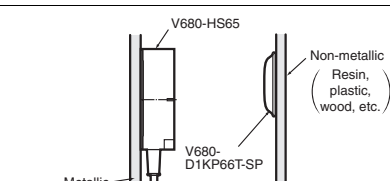
Recommended combination		Function	Transmission distance (unit: mm)	RF Tag and Antenna mounting conditions	
RF Tag	Antenna				
<b>V680-D1KP66MT</b> (flush-mounted on metallic surface: steel)	<b>V680-HS52</b> 	Read distance	1.0 to 16.0 (axial deviation ±2)		
		Write distance	1.0 to 14.0 (axial deviation ±2)		
		<b>V680-HS63</b> 	Read distance	5.0 to 25.0 (axial deviation ±2)	
			Write distance	5.0 to 20.0 (axial deviation ±2)	
		<b>V680-HS65</b> 	Read distance	5.0 to 25.0 (axial deviation ±10)	
			Write distance	5.0 to 20.0 (axial deviation ±10)	
<b>V680-D1KP66T-SP</b>	<b>V680-HS52</b> 	Read distance	1.0 to 15.0 *1 (axial deviation ±2)		
		Write distance	1.0 to 15.0 *1 (axial deviation ±2)		
		<b>V680-HS63</b> 	Read distance	5.0 to 25.0 *1 (axial deviation ±10)	
			Write distance	5.0 to 20.0 *1 (axial deviation ±10)	
		<b>V680-HS65</b> 	Read distance	5.0 to 42.0 *1 (axial deviation ±10)	
			Write distance	5.0 to 37.0 *1 (axial deviation ±10)	

**Note:** When mounting the V680-HS65, be sure to attach the Mounting Brackets at the base of the Antenna.













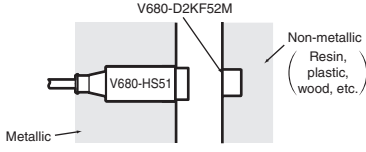

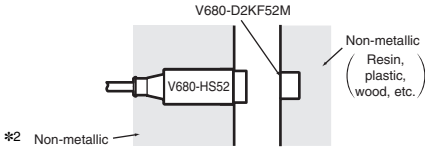

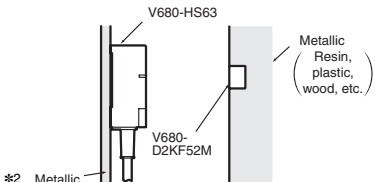
The enclosed Mounting Brackets do not need to be used, however, if the mounting brackets on the Antenna are metal plates and their dimensions are larger than the dimensions of the Antenna (100 × 100 mm).

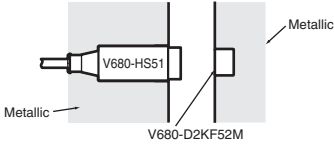
For details, refer to the User's Manual (Cat. No. Z278 or Z279).

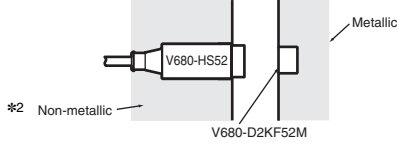
\*1. The transmission distance may be reduced if the V680-D1KP66T-SP is mounted onto a metallic surface. Refer to the User's Manual (Cat. No. Z278 or Z279) for details.

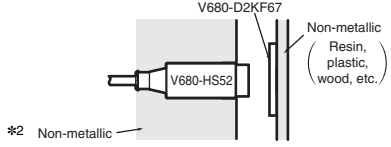
\*2. The Antenna can be mounted in metal, but the communications distance will decrease compared to mounting in nonmetal. Confirm performance using the actual devices before actual operation.

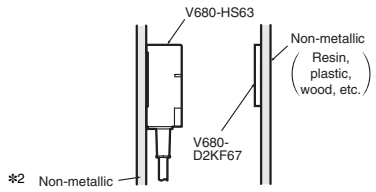
## RF Tag (2-kbyte Memory) Transmission

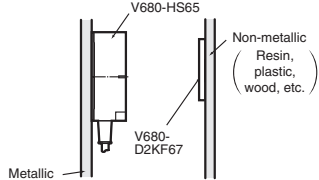
Recommended combination		Function	Transmission distance (unit: mm)	RF Tag and Antenna mounting conditions
RF Tag	Antenna			
<b>V680-D2KF52M</b>  	<b>V680-HS51</b>  	Read distance	0.5 to 5.5 (axial deviation ±2)	
		Write distance	0.5 to 5.5 (axial deviation ±2)	
	<b>V680-HS52</b>  	Read distance	0.5 to 8.0 (axial deviation ±2)	
		Write distance	0.5 to 8.0 (axial deviation ±2)	
	<b>V680-HS63</b>  	Read distance	0.5 to 9.5 (axial deviation ±2)	
		Write distance	0.5 to 9.5 (axial deviation ±2)	
<b>V680-D2KF52M</b> (embedded in metallic surface: steel)  	<b>V680-HS51</b>  	Read distance	0.5 to 3.5 (axial deviation ±2)	
		Write distance	0.5 to 3.5 (axial deviation ±2)	
	<b>V680-HS52</b>  	Read distance	0.5 to 3.0 (axial deviation ±2)	
		Write distance	0.5 to 3.0 (axial deviation ±2)	
<b>V680-D2KF67</b>  	<b>V680-HS52</b>  	Read distance	1.0 to 17.0 *1 (axial deviation ±2)	
		Write distance	1.0 to 17.0 *1 (axial deviation ±2)	
	<b>V680-HS63</b>  	Read distance	7.0 to 30.0 *1 (axial deviation ±10)	
		Write distance	7.0 to 30.0 *1 (axial deviation ±10)	
	<b>V680-HS65</b>  	Read distance	5.0 to 42.0 *1 (axial deviation ±10)	
		Write distance	5.0 to 42.0 *1 (axial deviation ±10)	

**Note:** When mounting the V680-HS65, be sure to attach the Mounting Brackets at the base of the Antenna.







The enclosed Mounting Brackets do not need to be used, however, if the mounting brackets on the Antenna are metal plates and their dimensions are larger than the dimensions of the Antenna (100 × 100 mm).

For details, refer to the User's Manual (Cat. No. Z278 or Z279).

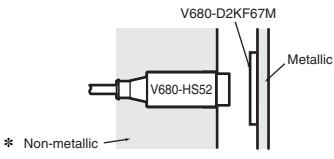
\*1. The transmission distance may be reduced if the V680-D2KF67 is mounted onto a metallic surface. Refer to the User's Manual (Cat. No. Z278 or Z279) for details.

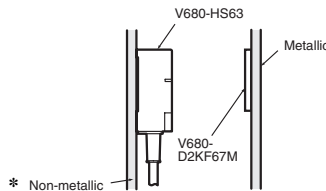

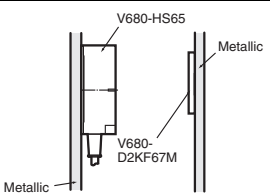

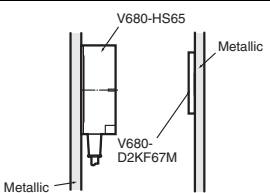

\*2. The Antenna can be mounted in metal, but the communications distance will decrease compared to mounting in nonmetal.

Confirm performance using the actual devices before actual operation.

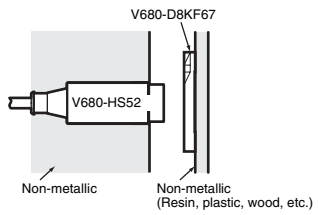

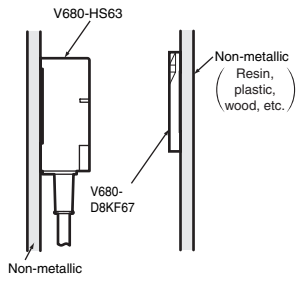

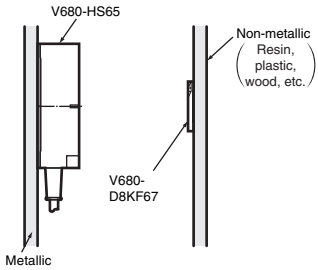

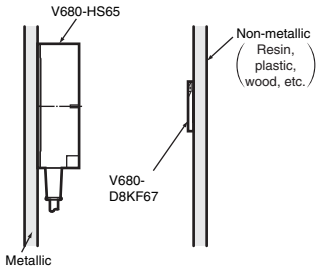



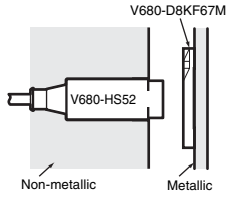

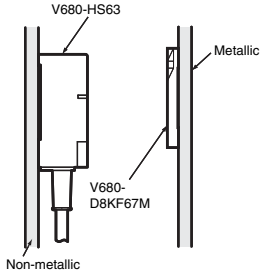
Recommended combination		Function	Transmission distance (unit: mm)	RF Tag and Antenna mounting conditions	
RF Tag	Antenna				
<b>V680-D2KF67M</b> (flush-mounted on metallic surface: steel)	<b>V680-HS52</b> 	Read distance	1.0 to 16.0 (axial deviation $\pm 2$ )		
		Write distance	1.0 to 16.0 (axial deviation $\pm 2$ )		
		<b>V680-HS63</b> 	Read distance	6.0 to 25.0 (axial deviation $\pm 10$ )	
			Write distance	6.0 to 25.0 (axial deviation $\pm 10$ )	
		<b>V680-HS65</b> 	Read distance	5.0 to 25.0 (axial deviation $\pm 10$ )	
			Write distance	5.0 to 25.0 (axial deviation $\pm 10$ )	

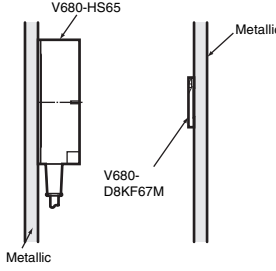
\* The Antenna can be mounted in metal, but the communications distance will decrease compared to mounting in nonmetal. Confirm performance using the actual devices before actual operation.

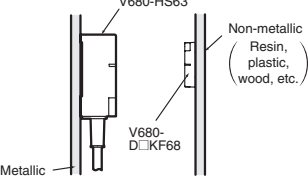
### RF Tag (8-/32-kbyte Memory) Transmission

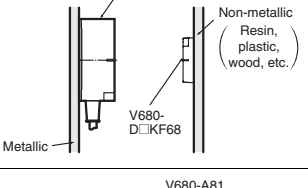
Recommended combination		Function	Transmission distance (unit: mm)	RF Tag and Antenna mounting conditions	
RF Tag	Antenna				
<b>V680-D8KF67</b>	<b>V680-HS52</b> 	Read distance	0 to 17.0 (axial deviation $\pm 2$ )		
		Write distance	0 to 17.0 (axial deviation $\pm 2$ )		
		<b>V680-HS63</b> 	Read distance	0 to 30.0 (axial deviation $\pm 10$ )	
			Write distance	0 to 30.0 (axial deviation $\pm 10$ )	
		<b>V680-HS65</b> 	Read distance	0 to 42.0 (axial deviation $\pm 10$ )	
			Write distance	0 to 42.0 (axial deviation $\pm 10$ )	

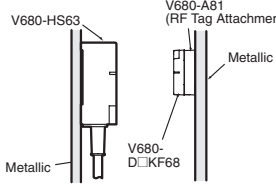
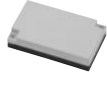

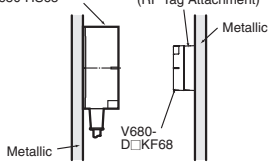





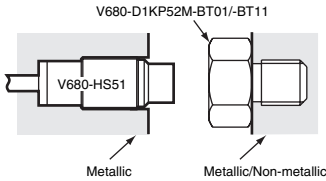

Recommended combination		Function	Transmission distance (unit: mm)	RF Tag and Antenna mounting conditions	
RF Tag	Antenna				
<b>V680-D8KF67M</b> (flush-mounted on metallic surface: steel)	<b>V680-HS52</b> 	Read distance	0 to 16.0 (axial deviation ±2)		
		Write distance	0 to 16.0 (axial deviation ±2)		
		<b>V680-HS63</b> 	Read distance	0 to 25.0 (axial deviation ±10)	
Write distance			0 to 25.0 (axial deviation ±10)		
	<b>V680-HS65</b> 	Read distance	0 to 25.0 (axial deviation ±10)		
		Write distance	0 to 25.0 (axial deviation ±10)		
<b>V680-D8KF68/-D32KF68</b> 	<b>V680-HS63</b> 	Read distance	5.0 to 45.0 * (axial deviation ±10)		
		Write distance	5.0 to 45.0 * (axial deviation ±10)		
		<b>V680-HS65</b> 	Read distance	5.0 to 75.0 * (axial deviation ±10)	
			Write distance	5.0 to 75.0 * (axial deviation ±10)	
<b>V680-D8KF68/-D32KF68</b> (Special attachment provided; flush-mounted on metallic surface: steel)	<b>V680-HS63</b> 	Read distance	5.0 to 35.0 (axial deviation ±10)		
		Write distance	5.0 to 35.0 (axial deviation ±10)		
		<b>V680-HS65</b> 	Read distance	5.0 to 55.0 (axial deviation ±10)	
			Write distance	5.0 to 55.0 (axial deviation ±10)	

**Note:** When mounting the V680-HS65, be sure to attach the Mounting Brackets at the base of the Antenna. The enclosed Mounting Brackets do not need to be used, however, if the mounting brackets on the Antenna are metal plates and their dimensions are larger than the dimensions of the Antenna (100 × 100 mm). For details, refer to the User's Manual (Cat. No. Z278 or Z279).

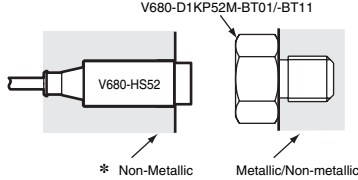
\* The transmission distance may be reduced if the V680-D□KF68 is mounted onto a metallic surface. Use V680-A81 special attachment. Refer to the User's Manual (Cat. No. Z278 or Z279) for details.

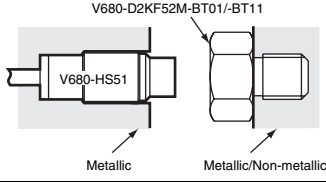
## Bolt RF Tag (1-kbyte or 2-kbyte Memory) Transmission

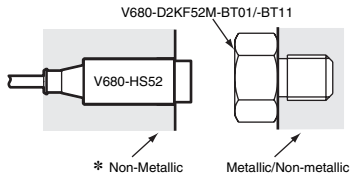
Recommended combination		Function	Transmission distance (unit: mm)	RF Tag and Antenna mounting conditions
RF Tag	Antenna			
<b>V680-D1KP52M-BT01/-BT11</b>  	<b>V680-HS51</b>  	Read distance	0.5 to 2.5 (axial deviation ±2)	 <p>V680-D1KP52M-BT01/-BT11</p> <p>Metallic      Metallic/Non-metallic</p>
		Write distance	0.5 to 2.0 (axial deviation ±2)	
<b>V680-D2KF52M-BT01/-BT11</b>  	<b>V680-HS52</b>  	Read distance	0.5 to 3.0 (axial deviation ±2)	 <p>V680-D1KP52M-BT01/-BT11</p> <p>* Non-Metallic      Metallic/Non-metallic</p>
		Write distance	0.5 to 2.5 (axial deviation ±2)	
<b>V680-D1KP52M-BT01/-BT11</b>  	<b>V680-HS51</b>  	Read distance	0.5 to 2.5 (axial deviation ±2)	 <p>V680-D2KF52M-BT01/-BT11</p> <p>Metallic      Metallic/Non-metallic</p>
		Write distance	0.5 to 2.5 (axial deviation ±2)	
	<b>V680-HS52</b>  	Read distance	0.5 to 2.0 (axial deviation ±2)	 <p>V680-D2KF52M-BT01/-BT11</p> <p>* Non-Metallic      Metallic/Non-metallic</p>
		Write distance	0.5 to 2.0 (axial deviation ±2)	

\* Mounting can be performed in metal, but the communications distance will decrease compared to mounting in nonmetal. Confirm performance using the actual devices before actual operation.

## Characteristic Data (Typical)

### Transmission Range (Typical)

#### ID Controller (using the V680-CA5D0□-V2, CJ1W-V680C11/C12, or CS1W-V680-C11/C12)

(unit: mm)

#### 1-kbyte Memory RF Tag

The values given for communications ranges are reference values. Refer to pages 17 to 19, 23 for communications distance specifications. The communications distance will depend on the RF Tags, ambient temperature, surrounding metal, noise, and other factors. Test operation completely when installing a system.

#### V680-HS52 (embedded in non-metallic material) & V680-D1KP52MT (embedded in non-metallic material)

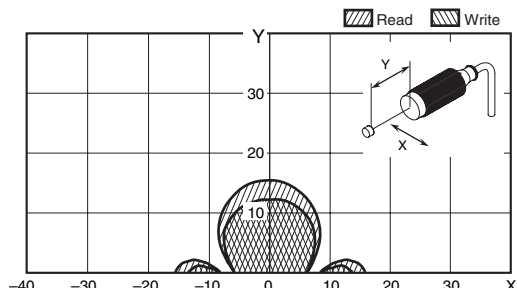

#### V680-HS51 (embedded in metallic material) & V680-D1KP52MT (embedded in non-metallic material)

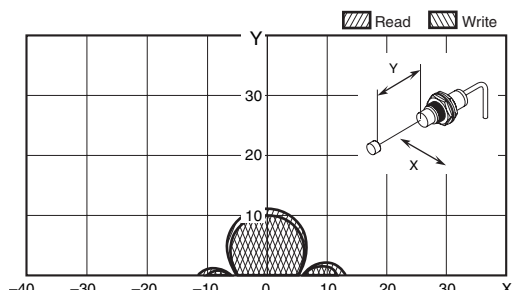

#### V680-HS63 (mounted on non-metallic material) & V680-D1KP52MT (embedded in non-metallic material)

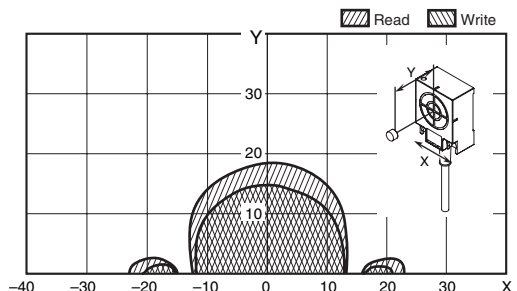

#### V680-HS51 (embedded in metallic material) & V680-D1KP53M (embedded in non-metallic material)

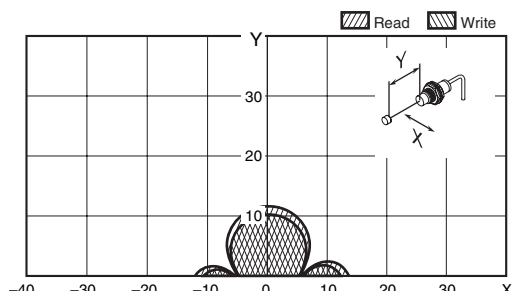

#### V680-HS52 (embedded in non-metallic material) & V680-D1KP53M (embedded in non-metallic material)

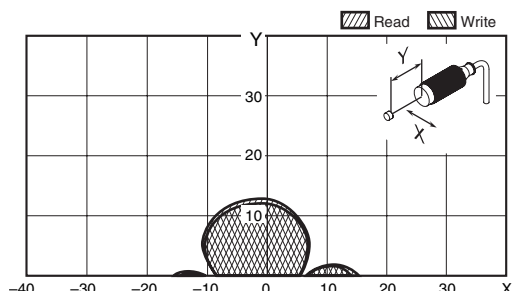

#### V680-HS52 (embedded in non-metallic material) & V680-D1KP52MT (embedded in metallic surface: steel)

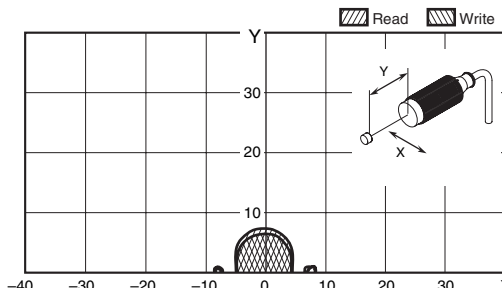

#### V680-HS51 (embedded in metallic material) & V680-D1KP52MT (embedded in metallic surface: steel)

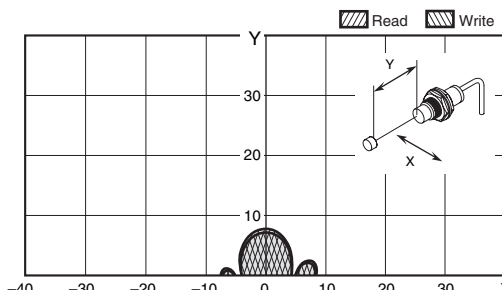

#### V680-HS51 (embedded in metallic material) & V680-D1KP53M (embedded in metallic surface: steel)

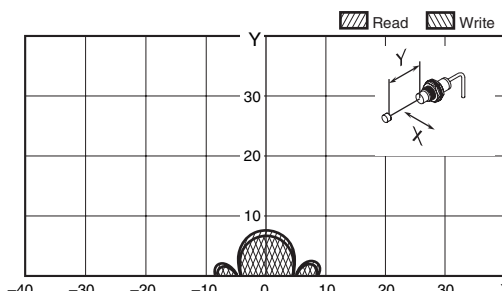

#### V680-HS52 (embedded in non-metallic material) & V680-D1KP53M (embedded in metallic surface: steel)

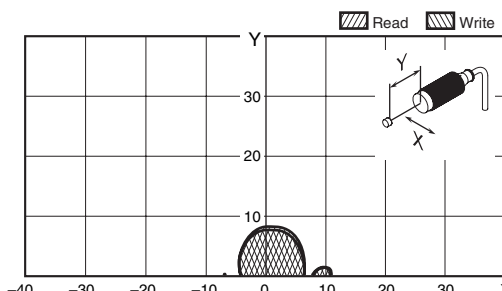

**V680-HS52 (embedded in non-metallic material) & V680-D1KP54T (mounted on non-metallic material)**

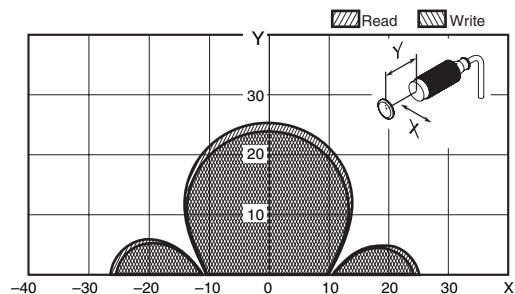

**V680-HS63 (mounted on non-metallic material) & V680-D1KP54T (mounted on non-metallic material)**

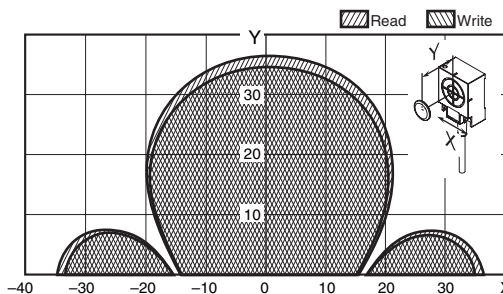

**V680-HS65 (mounted on metallic material) & V680-D1KP54T (mounted on non-metallic material)**

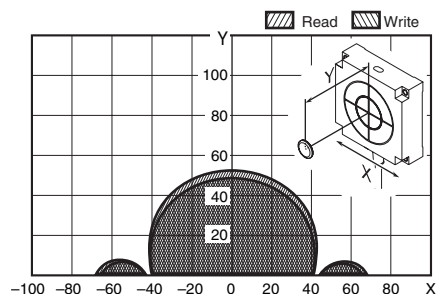

**V680-HS63 (mounted on non-metallic material) & V680-D1KP66T (mounted on non-metallic material)**

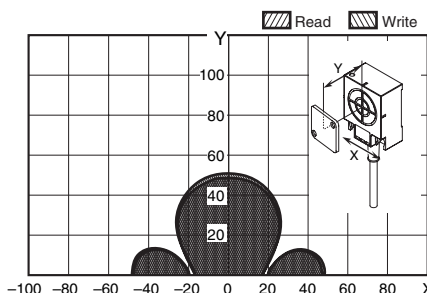

**V680-HS52 (embedded in non-metallic material) & V680-D1KP66T (mounted on non-metallic material)**

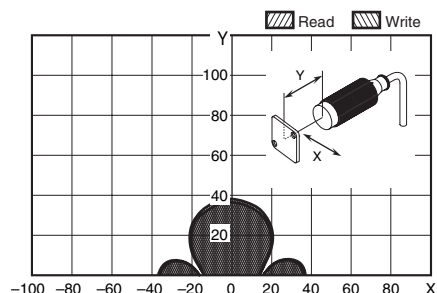

**V680-HS65 (mounted on metallic material) & V680-D1KP66T (mounted on non-metallic material)**

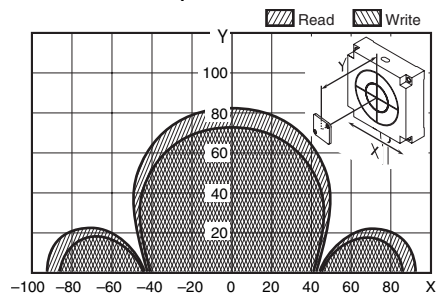

**V680-H01-V2 (mounted on non-metallic material) & V680-D1KP66T (mounted on non-metallic material)**

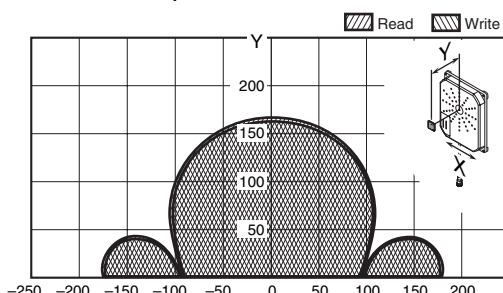

**V680-HS52 (embedded in non-metallic material) & V680-D1KP66T-SP (mounted on non-metallic material)**

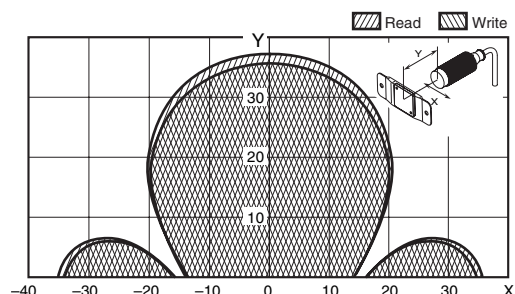

**V680-HS63 (mounted on non-metallic material) & V680-D1KP66T-SP (mounted on non-metallic material)**

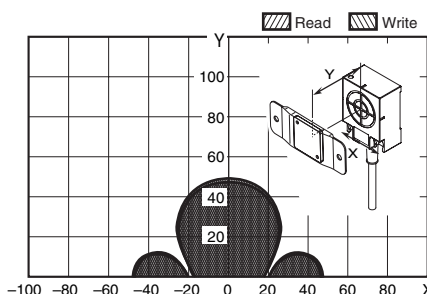

**V680-HS65 (mounted on metallic material) & V680-D1KP66T-SP (mounted on non-metallic material)**

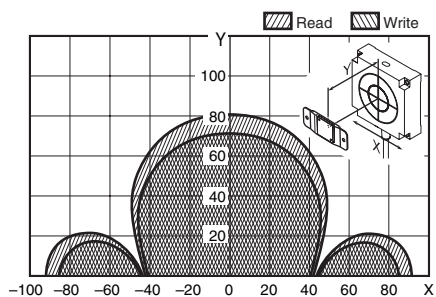

**V680-HS52 (embedded in non-metallic material) & V680-D1KP66MT (mounted on metallic surface: steel)**

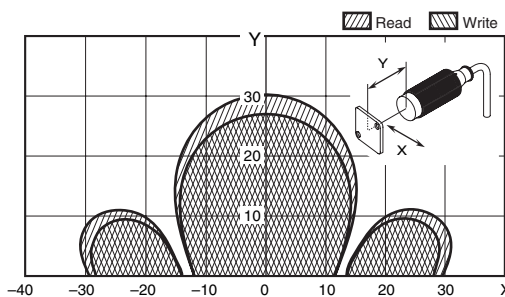

**V680-HS63 (mounted on non-metallic material) & V680-D1KP66MT (mounted on metallic surface: steel)**

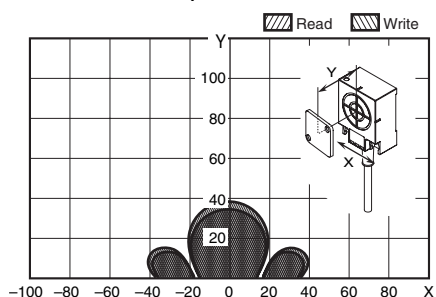

**V680-HS65 (mounted on metallic material) & V680-D1K66MT (mounted on metallic surface: steel)**

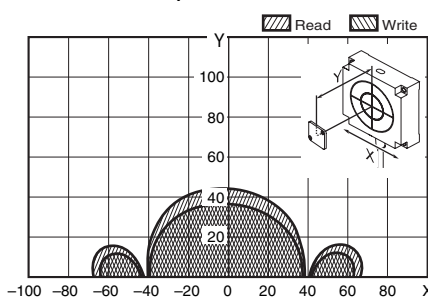

**1-kbyte Memory Bolt RF Tags**

**V680-HS51 (embedded in metallic material) & V680-D1KP52M-BT01 (mounted in metal/non-metallic material)**

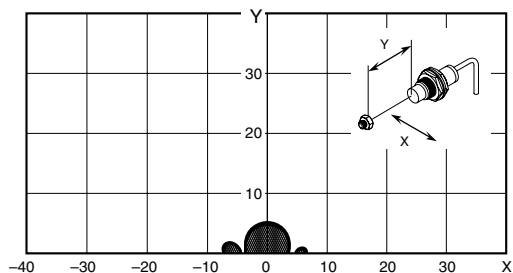

**V680-HS51 (embedded in metallic material) & V680-D1KP52M-BT11 (mounted in metal/non-metallic material)**

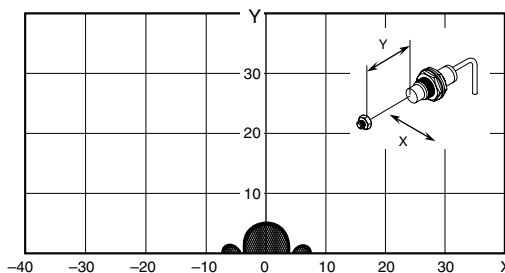

**V680-HS52 (embedded in non-metallic material) & V680-D1KP52M-BT01 (mounted in metal/non-metallic material)**

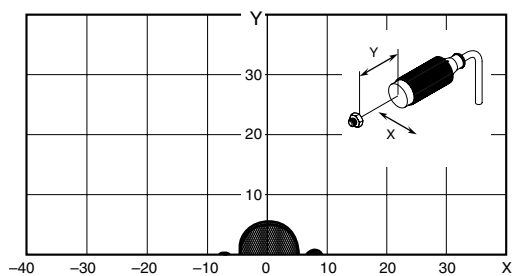

**High-temperature Type 1-kbyte Memory RF Tags**

**V680-H01 (mounted on non-metallic material) & V680-D1KP58HT (mounted on non-metallic material)**

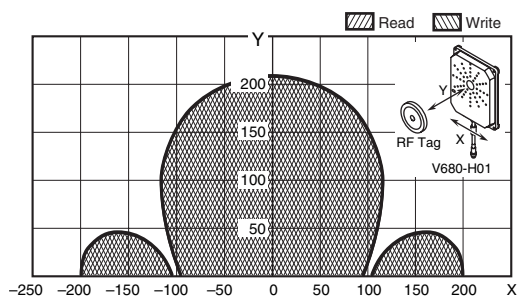

**2-kbyte Memory RF Tag**

The values given for communications ranges are reference values. Refer to pages 20 to 21, 23 for communications distance specifications. The communications distance will depend on the RF Tags, ambient temperature, surrounding metal, noise, and other factors. Test operation completely when installing a system.

**V680-HS52 (embedded in non-metallic material) & V680-D2KF52M (embedded in non-metallic material)**

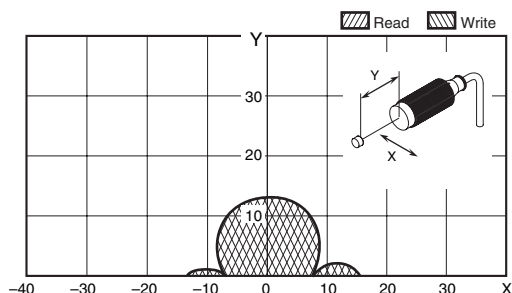

**V680-HS52 (embedded in non-metallic material) & V680-D2KF52M (embedded in metallic surface: steel)**

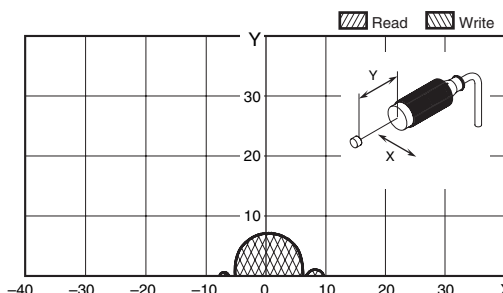

**V680-HS51 (embedded in metallic material) & V680-D2KF52M (embedded in non-metallic material)**

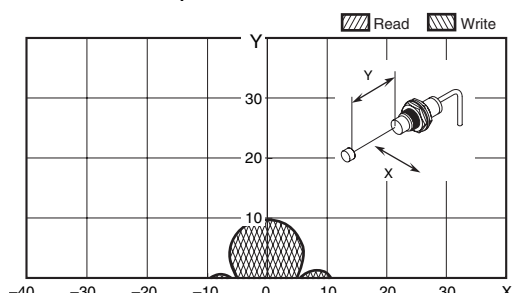

**V680-HS51 (embedded in metallic material) & V680-D2KF52M (embedded in metallic surface: steel)**

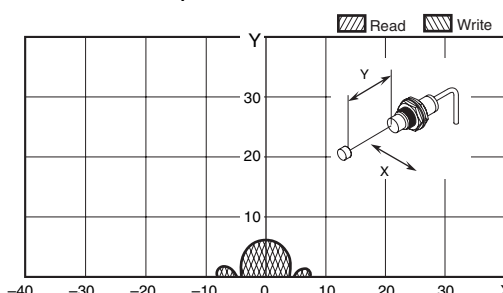

**V680-HS63 (mounted on non-metallic material) & V680-D2KF52M (embedded in non-metallic material)**

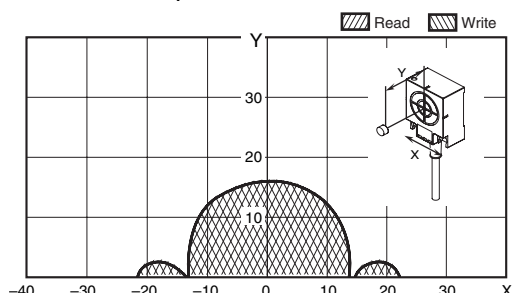

**V680-HS52 (embedded in metallic material) & V680-D2KF67 (mounted on non-metallic material)**

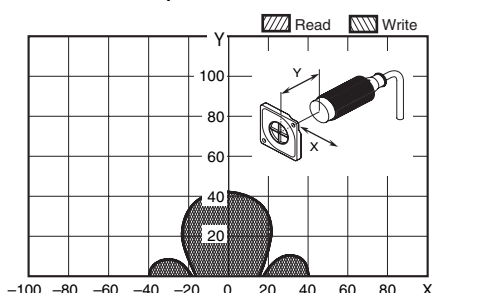

**V680-HS63 (mounted on non-metallic material) & V680-D2KF67 (mounted on non-metallic material)**

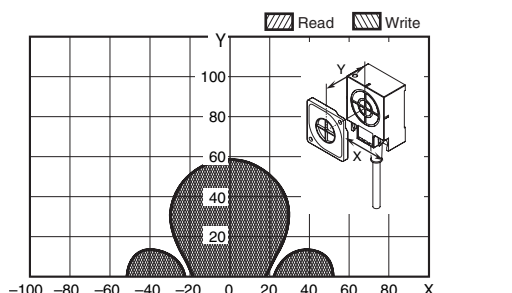

**V680-HS65 (mounted on metallic material) & V680-D2KF67 (mounted on non-metallic material)**

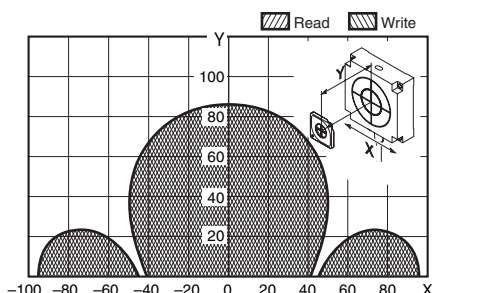

**V680-H01-V2 (mounted on non-metallic material) & V680-D2KF67 (mounted on non-metallic material)**

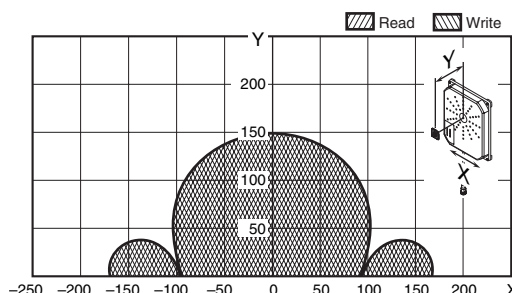

**V680-HS52 (embedded in non-metallic material) & V680-D2KF67M (mounted on metallic surface: steel)**

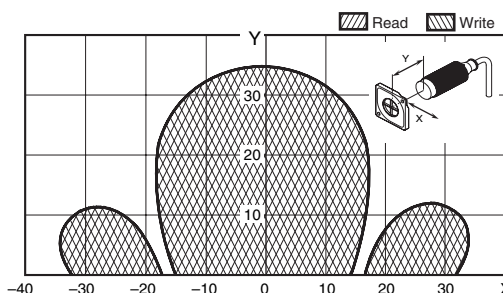



**V680-HS63 (mounted on non-metallic material) & V680-D2KF67M (mounted on metallic surface: steel)**

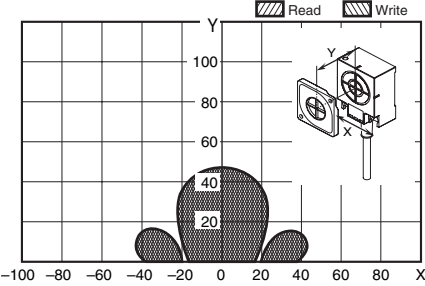

**V680-HS65 (mounted on metallic material) & V680-D2KF67M (mounted on metallic surface: steel)**

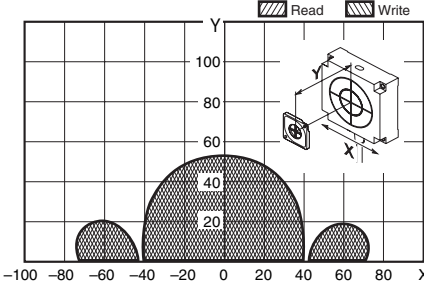

**2-kbyte Memory Bolt RF Tags**

**V680-HS51 (embedded in metallic material) & V680-D2KF52M-BT01 (mounted in metal/non-metallic material)**

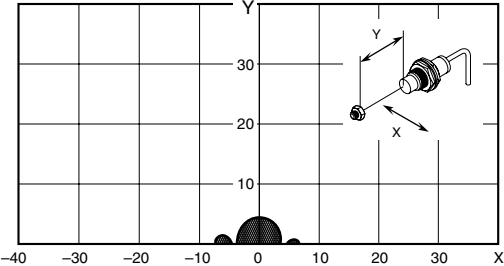

**V680-HS51 (embedded in metallic material) & V680-D2KF52M-BT11 (mounted in metal/non-metallic material)**

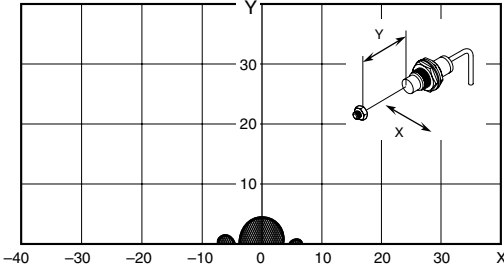

**V680-HS52 (embedded in non-metallic material) & V680-D2KF52M-BT01 (mounted in metal/non-metallic material)**

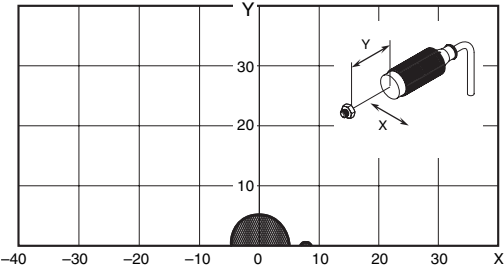

**8-/32-kbyte Memory RF Tag**

The values given for communications ranges are reference values. Refer to pages 21 to 22 for communications distance specifications. The communications distance will depend on the RF Tags, ambient temperature, surrounding metal, noise, and other factors. Test operation completely when installing a system.

**V680-HS52 (embedded in non-metallic material) & V680-D8KF67 (mounted on non-metallic material)**

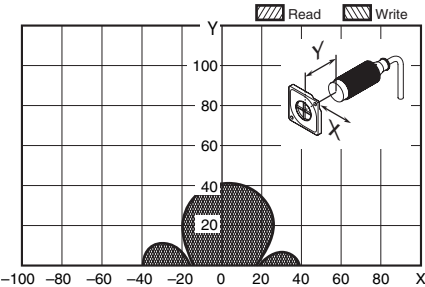

**V680-HS63 (mounted on non-metallic material) & V680-D8KF67 (mounted on non-metallic material)**

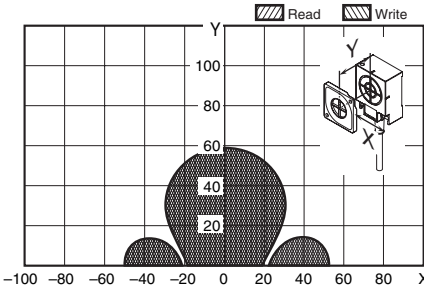

**V680-HS65 (mounted on metallic material) & V680-D8KF67 (mounted on non-metallic material)**

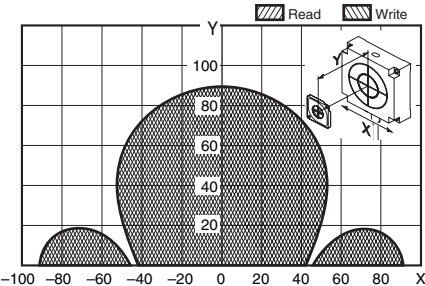

**V680-H01-V2 (mounted on non-metallic material) & V680-D8KF67 (mounted on non-metallic material)**

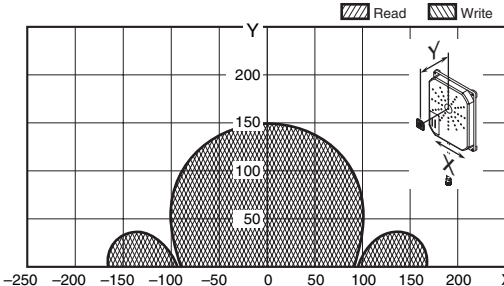

V680-HS52 (embedded in non-metallic material) & V680-D8KF67M (mounted on metallic surface: steel)

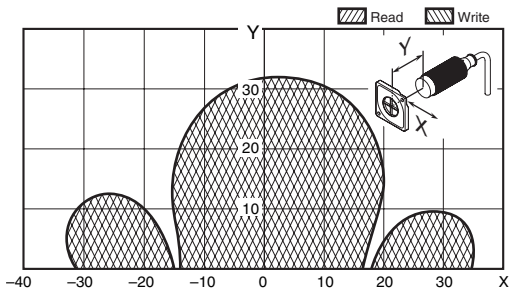

V680-HS63 (mounted on non-metallic material) & V680-D8KF67M (mounted on metallic surface: steel)

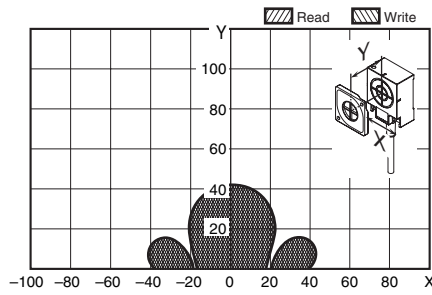

V680-HS65 (mounted on metallic material) & V680-D8KF67M (mounted on metallic surface: steel)

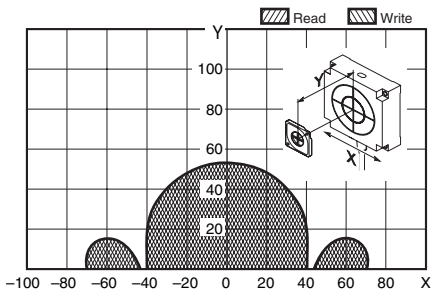

V680-HS63 (mounted on metallic material) & V680-D8KF68/-D32KF68 (mounted on non-metallic material) (Horizontal-facing RF Tag) | V680-HS63 (mounted on metallic material) & V680-D8KF68/-D32KF68 (mounted on non-metallic material) (Vertical-facing RF Tag)

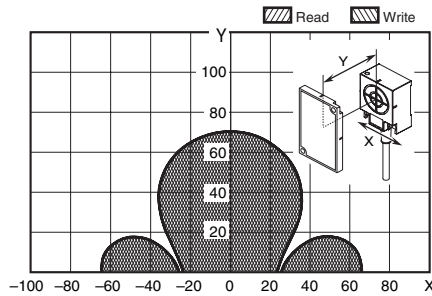
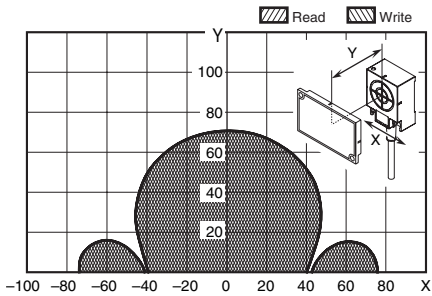

V680-HS63 (mounted on metallic material) & V680-D8KF68/-D32KF68 (mounted on metallic surface: steel) (Horizontal-facing RF Tag) | V680-HS63 (mounted on metallic material) & V680-D8KF68/-D32KF68 (mounted on metallic surface: steel) (Vertical-facing RF Tag)

When the V680-A81 attachment is mounted on RF Tag

When the V680-A81 attachment is mounted on RF Tag

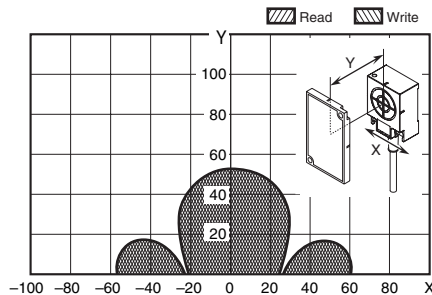
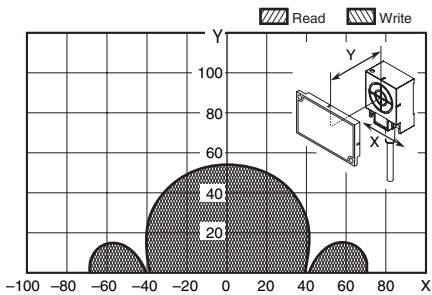

V680-HS65 (mounted on metallic material) & V680-D8KF68/-D32KF68 (Horizontal-facing RF Tag)

V680-HS65 (mounted on metallic material) & V680-D8KF68/-D32KF68 (Vertical-facing RF Tag)

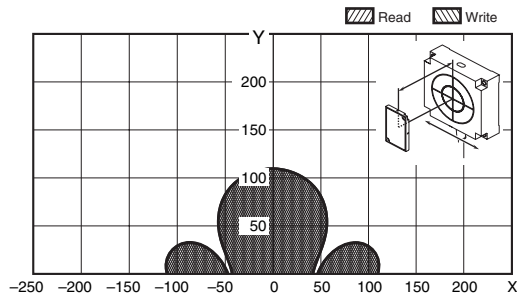
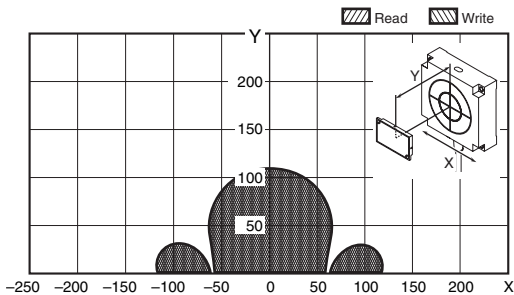



**V680-HS65 (mounted on metallic material) & V680-D8KF68/-D32KF68 (flush-mounted on metallic surface: steel) (Horizontal-facing RF Tag)**  
**When the V680-A81 attachment is mounted on RF Tag**

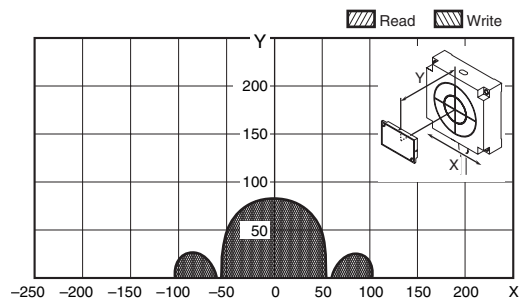

**V680-HS65 (mounted on metallic material) & V680-D8KF68/-D32KF68 (flush-mounted on metallic surface: steel) (Vertical-facing RF Tag)**  
**When the V680-A81 attachment is mounted on RF Tag**

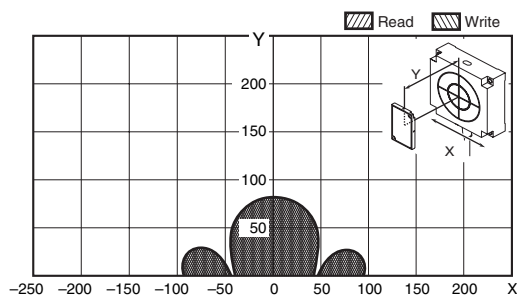

**V680-H01-V2 (mounted on non-metallic material) & V680-D8KF68/-D32KF68 (Horizontal-facing RF Tag)**

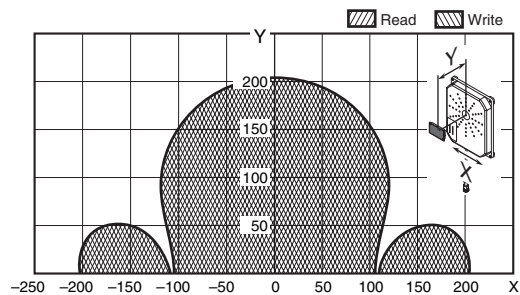

**V680-H01-V2 (mounted on non-metallic material) & V680-D8KF68/-32KF68 (Vertical-facing RF Tag)**

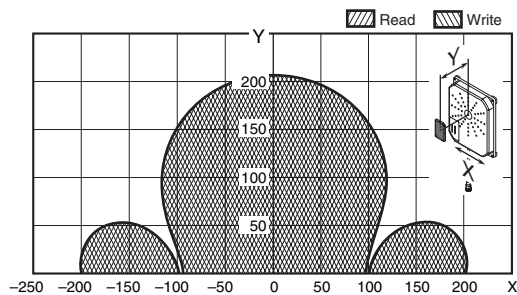

**DeviceNet ID Slave (When Using the V680-HAM42-DRT)  
PROFIBUS ID Slave (When Using the V680-HAM42-PRT)  
ID Flag Sensors (When Using the V680-HAM91/-HAM81)**

**1-kbyte Memory RF Tag**

The values given for communications ranges are reference values. Refer to pages 24 to 26, 30 for communications distance specifications. For information on the combinations that can be used, refer to Combinations of Amplifier Units, Antennas, and RF Tags on pages 2 to 3. The communications distance will depend on the RF Tags, ambient temperature, surrounding metal, noise, and other factors. Test operation completely when installing a system.

**V680-HS52 (embedded in non-metallic material) & V680-D1KP52MT (embedded in non-metallic material)**

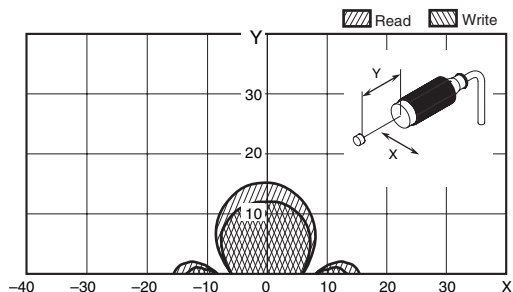

**V680-HS51 (embedded in metallic material) & V680-D1KP52MT (embedded in non-metallic material)**

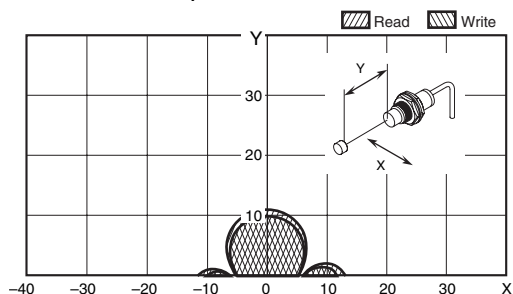

**V680-HS63 (mounted on non-metallic material) & V680-D1KP52MT (embedded in non-metallic material)**

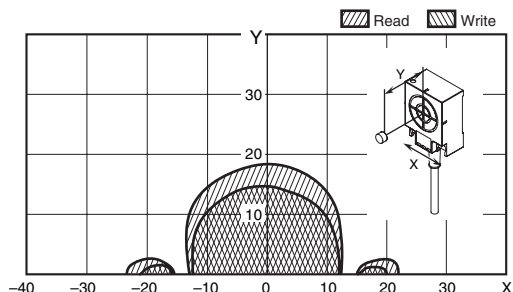

**V680-HS63 (mounted on non-metallic material) & V680-D1KP66T (mounted on non-metallic material)**

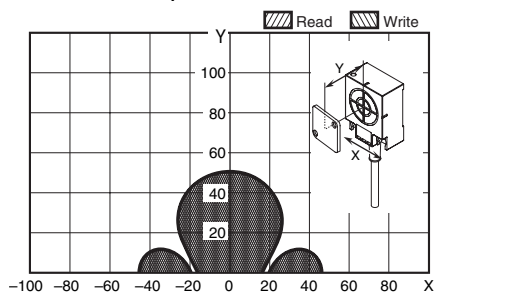

**V680-HS52 (embedded in non-metallic material) & V680-D1KP66T-SP (embedded in non-metallic material)**

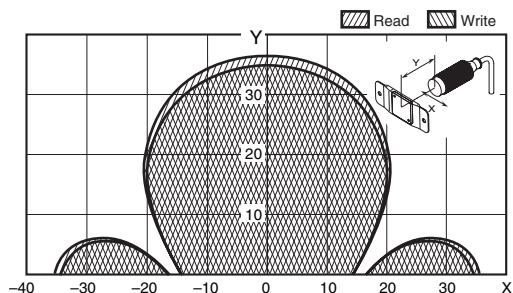

**V680-HS52 (embedded in non-metallic material) & V680-D1KP52MT (embedded in metallic surface: steel)**

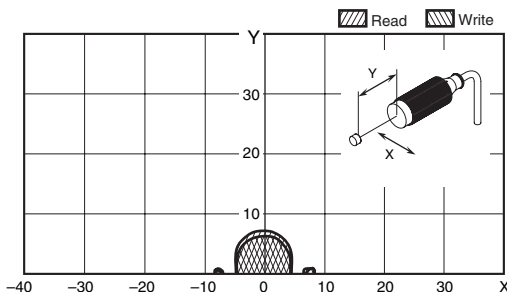

**V680-HS51 (embedded in metallic material) & V680-D1KP52MT (embedded in metallic surface: steel)**

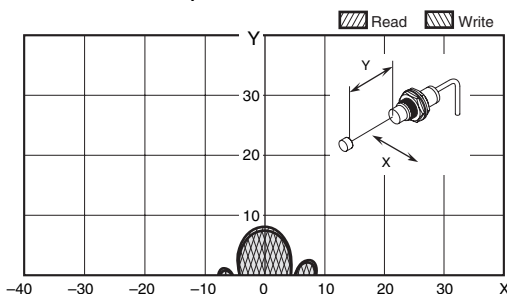

**V680-HS52 (embedded in non-metallic material) & V680-D1KP66T (mounted on non-metallic material)**

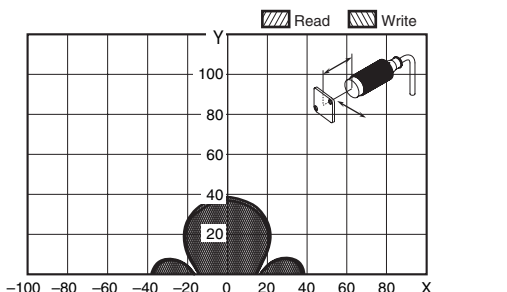

**V680-HS65 (mounted on metallic material) & V680-D1KP66T (mounted on non-metallic material)**

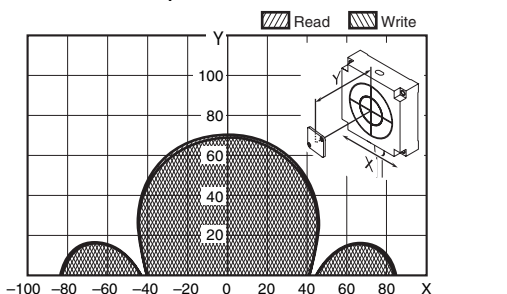

**V680-HS63 (mounted on non-metallic material) & V680-D1KP66T-SP (mounted on non-metallic material)**

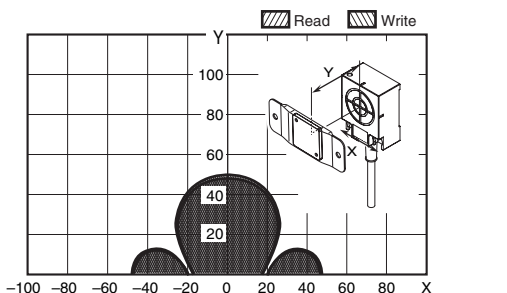

**V680-HS65 (mounted on metallic material) & V680-D1KP66T-SP (mounted on non-metallic material)**

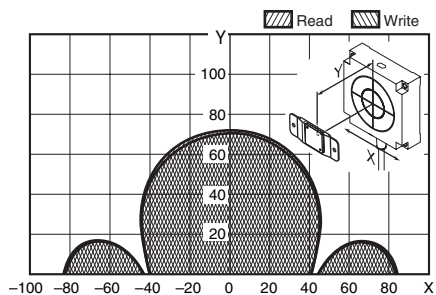

**V680-HS63 (mounted on non-metallic material) & V680-D1KP66MT (mounted on metallic surface: steel)**

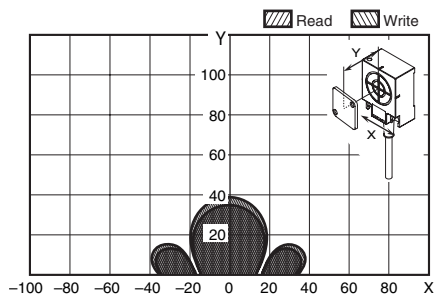

**1-kbyte Memory Bolt RF Tags**

**V680-HS51 (embedded in metallic material) & V680-D1KP52M-BT01 (mounted in metal/non-metallic material)**

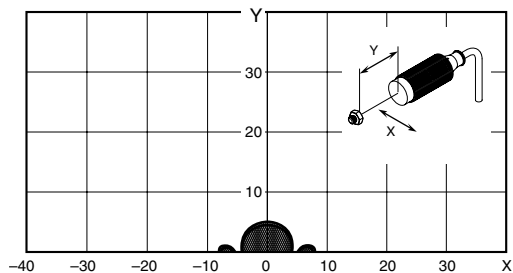

**V680-HS52 (embedded in non-metallic material) & V680-D1KP66MT (mounted on metallic surface: steel)**

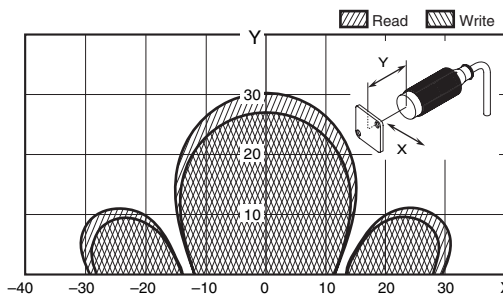

**V680-HS65 (mounted on metallic material) & V680-D1K66MT (mounted on metallic surface: steel)**

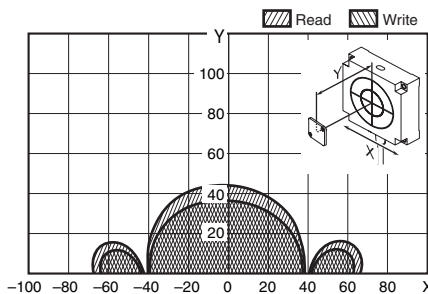

**V680-HS52 (embedded in non-metallic material) & V680-D1KP52M-BT01 (mounted in metal/non-metallic material)**

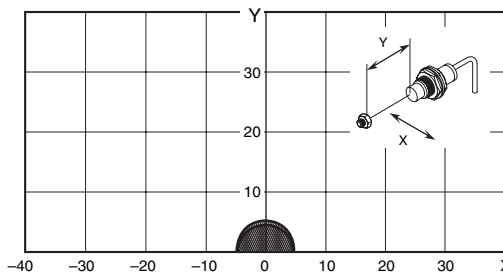

**2-kbyte Memory RF Tag**

The values given for communications ranges are reference values. Refer to pages 27 to 28, 30 for communications distance specifications. For information on the combinations that can be used, refer to Combinations of Amplifier Units, Antennas, and RF Tags on pages 2 to 3. The communications distance will depend on the RF Tags, ambient temperature, surrounding metal, noise, and other factors. Test operation completely when installing a system.

**V680-HS52 (embedded in non-metallic material) & V680-D2KF52M (embedded in non-metallic material)**

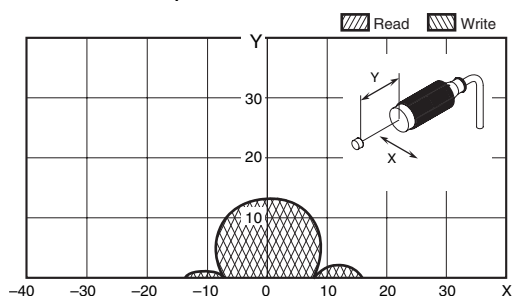

**V680-HS51 (embedded in metallic material) & V680-D2KF52M (embedded in non-metallic material)**

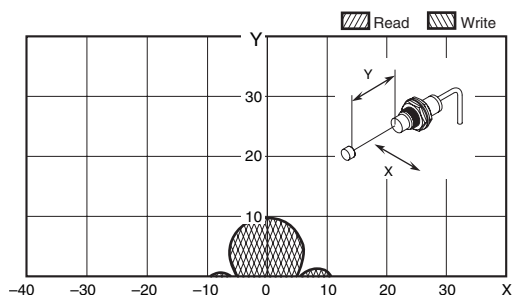

**V680-HS52 (embedded in non-metallic material) & V680-D2KF52M (embedded in metallic surface: steel)**

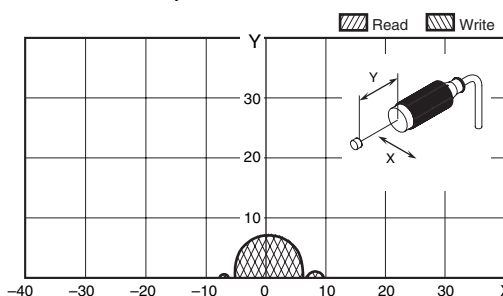

**V680-HS51 (embedded in metallic material) & V680-D2KF52M (embedded in metallic surface: steel)**

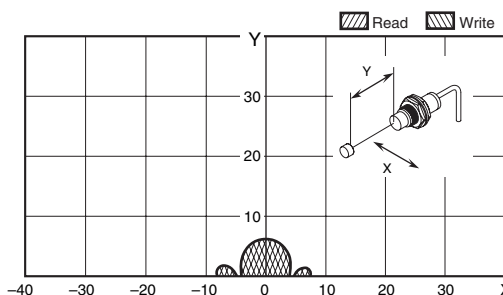

**V680-HS63 (mounted on non-metallic material) & V680-D2KF52M (embedded in non-metallic material)**

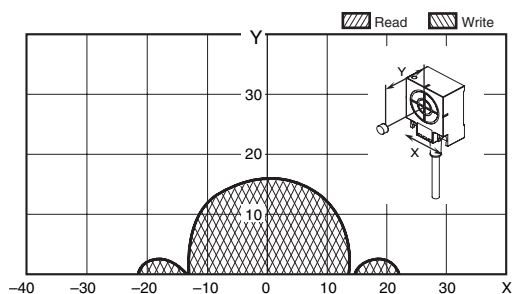

**V680-HS63 (mounted on non-metallic material) & V680-D2KF67 (mounted on non-metallic material)**

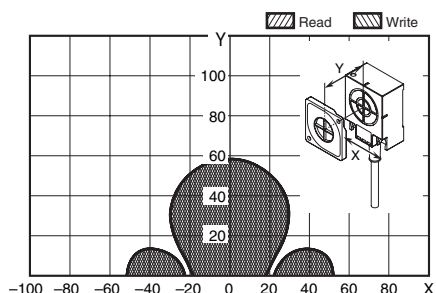

**V680-HS52 (embedded in non-metallic material) & V680-D2KF67M (mounted on metallic surface: steel)**

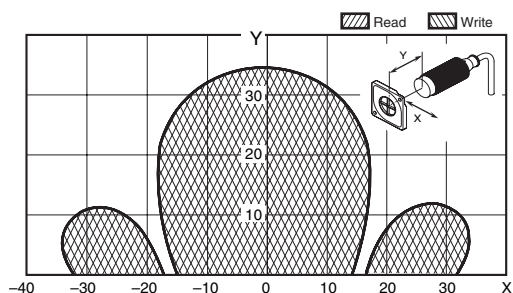

**V680-HS65 (mounted on metallic material) & V680-D2KF67M (mounted on metallic surface: steel)**

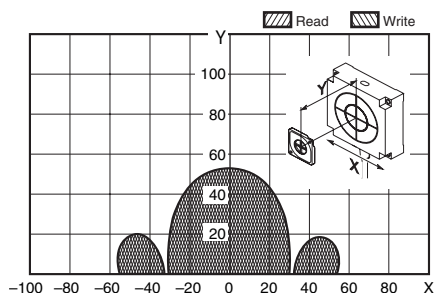

**2-kbyte Memory Bolt RF Tags**

**V680-HS51 (embedded in metallic material) & V680-D2KF52M-BT01 (mounted in metal/non-metallic material)**

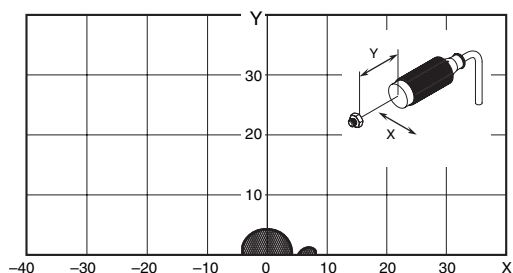

**V680-HS52 (embedded in non-metallic material) & V680-D2KF67 (mounted on non-metallic material)**

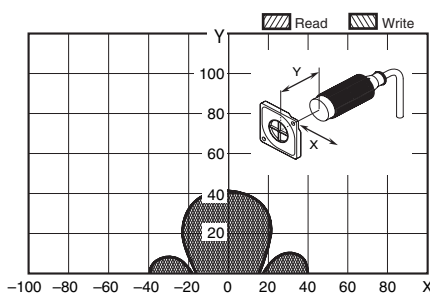

**V680-HS65 (mounted on metallic material) & V680-D2KF67 (mounted on non-metallic material)**

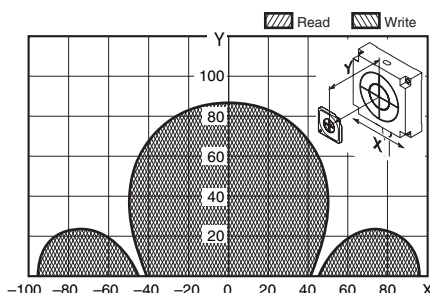

**V680-HS63 (mounted on non-metallic material) & V680-D2KF67M (mounted on metallic surface: steel)**

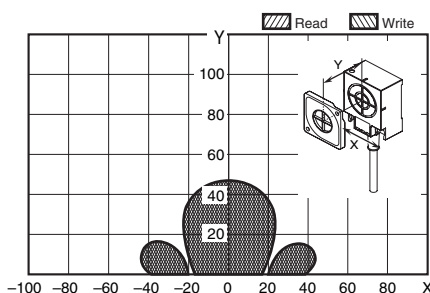

**V680-HS52 (embedded in non-metallic material) & V680-D2KF52M-BT01 (mounted in metal/non-metallic material)**

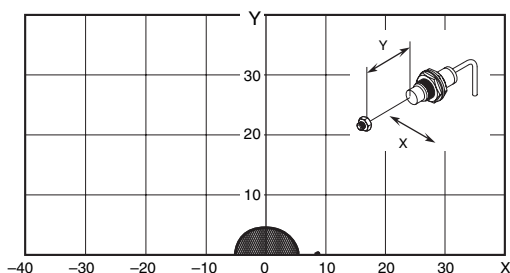

**8-/32-kbyte Memory RF Tag**

The values given for communications ranges are reference values. Refer to pages 28 to 29 for communications distance specifications. For information on the combinations that can be used, refer to Combinations of Amplifier Units, Antennas, and RF Tags on pages 2 to 3. The communications distance will depend on the RF Tags, ambient temperature, surrounding metal, noise, and other factors. Test operation completely when installing a system.

**V680-HS63 (mounted on metallic material) & V680-D8KF68/-D32KF68 (mounted on non-metallic material) (Horizontal-facing RF Tag)**

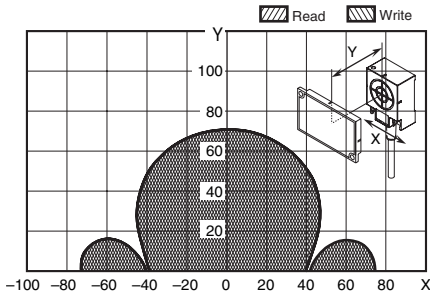

**V680-HS63 (mounted on metallic material) & V680-D8KF68/-D32KF68 (mounted on non-metallic material) (Vertical-facing RF Tag)**

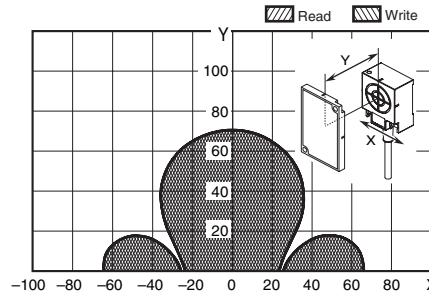

**V680-HS63 (mounted on metallic material) & V680-D8KF68/-D32KF68 (mounted on metallic surface: steel) (Horizontal-facing RF Tag)**  
When the V680-A81 attachment is mounted on RF Tag

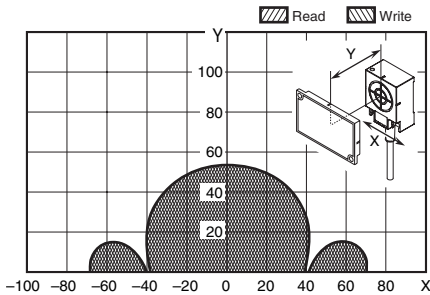

**V680-HS63 (mounted on metallic material) & V680-D8KF68/-D32KF68 (mounted on metallic surface: steel) (Vertical-facing RF Tag)**  
When the V680-A81 attachment is mounted on RF Tag

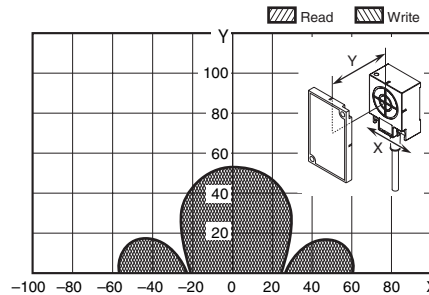

**V680-HS65 (mounted on metallic material) & V680-D8KF68/-D32KF68 (mounted on non-metallic material) (Horizontal-facing RF Tag)**

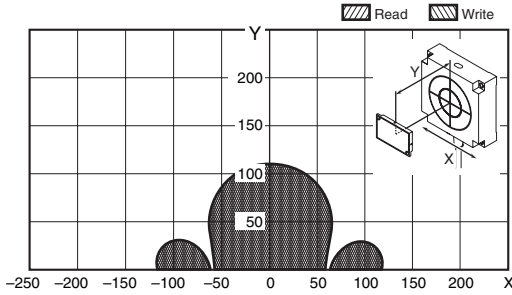

**V680-HS65 (mounted on metallic material) & V680-D8KF68/-D32KF68 (mounted on non-metallic material) (Vertical-facing RF Tag)**

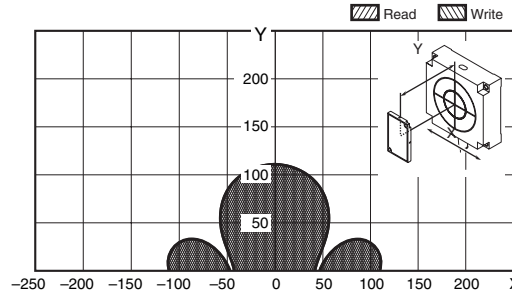

**V680-HS65 (mounted on metallic material) & V680-D8KF68/-D32KF68 (flush-mounted on metallic surface: steel) (Horizontal-facing RF Tag)**  
When the V680-A81 attachment is mounted on RF Tag

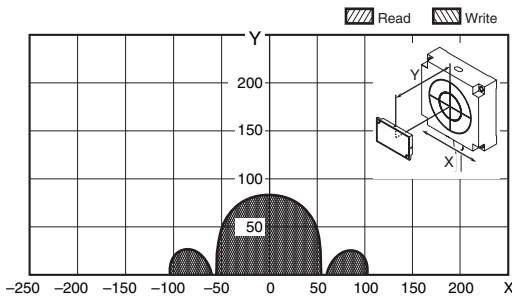

**V680-HS65 (mounted on metallic material) & V680-D8KF68/-D32KF68 (flush-mounted on metallic surface: steel) (Vertical-facing RF Tag)**  
When the V680-A81 attachment is mounted on RF Tag

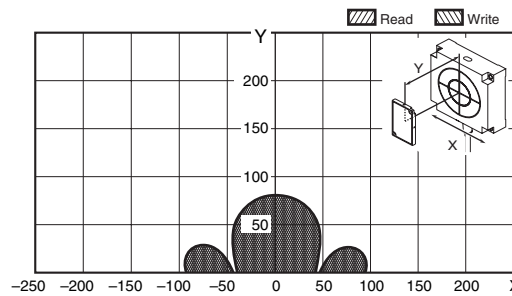



## Communications Time

### Communications Time between Antennas and Tags

#### ID Controllers (V680-CA5D0□-V2, CJ1W-V680C11/C12, CS1W-V680C11/12)

##### 1-kbyte Memory RF Tag

V680-D1KP□ (used in combination with the V680-HS□□ Antenna, V680-HA63A Amplifier Unit and V680-H01-V2 Antenna)

V680-D1KP58HT (used in combination with the V680-H01-V2 Antenna)

##### ●Transmission speed: Normal mode

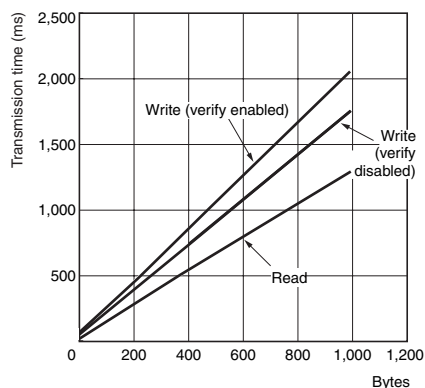

##### ●Transmission speed: High-speed mode

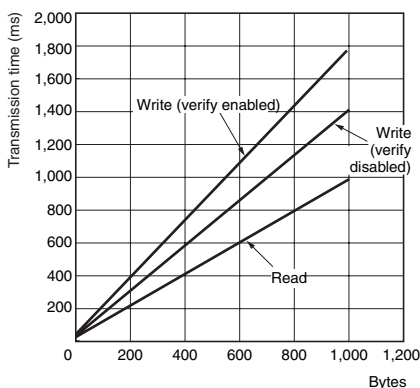

Controller or ID Sensor Unit transmission speed setting	Command	Write verification setting	Transmission time (ms) N = Number of processing bytes
Normal mode	Read	—	$T=1.3N+31$
	Write	Enabled	$T=2.1N+58$
Disabled		$T=1.8N+56$	
High-speed mode *1, *2	Read	—	$T=1.0N+29$
	Write	Enabled	$T=1.8N+51$
Disabled		$T=1.5N+47$	

\*1. The V680-H01 Antenna cannot be used in high-speed mode.

\*2. When multi-access or FIFO is selected as the transmission option, the transmission time will be the same as in normal mode even when the transmission speed is set to high-speed mode.

##### 2-kbyte Memory RF Tag

V680-D2KF□□ (used in combination with the V680-HS□□ Antenna, V680-HA63B Amplifier Unit and V680-H01-V2 Antenna)

##### ●Transmission speed: Normal mode

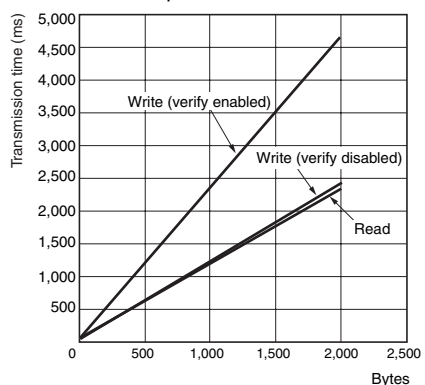

##### ●Transmission speed: High-speed mode

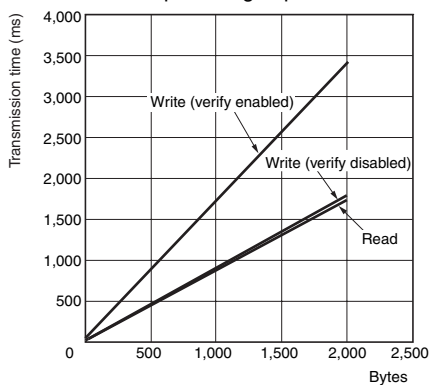

Controller or ID Sensor Unit transmission speed setting	Command	Write verification setting	Transmission time (ms) N = Number of processing bytes
Normal mode	Read	—	$T=1.2N+30$
	Write	Enabled	$T=2.4N+49$
Disabled		$T=1.2N+49$	
High-speed mode *	Read	—	$T=0.9N+27$
	Write	Enabled	$T=1.7N+49$
Disabled		$T=0.9N+41$	

\*When multi-access or FIFO is selected as the transmission option, the transmission time will be the same as in normal mode even when the transmission speed is set to high-speed mode.

##### 8-/32-kbyte Memory RF Tag

V680-D8KF□□, V680-D32KF□□

(used in combination with the V680-HS□□ Antenna, V680-HA63B Amplifier Unit and V680-H01-V2 Antenna)

##### ●Transmission speed: Normal mode

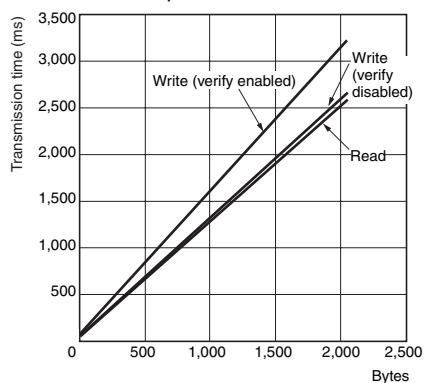

##### ●Transmission speed: High-speed mode

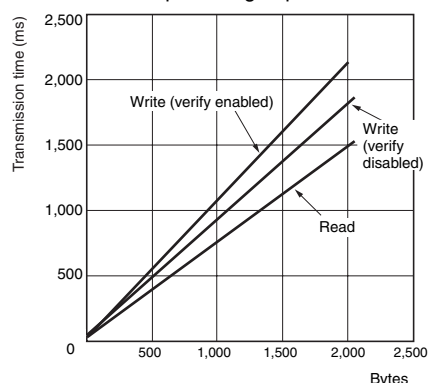

Controller or ID Sensor Unit transmission speed setting	Command	Write verification setting	Transmission time (ms) N = Number of processing bytes
Normal mode	Read	—	$T=1.3N+30$
	Write	Enabled	$T=1.6N+59$
Disabled		$T=1.3N+50$	
High-speed mode *	Read	—	$T=0.8N+25$
	Write	Enabled	$T=1.1N+41$
Disabled		$T=0.9N+40$	

\*When multi-access or FIFO is selected as the transmission option, the transmission time will be the same as in normal mode even when the transmission speed is set to high-speed mode.

**Communications Time (Communications Time between Antenna and RF Tag + Processing Time at Amplifier Unit)**

**DeviceNet ID Slave (V680-HAM42-DRT)  
PROFIBUS ID Slave (V680-HAM42-PRT)**

**1-kbyte Memory RF Tags**

V680-D1KP□ (V680-HS□□ Antenna)

Communications time setting	Command	Communications time (ms)			
		4-byte Access Mode	26-byte Access Mode	58-byte Access Mode	V600-compatible mode *
Normal	Read	67	95	137	67
	Write with Verification	105	143	210	105
	Data Fill	V680-HAM42-DRT: 17.5 × No. of processed blocks + 89.2 V680-HAM42-PRT: 20.6 × No. of processed blocks + 76.8			–
High speed	Read	63	85	117	–
	Write with Verification	89	128	186	–
	Data Fill	V680-HAM42-DRT: 14.8 × No. of processed blocks + 71.7 V680-HAM42-PRT: 18.8 × No. of processed blocks + 66.4			–

**2-kbyte Memory RF Tags**

V680-D2KF□ (V680-HS□□ Antenna)

Communications time setting	Command	Communications time (ms)			
		4-byte Access Mode	26-byte Access Mode	58-byte Access Mode	V600-compatible mode *
Normal	Read	65	92	130	65
	Write with Verification	105	142	219	105
	Data Fill	V680-HAM42-DRT: 17.5 × No. of processed blocks + 89.2 V680-HAM42-PRT: 21.2 × No. of processed blocks + 86.4			–
High speed	Read	61	81	110	–
	Write with Verification	86	124	178	–
	Data Fill	V680-HAM42-DRT: 14.8 × No. of processed blocks + 71.7 V680-HAM42-PRT: 17.2 × No. of processed blocks + 74.6			–

**8-kbyte/32-kbyte Memory RF Tags**

V680-D8KF□□ and V680-D32KF68 (V680-HS□□ Antenna)

Communications time setting	Command	Communications time (ms)			
		4-byte Access Mode	26-byte Access Mode	58-byte Access Mode	V600-compatible mode *
Normal	Read	66	94	136	66
	Write with Verification	96	131	182	96
	Data Fill	V680-HAM42-DRT: 17.5 × No. of processed blocks + 89.2 V680-HAM42-PRT: 13.8 × No. of processed blocks + 87.4			–
High speed	Read	59	76	102	–
	Write with Verification	76	100	135	–
	Data Fill	V680-HAM42-DRT: 14.8 × No. of processed blocks + 71.7 V680-HAM42-PRT: 9.0 × No. of processed blocks + 77.0			–

\* The V680-HAM42-PRT does not support V600-compatible mode.

**ID Flag Sensors (V680-HAM91/-HAM81)**

RF Tag	Operating Mode	Communications time (ms)	
		Read	Write
		Data Read, Verification read	Write, Bit Set, Bit Clear
1-kbyte/2-kbyte Memory RF Tag		43	87
8-kbyte/32-kbyte Memory RF Tags		50	84

$$\text{RF Tag travel speed (conveyor speed)} = \frac{\text{Travel distance (D) in communications area}}{\text{Communications time (T)}}$$

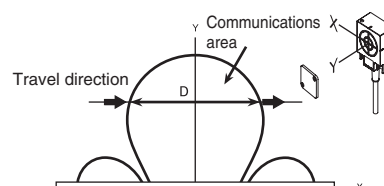

**Calculation Example**

**Read Processing Using Combination of V680-D1KP66T and V680-HS63**

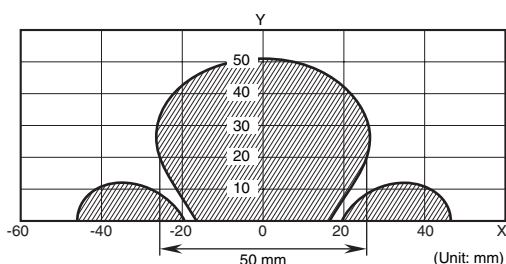

$$\text{RF Tag travel speed (m/min)} = \frac{50(\text{mm})}{43(\text{ms})} \div 60 \div 1000 \approx 69(\text{m/min})$$

- Note:**
1. The travel speed depends on factors such as the communications distance Y and axial deviation. Therefore, it is recommended to refer to the communications area figure and to perform operation using the widest part of the area.
  2. The calculated value is a rough guide.  
Perform testing with the actual devices before actual operation.
  3. This calculation formula does not include communications error processing.



### TAT When Using an ID Controller (Reference Values)

#### TAT (Turn Around Time)

TAT refers to the total time required from the point at which a host device (such as a personal computer) starts sending a command until a response is received.

$$\text{TAT} = \text{Command send time} + \text{RF Tag transmission time} + \text{response}$$

Command send time: This is the time required for sending a command from the host device to the Controller.

It varies depending on the communications speed and format.

RF Tag transmission time: This is the time required for transmission between the Antenna and the RF Tag.

Response receipt time: This is the time required for returning a response from the Controller to the host device.

It varies depending on the communications speed and format.

- For an ordinary command

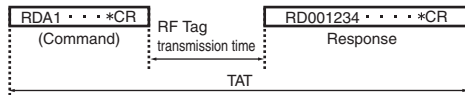

- Expansion Read Command

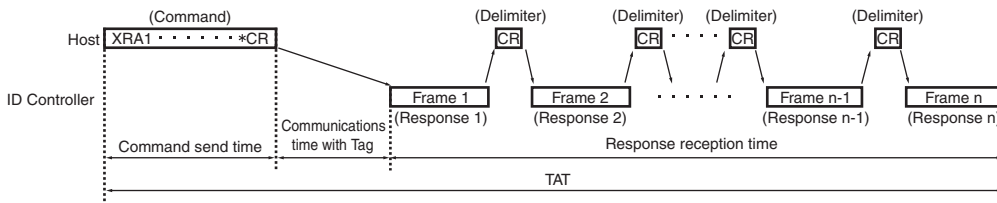

- Expansion Write Command

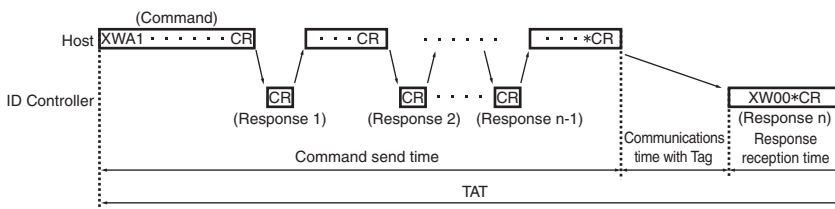

## Safety Precautions

### WARNING

Do not use this product as a detection device to protect people.



\* This catalog is intended only to help select the appropriate product. Be sure to read the User's Manual for usage precautions prior to using the product.

### Precautions for Safe Use

To ensure safety, be sure to follow the following precautions:

1. Do not operate this product in any flammable, explosive, or corrosive gas environment.
2. Do not disassemble, repair, or remodel this product.
3. Tighten the base lock screws and terminal block screws completely.
4. Be sure to use wiring crimp terminals of the specified size.
5. If any cable has a locking mechanism, be sure to check that it has been locked before using it.
6. The DC power supply must be within the specified rating (24 VDC +10%/–15%).
7. Do not reverse the power supply connection.
8. Do not insert water, wire, etc., into any of the gaps in the case. Doing so may cause fire or electric shock.
9. Turn OFF the Controller or ID Sensor Unit power before attaching or removing the Antenna.
10. If multiple Antennas are mounted near each other, communications performance may decrease due to mutual interference. Refer to the manual for the Antennas and RF Tags and check to make sure there is no mutual interference before installation.
11. To remove the ID Controller, catch a tool on the mounting hook and gently remove the Unit.
12. Wire correctly and do not short-circuit the load. The ID Controller may rupture or burn.
13. Do not use in environments that are subject to oil.
14. Never use an AC power supply.
15. In the event that the product exhibits any abnormal condition, immediately stop using the system, turn OFF the power, and contact your OMRON sales representative.
16. Dispose of this product as industrial waste.
17. Be sure to follow any other warnings, cautions, and notices given in this document.

### Precautions for Correct Use

Please observe the following precautions to prevent failure to operate, malfunctions, or undesirable effects on product performance.

#### Installation Site

Install the product at a location where:

- It is not exposed to corrosive gases, dust, metal chips, or salt.
- The ambient operating temperature is within the range stipulated in the specifications.
- There are no sudden variations in temperature (no condensation).
- The ambient operating humidity is within the range stipulated in the specifications.
- No vibration or shock exceeding the values stipulated in the specifications is transmitted directly to the body of the product.
- It is not subject to splashing water, oil, or chemical substances.

#### Installation

- The product uses the 13.56-MHz frequency band to communicate with RF Tags. Some devices, such as some motors, inverters, and switching power supplies, generate electromagnetic waves (i.e., noise) that can affect communications with RF Tags. If any of these devices are nearby, communications with RF Tags may be affected or RF Tags may be destroyed. If the product is to be used near such devices, check the effects on communications before using the product.
- To minimize the general influence of noise, observe the following precautions:
  1. Ground any metallic material located around this device to 100Ω or less.
  2. Keep the product away from high voltage and heavy current.
- Do not pull on the cable.
- Do not use products that are not waterproof in misty environments.
- Do not subject the products to chemicals that adversely affect product materials.
- When installing the product, tighten screws to the following torque:

Controller:	1.2 N·m max
ID Sensor Unit:	0.4 N·m
V680-HS51 Antenna:	6 N·m
V680-HS52 Antenna:	40 N·m
V680-HS63 Antenna:	1.2 N·m
V680-HS65 Antenna:	1.2 N·m
V680-H01-V2 Antenna:	1.2 N·m
(Attach the enclosed Mounting Brackets)	
V680-D1KP66T/-D1KP66MT:	0.5 N·m
V680-D1KP66T-SP:	1.2 N·m
V680-D1KP54T:	0.3 to 0.5 N·m
V680-D2KF67/-D2KF67M:	0.6 N·m
V680-D8KF67/-D8KF67M:	0.6 N·m
V680-D8KF68/-D32KF68:	1.2 N·m

#### Communications with Host (V680-HAM91/-HAM81)

The I/O status may be unstable when the ID Controller is started.

After turning ON the power supply to the ID Controller, allow at least 1 second to elapse before performing control.

#### Storage

Store the product at a location where:

- It is not exposed to corrosive gases, dust, metal chips, or salt.
- The ambient storage temperature is within the range stipulated in the specifications.
- There are no sudden variations in temperature (no condensation).
- The ambient storage humidity is within the range stipulated in the specifications.
- No vibration or shock exceeding the values stipulated in the specifications is transmitted directly to the body of the product.
- It is not subject to splashing water, oil, or chemical substances.

#### Cleaning

Do not use thinner, benzene, acetone, or kerosene for cleaning.

Using these substances may dissolve the resin material and the case.

Dimensions

RF Tag

V680-D1KP52MT/-D2KF52M

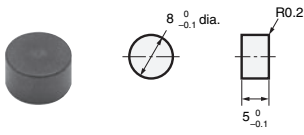

Case material	PPS resin
Filling	Epoxy resin

V680-D1KP53M

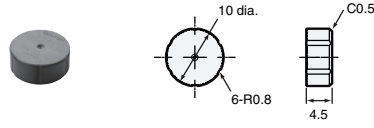

Case material	PPS resin
Filling	Epoxy resin

V680-D1KP54T

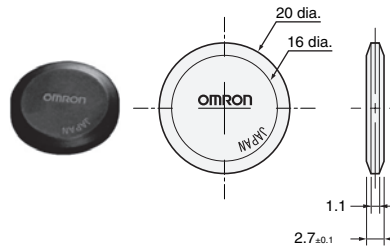

Case material	PPS resin
---------------	-----------

V680-D1KP66T/-D1KP66MT

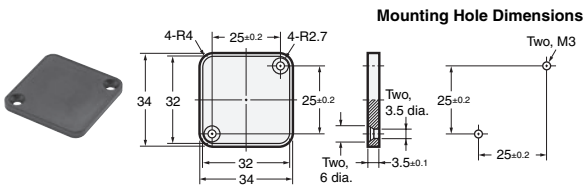

Case material	PPS resin
---------------	-----------

V680-D1KP66T-SP

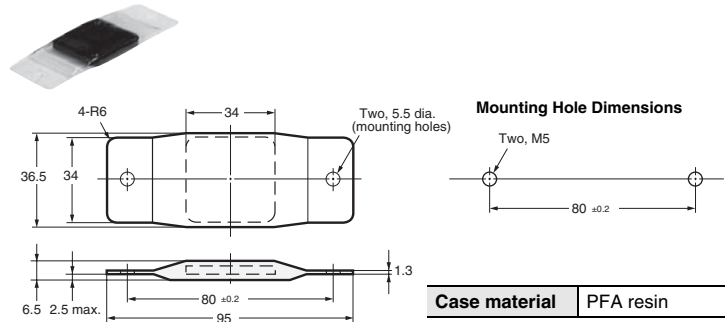

Case material	PFA resin
---------------	-----------

V680-D2KF67/-D2KF67M

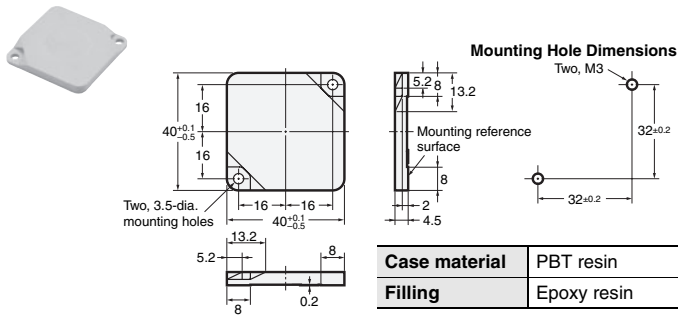

Case material	PBT resin
Filling	Epoxy resin

V680-D8KF67/-D8KF67M

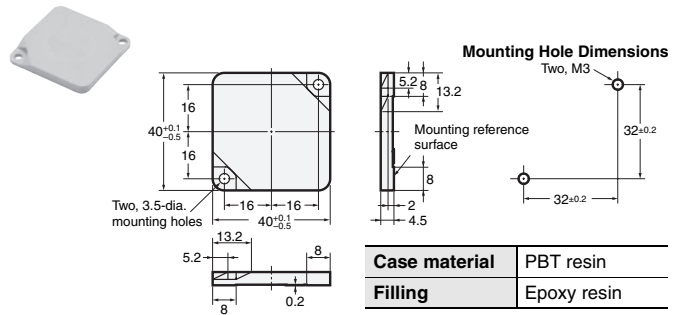

Case material	PBT resin
Filling	Epoxy resin

V680-D8KF68/-D32KF68

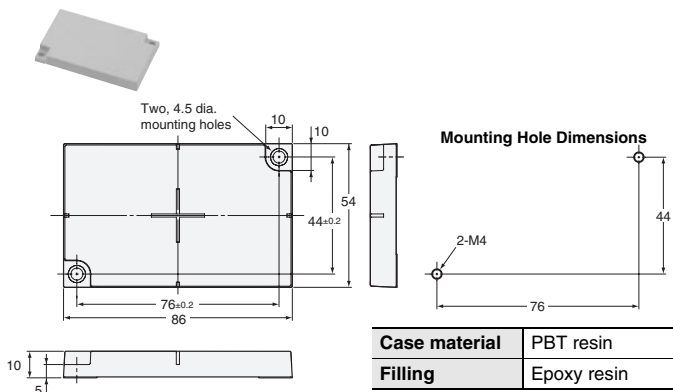

Case material	PBT resin
Filling	Epoxy resin

V680-D1KP58HT

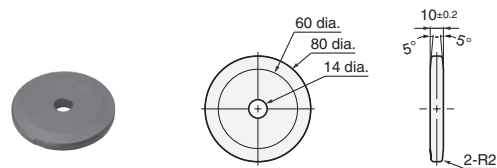

Coating	PPS resin
---------	-----------

V680-D1KP52M-BT01  
V680-D2KF52M-BT01

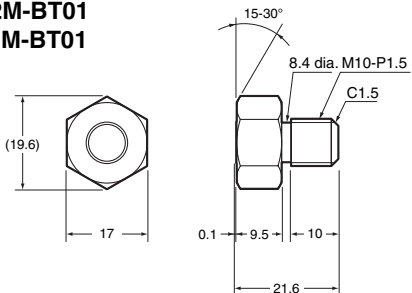

V680-D1KP52M-BT11  
V680-D2KF52M-BT11

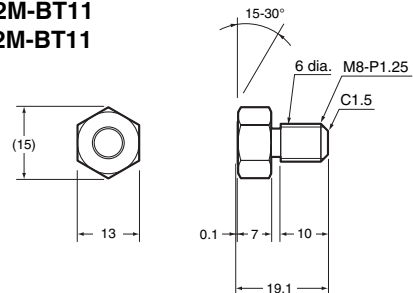

## Antenna with Detachable Amplifier Unit

### V680-HS52-W

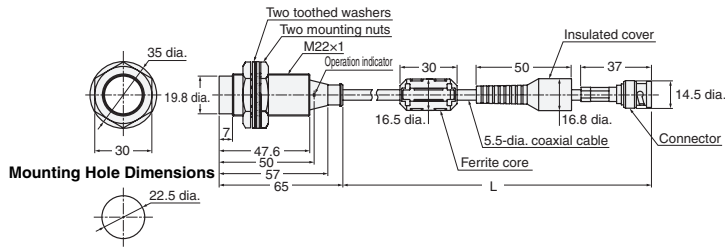

Cable length	L dimension
2 m	2,000 <sup>+100</sup> <sub>-50</sub>
12.5 m	12,500 <sup>+200</sup> <sub>-50</sub>
<b>Case material</b>	Brass
<b>Transmission surface</b>	ABS resin
<b>Filling</b>	Epoxy resin
<b>Cable</b>	PVC

### V680-HS52-R

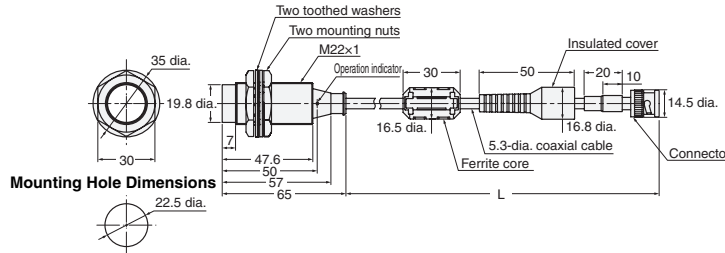

Cable length	L dimension
2 m	2,000 <sup>+100</sup> <sub>-50</sub>
12.5 m	12,500 <sup>+200</sup> <sub>-50</sub>
<b>Case material</b>	Brass
<b>Transmission surface</b>	ABS resin
<b>Filling</b>	Epoxy resin
<b>Cable</b>	PVC

### V680-HS51

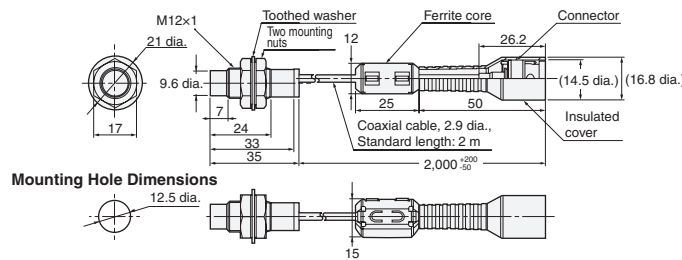

<b>Case material</b>	Brass
<b>Transmission surface</b>	ABS resin
<b>Filling</b>	Epoxy resin
<b>Cable</b>	PVC

### V680-HS63-W

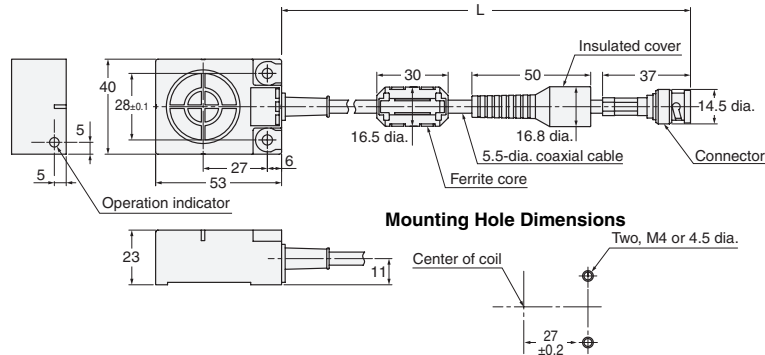

Cable length	L dimension
2 m	2,000 <sup>+100</sup> <sub>-50</sub>
12.5 m	12,500 <sup>+200</sup> <sub>-50</sub>
<b>Case material</b>	ABS resin
<b>Filling</b>	Epoxy resin
<b>Cable</b>	PVC

### V680-HS63-R

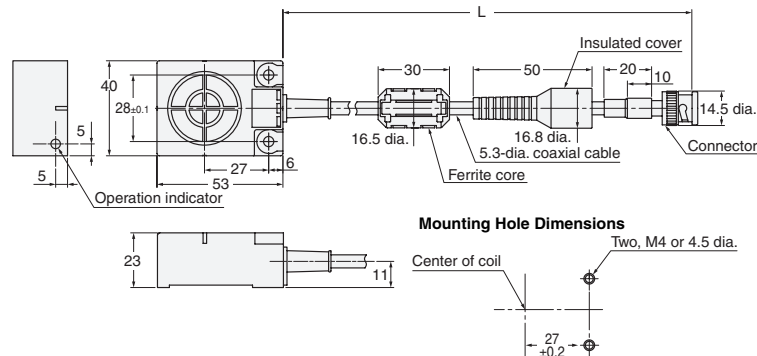

Cable length	L dimension
2 m	2,000 <sup>+100</sup> <sub>-50</sub>
12.5 m	12,500 <sup>+200</sup> <sub>-50</sub>
<b>Case material</b>	ABS resin
<b>Filling</b>	Epoxy resin
<b>Cable</b>	PVC

## V680-HS65-W

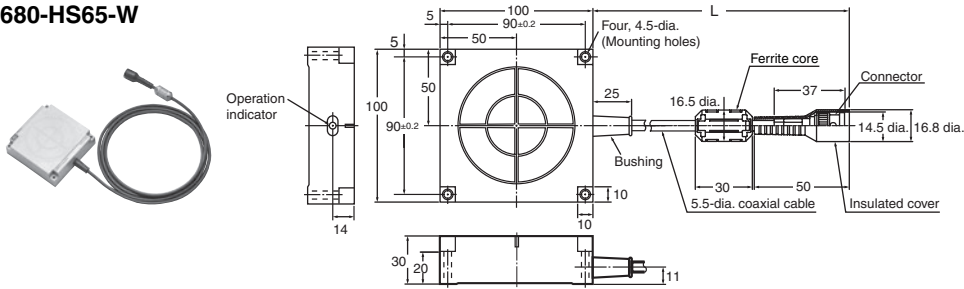

Cable length	L dimension
2 m	2,000 <sup>+100</sup> <sub>-50</sub>
12.5 m	12,500 <sup>+200</sup> <sub>-50</sub>

Case material	ABS resin
Filling	Epoxy resin
Cable	PVC (gray)

## V680-HS65-R

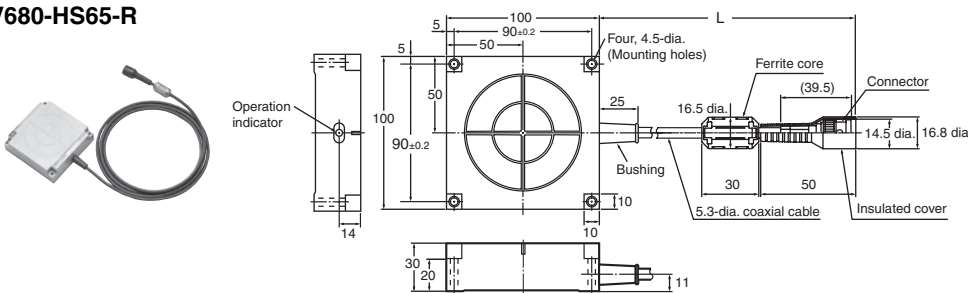

Cable length	L dimension
2 m	2,000 <sup>+100</sup> <sub>-50</sub>
12.5 m	12,500 <sup>+200</sup> <sub>-50</sub>

Case material	ABS resin
Filling	Epoxy resin
Cable	PVC (black)

## Antenna with Built-in Amplifier Unit

### V680-H01-V2

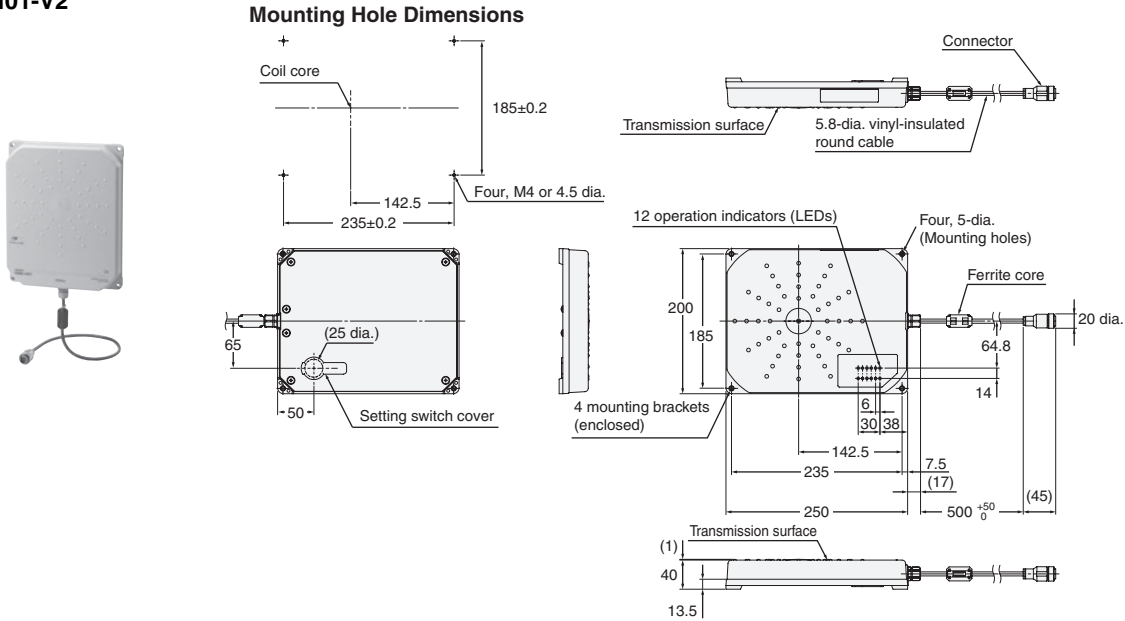

Case material	PC/ASA resin
Filling	Aluminum
Cable	PVC

## Amplifier Unit

### V680-HA63A/-HA63B

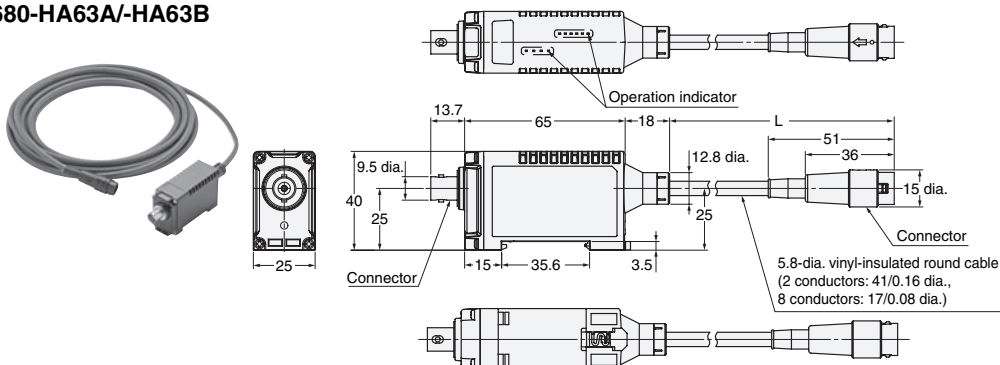

Cable length	L dimension
0.5 m	500 <sup>+100</sup> <sub>-50</sub>
5 m	5,000 <sup>+100</sup> <sub>-50</sub>
10 m	10,000 <sup>+200</sup> <sub>-100</sub>

Case material	PC resin
Filling	Epoxy resin
Cable	PVC

## ID Controller

### V680-CA5D01-V2/-CA5D02-V2

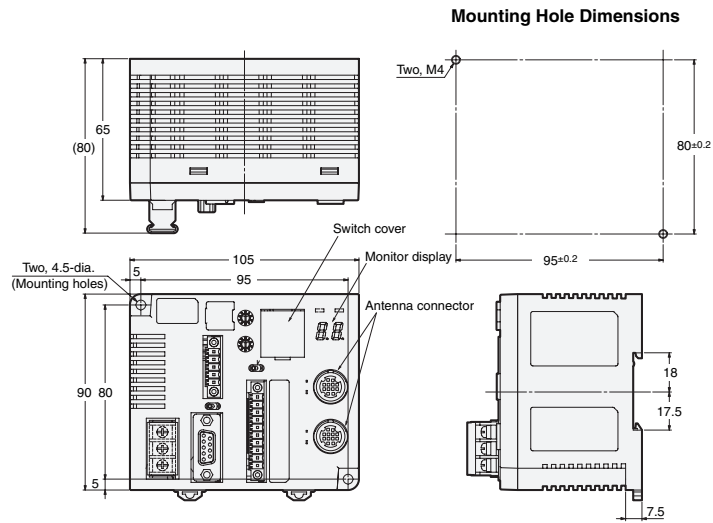

## ID Sensor Units

### CJ1W-V680C11

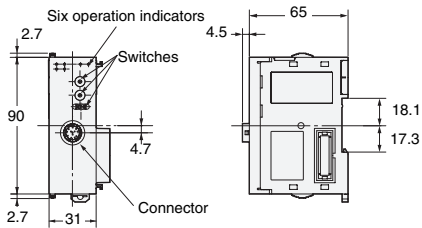

### CS1W-V680C11

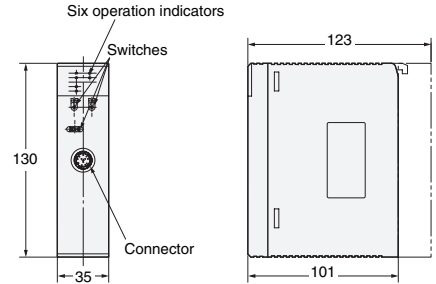

### CJ1W-V680C12

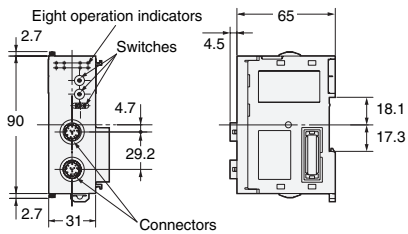

### CS1W-V680C12

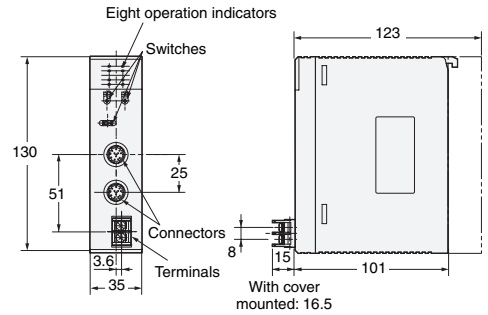

## Amplifier-integrated Controller (DeviceNet ID Slave/PROFIBUS ID Slave)

### V680-HAM42-DRT

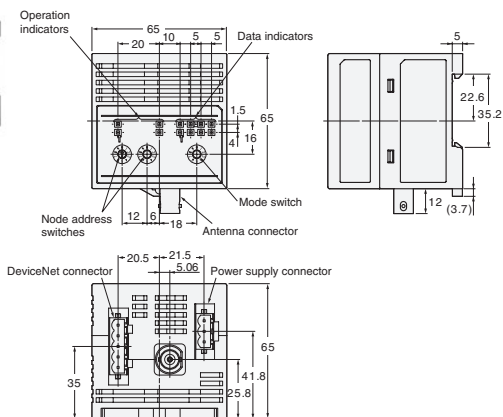

Case material PC+ABS resin

### V680-HAM42-PRT

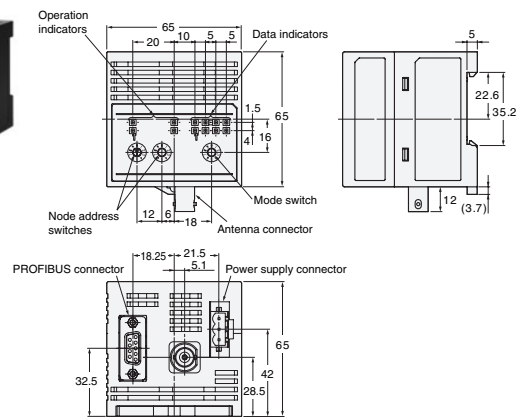

Case material PC+ABS resin

Amplifier-integrated Controllers (ID Flag Sensors)

V680-HAM91/-HAM81

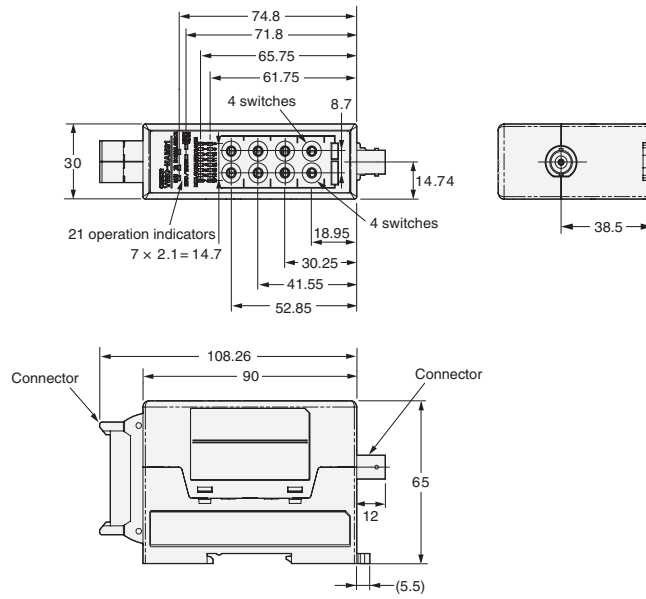

Case material	PC+ABS resin
---------------	--------------

Handheld Reader Writer

V680-CHUD

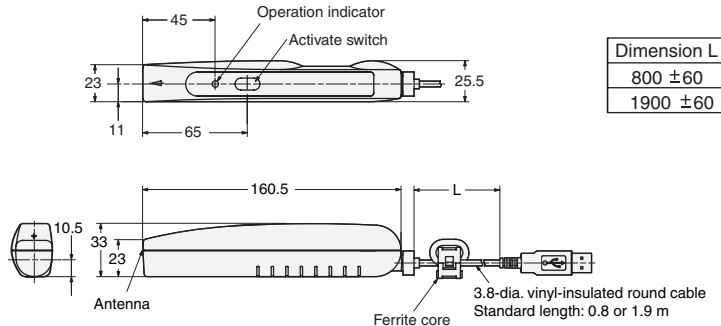

Case material	ABS resin
Cable	PVC

V680-CH1D

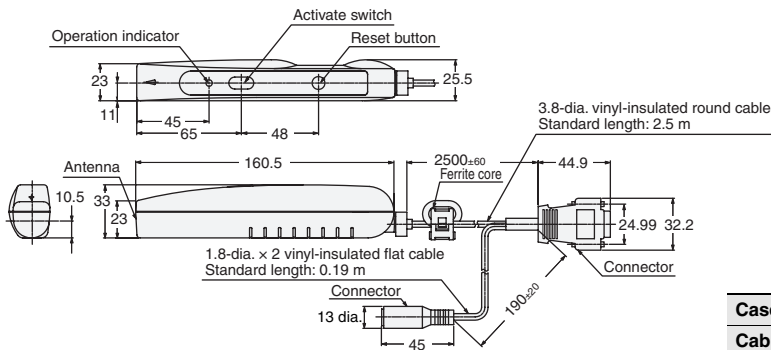

Case material	ABS resin
Cable	PVC

V680-CH1D-PSI

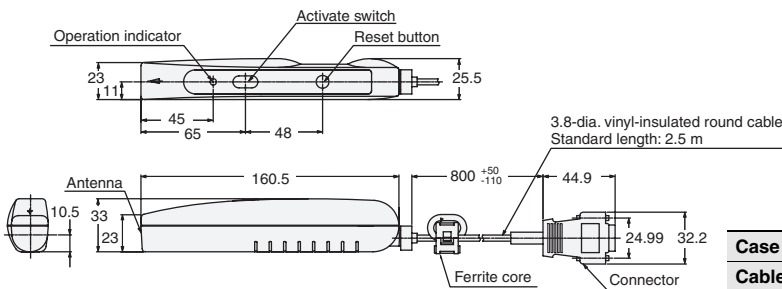

Case material	ABS resin
Cable	PVC



Interface Cables (Sold Separately)

V680-A60 2M/5M/10M

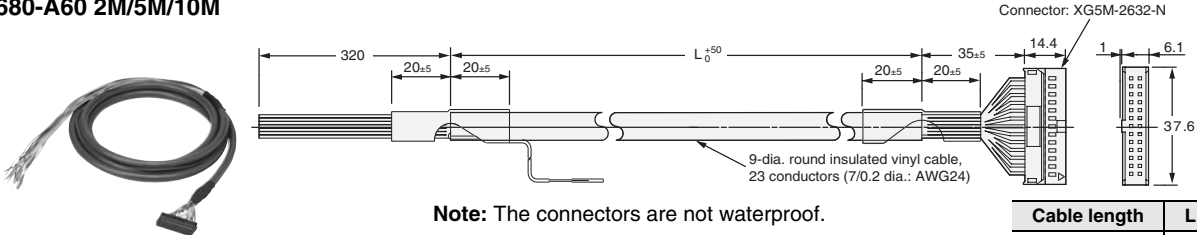

Note: The connectors are not waterproof.

Cable length	L dimension
2 m	2,000
5 m	5,000
10 m	10,000

AC Adapter

V600-A22

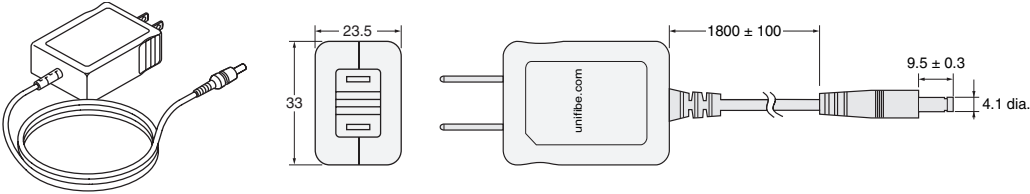

Handheld Terminal (Recommended)

Recommended Handheld Terminal  
Psion Teklogix model 7527S-G3-□□-S  
(V680-A-7527S-G3-□□-S)

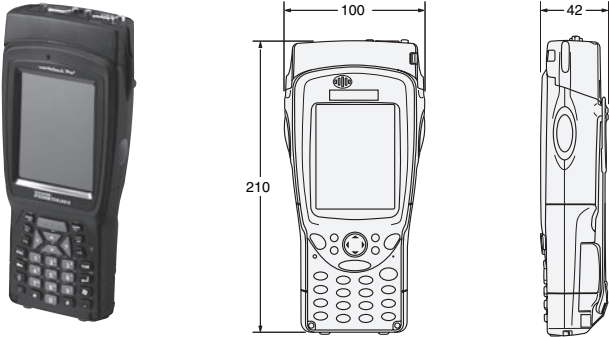

Accessories

V680-D1KP66T Attachments  
V600-A86

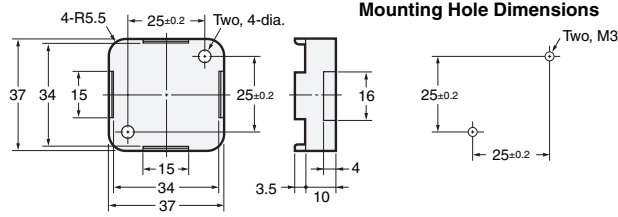

Case material	PPS resin
---------------	-----------

V680-D8KF68/-D32KF68 Attachments  
V680-A81

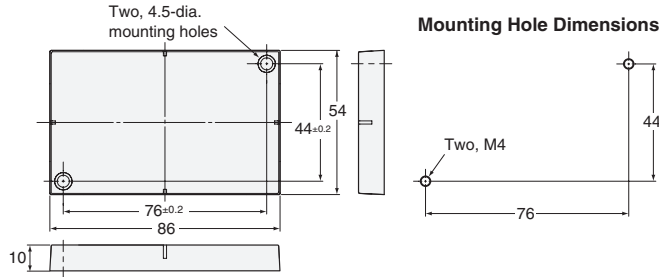

Case material	PBT resin
Filling	Epoxy resin

V680-D1KP58HT Attachments  
V680-A80

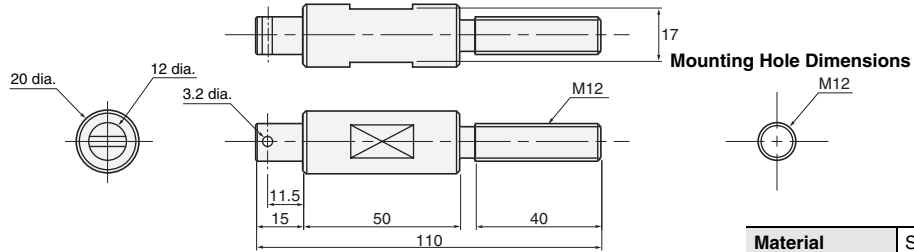

Material	Stainless steel
----------	-----------------

V680-D1KP54T Attachments  
V700-A80

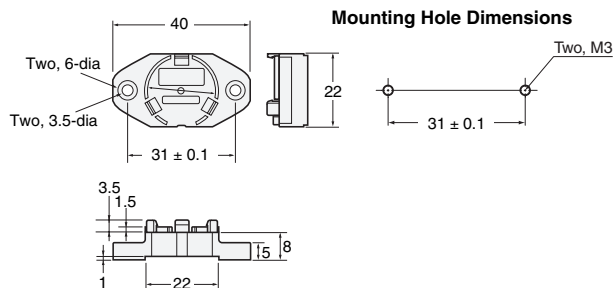

Amplifier Unit Special Extension Cable

- V700-A40 2M
- V700-A41 3M
- V700-A42 5M
- V700-A43 10M
- V700-A44 20M
- V700-A45 30M

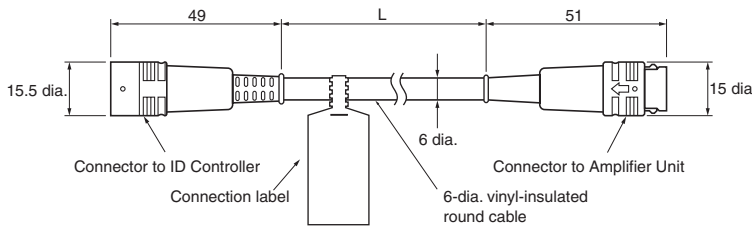

Cable length	L dimension
2 m	2,000±100
3 m	3,000±100
5 m	5,000±100
10 m	10,000±100
20 m	20,000±100
30 m	30,000±100
Material	PVC

V680-H01 Special Cables

- V700-A40-W 2M
- V700-A40-W 5M
- V700-A40-W 10M
- V700-A40-W 20M
- V700-A40-W 30M

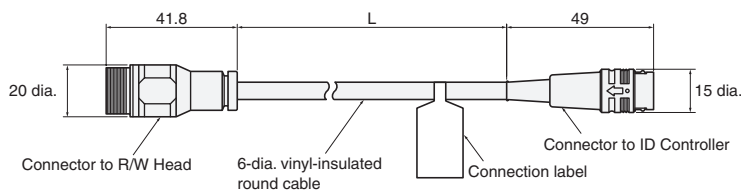

Cable length	L dimension
2 m	2,000±100
5 m	5,000±100
10 m	10,000±100
20 m	20,000±100
30 m	30,000±100
Material	PVC

## Read and Understand This Catalog

Please read and understand this catalog before purchasing the products. Please consult your OMRON representative if you have any questions or comments.

## Warranty and Limitations of Liability

### WARRANTY

OMRON's exclusive warranty is that the products are free from defects in materials and workmanship for a period of one year (or other period if specified) from date of sale by OMRON.

OMRON MAKES NO WARRANTY OR REPRESENTATION, EXPRESS OR IMPLIED, REGARDING NON-INFRINGEMENT, MERCHANTABILITY, OR FITNESS FOR PARTICULAR PURPOSE OF THE PRODUCTS. ANY BUYER OR USER ACKNOWLEDGES THAT THE BUYER OR USER ALONE HAS DETERMINED THAT THE PRODUCTS WILL SUITABLY MEET THE REQUIREMENTS OF THEIR INTENDED USE. OMRON DISCLAIMS ALL OTHER WARRANTIES, EXPRESS OR IMPLIED.

### LIMITATIONS OF LIABILITY

OMRON SHALL NOT BE RESPONSIBLE FOR SPECIAL, INDIRECT, OR CONSEQUENTIAL DAMAGES, LOSS OF PROFITS OR COMMERCIAL LOSS IN ANY WAY CONNECTED WITH THE PRODUCTS, WHETHER SUCH CLAIM IS BASED ON CONTRACT, WARRANTY, NEGLIGENCE, OR STRICT LIABILITY.

In no event shall the responsibility of OMRON for any act exceed the individual price of the product on which liability is asserted.

IN NO EVENT SHALL OMRON BE RESPONSIBLE FOR WARRANTY, REPAIR, OR OTHER CLAIMS REGARDING THE PRODUCTS UNLESS OMRON'S ANALYSIS CONFIRMS THAT THE PRODUCTS WERE PROPERLY HANDLED, STORED, INSTALLED, AND MAINTAINED AND NOT SUBJECT TO CONTAMINATION, ABUSE, MISUSE, OR INAPPROPRIATE MODIFICATION OR REPAIR.

## Application Considerations

### SUITABILITY FOR USE

OMRON shall not be responsible for conformity with any standards, codes, or regulations that apply to the combination of products in the customer's application or use of the products.

At the customer's request, OMRON will provide applicable third party certification documents identifying ratings and limitations of use that apply to the products. This information by itself is not sufficient for a complete determination of the suitability of the products in combination with the end product, machine, system, or other application or use.

The following are some examples of applications for which particular attention must be given. This is not intended to be an exhaustive list of all possible uses of the products, nor is it intended to imply that the uses listed may be suitable for the products:

- Outdoor use, uses involving potential chemical contamination or electrical interference, or conditions or uses not described in this catalog.
- Nuclear energy control systems, combustion systems, railroad systems, aviation systems, medical equipment, amusement machines, vehicles, safety equipment, and installations subject to separate industry or government regulations.
- Systems, machines, and equipment that could present a risk to life or property.

Please know and observe all prohibitions of use applicable to the products.

NEVER USE THE PRODUCTS FOR AN APPLICATION INVOLVING SERIOUS RISK TO LIFE OR PROPERTY WITHOUT ENSURING THAT THE SYSTEM AS A WHOLE HAS BEEN DESIGNED TO ADDRESS THE RISKS, AND THAT THE OMRON PRODUCTS ARE PROPERLY RATED AND INSTALLED FOR THE INTENDED USE WITHIN THE OVERALL EQUIPMENT OR SYSTEM.

### PROGRAMMABLE PRODUCTS

OMRON shall not be responsible for the user's programming of a programmable product, or any consequence thereof.

## Disclaimers

### CHANGE IN SPECIFICATIONS

Product specifications and accessories may be changed at any time based on improvements and other reasons.

It is our practice to change model numbers when published ratings or features are changed, or when significant construction changes are made. However, some specifications of the products may be changed without any notice. When in doubt, special model numbers may be assigned to fix or establish key specifications for your application on your request. Please consult with your OMRON representative at any time to confirm actual specifications of purchased products.

### DIMENSIONS AND WEIGHTS

Dimensions and weights are nominal and are not to be used for manufacturing purposes, even when tolerances are shown.

### PERFORMANCE DATA

Performance data given in this catalog is provided as a guide for the user in determining suitability and does not constitute a warranty. It may represent the result of OMRON's test conditions, and the users must correlate it to actual application requirements. Actual performance is subject to the OMRON Warranty and Limitations of Liability.

### ERRORS AND OMISSIONS

The information in this document has been carefully checked and is believed to be accurate; however, no responsibility is assumed for clerical, typographical, or proofreading errors, or omissions.

2012.2

In the interest of product improvement, specifications are subject to change without notice.

**OMRON Corporation**  
Industrial Automation Company

<http://www.ia.omron.com/>

(c)Copyright OMRON Corporation 2012 All Right Reserved.



Компания «ЭлектроПласт» предлагает заключение долгосрочных отношений при поставках импортных электронных компонентов на взаимовыгодных условиях!

Наши преимущества:

- Оперативные поставки широкого спектра электронных компонентов отечественного и импортного производства напрямую от производителей и с крупнейших мировых складов;
- Поставка более 17-ти миллионов наименований электронных компонентов;
- Поставка сложных, дефицитных, либо снятых с производства позиций;
- Оперативные сроки поставки под заказ (от 5 рабочих дней);
- Экспресс доставка в любую точку России;
- Техническая поддержка проекта, помощь в подборе аналогов, поставка прототипов;
- Система менеджмента качества сертифицирована по Международному стандарту ISO 9001;
- Лицензия ФСБ на осуществление работ с использованием сведений, составляющих государственную тайну;
- Поставка специализированных компонентов (Xilinx, Altera, Analog Devices, Intersil, Interpoint, Microsemi, Aeroflex, Peregrine, Syfer, Eurofarad, Texas Instrument, Miteq, Cobham, E2V, MA-COM, Hittite, Mini-Circuits, General Dynamics и др.);

Помимо этого, одним из направлений компании «ЭлектроПласт» является направление «Источники питания». Мы предлагаем Вам помощь Конструкторского отдела:

- Подбор оптимального решения, техническое обоснование при выборе компонента;
- Подбор аналогов;
- Консультации по применению компонента;
- Поставка образцов и прототипов;
- Техническая поддержка проекта;
- Защита от снятия компонента с производства.



#### Как с нами связаться

**Телефон:** 8 (812) 309 58 32 (многоканальный)

**Факс:** 8 (812) 320-02-42

**Электронная почта:** [org@eplast1.ru](mailto:org@eplast1.ru)

**Адрес:** 198099, г. Санкт-Петербург, ул. Калинина, дом 2, корпус 4, литера А.