

Sound Processor Series for Car Audio

Sound Processors with Built-in 2-band Equalizer



BD37522FS, BD37523FS

No.10085EAT04

●Description

BD37522FS, BD37523FS are sound processors built-in 2-band equalizer for car audio. The functions are stereo 5ch input selector, input-gain control, main volume, loudness, 5ch fader volume (About BD37522FS, 4ch fader volume are available). Moreover, "Advanced switch circuit", that is ROHM original technology, can reduce various switching noise (ex. No-signal, low frequency likes 20Hz & large signal inputs). "Advanced switch" makes control of microcomputer easier, and can construct high quality car audio system.

●Features

- 1) Reduce switching noise of input gain control, mute, main volume, fader volume, bass, treble, loudness by using advanced switch circuit [Possible to control all steps]
- 2) Built-in 1 differential input selector and 4 single-ended input selectors
- 3) Built-in ground isolation amplifier inputs, ideal for external stereo input.
- 4) Built-in input gain controller reduces switching noise for volume of a portable audio input.
- 5) Decrease the number of external components by built-in 2-band equalizer filter, LPF for subwoofer (BD37523FS), loudness filter. And, possible to control Q, Gv, fo of 2-band equalizer and fc(BD37523FS) of LPF, Gv of loudness by I²C BUS control freely
- 6) It is possible for the bass, treble to the gain adjustment quantity of ±20dB and 1 dB step gain adjustment.
- 7) Terminals for the subwoofer outputs are equipped.
- 8) Bi-CMOS process is suitable for the design of low current and low energy. And it provides more quality for small scale regulator and heat in a set.
- 9) Package is SSOP-A24. Putting input-terminals together and output-terminals together can make PCB layout easier and can makes area of PCB smaller.
- 10) It is possible to control by 3.3V / 5V for I²C BUS.

●Applications

It is the optimal for the car audio. Besides, it is possible to use for the audio equipment of mini Compo, micro Compo, TV etc with all kinds.

● Line up matrix

Function	BD37522FS	BD37523FS	Specifications
Input selector	○	○	<ul style="list-style-type: none"> • Stereo 4 input • Differential 1 input
Input gain	○	○	<ul style="list-style-type: none"> • 0~20dB (1dB step) • Possible to use "Advanced switch" for prevention of switching noise.
Mute	○	○	<ul style="list-style-type: none"> • Possible to use "Advanced switch" for prevention of switching noise.
Volume	○	○	<ul style="list-style-type: none"> • +15dB~-79dB (1dB step) , -∞ • Possible to use "Advanced switch" for prevention of switching noise.
Bass	○	○	<ul style="list-style-type: none"> • -20~+20dB (1dB step) • Q=0.5, 1, 1.5, 2 variable • fo=60, 80, 100, 120Hz • Possible to use "Advanced switch" at changing gain
Treble	○	○	<ul style="list-style-type: none"> • -20~+20dB (1dB step) • Q=0.75, 1.25 variable • fo=7.5k, 10k, 12.5k, 15kHz • Possible to use "Advanced switch" at changing gain
Fader	○	○	<ul style="list-style-type: none"> • +15dB~-79dB(1dB step), -∞dB(BD37522FS : 0dB~-79dB, -∞dB) • Possible to use "Advanced switch" for prevention of switching noise.
Loudness	○	○	<ul style="list-style-type: none"> • 0dB~20dB(1dB step) • fo=800Hz • Possible to use "Advanced switch" for prevention of switching noise.
LPF	×	○	<ul style="list-style-type: none"> • fc=55/85/120/160Hz, pass • Phase shift (0°/180°)

● Absolute maximum ratings (Ta=25°C)

Item	Symbol	Rating	Unit
Power supply Voltage	VCC	10.0	V
Input voltage	Vin	VCC+0.3~GND-0.3	V
Power Dissipation	Pd	1000 ※1	mW
Storage Temperature	Tastg	-55~+150	°C

※This value decreases 8mW/°C for Ta=25°C or more.

ROHM standard board shall be mounted.

Thermal resistance $\theta_{ja} = 125(^{\circ}\text{C}/\text{W})$

ROHM Standard board

Size : 70×70×1.6(mm)

Material : A FR4 grass epoxy board(3% or less of copper foil area)

● Operating conditions

Item	Symbol	MIN	TYP	MAX	Unit
Power supply Voltage	VCC	7.0	—	9.5	V
Temperature	Topr	-40	—	+85	°C

●Electrical characteristics

(Unless specified particularly, Ta=25°C, VCC=8.5V, f=1kHz, Vin=1Vrms, Rg=600Ω, RL=10kΩ, A1 input, Input gain 0dB, Mute off, Volume 0dB, Tone control 0dB, Loudness 0dB, LPF OFF (BD37523FS), Fader 0dB)

BLOCK	Item	Symbol	Limit			Unit	Condition
			Min.	Typ.	Max.		
GENERAL	Current upon no signal	I _Q	—	38	48	mA	No signal
	Voltage gain	G _V	-1.5	0	+1.5	dB	G _V =20log(V _{OUT} /V _{IN})
	Channel balance	CB	-1.5	0	+1.5	dB	CB = G _{V1} -G _{V2}
	Total harmonic distortion 1 (FRONT,REAR)		—	0.001	0.05	%	V _{OUT} =1Vrms BW=400-30KHz
	Total harmonic distortion 2 (SUBWOOFER) (BD37523FS)	THD+N2	—	0.002	0.05	%	V _{OUT} =1Vrms BW=400-30KHz
	Output noise voltage 1 (FRONT,REAR) *	V _{NO1}	—	3.8	15	μVrms	R _g = 0Ω BW = IHF-A
	Output noise voltage 2 (SUBWOOFER) * (BD37523FS)	V _{NO2}	—	4.8	15	μVrms	R _g = 0Ω BW = IHF-A
	Residual output noise voltage *	V _{NOR}	—	1.8	10	μVrms	Fader = -∞dB R _g = 0Ω BW = IHF-A
	Cross-talk between channels *	CTC	—	-100	-90	dB	R _g = 0Ω CTC=20log(V _{OUT} /V _{IN}) BW = IHF-A
	Ripple rejection	RR	—	-70	-40	dB	f=1kHz VRR=100mVrms RR=20log(VCC IN/VOUT)
INPUT SELECTOR	Input impedance(A, B)	R _{IN S}	70	100	130	kΩ	
	Input impedance (C,D,E)	R _{IN D}	175	250	325	kΩ	
	Maximum input voltage	V _{IM}	2.1	2.3	—	Vrms	V _{IM} at THD+N(V _{OUT})=1% BW=400-30KHz
	Cross-talk between selectors *	CTS	—	-100	-90	dB	R _g = 0Ω CTS=20log(V _{OUT} /V _{IN}) BW = IHF-A
	Common mode rejection ratio *	CMRR	50	65	—	dB	CP1 and CN input CP2 and CN input CMRR=20log(V _{IN} /V _{OUT}) BW = IHF-A
INPUT GAIN	Minimum input gain	G _{IN MIN}	-2	0	+2	dB	Input gain 0dB V _{IN} =100mVrms G _{IN} =20log(V _{OUT} /V _{IN})
	Maximum input gain	G _{IN MAX}	+18	+20	+22	dB	Input gain +20dB V _{IN} =100mVrms G _{IN} =20log(V _{OUT} /V _{IN})
	Gain set error	G _{IN ERR}	-2	0	+2	dB	G _{AIN} =+20~-+1dB
MUTE	Mute attenuation *	G _{MUTE}	—	-105	-85	dB	Mute ON G _{mute} =20log(V _{OUT} /V _{IN}) BW = IHF-A
VOLUME	Maximum gain	G _{V MAX}	+13	+15	+17	dB	Volume = +15dB V _{IN} =100mVrms G _V =20log(V _{OUT} /V _{IN})
	Maximum attenuation *	G _{V MIN}	—	-100	-85	dB	Volume = -∞dB G _V =20log(V _{OUT} /V _{IN}) BW = IHF-A
	Attenuation set error 1	G _{V ERR1}	-2	0	+2	dB	G _{AIN} & ATT=+15dB~-15dB
	Attenuation set error 2	G _{V ERR2}	-3	0	+3	dB	ATT=-16dB~-47dB
	Attenuation set error 3	G _{V ERR3}	-4	0	+4	dB	ATT=-48dB~-79dB

BLOCK	Item	Symbol	Limit			Unit	Condition
			Min.	Typ.	Max.		
BASS	Maximum boost gain	$G_{B\text{BST}}$	18	20	22	dB	Gain=+20dB f=100Hz VIN=100mVrms $G_B=20\log(V_{OUT}/V_{IN})$
	Maximum cut gain	$G_{B\text{CUT}}$	-22	-20	-18	dB	Gain=-20dB f=100Hz VIN=2Vrms $G_B=20\log(V_{OUT}/V_{IN})$
	Gain set error	$G_{B\text{ERR}}$	-2	0	2	dB	Gain=-20~+20dB f=100Hz
TREBLE	Maximum boost gain	$G_{T\text{BST}}$	17	20	23	dB	Gain=+20dB f=10kHz VIN=100mVrms $G_T=20\log(V_{OUT}/V_{IN})$
	Maximum cut gain	$G_{T\text{CUT}}$	-23	-20	-17	dB	Gain=-20dB f=10kHz VIN=2Vrms $G_T=20\log(V_{OUT}/V_{IN})$
	Gain set error	$G_{T\text{ERR}}$	-2	0	2	dB	Gain=-20~+20dB f=10kHz
FADER / SUBWOOFER	Maximum boost gain (BD37523FS)	$G_{F\text{BST}}$	+13	+15	+17	dB	Fader=+15dB VIN=100mVrms $G_F=20\log(V_{OUT}/V_{IN})$
	Maximum attenuation *	$G_{F\text{MIN}}$	—	-100	-90	dB	Fader = -∞dB $G_F=20\log(V_{OUT}/V_{IN})$ BW = IHF-A
	Gain set error (BD37523FS)	$G_{F\text{ERR}}$	-2	0	+2	dB	Gain=+15~+1dB
	Attenuation set error 1	$G_{F\text{ERR}1}$	-2	0	2	dB	ATT=-1~-15dB
	Attenuation set error 2	$G_{F\text{ERR}2}$	-3	0	3	dB	ATT=-16~-47dB
	Attenuation set error 3	$G_{F\text{ERR}3}$	-4	0	4	dB	ATT=-48~-79dB
	Output impedance	R_{OUT}	-	—	50	Ω	VIN=100mVrms
Maximum output voltage	V_{OM}	2	2.2	—	Vrms	THD+N=1% BW=400-30KHz	
LOUDNESS	Maximum gain	$G_{L\text{MAX}}$	17	20	23	dB	Gain 20dB VIN=100mVrms $G_L=20\log(V_{OUT}/V_{IN})$
	Gain set error	$G_{L\text{ERR}}$	-2	0	2	dB	GAIN=+20~+1dB

VP-9690A(Average value detection, effective value display) filter by Matsushita Communication is used for * measurement.

Phase between input / output is same.

●Electrical characteristic curves (Reference data)

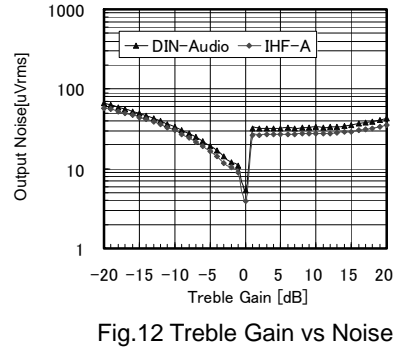
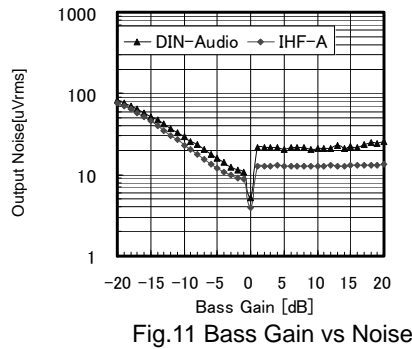
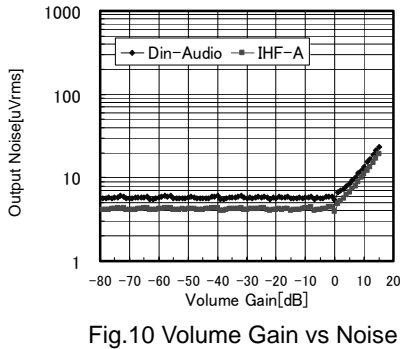
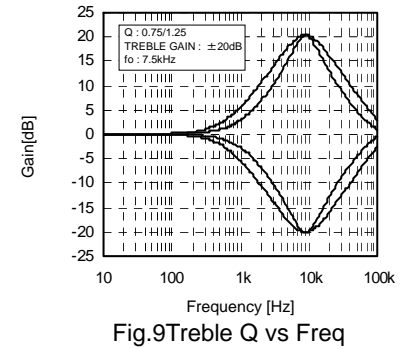
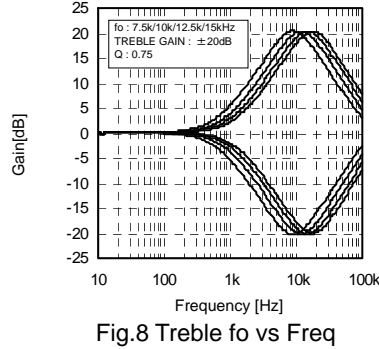
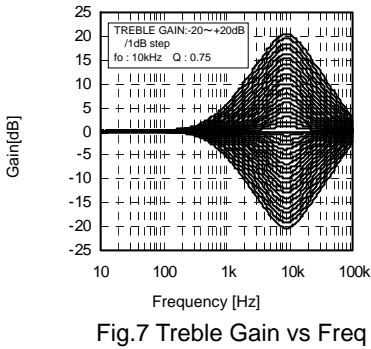
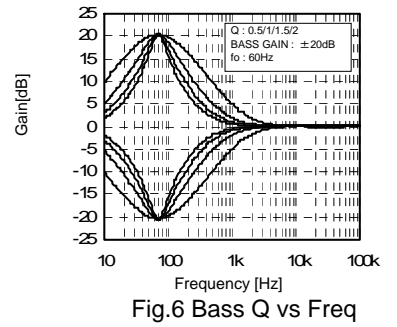
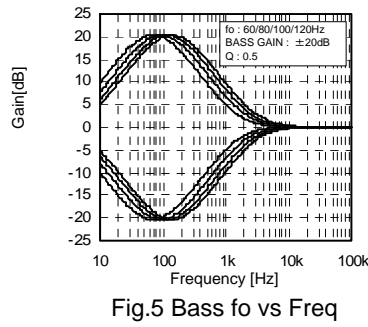
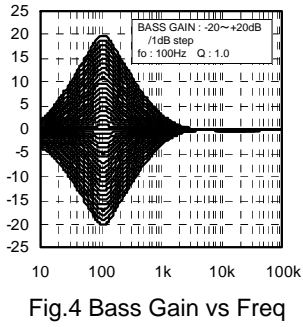
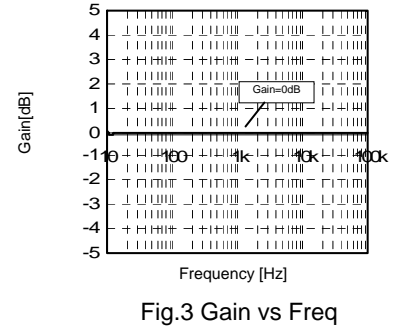
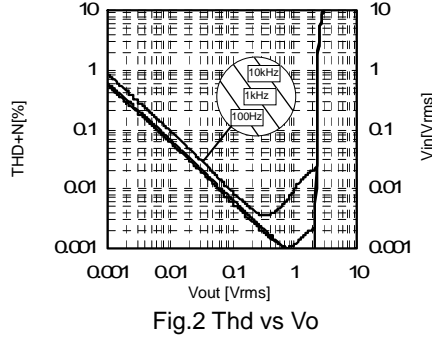
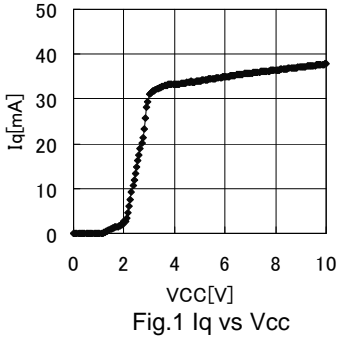

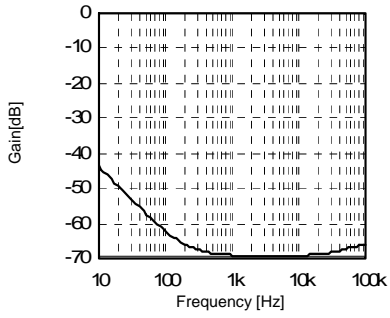

Fig.13 CMRR vs Freq

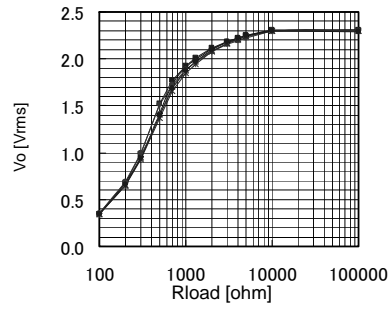

Fig.14 Rload vs Vo

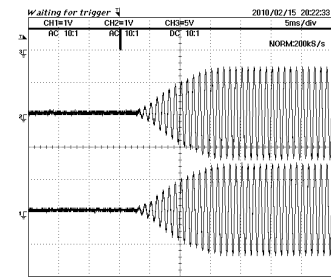

Fig.15 Advanced Switch 1

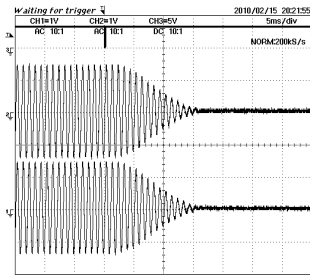

Fig.16 Advanced Switch 2

●Block diagram and pin configuration

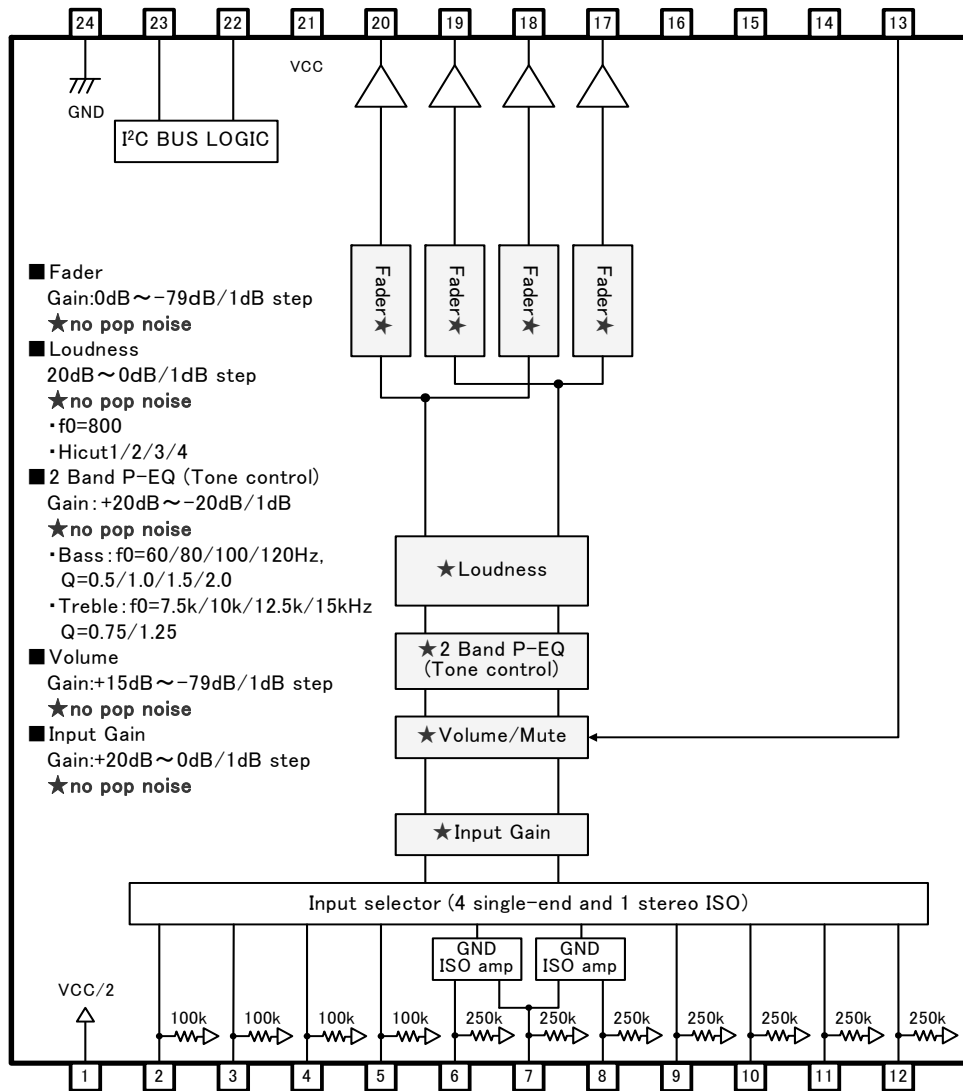

Fig.17 BD37522FS

Descriptions of terminal

Terminal No.	Terminal Name	Description	Terminal No.	Terminal Name	Description
1	FIL	VCC/2 terminal	13	MUTE	External compulsory mute terminal
2	A1	A input terminal of 1ch	14	TEST1	Test Pin
3	A2	A input terminal of 2ch	15	TEST2	Test Pin
4	B1	B input terminal of 1ch	16	TEST3	Test Pin
5	B2	B input terminal of 2ch	17	OUTR2	Rear output terminal of 2ch
6	CP1	C positive input terminal of 1ch	18	OUTR1	Rear output terminal of 1ch
7	CN	C negative input terminal	19	OUTF2	Front output terminal of 2ch
8	CP2	C positive input terminal of 2ch	20	OUTF1	Front output terminal of 1ch
9	D1	D input terminal of 1ch	21	VCC	Power supply terminal
10	D2	D input terminal of 2ch	22	SCL	I ² C Communication clock terminal
11	E1	E input terminal of 1ch	23	SDA	I ² C Communication data terminal
12	E2	E input terminal of 2ch	24	GND	GND terminal

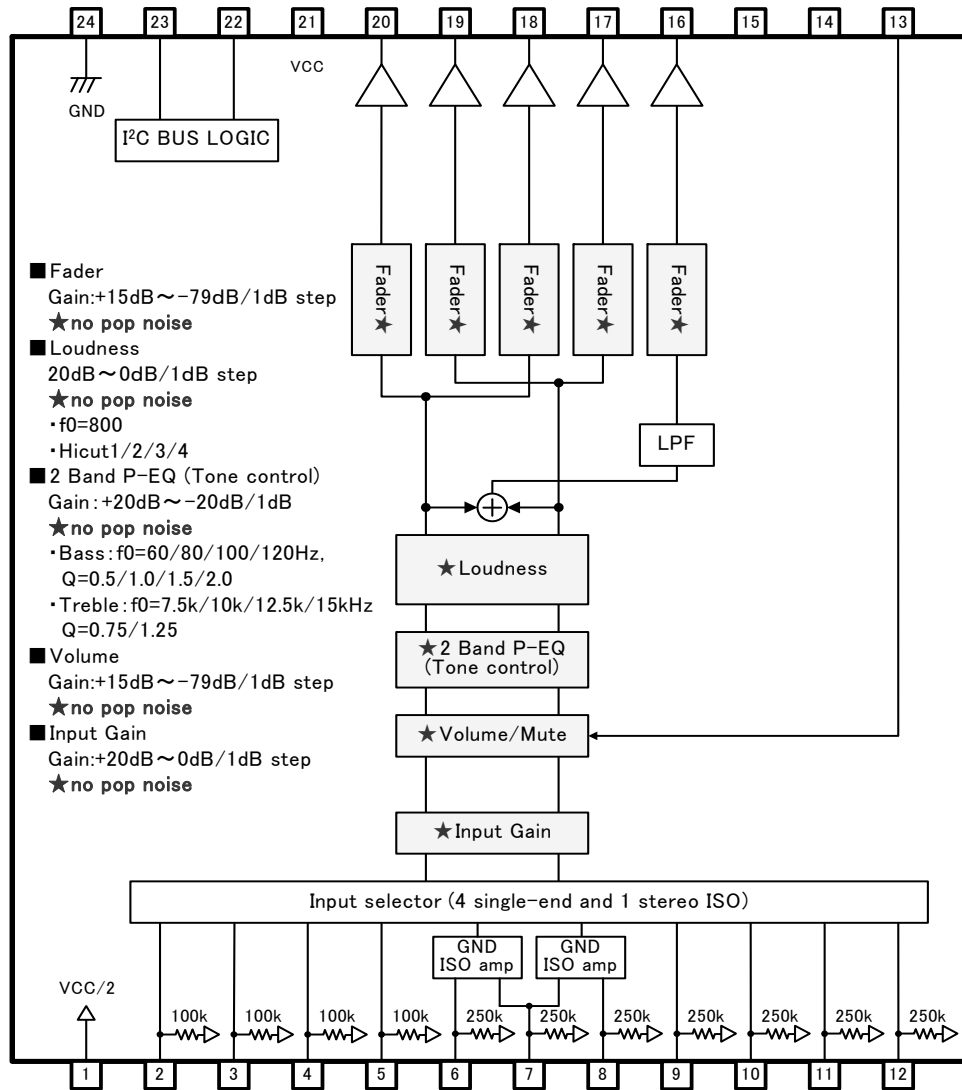

Fig.18 BD37523FS

Descriptions of terminal

Terminal No.	Terminal Name	Description	Terminal No.	Terminal Name	Description
1	FIL	VCC/2 terminal	13	MUTE	External compulsory mute terminal
2	A1	A input terminal of 1ch	14	TEST1	Test Pin
3	A2	A input terminal of 2ch	15	TEST2	Test Pin
4	B1	B input terminal of 1ch	16	OUTS	Subwoofer output terminal
5	B2	B input terminal of 2ch	17	OUTR2	Rear output terminal of 2ch
6	CP1	C positive input terminal of 1ch	18	OUTR1	Rear output terminal of 1ch
7	CN	C negative input terminal	19	OUTF2	Front output terminal of 2ch
8	CP2	C positive input terminal of 2ch	20	OUTF1	Front output terminal of 1ch
9	D1	D input terminal of 1ch	21	VCC	Power supply terminal
10	D2	D input terminal of 2ch	22	SCL	I ² C Communication clock terminal
11	E1	E input terminal of 1ch	23	SDA	I ² C Communication data terminal
12	E2	E input terminal of 2ch	24	GND	GND terminal

● Timing Chart

CONTROL SIGNAL SPECIFICATION

(1) Electrical specifications and timing for bus lines and I/O stages

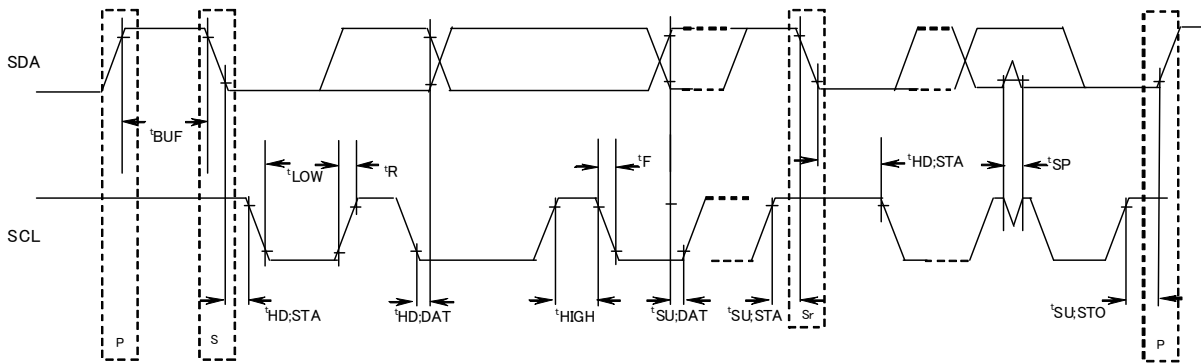

Fig. 19 Definition of timing on the I²C-bus

Table 1 Characteristics of the SDA and SCL bus lines for I²C-bus devices
(Unless specified particularly, Ta=25°C, VCC=8.5V)

Parameter	Symbol	Fast-mode I ² C-bus		Unit
		Min.	Max.	
1 SCL clock frequency	f SCL	0	400	kHz
2 Bus free time between a STOP and START condition	tBUF	1.3	—	μs
3 Hold time (repeated) START condition. After this period, the first clock pulse is generated	tHD:STA	0.6	—	μs
4 LOW period of the SCL clock	tLOW	1.3	—	μs
5 HIGH period of the SCL clock	tHIGH	0.6	—	μs
6 Set-up time for a repeated START condition	tSU:STA	0.6	—	μs
7 Data hold time:	tHD:DAT	0.06*	—	μs
8 Data set-up time	tSU:DAT	120	—	ns
9 Set-up time for STOP condition	tSU:STO	0.6	—	μs

All values referred to VIH min. and VIL max. Levels (see Table 2).

* A device must internally provide a hold time of at least 300 ns for the SDA signal (referred to the VIH min. of the SCL signal) in order to bridge the undefined region of the falling edge of SCL.
About 7(tHD;DAT), 8(tSU;DAT), make it the setup which a margin is fully in .

Table 2 Characteristics of the SDA and SCL I/O stages for I²C-bus devices

Parameter	Symbol	Fast-mode devices		Unit
		Min.	Max.	
10 LOW level input voltage:	V _{IL}	-0.3	1	V
11 HIGH level input voltage:	V _{IH}	2.3	5	V
12 Pulse width of spikes which must be suppressed by the input filter.	t _{SP}	0	50	ns
13 LOW level output voltage: at 3mA sink current	V _{OL1}	0	0.4	V
14 Input current each I/O pin with an input voltage between 0.4V and 4.5V.	I _i	-10	10	μA

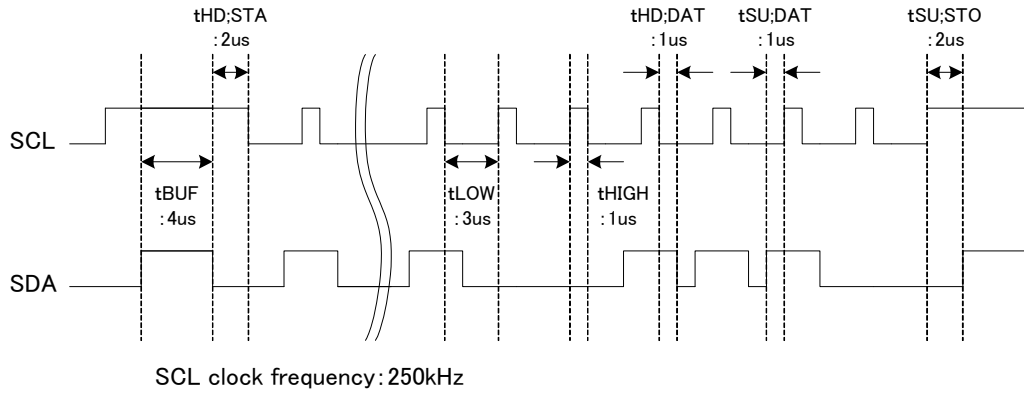

Fig. 20 A command timing example in the I2C data transmission

(2) I²C BUS FORMAT

MSB	LSB	MSB	LSB	MSB	LSB		
S	Slave Address	A	Select Address	A	Data	A	P
1bit	8bit	1bit	8bit	1bit	8bit	1bit	1bit

- S = Start conditions (Recognition of start bit)
- Slave Address = Recognition of slave address. 7 bits in upper order are voluntary. The least significant bit is "L" due to writing.
- A = ACKNOWLEDGE bit (Recognition of acknowledgement)
- Select Address = Select every of volume, bass and treble.
- Data = Data on every volume and tone.
- P = Stop condition (Recognition of stop bit)

(3) I²C BUS Interface Protocol

1) Basic form

S	Slave Address	A	Select Address	A	Data	A	P
MSB	LSB	MSB	LSB	MSB	LSB		

2) Automatic increment (Select Address increases (+1) according to the number of data.

S	Slave Address	A	Select Address	A	Data1	A	Data2	A	····	DataN	A	P
MSB	LSB	MSB	LSB	MSB	LSB	MSB	LSB	MSB	LSB	MSB	LSB	

- (Example) ①Data1 shall be set as data of address specified by Select Address.
 ②Data2 shall be set as data of address specified by Select Address +1.
 ③DataN shall be set as data of address specified by Select Address +N-1.

3) Configuration unavailable for transmission (In this case, only Select Address1 is set.

S	Slave Address	A	Select Address1	A	Data	A	Select Address 2	A	Data	A	P
MSB	LSB	MSB	LSB	MSB	LSB	MSB	LSB	MSB	LSB	MSB	LSB

(Note) If any data is transmitted as Select Address 2 next to data, it is recognized as data, not as Select Address 2.

(4) Slave address

MSB	A6	A5	A4	A3	A2	A1	A0	R/W	LSB
	1	0	0	0	0	0	0	0	

80H

(5) Select Address & Data

BD37522FS

Items	Select Address (hex)	Data								
		MSB	Data						LSB	
		D7	D6	D5	D4	D3	D2	D1	D0	
Initial setup 1	01	Advanced switch ON/OFF	0	Advanced switch time of Input Gain/Volume Tone/Fader/Loudness			0	0	Advanced switch time of Mute	
Initial setup 2	02	0	0	0	0	0	0	0	0	
Initial setup 3	03	0	0	0	1	0	0	0	1	
Input Selector	05	0	0	0	Input selector					
Input gain	06	Mute ON/OFF	0	0	Input Gain					
Volume gain	20	Volume / Attenuation								
Fader 1ch Front	28	Fader Attenuation								
Fader 2ch Front	29	Fader Attenuation								
Fader 1ch Rear	2A	Fader Attenuation								
Fader 2ch Rear	2B	Fader Attenuation								
Test mode 1	2C	1	1	1	1	1	1	1	1	
Bass setup	41	0	0	Bass fo		0	0	Bass Q		
Test mode 2	44	0	0	0	0	0	0	0	0	
Treble setup	47	0	0	Treble fo		0	0	0	Treble Q	
Bass gain	51	Bass Boost/Cut	0	0	Bass Gain					
Test mode 3	54	0	0	0	0	0	0	0	0	
Treble gain	57	Treble Boost/Cut	0	0	Treble Gain					
Loudness Gain	75	0	Loudness Hicut		Loudness Gain					
System Reset	FE	1	0	0	0	0	0	0	1	

 Advanced switch

Note

- In function changing of the hatching part, it works Advanced switch.
- Upon continuous data transfer, the Select Address is circulated by the automatic increment function, as shown below.

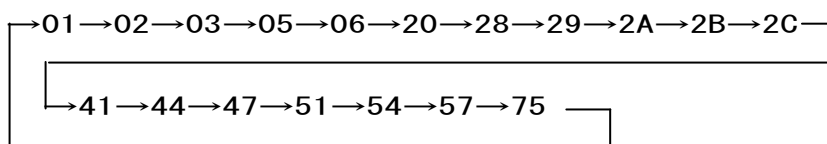

- For the function of input selector etc, it is not corresponded for advanced switch. Therefore, please apply mute on the side of a set when changes these setting.
- When using mute function of this IC at the time of changing input selector, please switch mute ON/OFF for waiting advanced-mute time.

BD37523FS

Items	Select Address (hex)	Data								
		MSB	Data						LSB	
		D7	D6	D5	D4	D3	D2	D1	D0	
Initial setup 1	01	Advanced switch ON/OFF	0	Advanced switch time of Input Gain/Volume Tone/Fader/Loudness			0	0	Advanced switch time of Mute	
Initial setup 2	02	LPF Phase	0	0	0	0	Subwoofer LPF fc			
Initial setup 3	03	0	0	0	1	0	0	0	1	
Input Selector	05	0	0	0	Input selector					
Input gain	06	Mute ON/OFF	0	0	Input Gain					
Volume gain	20	Volume Gain / Attenuation								
Fader 1ch Front	28	Fader Gain / Attenuation								
Fader 2ch Front	29	Fader Gain / Attenuation								
Fader 1ch Rear	2A	Fader Gain / Attenuation								
Fader 2ch Rear	2B	Fader Gain / Attenuation								
Fader Subwoofer	2C	Fader Gain / Attenuation								
Bass setup	41	0	0	Bass fo		0	0	Bass Q		
Test mode 1	44	0	0	0	0	0	0	0	0	
Treble setup	47	0	0	Treble fo		0	0	0	Treble Q	
Bass gain	51	Bass Boost/Cut	0	0	Bass Gain					
Test mode 2	54	0	0	0	0	0	0	0	0	
Treble gain	57	Treble Boost/Cut	0	0	Treble Gain					
Loudness Gain	75	0	Loudness Hicut		Loudness Gain					
System Reset	FE	1	0	0	0	0	0	0	1	

 Advanced switch

Note

1. In function changing of the hatching part, it works Advanced switch.
2. Upon continuous data transfer, the Select Address is circulated by the automatic increment function, as shown below.

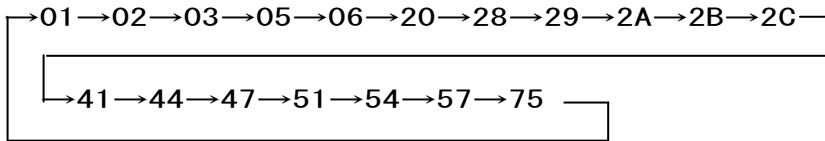

3. For the function of input selector etc, it is not corresponded for advanced switch. Therefore, please apply mute on the side of a set when changes these setting.
4. When using mute function of this IC at the time of changing input selector, please switch mute ON/OFF for waiting advanced-mute time.

Select address 01 (hex)

Time	Advanced switch time of Mute							LSB	
	MSB	D7	D6	D5	D4	D3	D2	D1	D0
0.6msec	Advanced Switch ON/OFF	0	Advanced switch time of Input gain/Volume Tone/Fader/Loudness	0	0	0	0	0	0
1.0msec								0	1
1.4msec								1	0
3.2msec								1	1

Time	Advanced switch time of Input gain/Volume/Tone/Fader/Loudness							LSB	
	MSB	D7	D6	D5	D4	D3	D2	D1	D0
4.7 msec	Advanced Switch ON/OFF	0	Advanced switch Time of Mute	0	0	0	0	0	0
7.1 msec				0	1				
11.2 msec				1	0				
14.4 msec				1	1				

Mode	Advanced switch ON/OFF							LSB	
	MSB	D7	D6	D5	D4	D3	D2	D1	D0
OFF	Advanced switch time of Input gain/Volume Tone/Fader/Loudness	0	0	Advanced switch Time of Mute	0	0	0	0	0
ON		1							

Select address 02 (hex)

fc	Subwoofer LPF fc							LSB	
	MSB	D7	D6	D5	D4	D3	D2	D1	D0
OFF	LPF Phase	0	0	0	0	0	0	0	0
55Hz							0	0	1
85Hz							0	1	0
120Hz							0	1	1
160Hz							1	0	0
Prohibition							Other setting		

(Available only BD37523FS)

Phase	LPF Phase							LSB	
	MSB	D7	D6	D5	D4	D3	D2	D1	D0
0°	Subwoofer LPF fc	0	0	0	0	0	0	0	0
180°		1							

(Available only BD37523FS)

Select address 05 (hex)

Mode	OUT F1/R1	OUT F2/R2	Input Selector							LSB	
			MSB	D7	D6	D5	D4	D3	D2	D1	D0
A	A1	A2	0	0	0	0	0	0	0	1	
B	B1	B2					0	0	1	0	
C diff	CP1	CP2					0	1	1	0	
D	D1	D2					1	0	1	0	
E	E1	E2					1	0	1	1	
Input SHORT							1	0	0	1	
Prohibition				Other setting							

Input SHORT : The input impedance of each input terminal is lowered from 100kΩ (TYP) to 6 kΩ (TYP).
(For quick charge of coupling capacitor)

 : Initial condition

Select address 06 (hex)

Gain	MSB			Input Gain				LSB
	D7	D6	D5	D4	D3	D2	D1	D0
0dB	Mute ON/OFF	0	0	0	0	0	0	0
1dB				0	0	0	0	1
2dB				0	0	0	1	0
3dB				0	0	0	1	1
4dB				0	0	1	0	0
5dB				0	0	1	0	1
6dB				0	0	1	1	0
7dB				0	0	1	1	1
8dB				0	1	0	0	0
9dB				0	1	0	0	1
10dB				0	1	0	1	0
11dB				0	1	0	1	1
12dB				0	1	1	0	0
13dB				0	1	1	0	1
14dB				0	1	1	1	0
15dB				0	1	1	1	1
16dB				1	0	0	0	0
17dB				1	0	0	0	1
18dB				1	0	0	1	0
19dB				1	0	0	1	1
20dB	1	0	1	0	0			
Prohibition	1	1	0	1	1			
	:	:	:	:	:			
	1	1	1	1	1			

Mode	MSB			Mute ON/OFF			LSB	
	D7	D6	D5	D4	D3	D2	D1	D0
OFF	0	0	0	Input Gain				
ON	1							

Select address 20, 28, 29, 2A, 2B, 2C (hex)

Gain & ATT	MSB							Vol., Fader Gain / Attenuation		LSB
	D7	D6	D5	D4	D3	D2	D1	D0		
Prohibition	0	0	0	0	0	0	0	0		
	0	0	0	0	0	0	0	1		
	:	:	:	:	:	:	:	:		
	0	1	1	1	0	0	0	0		
15dB	0	1	1	1	0	0	0	1		
14dB	0	1	1	1	0	0	1	0		
13dB	0	1	1	1	0	0	1	1		
:	:	:	:	:	:	:	:	:		
-77dB	1	1	0	0	1	1	0	1		
-78dB	1	1	0	0	1	1	1	0		
-79dB	1	1	0	0	1	1	1	1		
Prohibition	1	1	0	1	0	0	0	0		
	:	:	:	:	:	:	:	:		
	1	1	1	1	1	1	1	0		
-∞dB	1	1	1	1	1	1	1	1		

(About BD37522FS, only 0dB~∞dB are available at address 28, 29, 2A, 2B)

 : Initial condition

Select address 41 (hex)

Q factor	MSB		Bass Q factor				LSB	
	D7	D6	D5	D4	D3	D2	D1	D0
0.5	0	0	Bass fo		0	0	0	0
1.0							0	1
1.5							1	0
2.0							1	1

fo	MSB		Bass fo				LSB	
	D7	D6	D5	D4	D3	D2	D1	D0
60Hz	0	0	0	0	0	0	Bass Q factor	
80Hz			0	1				
100Hz			1	0				
120Hz			1	1				

Select address 47 (hex)

Q factor	MSB		Treble Q factor				LSB	
	D7	D6	D5	D4	D3	D2	D1	D0
0.75	0	0	Treble fo		0	0	0	0
1.25								1

fo	MSB		Treble fo				LSB	
	D7	D6	D5	D4	D3	D2	D1	D0
7.5kHz	0	0	0	0	0	0	0	Treble Q factor
10kHz			0	1				
12.5kHz			1	0				
15kHz			1	1				

 : Initial condition

Select address 51, 57 (hex)

Gain	MSB		Bass/ Treble Gain					LSB	
	D7	D6	D5	D4	D3	D2	D1	D0	
0dB	Bass/ Treble Boost /cut	0	0	0	0	0	0	0	
1dB				0	0	0	0	1	
2dB				0	0	0	1	0	
3dB				0	0	0	1	1	
4dB				0	0	1	0	0	
5dB				0	0	1	0	1	
6dB				0	0	1	1	0	
7dB				0	0	1	1	1	
8dB				0	1	0	0	0	
9dB				0	1	0	0	1	
10dB				0	1	0	1	0	
11dB				0	1	0	1	1	
12dB				0	1	1	0	0	
13dB				0	1	1	0	1	
14dB				0	1	1	1	0	
15dB				0	1	1	1	1	
16dB				1	0	0	0	0	
17dB				1	0	0	0	1	
18dB				1	0	0	1	0	
19dB				1	0	0	1	1	
20dB	1	0	1	0	0				
Prohibition	1	0	1	0	1				
	:	:	:	:	:				
	1	1	1	1	0				
				1	1	1	1	1	

Mode	MSB		Bass/ Treble Boost/Cut					LSB	
	D7	D6	D5	D4	D3	D2	D1	D0	
Boost	0	0	0	Bass/Treble Gain					
Cut	1								

 : Initial condition

Select address 75 (hex)

Mode	Loudness Hicut									
	MSB	D7	D6	D5	D4	D3	D2	D1	LSB	D0
Hicut1	0		0	0	Loudness Gain					
Hicut2			0	1						
Hicut3			1	0						
Hicut4			1	1						

Gain	Loudness Gain									
	MSB	D7	D6	D5	D4	D3	D2	D1	LSB	D0
0dB	0	Loudness Hicut			0	0	0	0	0	0
1dB						0	0	0	0	1
2dB						0	0	0	1	0
3dB						0	0	0	1	1
4dB						0	0	1	0	0
5dB						0	0	1	0	1
6dB						0	0	1	1	0
7dB						0	0	1	1	1
8dB						0	1	0	0	0
9dB						0	1	0	0	1
10dB						0	1	0	1	0
11dB						0	1	0	1	1
12dB						0	1	1	0	0
13dB						0	1	1	0	1
14dB						0	1	1	1	0
15dB						0	1	1	1	1
16dB						1	0	0	0	0
17dB						1	0	0	0	1
18dB						1	0	0	1	0
19dB						1	0	0	1	1
20dB				1	0	1	0	0		
Prohibition				1	0	1	0	1		
				:	:	:	:	:		
				1	1	1	1	1		

 : Initial condition

(6) About power on reset

At on of supply voltage circuit made initialization inside IC is built-in. Please send data to all address as initial data at supply voltage on. And please supply mute at set side until this initial data is sent.

Item	Symbol	Limit			Unit	Condition
		Min.	Typ.	Max.		
Rise time of VCC	Trise	33	—	—	usec	VCC rise time from 0V to 5V
VCC voltage of release power on reset	Vpor	—	4.1	—	V	

(7) About external compulsory mute terminal

Mute is possible forcibly than the outside after input again department, by the setting of the MUTE terminal.

Mute Voltage Condition	Mode
GND~1.0V	MUTE ON
2.3V~VCC	MUTE OFF

Establish the voltage of MUTE in the condition to have been defined.

Volume / Fader volume attenuation of the details

(dB)	D7	D6	D5	D4	D3	D2	D1	D0	(dB)	D7	D6	D5	D4	D3	D2	D1	D0
+15	0	1	1	1	0	0	0	1	-33	1	0	1	0	0	0	0	1
+14	0	1	1	1	0	0	1	0	-34	1	0	1	0	0	0	1	0
+13	0	1	1	1	0	0	1	1	-35	1	0	1	0	0	0	1	1
+12	0	1	1	1	0	1	0	0	-36	1	0	1	0	0	1	0	0
+11	0	1	1	1	0	1	0	1	-37	1	0	1	0	0	1	0	1
+10	0	1	1	1	0	1	1	0	-38	1	0	1	0	0	1	1	0
+9	0	1	1	1	0	1	1	1	-39	1	0	1	0	0	1	1	1
+8	0	1	1	1	1	0	0	0	-40	1	0	1	0	1	0	0	0
+7	0	1	1	1	1	0	0	1	-41	1	0	1	0	1	0	0	1
+6	0	1	1	1	1	0	1	0	-42	1	0	1	0	1	0	1	0
+5	0	1	1	1	1	0	1	1	-43	1	0	1	0	1	0	1	1
+4	0	1	1	1	1	1	0	0	-44	1	0	1	0	1	1	0	0
+3	0	1	1	1	1	1	0	1	-45	1	0	1	0	1	1	0	1
+2	0	1	1	1	1	1	1	0	-46	1	0	1	0	1	1	1	0
+1	0	1	1	1	1	1	1	1	-47	1	0	1	0	1	1	1	1
0	1	0	0	0	0	0	0	0	-48	1	0	1	1	0	0	0	0
-1	1	0	0	0	0	0	0	1	-49	1	0	1	1	0	0	0	1
-2	1	0	0	0	0	0	1	0	-50	1	0	1	1	0	0	1	0
-3	1	0	0	0	0	0	1	1	-51	1	0	1	1	0	0	1	1
-4	1	0	0	0	0	1	0	0	-52	1	0	1	1	0	1	0	0
-5	1	0	0	0	0	1	0	1	-53	1	0	1	1	0	1	0	1
-6	1	0	0	0	0	1	1	0	-54	1	0	1	1	0	1	1	0
-7	1	0	0	0	0	1	1	1	-55	1	0	1	1	0	1	1	1
-8	1	0	0	0	1	0	0	0	-56	1	0	1	1	1	0	0	0
-9	1	0	0	0	1	0	0	1	-57	1	0	1	1	1	0	0	1
-10	1	0	0	0	1	0	1	0	-58	1	0	1	1	1	0	1	0
-11	1	0	0	0	1	0	1	1	-59	1	0	1	1	1	0	1	1
-12	1	0	0	0	1	1	0	0	-60	1	0	1	1	1	1	0	0
-13	1	0	0	0	1	1	0	1	-61	1	0	1	1	1	1	0	1
-14	1	0	0	0	1	1	1	0	-62	1	0	1	1	1	1	1	0
-15	1	0	0	0	1	1	1	1	-63	1	0	1	1	1	1	1	1
-16	1	0	0	1	0	0	0	0	-64	1	1	0	0	0	0	0	0
-17	1	0	0	1	0	0	0	1	-65	1	1	0	0	0	0	0	1
-18	1	0	0	1	0	0	1	0	-66	1	1	0	0	0	0	1	0
-19	1	0	0	1	0	0	1	1	-67	1	1	0	0	0	0	1	1
-20	1	0	0	1	0	1	0	0	-68	1	1	0	0	0	1	0	0
-21	1	0	0	1	0	1	0	1	-69	1	1	0	0	0	1	0	1
-22	1	0	0	1	0	1	1	0	-70	1	1	0	0	0	1	1	0
-23	1	0	0	1	0	1	1	1	-71	1	1	0	0	0	1	1	1
-24	1	0	0	1	1	0	0	0	-72	1	1	0	0	1	0	0	0
-25	1	0	0	1	1	0	0	1	-73	1	1	0	0	1	0	0	1
-26	1	0	0	1	1	0	1	0	-74	1	1	0	0	1	0	1	0
-27	1	0	0	1	1	0	1	1	-75	1	1	0	0	1	0	1	1
-28	1	0	0	1	1	1	0	0	-76	1	1	0	0	1	1	0	0
-29	1	0	0	1	1	1	0	1	-77	1	1	0	0	1	1	0	1
-30	1	0	0	1	1	1	1	0	-78	1	1	0	0	1	1	1	0
-31	1	0	0	1	1	1	1	1	-79	1	1	0	0	1	1	1	1
-32	1	0	1	0	0	0	0	0	-∞	1	1	1	1	1	1	1	1

About BD37522FS, Fader Volume only 0dB~∞dB are available.

 : Initial condition

● Application circuit

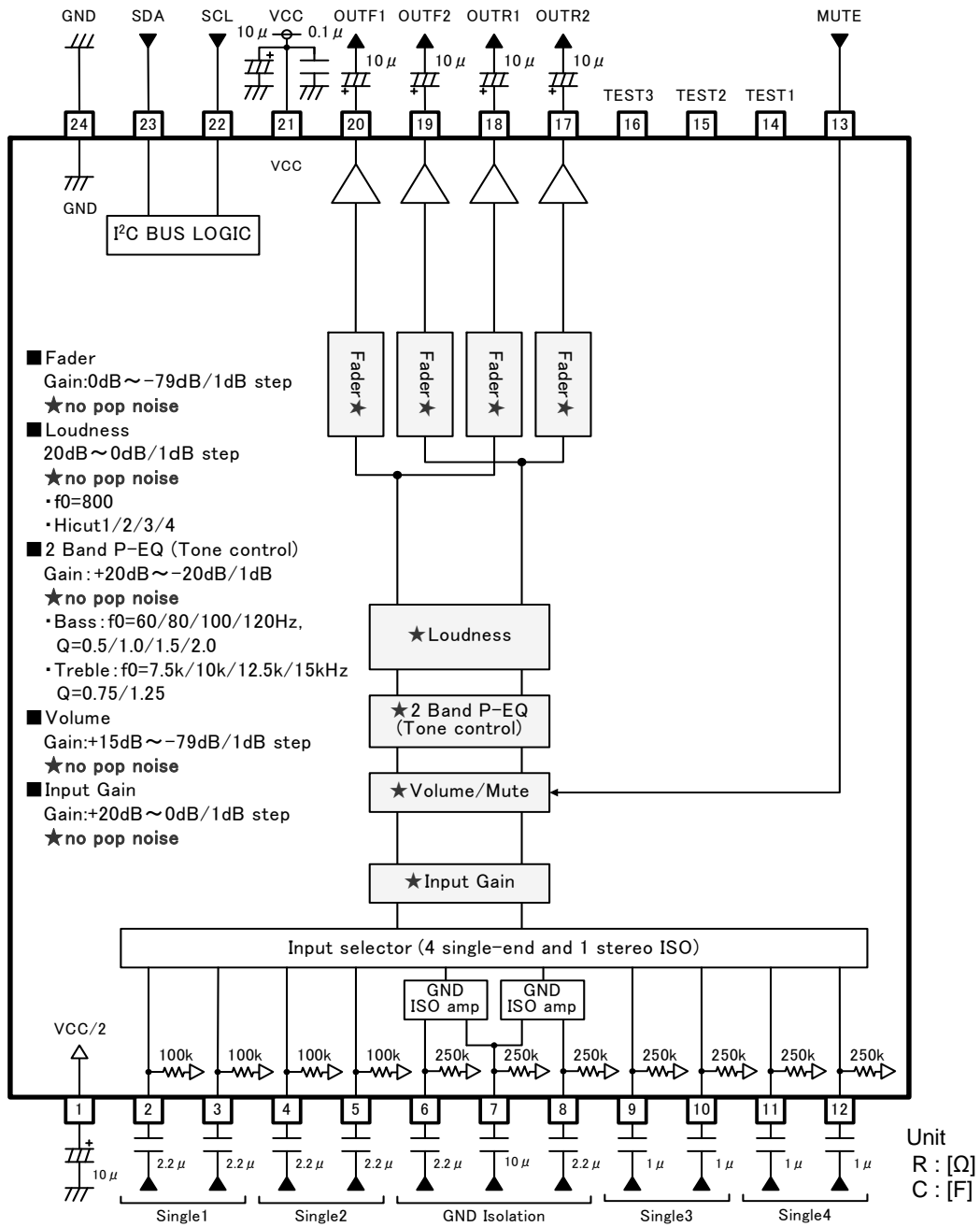

Fig. 21 BD37522FS

Notes on wiring

- ① Please connect the decoupling capacitor of a power supply in the shortest distance as much as possible to GND.
- ② Lines of GND shall be one-point connected.
- ③ Wiring pattern of Digital shall be away from that of analog unit and cross-talk shall not be acceptable.
- ④ I²C Lines of SCL and SDA shall not be parallel if possible. The lines shall be shielded, if they are adjacent to each other.
- ⑤ Lines of analog input shall not be parallel if possible. The lines shall be shielded, if they are adjacent to each other.
- ⑥ About TEST pin (14, 15, 16pin), please use with OPEN.

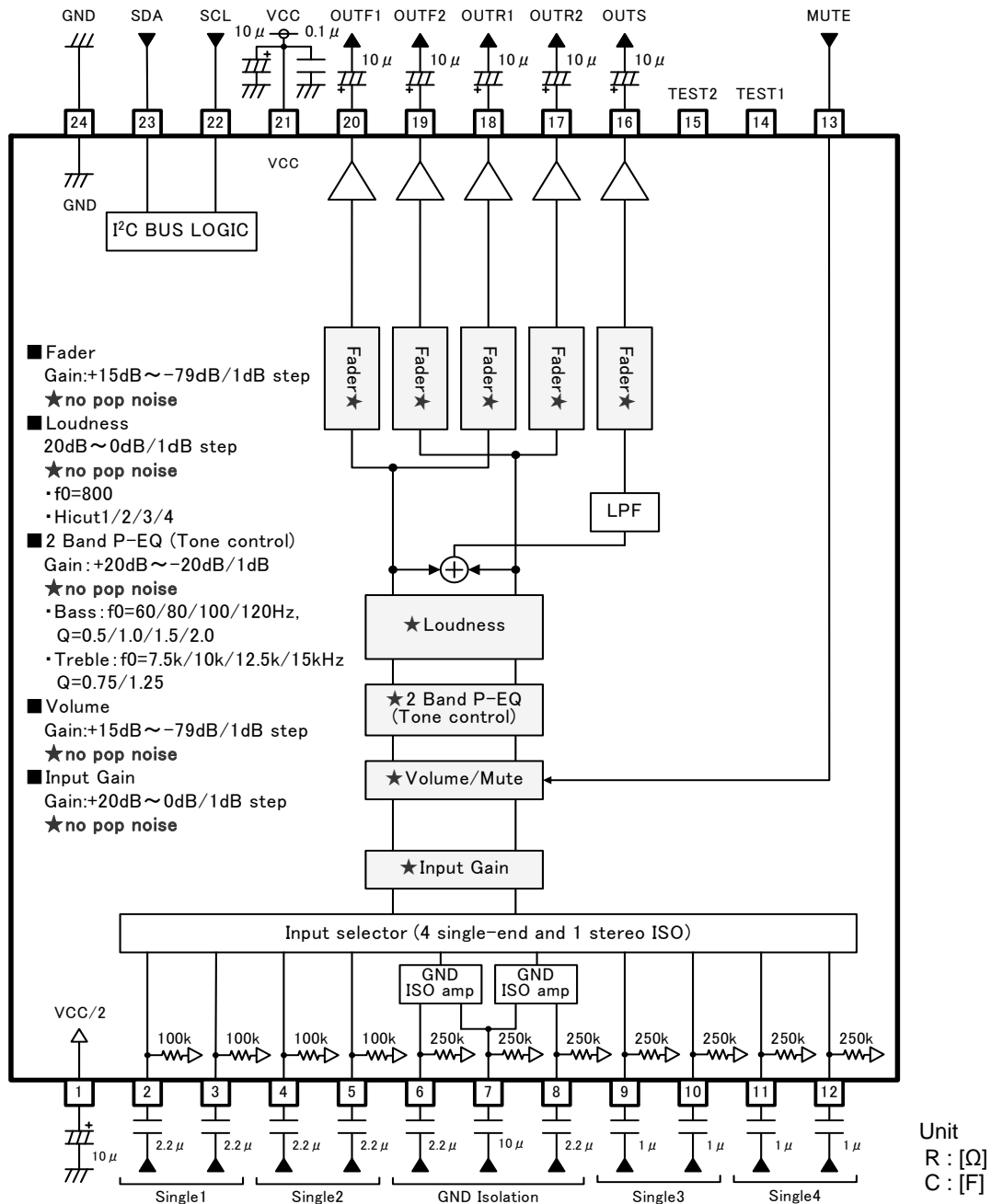

Fig. 22 BD37523FS

Notes on wiring

- ① Please connect the decoupling capacitor of a power supply in the shortest distance as much as possible to GND.
- ② Lines of GND shall be one-point connected.
- ③ Wiring pattern of Digital shall be away from that of analog unit and cross-talk shall not be acceptable.
- ④ Lines of SCL and SDA of I²C BUS shall not be parallel if possible. The lines shall be shielded, if they are adjacent to each other.
- ⑤ Lines of analog input shall not be parallel if possible. The lines shall be shielded, if they are adjacent to each other.
- ⑥ About TEST pin(14, 15, 16pin), please use with OPEN.

● Interfaces

Terminal No.	Terminal Name	Terminal Voltage	Equivalent Circuit	Terminal Description
2 3 4 5	A1 A2 B1 B2	4.25		A terminal for signal input. The input impedance is 100kΩ (typ).
6 7 8 9 10 11 12	CP1 CN CP2 D1 D2 E1 E2	4.25		A terminal for signal input. The input impedance is 250kΩ (typ).
13	MUTE	—		A terminal for external compulsory mute. If terminal voltage is High level, the mute is off. And if the terminal voltage is Low level, the mute is on.
16 17 18 19 20	OUTS OUTR2 OUTR1 OUTF2 OUTF1	4.25		A terminal for fader and Subwoofer output. (16pin:OUTS is only in BD37523FS,)

The figure in the pin explanation and input/output equivalent circuit is reference value, it doesn't guarantee the value.

Terminal No.	Terminal Name	Terminal Voltage	Equivalent Circuit	Terminal Description
21	VCC	8.5		Power supply terminal.
22	SCL	-		A terminal for clock input of I ² C BUS communication.
23	SDA	-		A terminal for data input of I ² C BUS communication.
24	GND	0		Ground terminal.
1	FIL	4.25		Voltage for reference bias of analog signal system. The simple precharge circuit and simple discharge circuit for an external capacitor are built in.
14 15 16	TEST	-		TEST terminal About BD37522FS, 14, 15, 16pin are TEST Pin. About BD37523FS, 14, 15pin are TEST Pin.

The figure in the pin explanation and input/output equivalent circuit is reference value, it doesn't guarantee the value.

●Notes for use

1. Absolute maximum rating voltage

When it impressed the voltage on VCC more than the absolute maximum rating voltage, circuit currents increase rapidly, and there is absolutely a case to reach characteristic deterioration and destruction of a device. In particular in a surge examination of a set, when it is expected the impressing surge at VCC terminal (21pin), please do not impress the large and over the absolute maximum rating voltage (including a operating voltage + surge ingredient (around 14V)).

2. About a signal input part

1) About constant set up of input coupling capacitor

In the signal input terminal, the constant setting of input coupling capacitor C(F) be sufficient input impedance $R_{IN}(\Omega)$ inside IC and please decide. The first HPF characteristic of RC is composed.

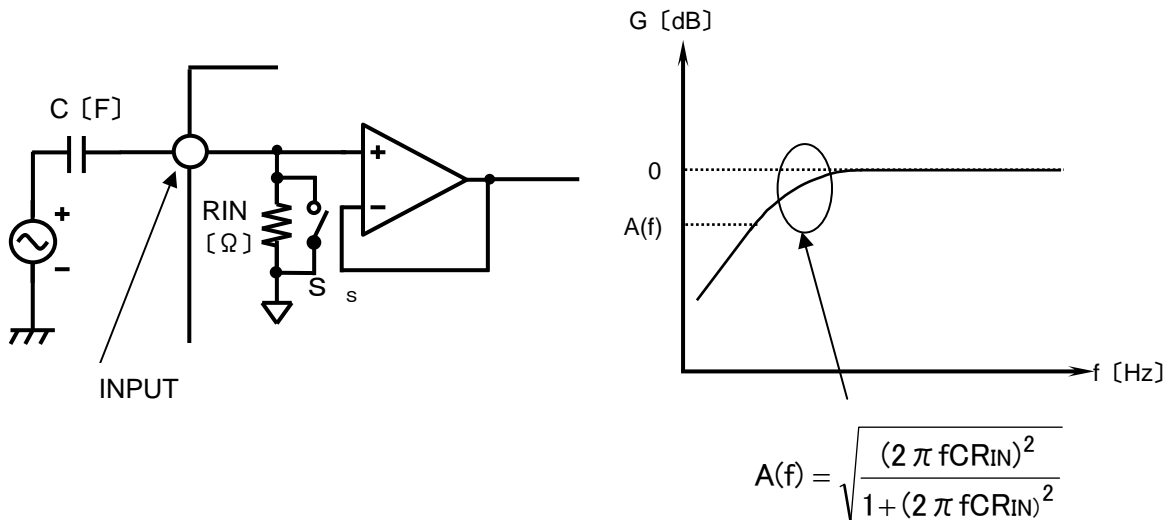

2) About the input selector SHORT

SHORT mode is the command which makes switch $S_{SH} = ON$ an input selector part and input impedance R_{IN} of all terminals, and makes resistance small. Switch S_{SH} is OFF when not choosing a SHORT command.

A constant time becomes small at the time of this command twisting to the resistance inside the capacitor connected outside and LSI. The charge time of a capacitor becomes short. Since SHORT mode turns ON the switch of S_{SH} and makes it low impedance, please use it at the time of a non-signal.

3. About Mute terminal (13pin) when power supply is off

Any voltage shall not be supplied to Mute terminal (13pin) when power-supply is off.

Please insert a resistor (about 2.2k Ω) to Mute terminal in series, if voltage is supplied to mute terminal in case. (Please refer Application Circuit Diagram.)

4. About TEST Pin

About TEST Pin, please use with OPEN.

About BD37522FS, 14, 15, 16pin are TEST Pin. About BD37523FS, 14, 15pin are TEST Pin.

●Thermal Derating Curve

About the thermal design by the IC

Characteristics of an IC have a great deal to do with the temperature at which it is used, and exceeding absolute maximum ratings may degrade and destroy elements. Careful consideration must be given to the heat of the IC from the two standpoints of immediate damage and long-term reliability of operation.

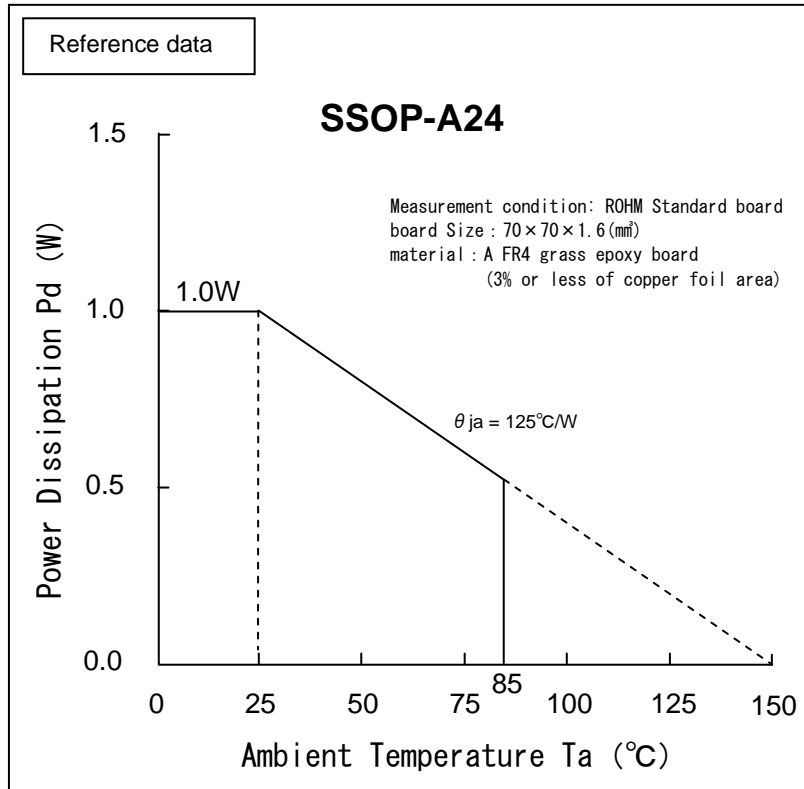

Fig.23 Temperature Derating Curve

Note) Values are actual measurements and are not guaranteed.

Power dissipation values vary according to the board on which the IC is mounted.

● Ordering part number

B	D
---	---

Part No.

3	7	5	2	2
---	---	---	---	---

Part No.
37522
37523

F	S	-	E	2
---	---	---	---	---

Package
FS : SSOP-A24

Packaging and forming specification
E2: Embossed tape and reel

SSOP-A24

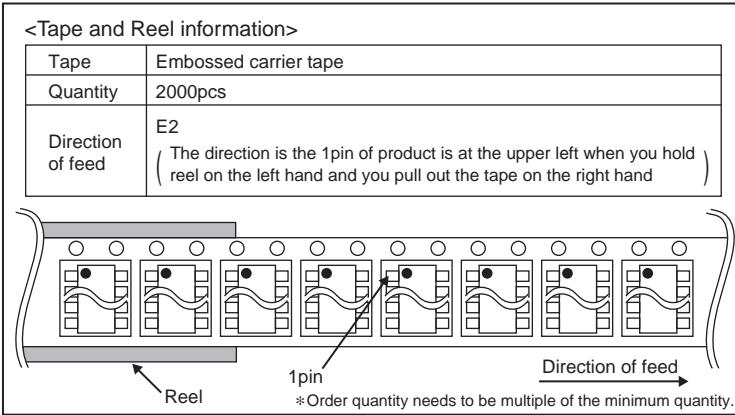
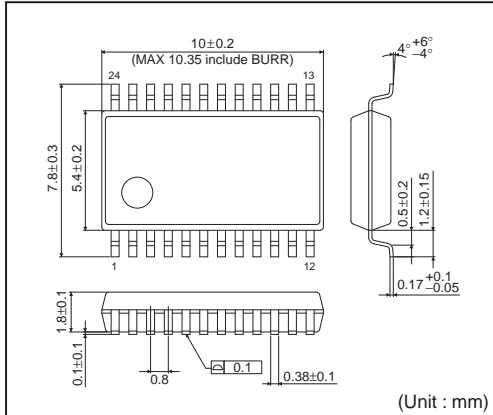

Notice

Precaution on using ROHM Products

- Our Products are designed and manufactured for application in ordinary electronic equipments (such as AV equipment, OA equipment, telecommunication equipment, home electronic appliances, amusement equipment, etc.). If you intend to use our Products in devices requiring extremely high reliability (such as medical equipment ^(Note 1), transport equipment, traffic equipment, aircraft/spacecraft, nuclear power controllers, fuel controllers, car equipment including car accessories, safety devices, etc.) and whose malfunction or failure may cause loss of human life, bodily injury or serious damage to property ("Specific Applications"), please consult with the ROHM sales representative in advance. Unless otherwise agreed in writing by ROHM in advance, ROHM shall not be in any way responsible or liable for any damages, expenses or losses incurred by you or third parties arising from the use of any ROHM's Products for Specific Applications.

(Note1) Medical Equipment Classification of the Specific Applications

JAPAN	USA	EU	CHINA
CLASS III	CLASS III	CLASS II b	CLASS III
CLASS IV		CLASS III	

- ROHM designs and manufactures its Products subject to strict quality control system. However, semiconductor products can fail or malfunction at a certain rate. Please be sure to implement, at your own responsibilities, adequate safety measures including but not limited to fail-safe design against the physical injury, damage to any property, which a failure or malfunction of our Products may cause. The following are examples of safety measures:
 - Installation of protection circuits or other protective devices to improve system safety
 - Installation of redundant circuits to reduce the impact of single or multiple circuit failure
- Our Products are designed and manufactured for use under standard conditions and not under any special or extraordinary environments or conditions, as exemplified below. Accordingly, ROHM shall not be in any way responsible or liable for any damages, expenses or losses arising from the use of any ROHM's Products under any special or extraordinary environments or conditions. If you intend to use our Products under any special or extraordinary environments or conditions (as exemplified below), your independent verification and confirmation of product performance, reliability, etc. prior to use, must be necessary:
 - Use of our Products in any types of liquid, including water, oils, chemicals, and organic solvents
 - Use of our Products outdoors or in places where the Products are exposed to direct sunlight or dust
 - Use of our Products in places where the Products are exposed to sea wind or corrosive gases, including Cl₂, H₂S, NH₃, SO₂, and NO₂
 - Use of our Products in places where the Products are exposed to static electricity or electromagnetic waves
 - Use of our Products in proximity to heat-producing components, plastic cords, or other flammable items
 - Sealing or coating our Products with resin or other coating materials
 - Use of our Products without cleaning residue of flux (even if you use no-clean type fluxes, cleaning residue of flux is recommended); or Washing our Products by using water or water-soluble cleaning agents for cleaning residue after soldering
 - Use of the Products in places subject to dew condensation
- The Products are not subject to radiation-proof design.
- Please verify and confirm characteristics of the final or mounted products in using the Products.
- In particular, if a transient load (a large amount of load applied in a short period of time, such as pulse. is applied, confirmation of performance characteristics after on-board mounting is strongly recommended. Avoid applying power exceeding normal rated power; exceeding the power rating under steady-state loading condition may negatively affect product performance and reliability.
- De-rate Power Dissipation (Pd) depending on Ambient temperature (Ta). When used in sealed area, confirm the actual ambient temperature.
- Confirm that operation temperature is within the specified range described in the product specification.
- ROHM shall not be in any way responsible or liable for failure induced under deviant condition from what is defined in this document.

Precaution for Mounting / Circuit board design

- When a highly active halogenous (chlorine, bromine, etc.) flux is used, the residue of flux may negatively affect product performance and reliability.
- In principle, the reflow soldering method must be used; if flow soldering method is preferred, please consult with the ROHM representative in advance.

For details, please refer to ROHM Mounting specification

Precautions Regarding Application Examples and External Circuits

1. If change is made to the constant of an external circuit, please allow a sufficient margin considering variations of the characteristics of the Products and external components, including transient characteristics, as well as static characteristics.
2. You agree that application notes, reference designs, and associated data and information contained in this document are presented only as guidance for Products use. Therefore, in case you use such information, you are solely responsible for it and you must exercise your own independent verification and judgment in the use of such information contained in this document. ROHM shall not be in any way responsible or liable for any damages, expenses or losses incurred by you or third parties arising from the use of such information.

Precaution for Electrostatic

This Product is electrostatic sensitive product, which may be damaged due to electrostatic discharge. Please take proper caution in your manufacturing process and storage so that voltage exceeding the Products maximum rating will not be applied to Products. Please take special care under dry condition (e.g. Grounding of human body / equipment / solder iron, isolation from charged objects, setting of Ionizer, friction prevention and temperature / humidity control).

Precaution for Storage / Transportation

1. Product performance and soldered connections may deteriorate if the Products are stored in the places where:
 - [a] the Products are exposed to sea winds or corrosive gases, including Cl₂, H₂S, NH₃, SO₂, and NO₂
 - [b] the temperature or humidity exceeds those recommended by ROHM
 - [c] the Products are exposed to direct sunshine or condensation
 - [d] the Products are exposed to high Electrostatic
2. Even under ROHM recommended storage condition, solderability of products out of recommended storage time period may be degraded. It is strongly recommended to confirm solderability before using Products of which storage time is exceeding the recommended storage time period.
3. Store / transport cartons in the correct direction, which is indicated on a carton with a symbol. Otherwise bent leads may occur due to excessive stress applied when dropping of a carton.
4. Use Products within the specified time after opening a humidity barrier bag. Baking is required before using Products of which storage time is exceeding the recommended storage time period.

Precaution for Product Label

QR code printed on ROHM Products label is for ROHM's internal use only.

Precaution for Disposition

When disposing Products please dispose them properly using an authorized industry waste company.

Precaution for Foreign Exchange and Foreign Trade act

Since our Products might fall under controlled goods prescribed by the applicable foreign exchange and foreign trade act, please consult with ROHM representative in case of export.

Precaution Regarding Intellectual Property Rights

1. All information and data including but not limited to application example contained in this document is for reference only. ROHM does not warrant that foregoing information or data will not infringe any intellectual property rights or any other rights of any third party regarding such information or data. ROHM shall not be in any way responsible or liable for infringement of any intellectual property rights or other damages arising from use of such information or data.:
2. No license, expressly or implied, is granted hereby under any intellectual property rights or other rights of ROHM or any third parties with respect to the information contained in this document.

Other Precaution

1. This document may not be reprinted or reproduced, in whole or in part, without prior written consent of ROHM.
2. The Products may not be disassembled, converted, modified, reproduced or otherwise changed without prior written consent of ROHM.
3. In no event shall you use in any way whatsoever the Products and the related technical information contained in the Products or this document for any military purposes, including but not limited to, the development of mass-destruction weapons.
4. The proper names of companies or products described in this document are trademarks or registered trademarks of ROHM, its affiliated companies or third parties.

General Precaution

1. Before you use our Products, you are requested to carefully read this document and fully understand its contents. ROHM shall not be in any way responsible or liable for failure, malfunction or accident arising from the use of any ROHM's Products against warning, caution or note contained in this document.
2. All information contained in this document is current as of the issuing date and subject to change without any prior notice. Before purchasing or using ROHM's Products, please confirm the latest information with a ROHM sales representative.
3. The information contained in this document is provided on an "as is" basis and ROHM does not warrant that all information contained in this document is accurate and/or error-free. ROHM shall not be in any way responsible or liable for any damages, expenses or losses incurred by you or third parties resulting from inaccuracy or errors of or concerning such information.



Компания «ЭлектроПласт» предлагает заключение долгосрочных отношений при поставках импортных электронных компонентов на взаимовыгодных условиях!

Наши преимущества:

- Оперативные поставки широкого спектра электронных компонентов отечественного и импортного производства напрямую от производителей и с крупнейших мировых складов;
- Поставка более 17-ти миллионов наименований электронных компонентов;
- Поставка сложных, дефицитных, либо снятых с производства позиций;
- Оперативные сроки поставки под заказ (от 5 рабочих дней);
- Экспресс доставка в любую точку России;
- Техническая поддержка проекта, помощь в подборе аналогов, поставка прототипов;
- Система менеджмента качества сертифицирована по Международному стандарту ISO 9001;
- Лицензия ФСБ на осуществление работ с использованием сведений, составляющих государственную тайну;
- Поставка специализированных компонентов (Xilinx, Altera, Analog Devices, Intersil, Interpoint, Microsemi, Aeroflex, Peregrine, Syfer, Eurofarad, Texas Instrument, Miteq, Cobham, E2V, MA-COM, Hittite, Mini-Circuits, General Dynamics и др.);

Помимо этого, одним из направлений компании «ЭлектроПласт» является направление «Источники питания». Мы предлагаем Вам помощь Конструкторского отдела:

- Подбор оптимального решения, техническое обоснование при выборе компонента;
- Подбор аналогов;
- Консультации по применению компонента;
- Поставка образцов и прототипов;
- Техническая поддержка проекта;
- Защита от снятия компонента с производства.



Как с нами связаться

Телефон: 8 (812) 309 58 32 (многоканальный)

Факс: 8 (812) 320-02-42

Электронная почта: org@eplast1.ru

Адрес: 198099, г. Санкт-Петербург, ул. Калинина, дом 2, корпус 4, литера А.