



Micro Commercial Components



Micro Commercial Components
 20736 Marilla Street Chatsworth
 CA 91311
 Phone: (818) 701-4933
 Fax: (818) 701-4939

BZX84C2V4 THRU BZX84C(B)51

Silicon 350 mWatt Zener Diodes

Features

- Planar Die construction
- 350mW Power Dissipation
- Zener Voltages from 2.4V - 51V
- Ideally Suited for Automated Assembly Processes
- Halogen free available upon request by adding suffix "-HF"

Mechanical Data

- Epoxy meets UL 94 V-0 flammability rating
- Moisture Sensitivity Level 1
- Lead Free Finish/RoHS Compliant ("P" Suffix designates RoHS Compliant. See ordering information)
- Weight: 0.008 grams (approx.)

Maximum Ratings @ 25°C Unless Otherwise Specified

Maximum Forward Voltage@IF=10mA	V _F	0.9	V
Power Dissipation (Note A)	P _(AV)	350	mWatt
Operation And Storage Temperature	T _J , T _{STG}	-55°C to +150°C	
Peak Forward Surge Current (Note B)	I _{FSM}	2.0	A
Thermal Resistance (Note C)	R _{thja}	357	°C/W

NOTES:

- A. Mounted on 5.0mm² (.013mm thick) land areas.
 B. Measured on 8.3ms, single half sine-wave or equivalent square wave, duty cycle = 4 pulses per minute maximum.
 C. Valid provided the terminals are kept at ambient temperature

*Pin Configuration - Top View



SOT-23

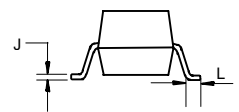
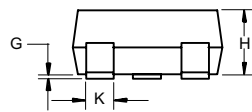
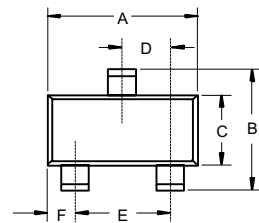

DIM	INCHES		MM		NOTE
	MIN	MAX	MIN	MAX	
A	.110	.120	2.80	3.04	
B	.083	.104	2.10	2.64	
C	.047	.055	1.20	1.40	
D	.035	.041	.89	1.03	
E	.070	.081	1.78	2.05	
F	.018	.024	.45	.60	
G	.0005	.0039	.013	.100	
H	.035	.044	.89	1.12	
J	.003	.007	.085	.180	
K	.015	.020	.37	.51	
L	.007	.020	.20	.50	

Suggested Solder Pad Layout

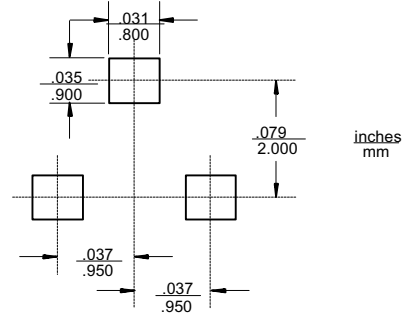

BZX84C2V4 thru BZX84C51

ELECTRICAL CHARACTERISTICS (Ta=25°C unless otherwise noted)

Part Number	Marking	Nominal Zener Voltage			Max. Zener Impedance				Max.Reverse Leakage Current	
		Vz(V) @ I _{ZT}			Z _{ZT} @ I _{ZT}		Z _{ZK} @ I _{ZK}		IR @ VR	
		Nom.	Min.	Max.	Ohm	mA	Ohm	mA	µA	V
BZX84C2V4	W1/Z11	2.4	2.28	2.52	100	5	600	1	50	1.0
BZX84C2V7	W2/Z12	2.7	2.5	2.9	100	5	600	1	20	1.0
BZX84C3V0	W3/Z13	3	2.8	3.2	95	5	600	1	10	1.0
BZX84C3V3	W4/Z14	3.3	3.1	3.5	95	5	600	1	5	1.0
BZX84C3V6	W5/Z15	3.6	3.4	3.8	90	5	600	1	5	1.0
BZX84C3V9	W6/Z16	3.9	3.7	4.1	90	5	600	1	3	1.0
BZX84C4V3	W7/Z17	4.3	4	4.6	90	5	600	1	3	1.0
BZX84C4V7	W8/Z1	4.7	4.4	5	80	5	500	1	3	2.0
BZX84C5V1	W9/Z2	5.1	4.8	5.4	60	5	480	1	2	2.0
BZX84C5V6	WA/Z3	5.6	5.2	6	40	5	400	1	1	2.0
BZX84C6V2	WB/Z4	6.2	5.8	6.6	10	5	150	1	3	4.0
BZX84C6V8	WC/Z5	6.8	6.4	7.2	15	5	80	1	2	4.0
BZX84C7V5	WD/Z6	7.5	7	7.9	15	5	80	1	1	5.0
BZX84C8V2	WE/Z7	8.2	7.7	8.7	15	5	80	1	0.7	5.0
BZX84C9V1	WF/Z8	9.1	8.5	9.6	15	5	100	1	0.5	6.0
BZX84C10	WG/Z9	10	9.4	10.6	20	5	150	1	0.2	7.0
BZX84C11	WH/Y1	11	10.4	11.6	20	5	150	1	0.1	8.0
BZX84C12	WI/Y2	12	11.4	12.7	25	5	150	1	0.1	8.0
BZX84C13	WK/Y3	13	12.4	14.1	30	5	170	1	0.1	8.0
BZX84C15	WL/Y4	15	13.8	15.6	30	5	200	1	0.1	10.5
BZX84C16	WM /Y5	16	15.3	17.1	40	5	200	1	0.1	11.2
BZX84C18	WN/Y6	18	16.8	19.1	45	5	225	1	0.1	12.6
BZX84C20	WO/Y7	20	18.8	21.2	55	5	225	1	0.1	14.0
BZX84C22	WP/Y8	22	20.8	23.3	55	5	250	1	0.1	15.4
BZX84C24	WR/Y9	24	22.8	25.6	70	5	250	1	0.1	16.8
BZX84C27	WS/Y10	27	25.1	28.9	80	2	300	1	0.1	18.9
BZX84C30	WT /Y11	30	28	32	80	2	300	1	0.1	21.0
BZX84C33	WU/Y12	33	31	35	80	2	325	1	0.1	23.1
BZX84C36	WW/Y13	36	34	38	90	2	350	1	0.1	25.2
BZX84C39	WX/Y14	39	37	41	130	2	350	1	0.1	27.3
BZX84C43	WY	43	40.85	45.15	150	5	375	1	0.1	30.10
BZX84C47	WZ	47	44.65	49.35	170	5	375	1	0.1	32.90
BZX84C51	XA	51	48.45	53.55	100	5	400	1	0.1	35.70

NOTE:

- Standard zener voltage tolerance is +/- 5% with a 'C' suffix from BZX84C2V4-BZX84C51, suffix 'B' is +/- 2% tolerance from BZX84B4V3-BZX84B51.
- Zener Voltage (Vz) Measurement. Guarantees the zener voltage when measured at 90 seconds while maintaining the lead temperature (TL) AT 30 °C, from the diode body.
- Zener Impedance (Zz) Derivation. The zener impedance is derived from the 60 cycle ac voltage, which results when an AC current having an rms value equal to 10% of the dc zener current (Izt or Izk) is superimposed on Izt or Izk.
- Surge Current (IR) Non-Repetitive. The rating listed in the electrical characteristics table is maximum peak, non-repetitive, reverse surge current of 1/2 square wave or equivalent sine wave pulse of 1/120 second duration superimposed on the test current, Izt, per JEDEC registration; however, actual device capability is as described in Figure 5.

BZX84B4V3 thru BZX84B51

ELECTRICAL CHARACTERISTICS (Ta=25°C unless otherwise noted)

Part Number	Marking	Nominal Zener Voltage			Max. Zener Impedance				Max.Reverse Leakage Current	
		Vz(V) @ I _{ZT}			Z _{ZT} @ I _{ZT}		Z _{ZK} @ I _{ZK}		IR @ VR	
		Nom.	Min.	Max.	Ohm	mA	Ohm	mA	µA	V
BZX84B4V3	W7	4.3	4.21	4.39	90	5	600	1	3.0	1.0
BZX84B4V7	W8/Z1	4.7	4.61	4.79	80	5	500	1	3.0	2.0
BZX84B5V1	W9/Z2	5.1	5.00	5.20	60	5	480	1	2.0	2.0
BZX84B5V6	WA/Z3	5.6	5.49	5.71	40	5	400	1	1.0	2.0
BZX84B6V2	WB/Z4	6.2	6.08	6.32	10	5	150	1	3.0	4.0
BZX84B6V8	WC/Z5	6.8	6.66	6.94	15	5	80	1	2.0	4.0
BZX84B7V5	WD/Z6	7.5	7.35	7.65	15	5	80	1	1.0	5.0
BZX84B8V2	WE/Z7	8.2	8.04	8.36	15	5	80	1	0.7	5.0
BZX84B9V1	WF/Z8	9.1	8.92	9.28	15	5	100	1	0.5	6.0
BZX84B10	WG/Z9	10	9.80	10.20	20	5	150	1	0.2	7.0
BZX84B11	WH/Y1	11	10.78	11.22	20	5	150	1	0.1	8.0
BZX84B12	WI/Y2	12	11.76	12.24	25	5	150	1	0.1	8.0
BZX84B13	WK/Y3	13	12.74	13.26	30	5	170	1	0.1	8.0
BZX84B15	WL/Y4	15	14.70	15.30	30	5	200	1	0.1	10.5
BZX84B16	WM/Y5	16	15.68	16.32	40	5	200	1	0.1	11.2
BZX84B18	WN/Y6	18	17.64	18.36	45	5	225	1	0.1	12.6
BZX84B20	WO/Y7	20	19.60	20.40	55	5	225	1	0.1	14.0
BZX84B22	WP/Y8	22	21.56	22.44	55	5	250	1	0.1	15.4
BZX84B24	WR/Y9	24	23.52	24.48	70	5	250	1	0.1	16.8
BZX84B27	WS/Y10	27	26.46	27.54	80	5	300	1	0.1	18.9
BZX84B30	WT/Y11	30	29.40	30.60	80	5	300	1	0.1	21.0
BZX84B33	WU/Y12	33	32.34	33.66	80	5	325	1	0.1	23.1
BZX84B36	WW/Y13	36	35.28	36.72	90	5	350	1	0.1	25.2
BZX84B39	WX/Y14	39	38.22	39.78	130	5	350	1	0.1	27.3
BZX84B43	WY	43	42.14	43.86	150	5	375	1	0.1	30.1
BZX84B47	WZ	47	46.06	47.94	170	5	375	1	0.1	32.9
BZX84B51	XA	51	49.98	52.02	100	5	750	1	0.1	38.0

NOTE:

- Standard zener voltage tolerance is +/- 5% with a 'C' suffix from BZX84C2V4-BZX84C51, suffix 'B' is +/- 2% tolerance from BZX84B4V3-BZX84B51.
- Zener Voltage (Vz) Measurement. Guarantees the zener voltage when measured at 90 seconds while maintaining the lead temperature (TL) AT 30 °C, from the diode body.
- Zener Impedance (Zz) Derivation. The zener impedance is derived from the 60 cycle ac voltage, which results when an AC current having an rms value equal to 10% of the dc zener current (Izt or Izk) is superimposed on Izt or Izk.
- Surge Current (IR) Non-Repetitive. The rating listed in the electrical characteristics table is maximum peak, non-repetitive, reverse surge current of 1/2 square wave or equivalent sine wave pulse of 1/120 second duration superimposed on the test current, Izt, per JEDEC registration; however, actual device capability is as described in Figure 5.

BZX84 Series

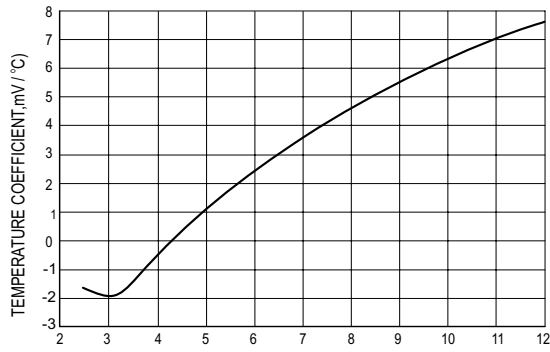

NOMINAL ZENER VOLTAGE, Volts

TYPICAL REVERSE CURRENT



NOMINAL ZENER VOLTAGE, Volts

TEMPERATURE COEFFICIENTS

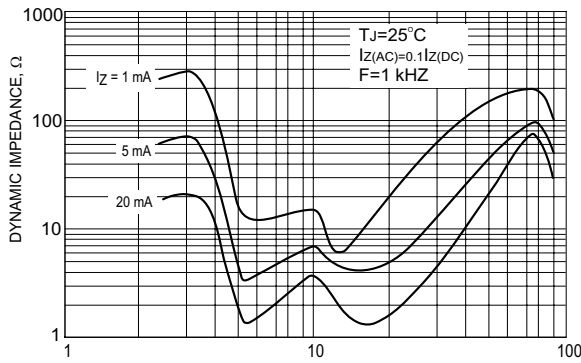

NORMAL ZENER VOLTAGE, Volts

EFFECT OF ZENER VOLTAGE ON ZENER IMPEDANCE

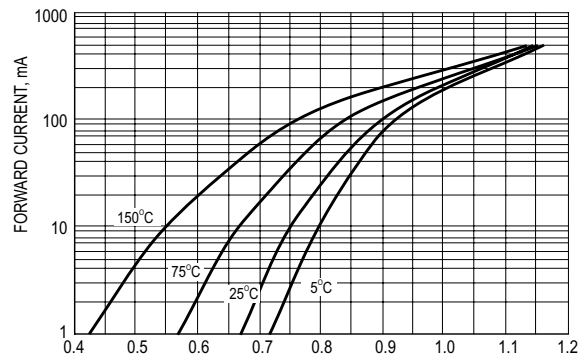

FORWARD VOLTAGE, Volts

TYPICAL FORWARD VOLTAGE

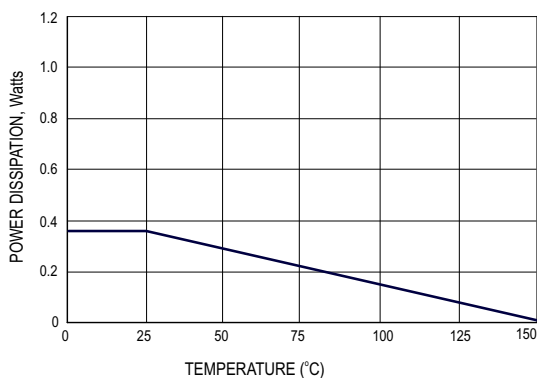

TEMPERATURE (°C)

STEADY STATE POWER DERATING

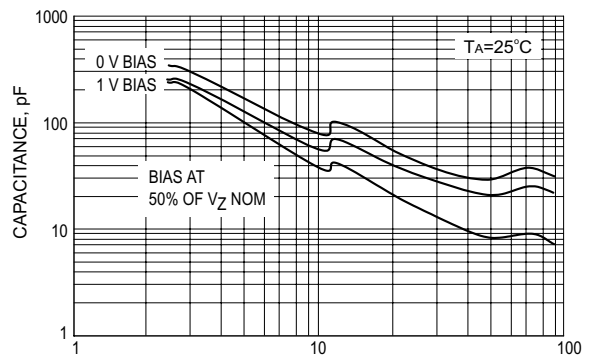

NOMINAL ZENER VOLTAGE, Volts

TYPICAL CAPACITANCE

BZX84 Series



ZENER VOLTAGE V.S. ZENER CURRENT



ZENER VOLTAGE V.S. ZENER CURRENT



TYPICAL LEAKAGE CURRENT



Micro Commercial Components

Ordering Information :

Device	Packing
Part Number-TP	Tape&Reel: 3Kpcs/Reel

Note : Adding "-HF" suffix for halogen free, eg. Part Number-TP-HF

IMPORTANT NOTICE

Micro Commercial Components Corp. reserves the right to make changes without further notice to any product herein to make corrections, modifications , enhancements , improvements , or other changes . **Micro Commercial Components Corp .** does not assume any liability arising out of the application or use of any product described herein; neither does it convey any license under its patent rights ,nor the rights of others . The user of products in such applications shall assume all risks of such use and will agree to hold **Micro Commercial Components Corp .** and all the companies whose products are represented on our website, harmless against all damages.

LIFE SUPPORT

MCC's products are not authorized for use as critical components in life support devices or systems without the express written approval of Micro Commercial Components Corporation.

CUSTOMER AWARENESS

Counterfeiting of semiconductor parts is a growing problem in the industry. Micro Commercial Components (MCC) is taking strong measures to protect ourselves and our customers from the proliferation of counterfeit parts. MCC strongly encourages customers to purchase MCC parts either directly from MCC or from Authorized MCC Distributors who are listed by country on our web page cited below. Products customers buy either from MCC directly or from Authorized MCC Distributors are genuine parts, have full traceability, meet MCC's quality standards for handling and storage. **MCC will not provide any warranty coverage or other assistance for parts bought from Unauthorized Sources.** MCC is committed to combat this global problem and encourage our customers to do their part in stopping this practice by buying direct or from authorized distributors.

www.mccsemi.com



Компания «ЭлектроПласт» предлагает заключение долгосрочных отношений при поставках импортных электронных компонентов на взаимовыгодных условиях!

Наши преимущества:

- Оперативные поставки широкого спектра электронных компонентов отечественного и импортного производства напрямую от производителей и с крупнейших мировых складов;
- Поставка более 17-ти миллионов наименований электронных компонентов;
- Поставка сложных, дефицитных, либо снятых с производства позиций;
- Оперативные сроки поставки под заказ (от 5 рабочих дней);
- Экспресс доставка в любую точку России;
- Техническая поддержка проекта, помощь в подборе аналогов, поставка прототипов;
- Система менеджмента качества сертифицирована по Международному стандарту ISO 9001;
- Лицензия ФСБ на осуществление работ с использованием сведений, составляющих государственную тайну;
- Поставка специализированных компонентов (Xilinx, Altera, Analog Devices, Intersil, Interpoint, Microsemi, Aeroflex, Peregrine, Syfer, Eurofarad, Texas Instrument, Miteq, Cobham, E2V, MA-COM, Hittite, Mini-Circuits, General Dynamics и др.);

Помимо этого, одним из направлений компании «ЭлектроПласт» является направление «Источники питания». Мы предлагаем Вам помощь Конструкторского отдела:

- Подбор оптимального решения, техническое обоснование при выборе компонента;
- Подбор аналогов;
- Консультации по применению компонента;
- Поставка образцов и прототипов;
- Техническая поддержка проекта;
- Защита от снятия компонента с производства.



Как с нами связаться

Телефон: 8 (812) 309 58 32 (многоканальный)

Факс: 8 (812) 320-02-42

Электронная почта: org@eplast1.ru

Адрес: 198099, г. Санкт-Петербург, ул. Калинина, дом 2, корпус 4, литера А.