

## MAX22344–MAX22346 Evaluation Kits

Evaluates: MAX22344–MAX22346

### General Description

The MAX22344–MAX22346 evaluation kits (EV kits) provide a proven design to evaluate the MAX22344–MAX22346, reinforced, four-channel, galvanic digital isolators. Two types of evaluation boards are available to support different channel direction configurations and different ENA polarities of the MAX22344–MAX22346 family. The MAX22345CSEVKIT# is fully assembled and tested, and comes populated with the MAX22345CAAP+ (Figure 1). The MAX2234XSEVKIT# is a generic board which has U1 unpopulated allowing the user to select a device from the MAX22344–MAX22346 family (Figure 2). Both evaluation boards support the 20-pin SSOP package type. See Table 1 for EV kit options.

The EV kits should be powered from two independent isolated power supplies with nominal output voltage in range from 1.71V to 5.5V. For evaluating the electrical parameters of the device without any isolation between the two sides, a single power supply can also be used.

The MAX2234XSEVKIT# comes with U1 unpopulated and supports the following digital isolators: MAX22344BAAP+, MAX22344CAAP+, MAX22345BAAP+, MAX22345CAAP+, MAX22345RAAP+, MAX22345SAAP+, MAX22346BAAP+, MAX22346CAAP+.

**Note:** When ordering the MAX2234XS EV kit, the engineer should request a sample of the desired MAX22344–MAX22346 isolator IC that can be soldered to the PCB.

### Features

- Broad Range of Data Transfer Rates (from DC to 200Mbps)
- Four Unidirectional Channels with 3 Different Channel Direction Configurations
- SMA Connectors for Easy Connection to External Equipment
- Wide Power Supply Voltage Range from 1.71V to 5.5V
- Guaranteed Up to 3.75kV<sub>RMS</sub> Isolation for 60s
- -40°C to +125°C Temperature Range
- Proven PCB Layout

Ordering Information appears at end of data sheet.

Table 1. EV Kit Options

EVKIT PART #	TARGET DEVICE	PACKAGE TYPE	COMMENT
MAX22345CSEVKIT#	MAX22345CAAP+	20-Pin SSOP	200Mbps IC Populated
MAX2234XSEVKIT#	Not Populated	20-Pin SSOP	Request Samples of Target Device from Maxim

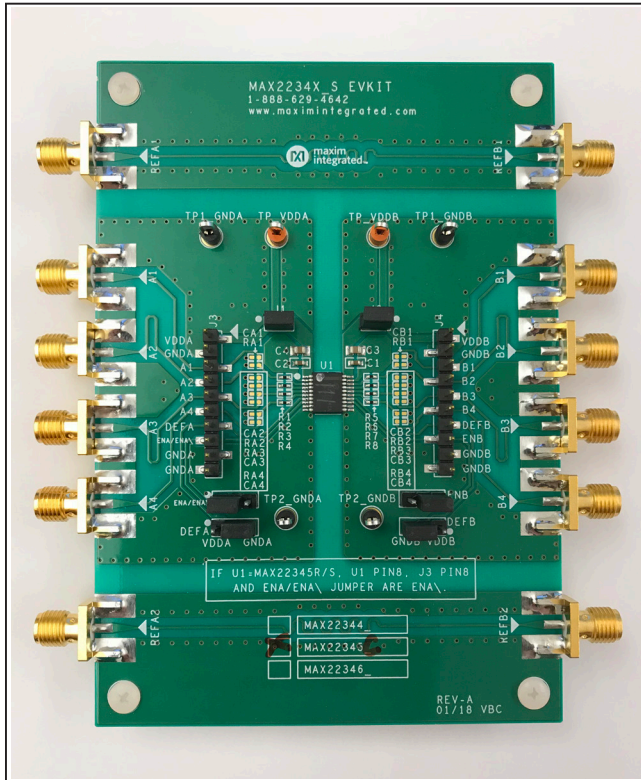

Figure 1. MAX22345CS EV KIT

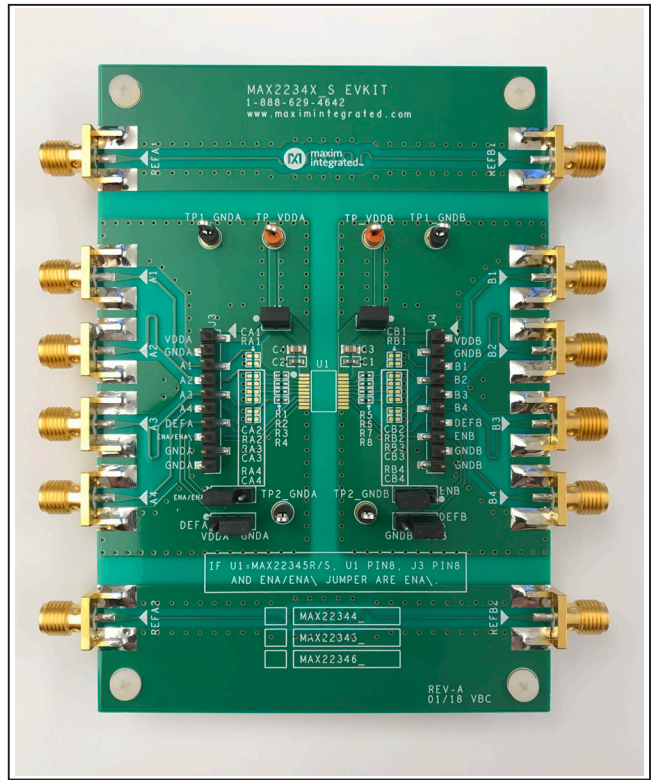

Figure 2. MAX2234XS EV KIT

**Quick Start**

**Required Equipment**

- MAX22345CS, or MAX2234XS EV kit
- MAX22344–MAX22346 device, if EV kit is not populated
- Two DC power supplies with output range of 1.71V to 5.5V
- Signal/function generator
- Oscilloscope

**Procedure**

The MAX22345CS EV kit is fully assembled and ready for evaluation. The MAX2234XS EV kit has everything except the DUT (U1) installed. The user can install the desired version of the MAX22344–MAX22346 family of reinforced, four-channel, unidirectional digital isolators. Once installed, follow the steps below to verify board functionality:

- 1) Verify jumper settings. See [Table 2](#) for all shunt positions.
  - J1 and J2 are closed.
  - Jumper ENA is either in 1-2 position if U1 ENA (pin 8) has active-high polarity, or in 2-3 position if U1 ENA (pin 8) has active-low polarity.
  - Jumper ENB is in 1-2 position.
  - Jumper DEFA and DEFB are in 2-3 position.
- 2) Connect one DC power supply between the EV kit's TP\_VDDA and TP1\_GNDA test points; connect the other DC power supply between TP\_VDDB and TP1\_GNDB test points.
- 3) Set both DC power supply outputs between 1.71V and 5.5V, and then enable the power supply output.
- 4) Connect the signal/function generator to an input SMA connector or test point of side A and observe the isolated signal on the corresponding side B output, using an oscilloscope. On the MAX22345CS EV kit, SMA connectors A1, A2, A3, and B4 are inputs, and SMA connectors B1, B2, B3, and A4 are outputs. Refer to [Table 3](#) for the SMA connector I/O configurations and jumper ENA configuration when a different MAX22344–MAX22346 device is installed as U1 on the MAX2234XS EV kit.

**Note:** It is also possible to power the EV kits from a single power supply to test electrical parameters but this invalidates the digital isolation of the IC.

**Table 2. MAX2234XS EV Kits Board Connectors and Shunt Positions**

CONNECTOR	SHUNT POSITION	DESCRIPTION
<b>SIDE A</b>		
J3	1	Test point or input header for V <sub>DDA</sub>
	2	Test point or input header for GNDA
	3	Test point or input header for I/O; same as A1 SMA
	4	Test point or input header for I/O; same as A2 SMA
	5	Test point or input header for I/O; same as A3 SMA
	6	Test point or input header for I/O; same as A4 SMA
	7	Test point or input header for side A default control; same as DEFA jumper pin 2
	8	Test point or input header for side A enable; same as ENA jumper pin 2
	9	Test point or input header for GNDA
	10	Test point or input header for GNDA
A1 (SMA)	n/a	I/O on side A
A2 (SMA)	n/a	I/O on side A
A3 (SMA)	n/a	I/O on side A
A4 (SMA)	n/a	I/O on side A
J1	Open	Use current meter to measure current of side A
	1-2*	Connect power supply to V <sub>DDA</sub>
DEFA	1-2	Connect side A default control pin to V <sub>DDA</sub> ; side A output default is set to high. Jumper DEFA must be set in the same position as DEFB
	2-3*	Connect side A default control pin to GNDA; side A output default is set to low. Jumper DEFA must be set in the same position as DEFB. Default setting on MAX22345CSEVKIT#
ENA	1-2*	Connect side A enable pin to V <sub>DDA</sub> ; side A outputs are enabled if ENA is active-high (MAX2234_B/C), or high-impedance if active-low (MAX22345R/S). Default setting on MAX22345CSEVKIT#
	2-3	Connect side A enable pin to GNDA; side A outputs are high-impedance if ENA is active-high (MAX2234_B/C), or enabled if active-low (MAX22345R/S)
	Open	Side A enable pin not connected; default setting on MAX2234XSEVKIT#

**Table 2. MAX2234XS EV Kits Board Connectors and Shunt Positions (continued)**

CONNECTOR	SHUNT POSITION	DESCRIPTION
<b>SIDE B</b>		
J4	1	Test point or input header for $V_{DDB}$
	2	Test point or input header for GNDB
	3	Test point or input header for I/O; same as B1 SMA
	4	Test point or input header for I/O; same as B2 SMA
	5	Test point or input header for I/O; same as B3 SMA
	6	Test point or input header for I/O; same as B4 SMA
	7	Test point or input header for side B default control; same as DEFB jumper pin 2
	8	Test point or input header for side B enable; same as ENB jumper pin 2
	9	Test point or input header for GNDB
	10	Test point or input header for GNDB
B1 (SMA)	n/a	I/O on side B
B2 (SMA)	n/a	I/O on side B
B3 (SMA)	n/a	I/O on side B
B4 (SMA)	n/a	I/O on side B
J2	Open	Use current meter to measure current of side B
	1-2*	Connect power supply to $V_{DDB}$
DEFB	1-2	Connect side B default control pin to $V_{DDB}$ ; side B output default is set to high. Jumper DEFB must be set in the same position as DEFA
	2-3*	Connect side B default control pin to GNDB; side B output default is set to low. Jumper DEFB must be set in the same position as DEFA. Default setting on MAX22345CSEVKIT#
ENB	1-2*	Connect side B enable pin to $V_{DDB}$ ; side B outputs are enabled. Default setting on MAX22345CSEVKIT#
	2-3	Connect side B enable pin to GNDB; side B outputs are high-impedance

\*Default configuration

**Table 3. MAX2234XS EV Kits Connector Configurations**

CONNECTOR	U1 DEVICE			
	MAX22344B/C	MAX22345B/C	MAX22345R/S	MAX22346B/C
<b>SIDE A</b>				
A1 (SMA)	IN1	IN1	IN1	IN1
A2 (SMA)	IN2	IN2	IN2	IN2
A3 (SMA)	IN3	IN3	IN3	OUT3
A4 (SMA)	IN4	OUT4	OUT4	OUT4
J3 PIN 8, ENA PIN 2	ENA	ENA	$\overline{ENA}$	ENA
<b>SIDE B</b>				
B1 (SMA)	OUT1	OUT1	OUT1	OUT1
B2 (SMA)	OUT2	OUT2	OUT2	OUT2
B3 (SMA)	OUT3	OUT3	OUT3	IN3
B4 (SMA)	OUT4	IN4	IN4	IN4
J4 PIN 8, ENB PIN 2	ENB	ENB	ENB	ENB

### Detailed Description of Hardware

The MAX22344–MAX22346 EV kits allow the user to evaluate the features of the MAX22344–MAX22346 four-channel digital isolators.

### External Power Supplies

Power to the MAX22345CS and MAX2234XS EV kits is derived from two external sources which can both be between +1.71V and +5.5V. Connect one source between the  $V_{DDA}$

and  $GNDA$  test points, and the other source between the  $V_{ddb}$  and  $GNDB$  test points. Each supply can be set independently and can be present over the entire range from +1.71V to +5.5V, regardless of the level or presence of the other supply. The MAX22344–MAX22346 level-shift the data, transmitting them across the isolation barrier.

Four SMA connectors on each side of the board allow easy connections to signal generator(s) and oscilloscope. A typical test setup is shown in [Figure 3](#).

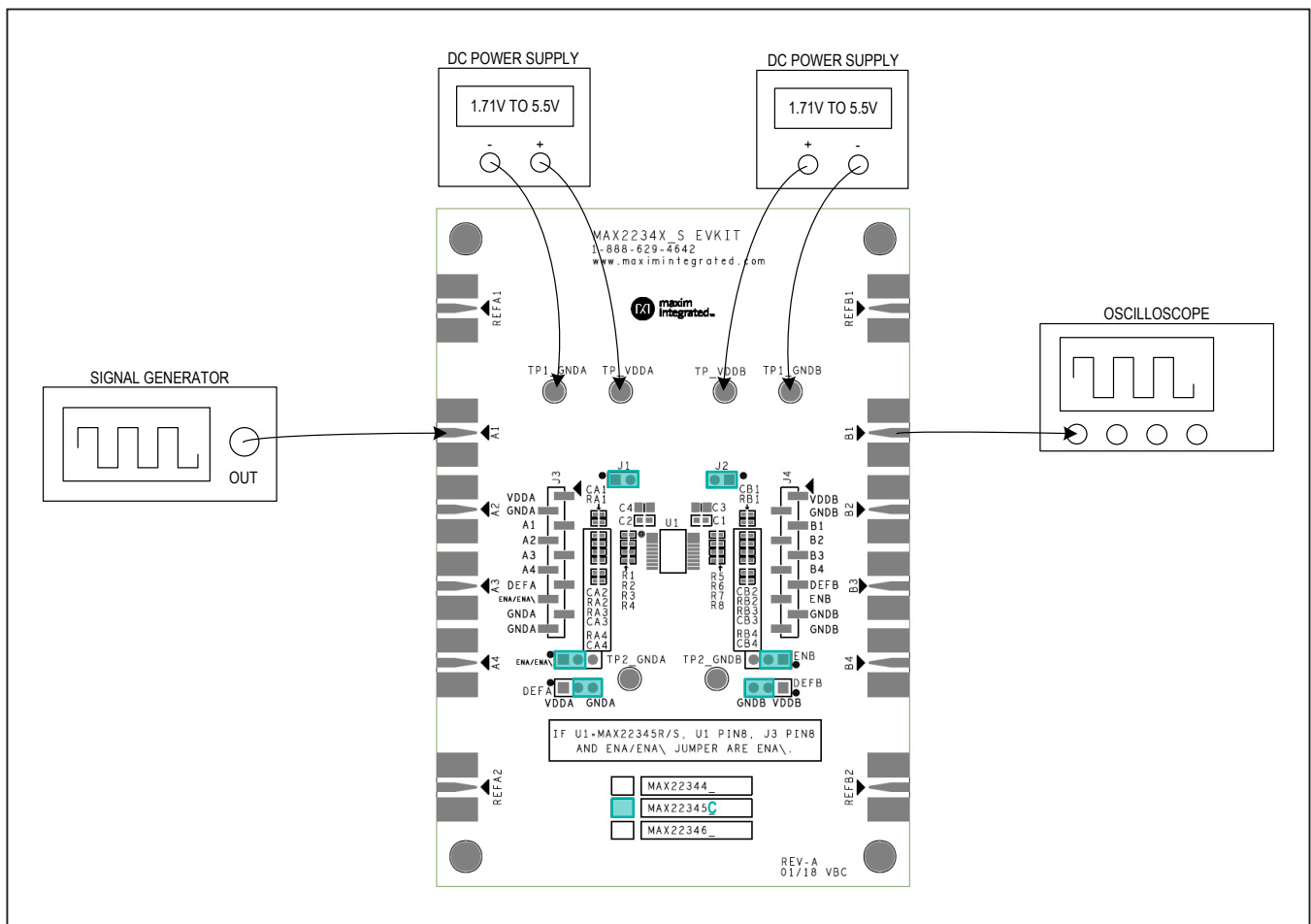

Figure 3. MAX2234XS EV Kit Typical Test Setup



## Decoupling Capacitors

Each power supply is decoupled with a 1 $\mu$ F ceramic capacitor in parallel with a 0.1 $\mu$ F ceramic capacitor, which are placed close to the U1 V<sub>DDA</sub> and V<sub>DDB</sub> pin.

## Shunt Positions

Jumpers J1 and J2 are installed between the external power supplies and U1 power supply pins to allow supply current measurement. Uninstall the J1 and J2 shunts and connect current meters on both side A and side B to measure the MAX22344–MAX22346 supply current.

Jumper ENA and ENB are provided to enable or disable the outputs of the MAX22344–MAX22346 isolator channels. To enable devices with an active-high enable pin (ENA) on side A (MAX2234\_B/C), connect the ENA shunt to V<sub>DDA</sub>. To enable devices with an active-low enable pin ( $\overline{\text{ENA}}$ ) on side A (MAX22345R/S), connect the ENA shunt to GNDA. Side A outputs are high-impedance when disabled. Connect the ENB shunt to V<sub>DDB</sub> to enable side B channels or connect to GNDB to disable side B channels. Side B outputs are high-impedance when disabled.

The MAX22344–MAX22346 feature user-selectable default-high or default-low outputs. To configure the default level of both side A and side B outputs to high, connect the DEFA shunt to V<sub>DDA</sub> and the DEFB shunt to V<sub>DDB</sub>. To configure the default level of the outputs to low, connect the DEFA shunt to GNDA and the DEFB shunt to GNDB. Ensure the logic state of DEFA is the same as that for DEFB. Configure DEFA and DEFB before powering up the board and do not toggle DEFA and DEFB during normal operation. See [Table 2](#) for all shunt positions and [Table 3](#) for connector configurations.

## I/O Traces Impedance Control

The input and output traces of all four isolation channels have an impedance control of 50 $\Omega$ . A 20 $\Omega$  series resistor is added to all input and output channels; along with the internal series resistance, it can provide 50 $\Omega$  impedance matching with external equipment such as function generators or oscilloscopes.

## Output Load

Each output has an unpopulated 0603 SMT resistor (RA1–RA4, RB1–RB4) and an unpopulated 0603 SMT capacitor (CA1–CA4, CB1–CB4) to GND\_ to allow different loads based on customer requirements.

## Calibration Channels

Two reference channels (REFA1–REFB1, REFA2–REFB2) are implemented on the EV kits to help calibrate the test setup for timing measurements such as propagation delay. Measure the propagation delay (t<sub>PD\_REF</sub>) using the reference channel first to determine the delay introduced by the test setup. Measure the propagation delay (t<sub>PD\_ISO</sub>) again using one of the MAX22344–MAX22346 data channels. The calibrated isolator delay is t<sub>PD\_ISO</sub> - t<sub>PD\_REF</sub>.

## U1 on the MAX2234XS EV Kit

U1 on the MAX2234XSEVKIT# is not installed. The user can install the desired version of the MAX22344–MAX22346 family of four-channel unidirectional digital isolators. The MAX22344–MAX22346 family offers three unidirectional channel configurations. The MAX22344 features all four channels transferring digital signals in one direction. SMA connectors A1–A4 on side A are input connectors and B1–B4 on side B are output connectors if the MAX22344 is installed as U1. The MAX22345 has three channels transmitting data in one direction and one channel transmitting in the opposite direction. SMA connectors A1–A3 and B4 are input connectors and B1–B3 and A4 are output connectors if the MAX22345 is installed as U1. The MAX22346 provides two channels in each direction. SMA connectors A1, A2, B3, and B4 are input connectors and B1, B2, A3 and A4 are output connectors if the MAX22346 is installed as U1. Refer to [Table 3](#) for SMA connector I/O configurations with different U1 selection.

When installing U1, make sure pin 1 of the device is mounted onto pin 1 of U1 on the PCB. Pin 1 is located at the upper-left corner of U1, denoted by a white dot on the silkscreen.

## Ordering Information

PART	TYPE
MAX22345CSEVKIT#*	EV Kit with installed MAX22345CAAP+
MAX2234XSEVKIT#	EV Kit for 20-pin SSOP package

#Denotes RoHS compliant.

\*Future product—contact factory for availability.

**MAX22344–MAX22346 EV Kit Bill of Materials**

ITEM	REF_DES		QTY	MFG PART #	MANUFACTURER	VALUE	DESCRIPTION	COMMENTS
1	A1-A4, B1-B4, REFA1, REFA2, REFB1, REFB2		12	142-0701-851	JOHNSON COMPONENTS	142-0701-851	CONNECTOR; END LAUNCH JACK RECEPTACLE; BOARDMOUNT; STRAIGHT THROUGH; 2PINS;	
2	C1, C2		2	GCM188R71H104KA12; GCM188R71H104K; CGA3E2X7R1H104K080AA	MURATA;MURATA;TDK	0.1µF	CAPACITOR; SMT (0603); CERAMIC CHIP; 0.1µF; 50V; TOL=10%; TG=-55°C TO +125°C; TC=X7R; AUTO	
3	C3, C4		2	GRM21BR71H105KA12; CL21B105KBFNNNE; C2012X7R1H105K085AC; UMK212B7105KG	MURATA;SAMSUNG ELECTRONICS;TDK;TAIYO YUDEN	1µF	CAPACITOR; SMT (0805); CERAMIC CHIP; 1µF; 50V; TOL=10%; TG=-55°C TO +125°C; TC=X7R	
4	ENA, ENB, DEFA, DEFB		4	PEC03SAAN	SULLINS	PEC03SAAN	CONNECTOR; MALE; THROUGH HOLE; BREAKAWAY; STRAIGHT; 3PINS	
5	J1, J2		2	PEC02SAAN	SULLINS	PEC02SAAN	CONNECTOR; MALE; THROUGH HOLE; BREAKAWAY; STRAIGHT; 2PINS	
6	J3, J4		2	1-1241150-0	TE CONNECTIVITY	1-1241150-0	CONNECTOR; MALE; SMT; AMPMODU II PIN HEADER; SINGLE ROW; PACKED IN BLISTER; STRAIGHT; 10PINS	
7	R1-R8		8	CRCW040220R0FK	VISHAY DALE	20	RESISTOR; 0402; 20 OHM; 1%; 100PPM; 0.063W; THICK FILM	
8	SU1-SU6		6	STC02SYAN	SULLINS ELECTRONICS CORP.	STC02SYAN	TEST POINT; JUMPER; STR; TOTAL LENGTH=0.256IN; BLACK; INSULATION=PBT CONTACT=PHOSPHOR BRONZE; COPPER PLATED TIN OVERALL	
9	TP1_GNDA, TP1_GNDB, TP2_GNDA, TP2_GNDB		4	5011	KEYSTONE	N/A	TEST POINT; PIN DIA=0.125IN; TOTAL LENGTH=0.445IN; BOARD HOLE=0.063IN; BLACK; PHOSPHOR BRONZE WIRE SILVER PLATE FINISH;	
10	TP_VDDA, TP_Vddb		2	5013	KEYSTONE	N/A	TEST POINT; PIN DIA=0.125IN; TOTAL LENGTH=0.445IN; BOARD HOLE=0.063IN; ORANGE; PHOSPHOR BRONZE WIRE SILVER PLATE FINISH;	
11	U1		1	MAX2234X	MAXIM	MAX2234X	EVKIT PART - IC; MAX2234X SERIES; PACKAGE DRAWING NUMBER: 21-0056; PACKAGE LAND PATTERN: 90-0094; PACKAGE CODE: A20MS+6; SSOP20	
12	PCB		1	MAX2234XS	MAXIM	PCB	PCB:MAX2234XS	-
13	MTH1-MTH4	DNI	4	1902B	GENERIC PART	N/A	STANDOFF; FEMALE-THREADED; HEX; 4-40IN; 3/8IN; NYLON	
14	MTH1-MTH4	DNI	4	P440.375	GENERIC PART	N/A	MACHINE SCREW; SLOTTED; PAN; 4-40IN; 3/8IN; NYLON	
15	RA1-RA4, RB1-RB4	DNP	0	N/A	N/A	OPEN	PACKAGE OUTLINE 0402 RESISTOR	
16	CA1-CA4, CB1-CB4	DNP	0	N/A	N/A	OPEN	PACKAGE OUTLINE 0402 NON-POLAR CAPACITOR	
TOTAL			54					

MAX22344–MAX22346 EV Kit Schematic

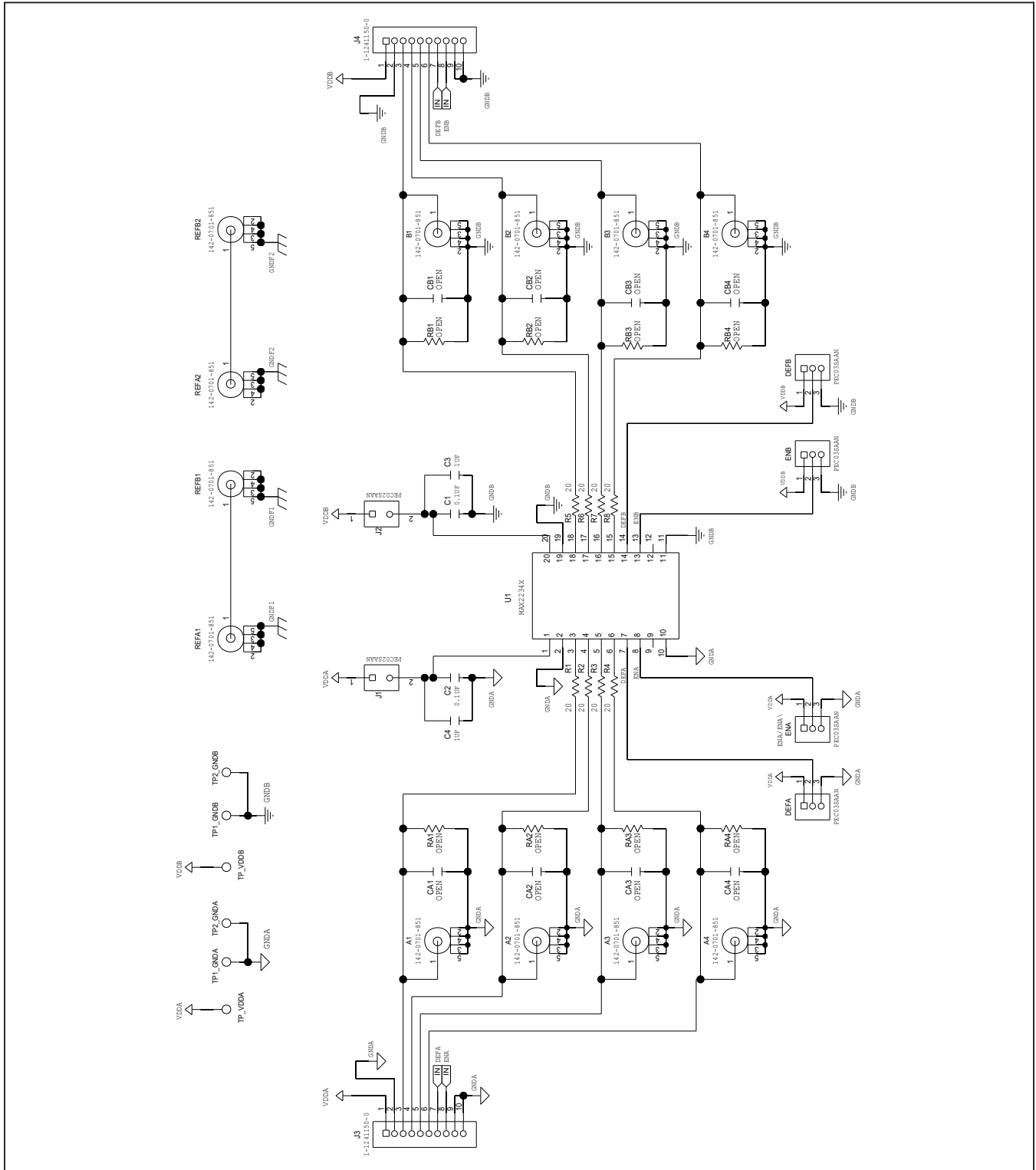



MAX22344–MAX22346 EV Kit PCB Layout Diagrams

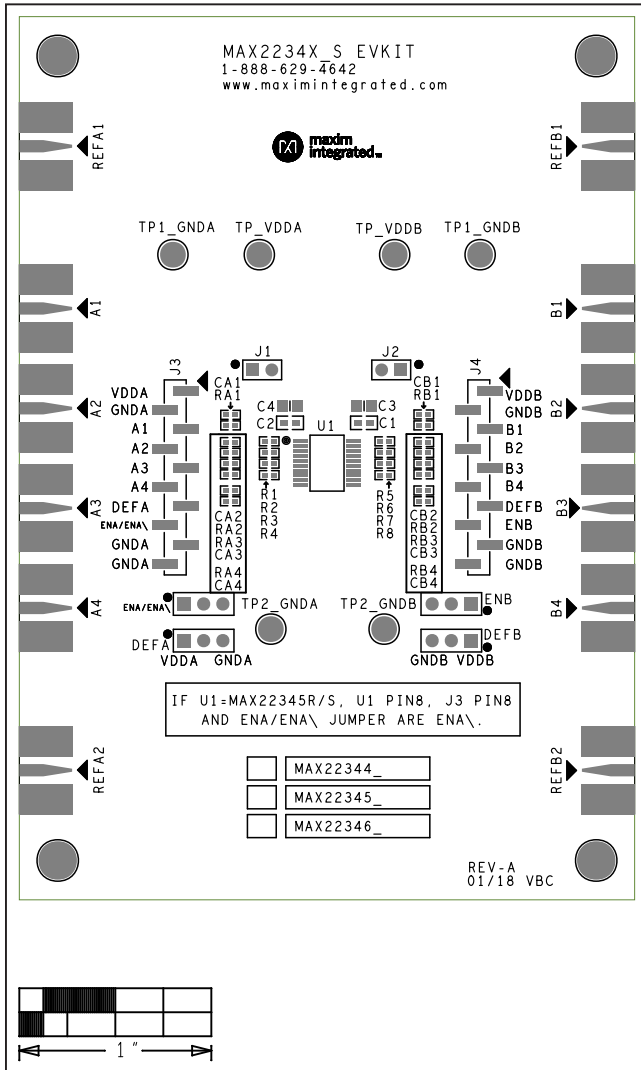

MAX22344–MAX22346 EV Kit—Top Silkscreen

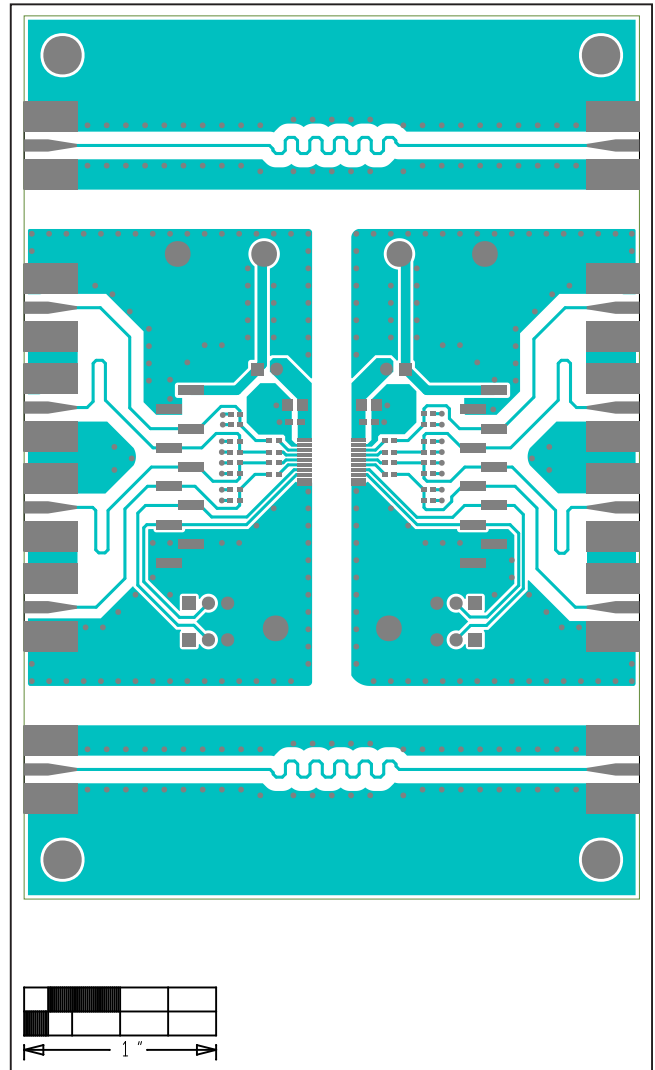

MAX22344–MAX22346 EV Kit—Top

MAX22344–MAX22346 EV Kit PCB Layout Diagrams (continued)

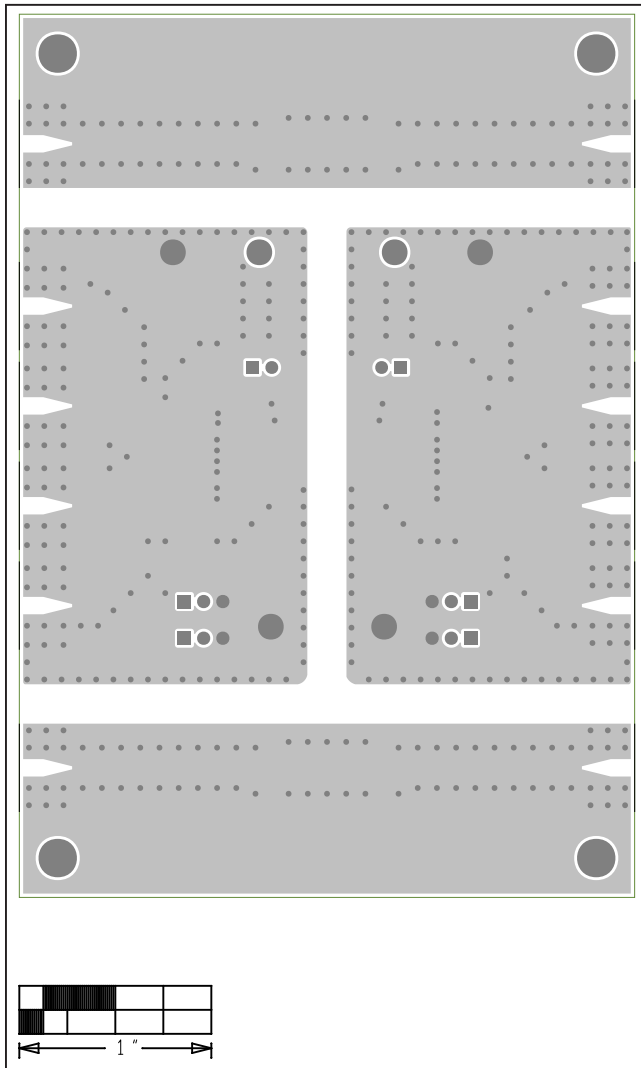

MAX22344–MAX22346 EV Kit—L2 GND

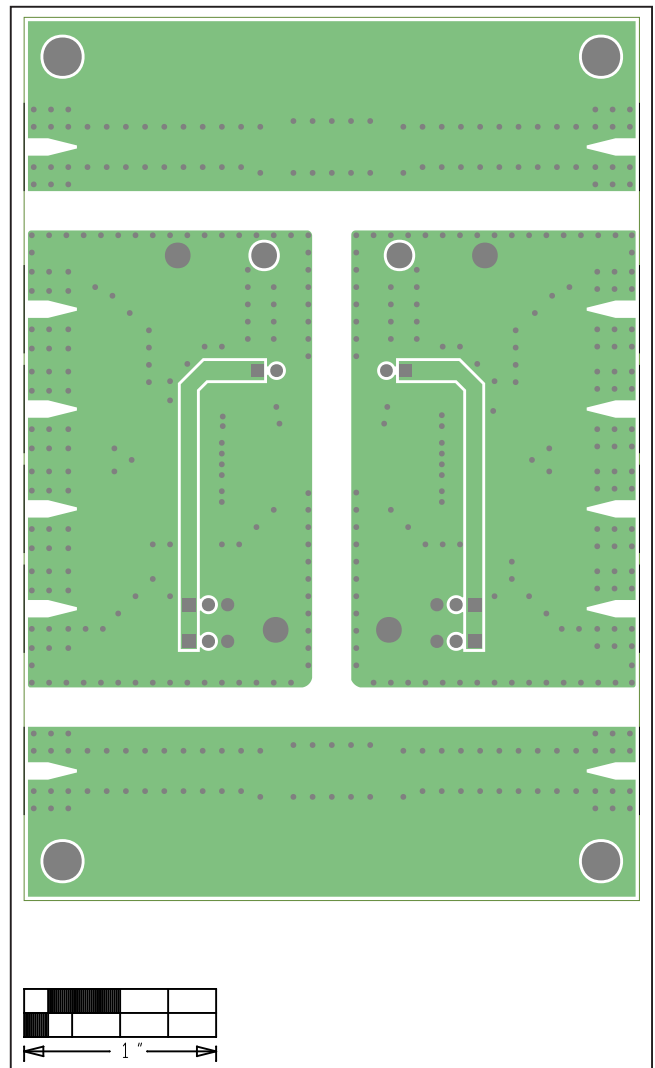

MAX22344–MAX22346 EV Kit—L3 PWR

MAX22344–MAX22346 EV Kit PCB Layout Diagrams (continued)

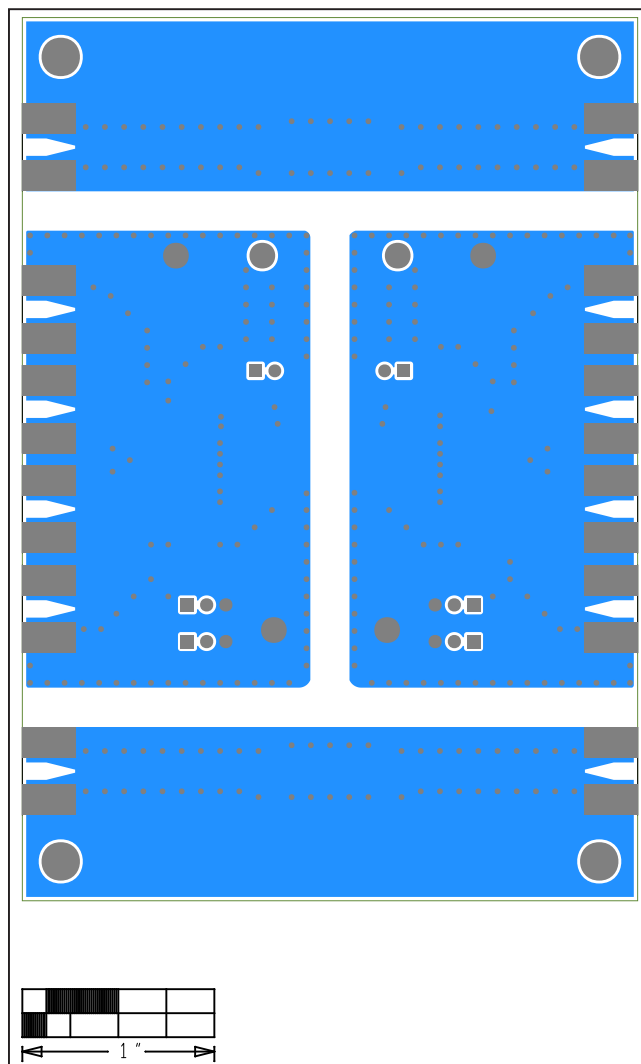

MAX22344–MAX22346 EV Kit—Bottom

## Revision History

REVISION NUMBER	REVISION DATE	DESCRIPTION	PAGES CHANGED
0	3/18	Initial release	—
1	10/18	Added future product designation to MAX22345CSEVKIT# in the <i>Ordering Information</i> table	6

For pricing, delivery, and ordering information, please visit Maxim Integrated's online storefront at <https://www.maximintegrated.com/en/storefront/storefront.html>.

*Maxim Integrated cannot assume responsibility for use of any circuitry other than circuitry entirely embodied in a Maxim Integrated product. No circuit patent licenses are implied. Maxim Integrated reserves the right to change the circuitry and specifications without notice at any time.*



Компания «ЭлектроПласт» предлагает заключение долгосрочных отношений при поставках импортных электронных компонентов на взаимовыгодных условиях!

Наши преимущества:

- Оперативные поставки широкого спектра электронных компонентов отечественного и импортного производства напрямую от производителей и с крупнейших мировых складов;
- Поставка более 17-ти миллионов наименований электронных компонентов;
- Поставка сложных, дефицитных, либо снятых с производства позиций;
- Оперативные сроки поставки под заказ (от 5 рабочих дней);
- Экспресс доставка в любую точку России;
- Техническая поддержка проекта, помощь в подборе аналогов, поставка прототипов;
- Система менеджмента качества сертифицирована по Международному стандарту ISO 9001;
- Лицензия ФСБ на осуществление работ с использованием сведений, составляющих государственную тайну;
- Поставка специализированных компонентов (Xilinx, Altera, Analog Devices, Intersil, Interpoint, Microsemi, Aeroflex, Peregrine, Syfer, Eurofarad, Texas Instrument, Miteq, Cobham, E2V, MA-COM, Hittite, Mini-Circuits, General Dynamics и др.);

Помимо этого, одним из направлений компании «ЭлектроПласт» является направление «Источники питания». Мы предлагаем Вам помощь Конструкторского отдела:

- Подбор оптимального решения, техническое обоснование при выборе компонента;
- Подбор аналогов;
- Консультации по применению компонента;
- Поставка образцов и прототипов;
- Техническая поддержка проекта;
- Защита от снятия компонента с производства.



#### Как с нами связаться

**Телефон:** 8 (812) 309 58 32 (многоканальный)

**Факс:** 8 (812) 320-02-42

**Электронная почта:** [org@eplast1.ru](mailto:org@eplast1.ru)

**Адрес:** 198099, г. Санкт-Петербург, ул. Калинина, дом 2, корпус 4, литера А.