

Overview

The A72 Series is constructed of polypropylene film and metal foil or metallized film and metal foil with axial leads of tinned wire. The axial leads are electrically welded to the metal layer on the ends of the capacitor winding. The capacitor is encapsulated in a polyester tape wrapping case with thermosetting resin material. Two different winding constructions are used depending on voltage parameters. Please see the Performance Characteristics for more information.

Applications

Typical applications include resonant circuit, high frequency medium to high current, silicon-controlled rectifier (SCR and IGBT) as well as applications with high voltage and medium to high current.

Not suitable for across-the-line application (see Suppressor Capacitors).

Benefits

- Voltage range: 100 – 2,000 VDC
- Capacitance range: 47 pF – 0.33 μ F
- Diameter: 5 – 22.5 mm
- Length: 11 – 33 mm
- Capacitance tolerance: \pm 5%, \pm 10%, \pm 20%
- Climatic category: 55/105/56 IEC 60068-1
- Operating temperature range of -55°C to +105°C
- RoHS compliance and lead-free terminations
- Tape & Reel packaging in accordance with IEC 60286-1
- Self-healing

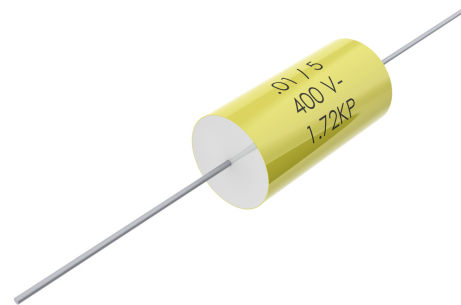

Part Number System

| A72 | E | F | 1470 | AA | 00 | J |
|-------------------------|--|--|--|----------------------------|-------------------|--|
| Series | Rated Voltage (VDC) | Length (mm) | Capacitance Code (pF) | Packaging | Internal Use | Capacitance Tolerance |
| Polypropylene Film/Foil | E = 100 I = 250 M = 400 P = 630 Q = 1000 S = 1500 U = 2000 | F = 11 H = 14 K = 20.5 Q = 28 T = 33 | The last three digits represent significant figures. The first digit specifies the total number of zeros to be added. | See Ordering Options Table | 00, 02 (Standard) | J = \pm 5% K = \pm 10% M = \pm 20% |

Ordering Options Table

| Type of Leads and Packaging | Lead Length (mm) | Lead and Packaging Code |
|--------------------------------------|---------------------------|-------------------------|
| Bulk (Bag) – Short Leads | 40 ±5 | AA |
| Tape & Reel (Standard Reel Ø 355 mm) | H ₀ =18.5 ±0.5 | 26 |

Dimensions – Millimeters

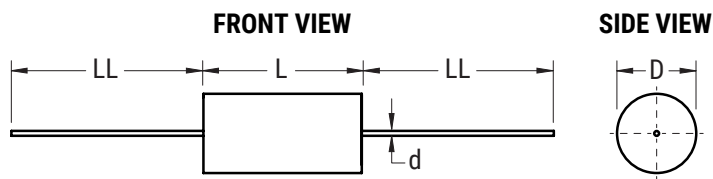

| D | | L | | d | |
|---------|-----------|---------|-----------|---------|-----------|
| Nominal | Tolerance | Nominal | Tolerance | Nominal | Tolerance |
| 5.0 | Maximum | 11.0 | Maximum | 0.5 | ±0.05 |
| 6.5 | Maximum | 16.5 | Maximum | 0.6 | ±0.05 |
| 7.0 | Maximum | 16.5 | Maximum | 0.6 | ±0.05 |
| 7.5 | Maximum | 16.5 | Maximum | 0.6 | ±0.05 |
| 8.0 | Maximum | 16.5 | Maximum | 0.8 | ±0.05 |
| 8.0 | Maximum | 20.5 | Maximum | 0.8 | ±0.05 |
| 8.0 | Maximum | 28.0 | Maximum | 0.8 | ±0.05 |
| 8.5 | Maximum | 16.5 | Maximum | 0.8 | ±0.05 |
| 8.5 | Maximum | 20.5 | Maximum | 0.8 | ±0.05 |
| 8.5 | Maximum | 28.0 | Maximum | 0.8 | ±0.05 |
| 9.0 | Maximum | 16.5 | Maximum | 0.8 | ±0.05 |
| 9.0 | Maximum | 28.0 | Maximum | 0.8 | ±0.05 |
| 9.5 | Maximum | 20.5 | Maximum | 0.8 | ±0.05 |
| 9.5 | Maximum | 28.0 | Maximum | 0.8 | ±0.05 |
| 10.0 | Maximum | 28.0 | Maximum | 0.8 | ±0.05 |

Note: See Ordering Options Table for lead length (LL / l) options.

| D | | L | | d | |
|---------|-----------|---------|-----------|---------|-----------|
| Nominal | Tolerance | Nominal | Tolerance | Nominal | Tolerance |
| 11.0 | Maximum | 20.5 | Maximum | 0.8 | ±0.05 |
| 11.0 | Maximum | 28.0 | Maximum | 0.8 | ±0.05 |
| 11.5 | Maximum | 28.0 | Maximum | 0.8 | ±0.05 |
| 12.5 | Maximum | 28.0 | Maximum | 0.8 | ±0.05 |
| 13.0 | Maximum | 28.0 | Maximum | 0.8 | ±0.05 |
| 13.5 | Maximum | 28.0 | Maximum | 0.8 | ±0.05 |
| 13.5 | Maximum | 33.0 | Maximum | 0.8 | ±0.05 |
| 14.0 | Maximum | 33.0 | Maximum | 0.8 | ±0.05 |
| 16.0 | Maximum | 33.0 | Maximum | 1.0 | ±0.05 |
| 16.5 | Maximum | 33.0 | Maximum | 1.0 | ±0.05 |
| 18.0 | Maximum | 33.0 | Maximum | 1.0 | ±0.05 |
| 19.0 | Maximum | 33.0 | Maximum | 1.0 | ±0.05 |
| 19.5 | Maximum | 33.0 | Maximum | 1.0 | ±0.05 |
| 20.0 | Maximum | 33.0 | Maximum | 1.0 | ±0.05 |
| 22.5 | Maximum | 33.0 | Maximum | 1.0 | ±0.05 |

Note: See Ordering Options Table for lead length (LL / l) options.

Performance Characteristics

| | | | | | | | |
|----------------------------------|--|----------------|-----------------|--------------|--------------|----------------|---------------|
| Dielectric | Polypropylene film | | | | | | |
| Plates | Metal foil for 1 section, metal foil + metallized film for 2 sections | | | | | | |
| Winding | Non-inductive type | | | | | | |
| Leads | Tinned wire | | | | | | |
| Protection | Plastic case, thermosetting resin filled. Box material is solvent resistant and flame retardant according to UL94. | | | | | | |
| Related Documents | IEC 60384-13 | | | | | | |
| Sections | 1 | | | 2 | | | |
| Voltage Range (VDC) | 100 | 250 | 400 | 630 | 1,000 | 1,500 | 2,000 |
| Voltage Range (VAC) | 63 | 125 | 160 | 300 | 400 | 450 | 500 |
| Capacitance Range (µF) | 0.0047 – 0.01 | 0.0022 – 0.015 | 0.000047 – 0.01 | 0.015 – 0.33 | 0.0033 – 0.1 | 0.0022 – 0.068 | 0.001 – 0.047 |
| Capacitance Values | E6 series (IEC 60063) measured at 1 kHz and +20 ±1°C | | | | | | |
| Capacitance Tolerance | ±5%, ±10%, ±20% | | | | | | |
| Operating temperature Range | -55°C to +105°C | | | | | | |
| Maximum Self-heating | 10°C at Rated Temperature | | | | | | |
| Rated Temperature T _R | +85°C | | | | | | |
| Voltage Derating | Above +85°C DC and AC voltage derating is 1.25%/°C | | | | | | |
| Climatic Category | 55/105/56 IEC 60068-1 | | | | | | |

Maximum Humidity in Storage Conditions

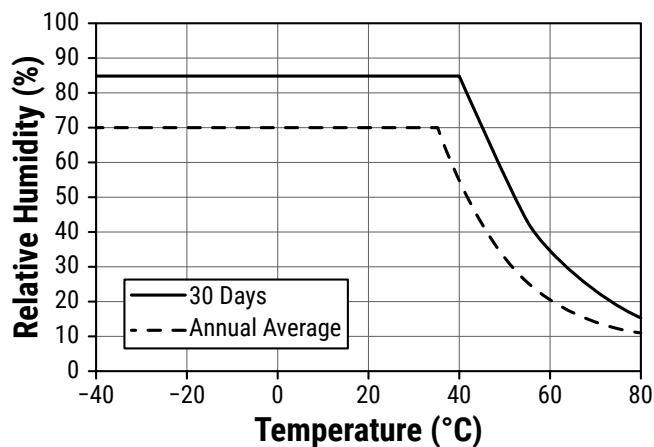

Performance Characteristics cont.

| | | | |
|---|---|------------|------------|
| Storage Conditions | Storage time: ≤ 24 months from the date marked on the package label | | |
| | Average relative humidity per year ≤ 70% | | |
| | RH ≤ 85% for 30 days randomly distributed throughout the year | | |
| | Dew is absent | | |
| | Temperature: -40 to 80°C (see "Maximum Humidity in Storage Conditions" graph below) | | |
| Test Voltage | 2 x V _R VDC for 2 s (between terminations) at +25°C ±5°C | | |
| Capacitance Drift | Maximum 0.5% after a 2 year storage period at a temperature of +10°C to +40°C and a relative humidity of 40% to 60% | | |
| Maximum Pulse Steepness | dV/dt according to Table 1. For working voltages lower than rated voltage (V < V _R), the specified dV/dt can be multiplied by the factor V _R /V. | | |
| Temperature Coefficient | -(150 ±70) ppm/°C at 1 kHz | | |
| Self Inductance (Lead Length ~ 2 mm) | Maximum 1 nH per 1 mm lead and capacitor length. | | |
| Dissipation Factor tanδ | Maximum Values at 25°C ±5°C | | |
| | Frequency | C ≤ 0.1 μF | C ≥ 0.1 μF |
| | 10 kHz | 0.05% | 0.05% |
| | 100 kHz | 0.10% | - |
| Insulation Resistance | Measured at +25°C, 100 VDC 60 seconds | | |
| | Minimum Values Between Terminals | | |
| | All Capacitance Values | | |
| | ≥ 100,000 MΩ (≥ 500,000 MΩ)* | | |

* Typical value

Maximum Voltage (V_{rms}) vs. Frequency (Sinusoidal Waveform/ $Th \leq +40^\circ C$)

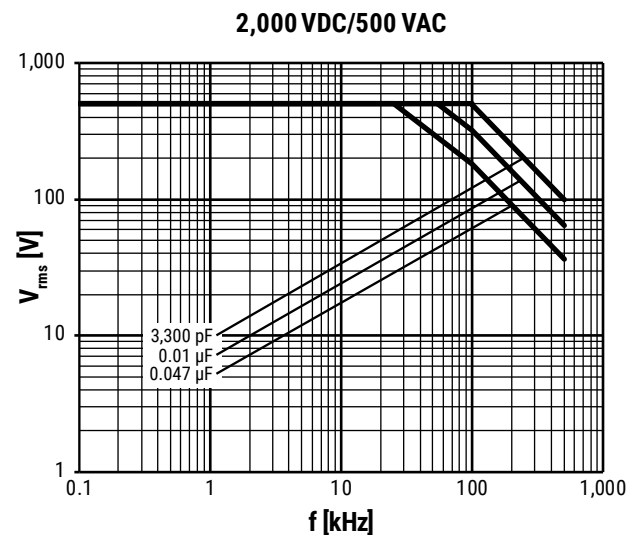
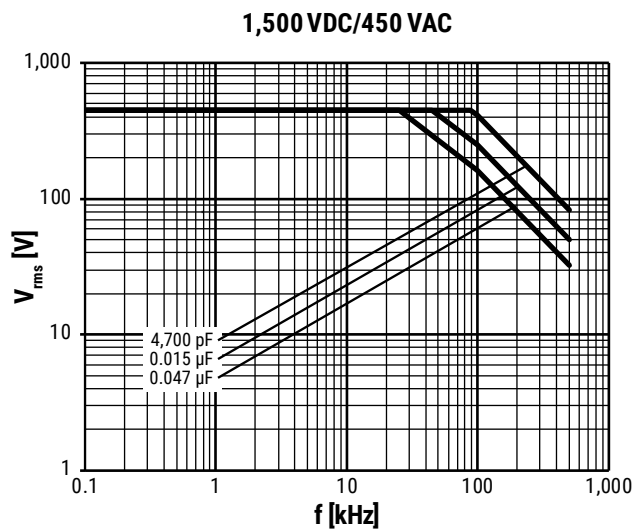
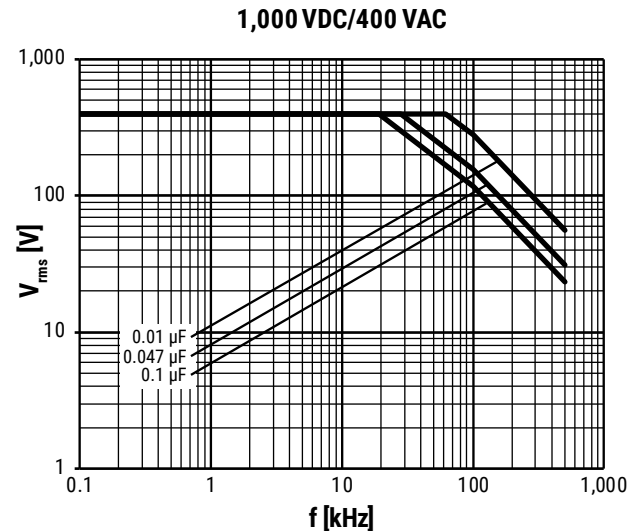
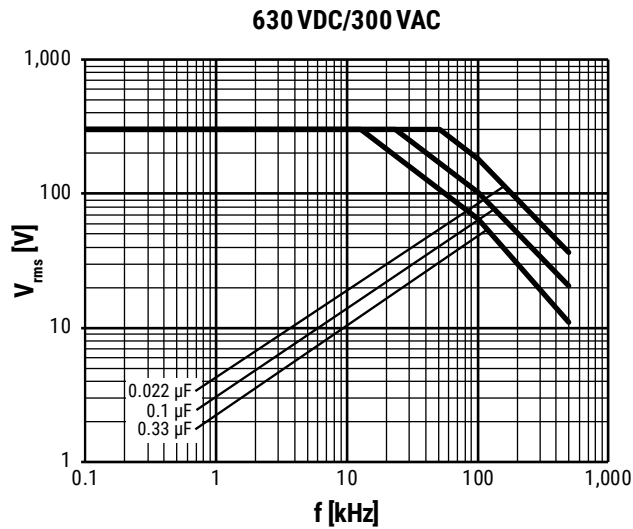
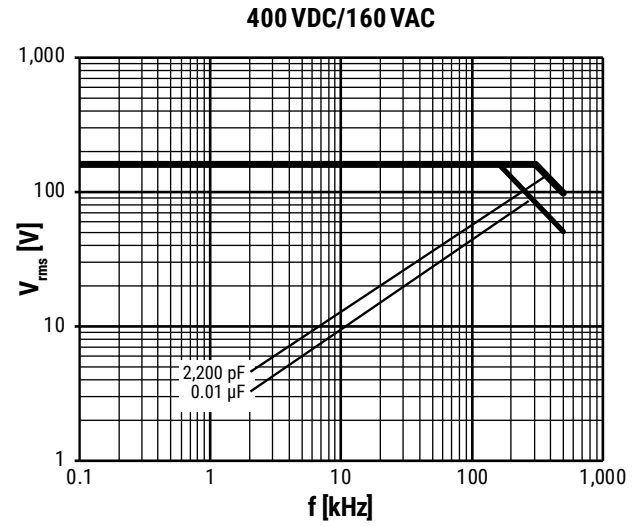
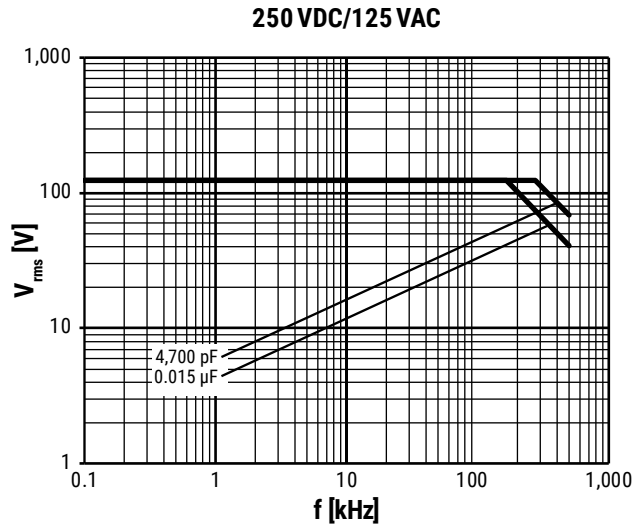

Maximum Current (I_{rms}) vs. Frequency (Sinusoidal Waveform/ $Th \leq +40^\circ C$)

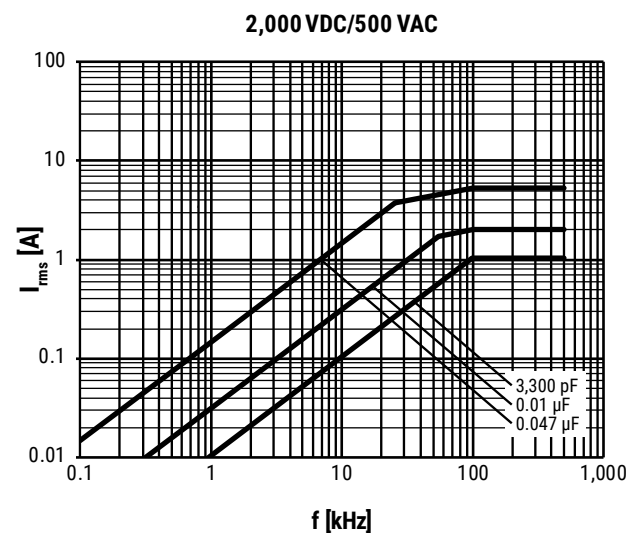
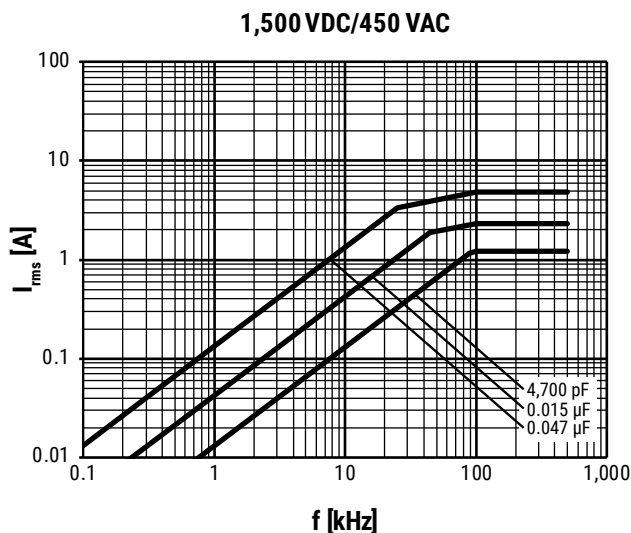
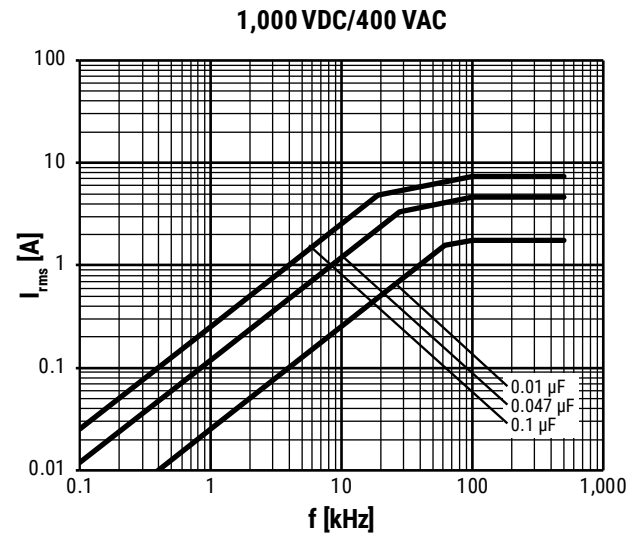
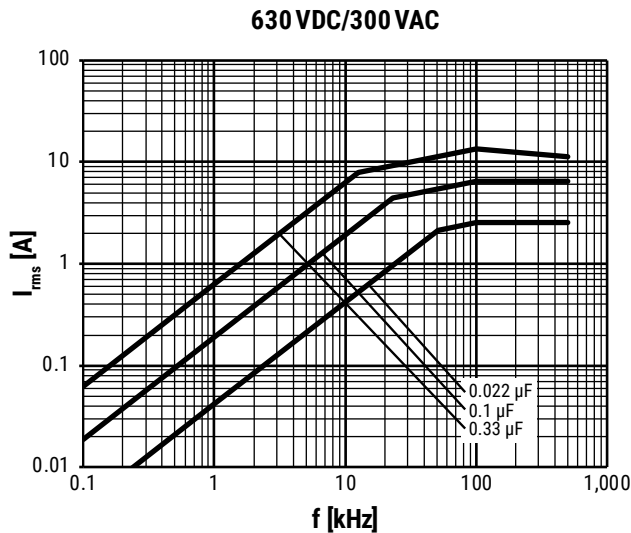
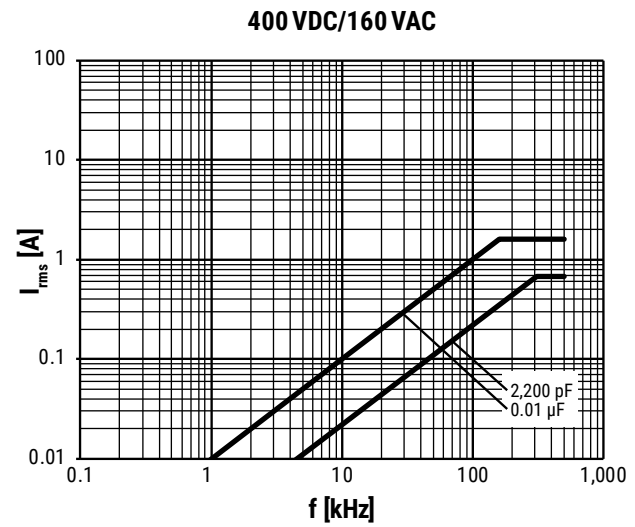
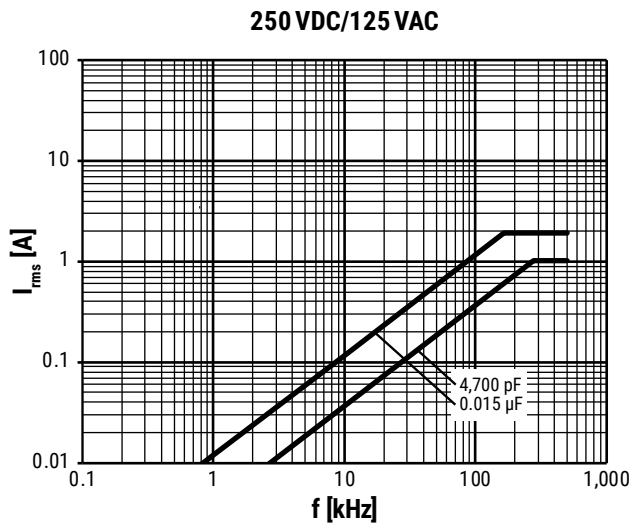

Environmental Test Data

| Damp Heat, Steady State Test | Test Conditions: | | Performances |
|-----------------------------------|----------------------------------|------------------------------------|--|
| | Temperature: | +40°C ±2°C | Δ C/C ≤ 2%, Δ tanδ ≤ 0.0005 at 1 kHz IR after test ≥ 50% of initial limit |
| | Relative humidity (RH): | 93% ±2% | |
| | Test duration: | 56 days | |
| Endurance Test | Test Conditions | | Performances |
| | Temperature: | +85°C ±2°C | Δ C/C ≤ 2%, Δ tanδ ≤ 0.0005 at 1 kHz IR after test ≥ 50% of initial limit |
| | Voltage applied: | 1.5 x V _R (DC) | |
| | Test duration: | 1,000 hours | |
| Resistance to Soldering Heat Test | Test Conditions | | Performances |
| | Solder bath temperature: | 260°C ±5°C 10 seconds ±1 second | Δ C/C ≤ 1%, Δ tanδ ≤ 0.0005 at 1 kHz IR after test ≥ initial limit |
| | Dipping time (with heat screen): | | |

Environmental Compliance

All KEMET pulse capacitors are RoHS Compliant, except A72 Series components with letter "F" (L Max = 11mm) in the 4th digit of the KEMET Part Number and 5th digit of the Customer Part Number.

Table 1 – Ratings & Part Number Reference

| VDC | VAC | Capacitance Value (μF) | Dimensions in mm | | dV/dt (V/μs) | Max K ₀ (V ² /μs) | KEMET Internal Part Number | Customer Part Number |
|-----|-----|------------------------|------------------|--------|--------------|---|----------------------------|----------------------|
| | | | D Max | L Max | | | | |
| 100 | 63 | 0.0047 | 5.0 | 11.0 | 3,000 | 600,000 | 72EF1470(1)00(2) | A72EF1470(1)00(2) |
| 100 | 63 | 0.0068 | 5.0 | 11.0 | 3,000 | 600,000 | 72EF1680(1)00(2) | A72EF1680(1)00(2) |
| 100 | 63 | 0.010 | 5.0 | 11.0 | 3,000 | 600,000 | 72EF2100(1)00(2) | A72EF2100(1)00(2) |
| 250 | 125 | 0.0022 | 5.0 | 11.0 | 5,000 | 2,500,000 | 72IF1220(1)00(2) | A72IF1220(1)00(2) |
| 250 | 125 | 0.0033 | 5.0 | 11.0 | 5,000 | 2,500,000 | 72IF1330(1)00(2) | A72IF1330(1)00(2) |
| 250 | 125 | 0.0047 | 7.0 | 16.5 | 4,500 | 2,250,000 | 72II1470(1)00(2) | A72II1470(1)00(2) |
| 250 | 125 | 0.0068 | 7.0 | 16.5 | 4,500 | 2,250,000 | 72II1680(1)00(2) | A72II1680(1)00(2) |
| 250 | 125 | 0.010 | 7.5 | 16.5 | 4,500 | 2,250,000 | 72II2100(1)00(2) | A72II2100(1)00(2) |
| 250 | 125 | 0.015 | 8.5 | 16.5 | 4,500 | 2,250,000 | 72II2150(1)00(2) | A72II2150(1)00(2) |
| 400 | 160 | 0.000047 | 5.0 | 11.0 | 13,000 | 10,400,000 | 72MF0047(1)00(2) | A72MF0047(1)00(2) |
| 400 | 160 | 0.000068 | 5.0 | 11.0 | 13,000 | 10,400,000 | 72MF0068(1)00(2) | A72MF0068(1)00(2) |
| 400 | 160 | 0.00010 | 5.0 | 11.0 | 13,000 | 10,400,000 | 72MF0100(1)00(2) | A72MF0100(1)00(2) |
| 400 | 160 | 0.00015 | 5.0 | 11.0 | 13,000 | 10,400,000 | 72MF0150(1)00(2) | A72MF0150(1)00(2) |
| 400 | 160 | 0.00022 | 5.0 | 11.0 | 13,000 | 10,400,000 | 72MF0220(1)00(2) | A72MF0220(1)00(2) |
| 400 | 160 | 0.00033 | 5.0 | 11.0 | 13,000 | 10,400,000 | 72MF0330(1)00(2) | A72MF0330(1)00(2) |
| 400 | 160 | 0.00047 | 5.0 | 11.0 | 13,000 | 10,400,000 | 72MF0470(1)00(2) | A72MF0470(1)00(2) |
| 400 | 160 | 0.00068 | 5.0 | 11.0 | 13,000 | 10,400,000 | 72MF0680(1)00(2) | A72MF0680(1)00(2) |
| 400 | 160 | 0.0010 | 5.0 | 11.0 | 13,000 | 10,400,000 | 72MF1100(1)00(2) | A72MF1100(1)00(2) |
| 400 | 160 | 0.0015 | 5.0 | 11.0 | 13,000 | 10,400,000 | 72MF1150(1)00(2) | A72MF1150(1)00(2) |
| 400 | 160 | 0.0022 | 6.5 | 16.5 | 6,500 | 5,200,000 | 72MI1220(1)00(2) | A72MI1220(1)00(2) |
| 400 | 160 | 0.0033 | 6.5 | 16.5 | 6,500 | 5,200,000 | 72MI1330(1)00(2) | A72MI1330(1)00(2) |
| 400 | 160 | 0.0047 | 7.0 | 16.5 | 6,500 | 5,200,000 | 72MI1470(1)00(2) | A72MI1470(1)00(2) |
| VDC | VAC | Capacitance Value (μF) | B (mm) | H (mm) | dV/dt (V/μs) | Max K ₀ (V ² /μs) | KEMET Internal Part Number | Customer Part Number |

(1) Insert lead and packaging code. See Ordering Options Table for available options.

(2) J = 5%, K = 10%, M = 20%.

Table 1 – Ratings & Part Number Reference cont.

| VDC | VAC | Capacitance Value (µF) | Dimensions in mm | | dV/dt (V/µs) | Max K ₀ (V ² /µs) | KEMET Internal Part Number | Customer Part Number |
|-------|-----|------------------------|------------------|--------|--------------|---|----------------------------|----------------------|
| | | | D Max | L Max | | | | |
| 400 | 160 | 0.0068 | 8.0 | 16.5 | 6,500 | 5,200,000 | 72MI1680(1)00(2) | A72MI1680(1)00(2) |
| 400 | 160 | 0.010 | 9.0 | 16.5 | 6,500 | 5,200,000 | 72MI2100(1)00(2) | A72MI2100(1)00(2) |
| 630 | 300 | 0.015 | 8.5 | 20.5 | 4,300 | 5,418,000 | 72PK2150(1)00(2) | A72PK2150(1)00(2) |
| 630 | 300 | 0.022 | 9.5 | 20.5 | 4,300 | 5,418,000 | 72PK2220(1)00(2) | A72PK2220(1)00(2) |
| 630 | 300 | 0.033 | 9.0 | 28.0 | 2,600 | 3,276,000 | 72PQ2330(1)00(2) | A72PQ2330(1)00(2) |
| 630 | 300 | 0.047 | 10.0 | 28.0 | 2,600 | 3,276,000 | 72PQ2470(1)00(2) | A72PQ2470(1)00(2) |
| 630 | 300 | 0.068 | 11.5 | 28.0 | 2,600 | 3,276,000 | 72PQ2680(1)00(2) | A72PQ2680(1)00(2) |
| 630 | 300 | 0.10 | 13.5 | 28.0 | 2,600 | 3,276,000 | 72PQ3100(1)00(2) | A72PQ3100(1)00(2) |
| 630 | 300 | 0.15 | 14.0 | 33.0 | 1,800 | 2,268,000 | 72PT3150(1)00(2) | A72PT3150(1)00(2) |
| 630 | 300 | 0.22 | 16.5 | 33.0 | 1,800 | 2,268,000 | 72PT3220(1)00(2) | A72PT3220(1)00(2) |
| 630 | 300 | 0.33 | 19.5 | 33.0 | 1,800 | 2,268,000 | 72PT3330(1)00(2) | A72PT3330(1)00(2) |
| 1,000 | 400 | 0.0033 | 8.5 | 20.5 | 14,000 | 28,000,000 | 72QK1330(1)02(2) | A72QK1330(1)02(2) |
| 1,000 | 400 | 0.0047 | 9.5 | 20.5 | 14,000 | 28,000,000 | 72QK1470(1)02(2) | A72QK1470(1)02(2) |
| 1,000 | 400 | 0.0068 | 8.0 | 28.0 | 5,000 | 10,000,000 | 72QQ1680(1)02(2) | A72QQ1680(1)02(2) |
| 1,000 | 400 | 0.010 | 8.5 | 28.0 | 5,000 | 10,000,000 | 72QQ2100(1)02(2) | A72QQ2100(1)02(2) |
| 1,000 | 400 | 0.015 | 10.0 | 28.0 | 5,000 | 10,000,000 | 72QQ2150(1)02(2) | A72QQ2150(1)02(2) |
| 1,000 | 400 | 0.022 | 11.0 | 28.0 | 5,000 | 10,000,000 | 72QQ2220(1)02(2) | A72QQ2220(1)02(2) |
| 1,000 | 400 | 0.033 | 13.0 | 28.0 | 5,000 | 10,000,000 | 72QQ2330(1)02(2) | A72QQ2330(1)02(2) |
| 1,000 | 400 | 0.047 | 14.0 | 33.0 | 3,700 | 7,400,000 | 72QT2470(1)02(2) | A72QT2470(1)02(2) |
| 1,000 | 400 | 0.068 | 16.0 | 33.0 | 3,700 | 7,400,000 | 72QT2680(1)02(2) | A72QT2680(1)02(2) |
| 1,000 | 400 | 0.10 | 19.0 | 33.0 | 3,700 | 7,400,000 | 72QT3100(1)02(2) | A72QT3100(1)02(2) |
| 1,500 | 450 | 0.0022 | 8.0 | 20.5 | 17,000 | 51,000,000 | 72SK1220(1)00(2) | A72SK1220(1)00(2) |
| 1,500 | 450 | 0.0033 | 9.5 | 20.5 | 17,000 | 51,000,000 | 72SK1330(1)00(2) | A72SK1330(1)00(2) |
| 1,500 | 450 | 0.0047 | 8.5 | 28.0 | 6,000 | 18,000,000 | 72SQ1470(1)00(2) | A72SQ1470(1)00(2) |
| 1,500 | 450 | 0.0068 | 8.5 | 28.0 | 6,000 | 18,000,000 | 72SQ1680(1)00(2) | A72SQ1680(1)00(2) |
| 1,500 | 450 | 0.010 | 9.5 | 28.0 | 6,000 | 18,000,000 | 72SQ2100(1)00(2) | A72SQ2100(1)00(2) |
| 1,500 | 450 | 0.015 | 11.0 | 28.0 | 6,000 | 18,000,000 | 72SQ2150(1)00(2) | A72SQ2150(1)00(2) |
| 1,500 | 450 | 0.022 | 12.5 | 28.0 | 6,000 | 18,000,000 | 72SQ2220(1)00(2) | A72SQ2220(1)00(2) |
| 1,500 | 450 | 0.033 | 13.5 | 33.0 | 4,500 | 13,500,000 | 72ST2330(1)00(2) | A72ST2330(1)00(2) |
| 1,500 | 450 | 0.047 | 16.0 | 33.0 | 4,500 | 13,500,000 | 72ST2470(1)00(2) | A72ST2470(1)00(2) |
| 1,500 | 450 | 0.068 | 18.0 | 33.0 | 4,500 | 13,500,000 | 72ST2680(1)00(2) | A72ST2680(1)00(2) |
| 2,000 | 500 | 0.0010 | 8.5 | 20.5 | 27,000 | 108,000,000 | 72UK1100(1)00(2) | A72UK1100(1)00(2) |
| 2,000 | 500 | 0.0015 | 9.5 | 20.5 | 27,000 | 108,000,000 | 72UK1150(1)00(2) | A72UK1150(1)00(2) |
| 2,000 | 500 | 0.0022 | 11.0 | 20.5 | 27,000 | 108,000,000 | 72UK1220(1)00(2) | A72UK1220(1)00(2) |
| 2,000 | 500 | 0.0033 | 9.0 | 28.0 | 9,800 | 39,200,000 | 72UQ1330(1)00(2) | A72UQ1330(1)00(2) |
| 2,000 | 500 | 0.0047 | 9.5 | 28.0 | 9,800 | 39,200,000 | 72UQ1470(1)00(2) | A72UQ1470(1)00(2) |
| 2,000 | 500 | 0.0068 | 11.0 | 28.0 | 9,800 | 39,200,000 | 72UQ1680(1)00(2) | A72UQ1680(1)00(2) |
| 2,000 | 500 | 0.010 | 13.0 | 28.0 | 9,800 | 39,200,000 | 72UQ2100(1)00(2) | A72UQ2100(1)00(2) |
| 2,000 | 500 | 0.015 | 13.5 | 33.0 | 7,000 | 28,000,000 | 72UT2150(1)00(2) | A72UT2150(1)00(2) |
| 2,000 | 500 | 0.022 | 16.0 | 33.0 | 7,000 | 28,000,000 | 72UT2220(1)00(2) | A72UT2220(1)00(2) |
| 2,000 | 500 | 0.033 | 20.0 | 33.0 | 7,000 | 28,000,000 | 72UT2330(1)00(2) | A72UT2330(1)00(2) |
| 2,000 | 500 | 0.047 | 22.5 | 33.0 | 7,000 | 28,000,000 | 72UT2470(1)00(2) | A72UT2470(1)00(2) |
| VDC | VAC | Capacitance Value (µF) | B (mm) | H (mm) | dV/dt (V/µs) | Max K ₀ (V ² /µs) | KEMET Internal Part Number | Customer Part Number |

(1) Insert lead and packaging code. See Ordering Options Table for available options.

(2) J = 5%, K = 10%, M = 20%.

Soldering Process

The implementation of the RoHS directive has resulted in the selection of SnAgCu (SAC) alloys or SnCu alloys as primary solder. This has increased the liquidus temperature from that of 183°C for SnPb eutectic alloy to 217 – 221°C for the new alloys. As a result, the heat stress to the components, even in wave soldering, has increased considerably due to higher pre-heat and wave temperatures. Polypropylene capacitors are especially sensitive to heat (the melting point of polypropylene is 160 – 170°C). Wave soldering can be destructive, especially for mechanically small polypropylene capacitors (with lead spacing of 5 mm to 15 mm), and great care has to be taken during soldering. The recommended solder profiles from KEMET should be used. Please consult KEMET with any questions. In general, the wave soldering curve from IEC Publication 61760–1 Edition 2 serves as a solid guideline for successful soldering. Please see Figure 1.

Reflow soldering is not recommended for through-hole film capacitors. Exposing capacitors to a soldering profile in excess of the above recommended limits may result in degradation or permanent damage to the capacitors.

Do not place the polypropylene capacitor through an adhesive curing oven to cure resin for surface mount components. Insert through-hole parts after the curing of surface mount parts. Consult KEMET to discuss the actual temperature profile in the oven, if through-hole components must pass through the adhesive curing process. A maximum two soldering cycles is recommended. Please allow time for the capacitor surface temperature to return to a normal temperature before the second soldering cycle.

Manual Soldering Recommendations

Following is the recommendation for manual soldering with a soldering iron.

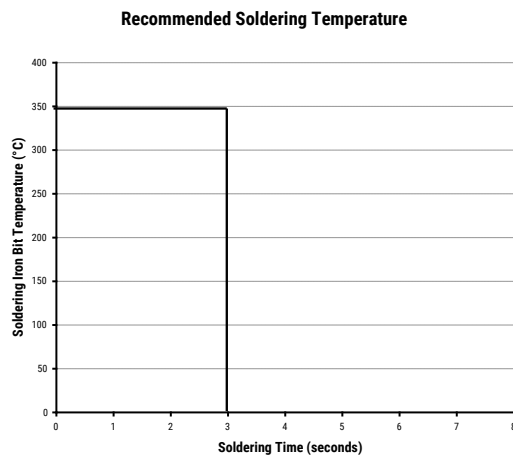

The soldering iron tip temperature should be set at 350°C (+10°C maximum) with the soldering duration not to exceed more than 3 seconds.

Wave Soldering Recommendations

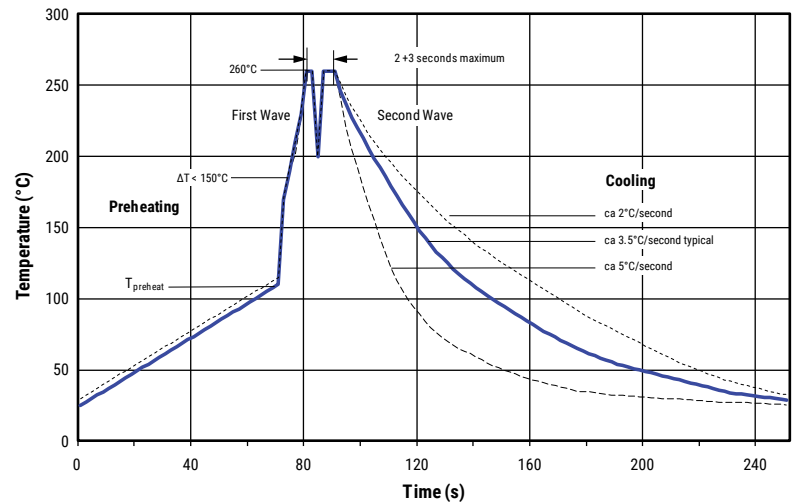

Soldering Process cont.

Wave Soldering Recommendations cont.

1. The table indicates the maximum set-up temperature of the soldering process
 Figure 1

| Dielectric Film Material | Maximum Preheat Temperature | | Maximum Peak Soldering Temperature | |
|--------------------------|-----------------------------|-------------------------|------------------------------------|-------------------------|
| | Capacitor Pitch ≤ 15 mm | Capacitor Pitch > 15 mm | Capacitor Pitch ≤ 15 mm | Capacitor Pitch > 15 mm |
| Polyester | 130°C | 130°C | 270°C | 270°C |
| Polypropylene | 110°C | 130°C | 260°C | 270°C |
| Paper | 130°C | 140°C | 270°C | 270°C |
| Polyphenylene Sulphide | 150°C | 160°C | 270°C | 270°C |

2. The maximum temperature measured inside the capacitor:

Set the temperature so that inside the element the maximum temperature is below the limit:

| Dielectric Film Material | Maximum temperature measured inside the element |
|--------------------------|---|
| Polyester | 160°C |
| Polypropylene | 110°C |
| Paper | 160°C |
| Polyphenylene Sulphide | 160°C |

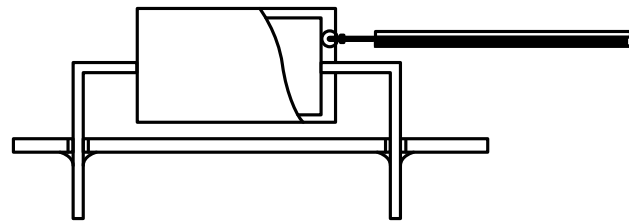

Temperature monitored inside the capacitor.

Selective Soldering Recommendations

Selective dip soldering is a variation of reflow soldering. In this method, the printed circuit board with through-hole components to be soldered is preheated and transported over the solder bath as in normal flow soldering without touching the solder. When the board is over the bath, it is stopped and pre-designed solder pots are lifted from the bath with molten solder only at the places of the selected components, and pressed against the lower surface of the board to solder the components.

The temperature profile for selective soldering is similar to the double wave flow soldering outlined in this document, **however, instead of two baths, there is only one bath with a time from 3 to 10 seconds.** In selective soldering, the risk of overheating is greater than in double wave flow soldering. Great care must be taken so that the parts are not overheated.

Construction

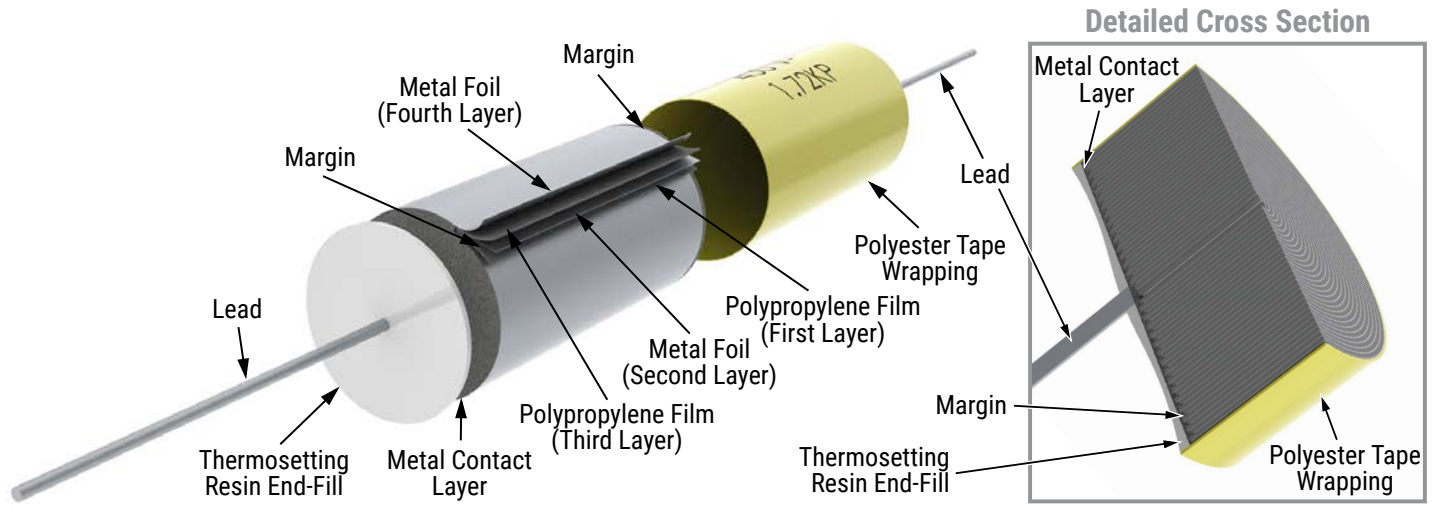

Winding Schemes

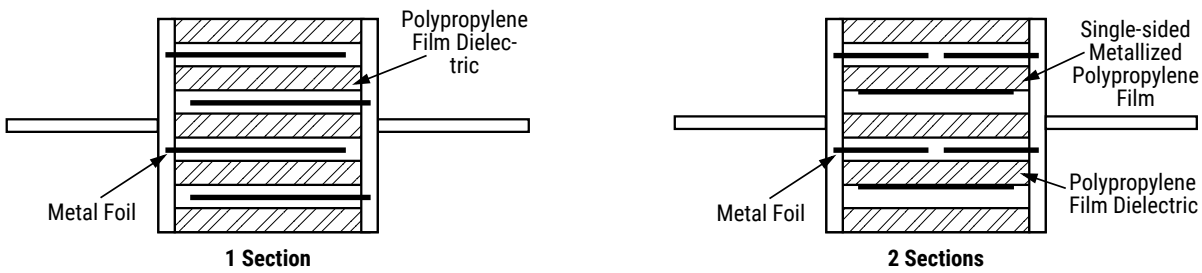

Marking

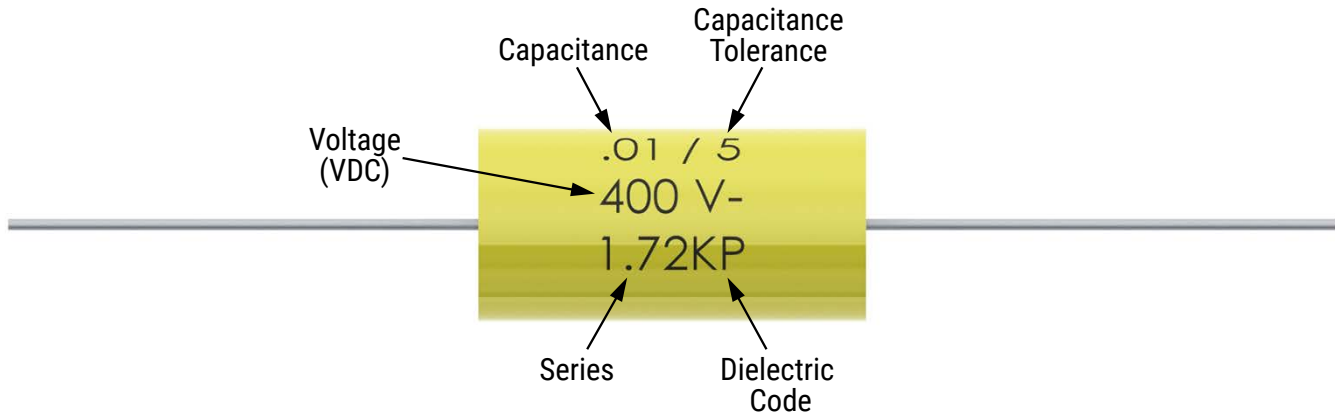

Packaging Quantities

| Diameter | Length | Bulk Long Leads | Standard Reel 355 mm |
|----------|--------|-----------------|----------------------|
| 5.0 | 11.0 | 1,500 | 3,000 |
| 6.5 | 16.5 | 2,000 | 1,200 |
| 7.0 | 16.5 | 1,750 | 1,100 |
| 7.5 | 16.5 | 1,500 | 1,000 |
| 8.0 | 16.5 | 1,250 | 900 |
| 8.0 | 20.5 | 1,000 | 900 |
| 8.0 | 28.0 | 500 | 900 |
| 8.5 | 16.5 | 1,000 | 800 |
| 8.5 | 20.5 | 750 | 800 |
| 8.5 | 28.0 | 500 | 800 |
| 9.0 | 16.5 | 1,000 | 800 |
| 9.0 | 28.0 | 500 | 800 |
| 9.5 | 20.5 | 750 | 600 |
| 9.5 | 28.0 | 500 | 600 |
| 10.0 | 28.0 | 500 | 600 |

| Diameter | Length | Bulk Long Leads | Standard Reel 355 mm |
|----------|--------|-----------------|----------------------|
| 11.0 | 20.5 | 500 | 400 |
| 11.0 | 28.0 | 500 | 400 |
| 11.5 | 28.0 | 300 | 400 |
| 12.5 | 28.0 | 300 | 400 |
| 13.0 | 28.0 | 300 | 400 |
| 13.5 | 28.0 | 300 | 300 |
| 13.5 | 33.0 | 300 | 300 |
| 14.0 | 33.0 | 300 | 300 |
| 16.0 | 33.0 | 200 | 250 |
| 16.5 | 33.0 | 200 | 250 |
| 18.0 | 33.0 | 200 | 200 |
| 19.0 | 33.0 | 150 | 150 |
| 19.5 | 33.0 | 150 | 150 |
| 20.0 | 33.0 | 150 | 150 |
| 22.5 | 33.0 | 100 | - |

Lead Taping & Packaging (IEC 60286-1)

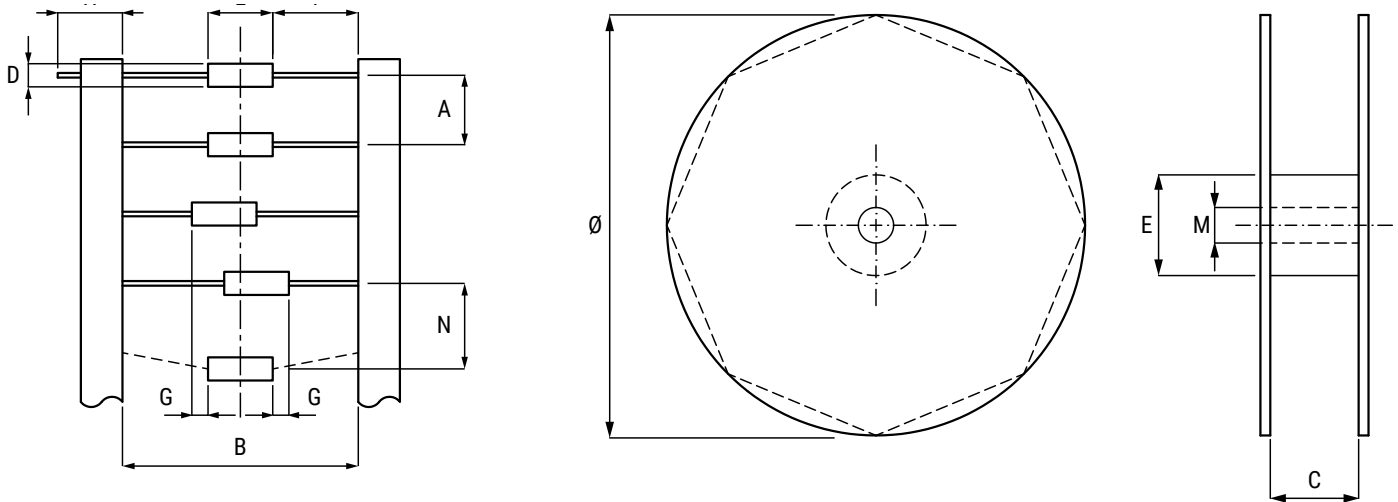

Taping Specification

| Description | Symbol | Dimensions (mm) |
|--|------------------|----------------------------|
| Component diameter | D | 4.5 – 19.5 |
| Body length | L | 11 – 33 |
| Component lead spacing | A ⁽¹⁾ | See Table 1 |
| Reel core diameter | E | 85 |
| Arbor hole diameter | M | 30 |
| Reel diameter | Ø | 355 maximum |
| Tape width | H | 6 ±0.5/9 ±1 ⁽²⁾ |
| Body location (lateral deviation) | G | ≤ 0.7 |
| Body location (longitudinal deviation) | N | ≤ 1.2 |
| Tape spacing | B | See Table 2 |
| Lead length from the component body to the adhesive tape | I | ≥ 20 |
| Distance between reel flanges | C | See Table 2 |

(1) Maximum cumulative feed hole error 1.5 mm per 6 parts.

(2) 9±1 for capacitor with L ≥ 31.5.

Table 1

| Dimensions in mm | |
|------------------|--------|
| Diameter | A |
| ≤ 5 | 5±0.5 |
| 5.1 – 9.5 | 10±0.5 |
| 9.6 – 14.7 | 15±0.5 |
| 14.8 – 19.5 | 20±1.0 |

Table 2

| Dimensions in mm | | | |
|------------------|-------|-------------------|----|
| Length | Class | B ^{±1.5} | C |
| ≤ 11 | I | 52.4 | 75 |
| 14 – 20.5 | II | 63.6 | 86 |
| ≥ 26 | III | 73 | 98 |

KEMET Electronics Corporation Sales Offices

For a complete list of our global sales offices, please visit www.kemet.com/sales.

Disclaimer

All product specifications, statements, information and data (collectively, the "Information") in this datasheet are subject to change. The customer is responsible for checking and verifying the extent to which the Information contained in this publication is applicable to an order at the time the order is placed. All Information given herein is believed to be accurate and reliable, but it is presented without guarantee, warranty, or responsibility of any kind, expressed or implied.

Statements of suitability for certain applications are based on KEMET Electronics Corporation's ("KEMET") knowledge of typical operating conditions for such applications, but are not intended to constitute – and KEMET specifically disclaims – any warranty concerning suitability for a specific customer application or use. The Information is intended for use only by customers who have the requisite experience and capability to determine the correct products for their application. Any technical advice inferred from this Information or otherwise provided by KEMET with reference to the use of KEMET's products is given gratis, and KEMET assumes no obligation or liability for the advice given or results obtained.

Although KEMET designs and manufactures its products to the most stringent quality and safety standards, given the current state of the art, isolated component failures may still occur. Accordingly, customer applications which require a high degree of reliability or safety should employ suitable designs or other safeguards (such as installation of protective circuitry or redundancies) in order to ensure that the failure of an electrical component does not result in a risk of personal injury or property damage.

Although all product-related warnings, cautions and notes must be observed, the customer should not assume that all safety measures are indicated or that other measures may not be required.

KEMET is a registered trademark of KEMET Electronics Corporation.



Компания «ЭлектроПласт» предлагает заключение долгосрочных отношений при поставках импортных электронных компонентов на взаимовыгодных условиях!

Наши преимущества:

- Оперативные поставки широкого спектра электронных компонентов отечественного и импортного производства напрямую от производителей и с крупнейших мировых складов;
- Поставка более 17-ти миллионов наименований электронных компонентов;
- Поставка сложных, дефицитных, либо снятых с производства позиций;
- Оперативные сроки поставки под заказ (от 5 рабочих дней);
- Экспресс доставка в любую точку России;
- Техническая поддержка проекта, помощь в подборе аналогов, поставка прототипов;
- Система менеджмента качества сертифицирована по Международному стандарту ISO 9001;
- Лицензия ФСБ на осуществление работ с использованием сведений, составляющих государственную тайну;
- Поставка специализированных компонентов (Xilinx, Altera, Analog Devices, Intersil, Interpoint, Microsemi, Aeroflex, Peregrine, Syfer, Eurofarad, Texas Instrument, Miteq, Cobham, E2V, MA-COM, Hittite, Mini-Circuits, General Dynamics и др.);

Помимо этого, одним из направлений компании «ЭлектроПласт» является направление «Источники питания». Мы предлагаем Вам помощь Конструкторского отдела:

- Подбор оптимального решения, техническое обоснование при выборе компонента;
- Подбор аналогов;
- Консультации по применению компонента;
- Поставка образцов и прототипов;
- Техническая поддержка проекта;
- Защита от снятия компонента с производства.



Как с нами связаться

Телефон: 8 (812) 309 58 32 (многоканальный)

Факс: 8 (812) 320-02-42

Электронная почта: org@eplast1.ru

Адрес: 198099, г. Санкт-Петербург, ул. Калинина, дом 2, корпус 4, литера А.