

## HiSAT-COT<sup>®</sup> Control 0.5A Inductor Built-in Step-Down “micro DC/DC” Converters

☆Green Operation Compatible

### ■ GENERAL DESCRIPTION

The XCL221/XCL222 series is a synchronous step-down micro DC/DC converter which integrates an inductor and a control IC in one tiny package (2.0mm×2.5mm, h=1.0mm). An internal coil simplifies the circuit and enables minimization of noise and other operational trouble due to the circuit wiring.

A wide operating voltage range of 2.5V to 5.5V enables support for applications that require an internally fixed output voltage (0.8V to 3.6V). The XCL221/XCL222 series uses synchronous rectification at an operating frequency of 1.2MHz. The XCL221/XCL222 series uses HiSAT-COT<sup>(\*)</sup> synchronous rectification. HiSAT-COT+PWM control (XCL221) or HiSAT-COT+automatic PWM/PFM switching control (XCL222) can be selected.

The series have a high speed soft-start as fast as 0.3ms in typical for quick turn-on. With the built-in UVLO function, the internal P-channel driver transistor is forced OFF when input voltage becomes 2.0V or lower. When CE=Low, the integrated C<sub>L</sub> discharge function which enables the electric charge at the output capacitor C<sub>L</sub> to be discharged via the internal discharge switch located between the L<sub>X</sub> and PGND pins. The power consumption will be less than 1.0μA.

(\*) HiSAT-COT is a proprietary high-speed transient response technology for DC/DC converter which was developed by Torex.

It is Ideal for the LSI's that require high precision and high stability power supply voltage.

### ■ APPLICATIONS

- Wearable Device
- Bluetooth Module
- SSD(Solid State Drive)
- Mobile phone
- Digital still camera
- Portable game devices

### ■ FEATURES

Input Voltage	: 2.5V ~ 5.5V
Output Voltage	: 0.8V ~ 3.6V (±2.0%)
Oscillation Frequency	: 1.2MHz
Output Current	: 500mA
Efficiency	: 93% (V <sub>IN</sub> =5.0V, V <sub>OUT</sub> =3.3V/200mA)
Control Methods	: HiSAT-COT 100% Duty Cycle PWM (XCL221) PWM/PFM (XCL222)
Circuit Protection	: Thermal Shut Down Current Limit Circuit (Drop) Short Circuit Protection (Latch)
Functions	: Soft-start Circuit Built-in UVLO C <sub>L</sub> Discharge
Output Capacitor	: Low ESR Ceramic Capacitor
Operating Ambient Temperature	: -40°C ~ 105°C
Package	: CL-2025-02
Environmental Friendly	: EU RoHS Compliant, Pb Free

### ■ TYPICAL APPLICATION CIRCUIT



### ■ TYPICAL PERFORMANCE CHARACTERISTICS

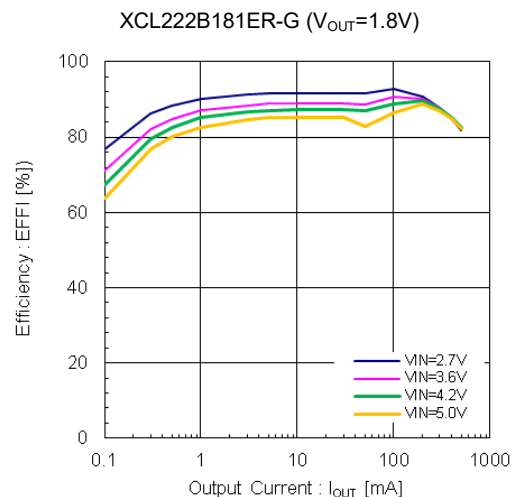

# XCL221/XCL222 Series

## ■ BLOCK DIAGRAM

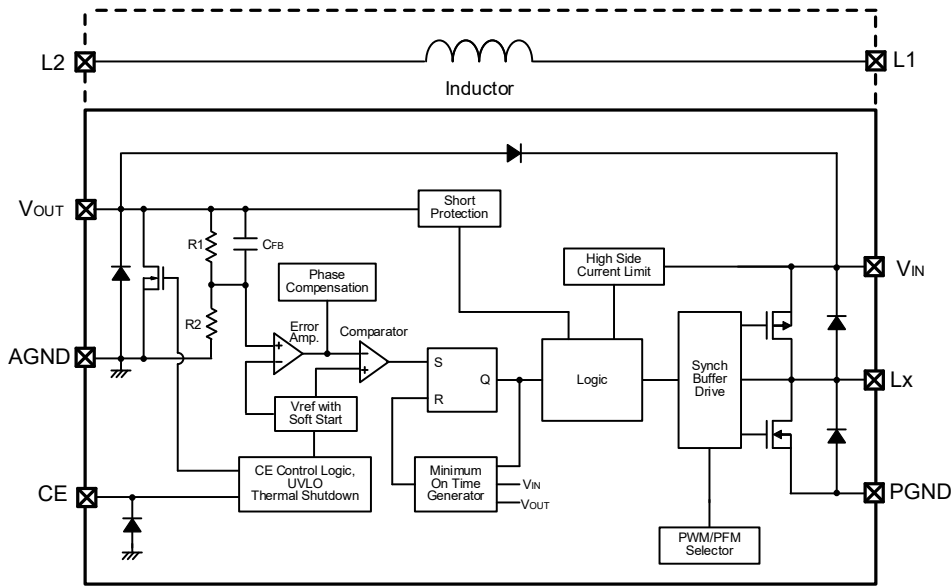

\* The XCL221 offers a fixed PWM control, a Control Logic of PWM/PFM Selector is fixed at "PWM" internally.  
 The XCL222 control scheme is a fixed PWM/PFM automatic switching, a Control Logic of PWM/PFM Selector is fixed at "PWM/PFM automatic switching" internally.  
 Diodes inside the circuit are an ESD protection diode and a parasitic diode.

## ■ PRODUCT CLASSIFICATION

### ● Ordering Information

XCL221①②③④⑤⑥-⑦ PWM

XCL222①②③④⑤⑥-⑦ PWM/PFM Automatic switching control

DESIGNATOR	ITEM	SYMBOL	DESCRIPTION
①	Type	B	Refer to Selection Guide
②③	Output Voltage	08 ~ 36	Output Voltage options e.g.)1.2V → ②=1, ③=2 1.25V → ②=1, ③=C 0.05V Increments: 0.05=A,0.15=B,0.25=C,0.35=D,0.45=E,0.55=F,0.65=H, 0.75=K,0.85=L,0.95=M
④	Oscillation Frequency	1	1.2MHz
⑤⑥-⑦ <sup>(*)</sup>	Package (Order Unit)	ER-G	CL-2025-02 (3,000pcs/Reel)

<sup>(\*)</sup> The "-G" suffix denotes Halogen and Antimony free as well as being fully EU RoHS compliant.

### ● Selection Guide

TYPE	OUTPUT VOLTAGE	C <sub>L</sub> AUTO-DISCHARGE	LATCH or SHORT PROTECTION	UVLO	CHIP ENABLE	CURRENT LIMIT	SOFT-START	THERMAL SHUTDOWN
B	Fixed	Yes	Yes	Yes	Yes	Yes	Fixed	Yes

## ■ PIN CONFIGURATION



CL-2025-02  
(BOTTOM VIEW)

- \* It should be connected the pin No.2 and 5 to the GND pin.
- \* If the dissipation pad needs to be connected to other pins, it should be connected to the GND pin.
- \* Please refer to pattern layout page for the connecting to PCB.

## ■ PIN ASSIGNMENT

PIN NUMBER	PIN NAME	FUNCTIONS
1	Lx	Switching Output
2	AGND	Analog Ground
3	V <sub>OUT</sub>	Fixed Output Voltage PIN
4	CE	Chip Enable
5	PGND	Power Ground
6	V <sub>IN</sub>	Power Input
7	L1	Inductor Electrodes
8	L2	Inductor Electrodes

## ■ FUNCTION TABLE

PIN NAME	SIGNAL	STATUS
CE	Low	Stand-by
	High	Active

\* Please do not leave the CE pin open.

## ■ ABSOLUTE MAXIMUM RATINGS

PARAMETER	SYMBOL	RATINGS	UNITS
V <sub>IN</sub> Pin Voltage	V <sub>IN</sub>	-0.3 ~ 6.2	V
L <sub>X</sub> Pin Voltage	V <sub>Lx</sub>	-0.3 ~ V <sub>IN</sub> + 0.3 or 6.2 <sup>(*)1</sup>	V
V <sub>OUT</sub> Pin Voltage	V <sub>out</sub>	-0.3 ~ V <sub>IN</sub> + 0.3 or 4.0 <sup>(*)2</sup>	V
CE Pin Voltage	V <sub>CE</sub>	-0.3 ~ 6.2	V
Power Dissipation (T <sub>a</sub> =25°C)	P <sub>d</sub>	1000 (40mm x 40mm Standard board ) <sup>(*)3</sup>	mW
Operating Ambient Temperature	T <sub>opr</sub>	-40 ~ 105	°C
Storage Temperature	T <sub>stg</sub>	-55 ~ 125	°C

All voltages are described based on the GND (AGND and PGND) pin.

<sup>(\*)1</sup> The maximum value should be either V<sub>IN</sub>+0.3V or +6.2V in the lowest voltage

<sup>(\*)2</sup> The maximum value should be either V<sub>IN</sub>+0.3V or +4.0V in the lowest voltage

<sup>(\*)3</sup> The power dissipation figure shown is PCB mounted and is for reference only.

The mounting condition is please refer to PACKAGING INFORMATION.

## ELECTRICAL CHARACTERISTICS

● XCL221Bxx1ER-G/XCL222Bxx1ER-G

Ta=25°C

PARAMETER	SYMBOL	CONDITIONS	MIN.	TYP.	MAX.	UNITS	CIRCUIT
Output Voltage	V <sub>OUT</sub>	When connected to external components, I <sub>OUT</sub> =30mA	<E-1>	<E-2>	<E-3>	V	①
Operating Voltage Range	V <sub>IN</sub>		2.5	-	5.5	V	①
Maximum Output Current	I <sub>OUTMAX</sub>	When connected to external components, V <sub>IN</sub> =<C-1>	500	-	-	mA	①
UVLO Voltage <sup>(2)</sup>	V <sub>UVLO</sub>	V <sub>out</sub> =0.6V, Voltage which Lx pin holding "L" level <sup>(6)</sup>	1.35	2.0	2.48	V	③
Quiescent Current (XCL222)	I <sub>q</sub>	V <sub>OUT</sub> =V <sub>OUT(E)</sub> × 1.1	-	15	25	μA	②
Quiescent Current (XCL221)	I <sub>q</sub>	V <sub>OUT</sub> =V <sub>OUT(E)</sub> × 1.1	-	250	450	μA	②
Stand-by Current	I <sub>STB</sub>	V <sub>CE</sub> =0V	-	0.0	1.0	μA	②
Minimum ON time <sup>(2)</sup>	t <sub>ONmin</sub>	When connected to external components, V <sub>IN</sub> =V <sub>CE</sub> =<C-1>, I <sub>OUT</sub> =1mA	<E-5>	<E-6>	<E-7>	ns	①
Thermal Shutdown	T <sub>TSD</sub>		-	150	-	°C	①
Thermal shutdown Hysteresis	T <sub>HYS</sub>		-	30	-	°C	①
LxSW "H" ON Resistance	R <sub>LXH</sub>	V <sub>OUT</sub> =0.6V, I <sub>LX</sub> =100mA <sup>(3)</sup>	-	0.24	0.37	Ω	④
LxSW "L" ON Resistance <sup>(4)</sup>	R <sub>LXL</sub>	V <sub>OUT</sub> =V <sub>OUT(T)</sub> × 1.1, I <sub>LX</sub> =100mA <sup>(3)</sup>	-	0.16	0.30	Ω	④
LxSW "H" Leakage Current	I <sub>LeakH</sub>	V <sub>IN</sub> =5.5V, V <sub>CE</sub> =0V, V <sub>OUT</sub> =0V, V <sub>LX</sub> =5.5V	-	0.0	30.0	μA	⑤
LxSW "L" Leakage Current	I <sub>LeakL</sub>	V <sub>IN</sub> =5.5V, V <sub>CE</sub> =0V, V <sub>OUT</sub> =0V, V <sub>LX</sub> =0V	-	0.0	1.0	μA	⑤
Current Limit <sup>(5)</sup>	I <sub>LIMH</sub>	V <sub>OUT</sub> =0.6V, I <sub>LX</sub> until Lx pin oscillates	1.3	1.5	2.5	A	⑥
Output Voltage Temperature Characteristics	ΔV <sub>OUT</sub> / (V <sub>OUT</sub> ·Δtopr)	I <sub>OUT</sub> =30mA -40°C ≤ Topr ≤ 105°C	-	±100	-	ppm/°C	①
CE "H" Voltage	V <sub>CEH</sub>	V <sub>OUT</sub> =0.6V, Applied voltage to V <sub>CE</sub> , Voltage changes Lx to "H" level <sup>(6)</sup>	1.4	-	5.5	V	③
CE "L" Voltage	V <sub>CEL</sub>	V <sub>FB</sub> =0.6V, Applied voltage to V <sub>CE</sub> , Voltage changes Lx to "L" level <sup>(6)</sup>	AGND	-	0.3	V	③
CE "H" Current	I <sub>CEH</sub>	V <sub>IN</sub> =5.5V, V <sub>CE</sub> =5.5V, V <sub>OUT</sub> =0V	-0.1	-	0.1	μA	⑤
CE "L" Current	I <sub>CEL</sub>	V <sub>IN</sub> =5.5V, V <sub>CE</sub> =0V, V <sub>OUT</sub> =0V	-0.1	-	0.1	μA	⑤
Soft-start Time	t <sub>SS</sub>	V <sub>CE</sub> =0V→5.0V, V <sub>OUT</sub> =V <sub>OUT(T)</sub> × 0.9 After "H" is fed to CE, the time by which when clocks are generated at Lx pin.	0.10	0.30	0.50	ms	③
Short Protection Threshold Voltage	V <sub>SHORT</sub>	Sweeping V <sub>OUT</sub> , V <sub>OUT</sub> voltage which Lx becomes "L" level <sup>(6)</sup>	0.17	0.27	0.37	V	③
C <sub>L</sub> Discharge	R <sub>DCHG</sub>	V <sub>CE</sub> =0V, V <sub>OUT</sub> =4.0V	50	210	300	Ω	⑦
Inductance	L	Test Freq.=1MHz	-	4.7	-	μH	-
Inductor Rated Current	I <sub>DC</sub>	ΔT=+40deg	-	700	-	mA	-

Unless otherwise stated, V<sub>IN</sub>=5.0V, V<sub>CE</sub>=5.0V, V<sub>OUT(T)</sub>=Nominal Voltage

NOTE:

<sup>(1)</sup> When the difference between the input and the output is small, 100% duty might come up and internal control circuits keep P-ch driver turning on even though the output current is not so large.

If current is further pulled from this state, output voltage will decrease because of P-ch driver ON resistance.

<sup>(2)</sup> Including UVLO detect voltage, hysteresis operating voltage range for UVLO release voltage.

<sup>(3)</sup> R<sub>LXH</sub>=(V<sub>IN</sub> - Lx pin measurement voltage) / 100mA, R<sub>LXL</sub>=Lx pin measurement voltage / 100mA

<sup>(4)</sup> Design value for the XCL222 series

<sup>(5)</sup> Current limit denotes the level of detection at peak of coil current.

<sup>(6)</sup> "H"=V<sub>IN</sub> ~ V<sub>IN</sub> - 1.2V, "L"=- 0.1V ~ + 0.1V

## ■ ELECTRICAL CHARACTERISTICS (Continued)

● SPEC Table ( $V_{OUT}$ ,  $t_{ONmin}$ )

NOMINAL OUTPUT VOLTAGE	$V_{OUT}$			$t_{ONmin}$				NOMINAL OUTPUT VOLTAGE	$V_{OUT}$			$t_{ONmin}$			
	<E-1>	<E-2>	<E-3>	<C-1>	$f_{osc}=1.2MHz$				<E-1>	<E-2>	<E-3>	<C-1>	$f_{osc}=1.2MHz$		
	$V_{OUT(T)}$	MIN.	TYP.	MAX.	$V_{IN}$	MIN.	TYP.		MAX.	$V_{OUT(T)}$	MIN.	TYP.	MAX.	$V_{IN}$	MIN.
0.80	0.784	0.800	0.816	2.50	187	267	347	2.25	2.205	2.250	2.295	3.75	350	500	650
0.85	0.833	0.850	0.867	2.50	198	283	368	2.30	2.254	2.300	2.346	3.83	350	500	650
0.90	0.882	0.900	0.918	2.50	210	300	390	2.35	2.303	2.350	2.397	3.92	350	500	650
0.95	0.931	0.950	0.969	2.50	222	317	412	2.40	2.352	2.400	2.448	4.00	350	500	650
1.00	0.980	1.000	1.020	2.50	233	333	433	2.45	2.401	2.450	2.499	4.08	350	500	650
1.05	1.029	1.050	1.071	2.50	245	350	455	2.50	2.450	2.500	2.550	4.17	350	500	650
1.10	1.078	1.100	1.122	2.50	257	367	477	2.55	2.499	2.550	2.601	4.25	350	500	650
1.15	1.127	1.150	1.173	2.50	268	383	498	2.60	2.548	2.600	2.652	4.33	350	500	650
1.20	1.176	1.200	1.224	2.50	280	400	520	2.65	2.597	2.650	2.703	4.42	350	500	650
1.25	1.225	1.250	1.275	2.50	292	417	542	2.70	2.646	2.700	2.754	4.50	350	500	650
1.30	1.274	1.300	1.326	2.50	303	433	563	2.75	2.695	2.750	2.805	4.58	350	500	650
1.35	1.323	1.350	1.377	2.50	315	450	585	2.80	2.744	2.800	2.856	4.67	350	500	650
1.40	1.372	1.400	1.428	2.50	327	467	607	2.85	2.793	2.850	2.907	4.75	350	500	650
1.45	1.421	1.450	1.479	2.50	338	483	628	2.90	2.842	2.900	2.958	4.83	350	500	650
1.50	1.470	1.500	1.530	2.50	350	500	650	2.95	2.891	2.950	3.009	4.92	350	500	650
1.55	1.519	1.550	1.581	2.58	350	500	650	3.00	2.940	3.000	3.060	5.00	350	500	650
1.60	1.568	1.600	1.632	2.67	350	500	650	3.05	2.989	3.050	3.111	5.08	350	500	650
1.65	1.617	1.650	1.683	2.75	350	500	650	3.10	3.038	3.100	3.162	5.17	350	500	650
1.70	1.666	1.700	1.734	2.83	350	500	650	3.15	3.087	3.150	3.213	5.25	350	500	650
1.75	1.715	1.750	1.785	2.92	350	500	650	3.20	3.136	3.200	3.264	5.33	350	500	650
1.80	1.764	1.800	1.836	3.00	350	500	650	3.25	3.185	3.250	3.315	5.42	350	500	650
1.85	1.813	1.850	1.887	3.08	350	500	650	3.30	3.234	3.300	3.366	5.50	350	500	650
1.90	1.862	1.900	1.938	3.17	350	500	650	3.35	3.283	3.350	3.417	5.50	355	508	660
1.95	1.911	1.950	1.989	3.25	350	500	650	3.40	3.332	3.400	3.468	5.50	361	515	670
2.00	1.960	2.000	2.040	3.33	350	500	650	3.45	3.381	3.450	3.519	5.50	366	523	680
2.05	2.009	2.050	2.091	3.42	350	500	650	3.50	3.430	3.500	3.570	5.50	371	530	689
2.10	2.058	2.100	2.142	3.50	350	500	650	3.55	3.479	3.550	3.621	5.50	377	538	699
2.15	2.107	2.150	2.193	3.58	350	500	650	3.60	3.528	3.600	3.672	5.50	382	545	709
2.20	2.156	2.200	2.244	3.67	350	500	650								

## ■ TYPICAL CIRCUIT



	VALUE	PRODUCT NUMBER
$C_{IN}$	10V/4.7µF	LMK105BBJ475MVLFF (Taiyo Yuden)
		LMK107BJ475KA (Taiyo Yuden)
		C1608X5R1A475K (TDK)
		C2012X7R1A475M (TDK)
$C_L$	10V/10µF (*1)	LMK105CBJ106MVLFF (Taiyo Yuden)
		LMK107BBJ106MALT (Taiyo Yuden)
		C1608X5R1A106K (TDK)
		C2012X7R1A106M (TDK)

(\*1) Use  $C_L = 20\mu F$  or more when  $V_{IN} - V_{OUT(T)} < 1.5V$ .

**NOTE:**

The integrated Inductor can be used only for this DC/DC converter. Please do not use this inductor for other reasons.

# XCL221/XCL222 Series

## TEST CIRCUITS

< Circuit No.① >



※External Components  
 L: 4.7  $\mu$  H (Selected goods)  
 CIN: 10  $\mu$  F (Ceramic)  
 CL: 10  $\mu$  F (Ceramic)

< Circuit No.② >



< Circuit No.③ >



< Circuit No.④ >



< Circuit No.⑤ >

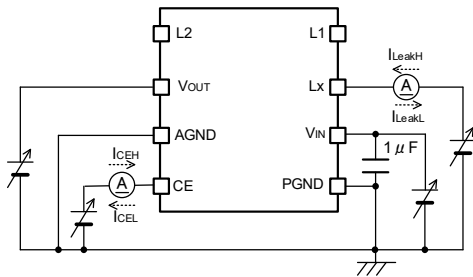

< Circuit No.⑥ >

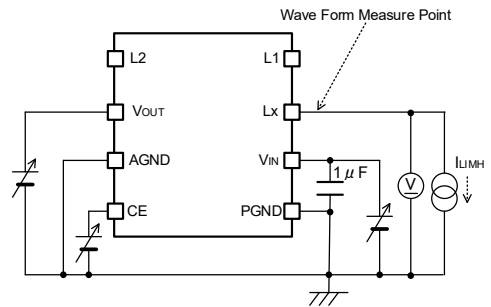

< Circuit No.⑦ >

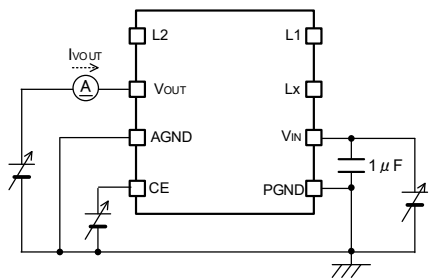

## ■ OPERATIONAL EXPLANATION

The XCL221/XCL222 series consists of a reference voltage source, error amplifier, comparator, phase compensation, minimum on time generation circuit, output voltage adjustment resistors, P-channel MOS driver transistor, N-channel MOS switching transistor for the synchronous switch, current limiter circuit, UVLO circuit, thermal shutdown circuit, short protection circuit, PWM/PFM selection circuit and others.

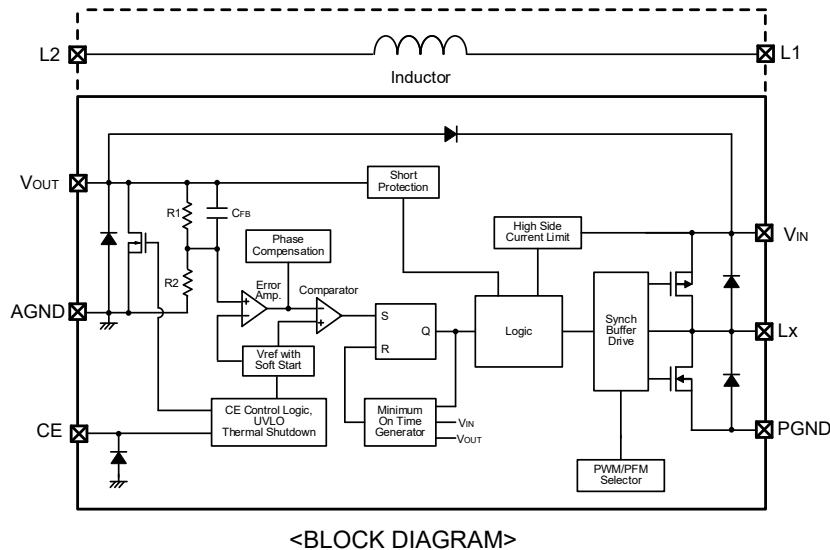

The method is HiSAT-COT (High Speed circuit Architecture for Transient with Constant On Time) control, which features on time control method and a fast transient response that also achieves low output voltage ripple. The on time ( $t_{on}$ ) is determined by the input voltage and output voltage, and turns on the Pch MOS driver Tr. for a fixed time. During the off time ( $t_{off}$ ), the voltage that is fed back through R1 and R2 is compared to the reference voltage by the error amp, and the error amp output is phase compensated and sent to the comparator. The comparator compares this signal to the reference voltage, and if the signal is lower than the reference voltage, sets the SR latch. On time then resumes. By doing this, PWM operation takes place with the off time controlled to the optimum duty ratio and the output voltage is stabilized. The phase compensation circuit optimizes the frequency characteristics of the error amp, and generates a ramp wave similar to the ripple voltage that occurs in the output to modulate the output signal of the error amp. This enables a stable feedback system to be obtained even when a low ESR capacitor such as a ceramic capacitor is used, and a fast transient response and stabilization of the output voltage are achieved.

### <Minimum on time generation circuit>

Generates an on time that depends on the input voltage and output voltage ( $t_{on}$ ). The on time is set as given by the equations below.

$$f_{osc} = 1.2 \text{ MHz}$$

$$t_{on} (\mu s) = V_{OUT} / V_{IN} \times 0.833$$

### <Switching frequency>

The switching frequency can be obtained from the on time ( $t_{on}$ ), which is determined by the input voltage and output voltage, as given by the equation below.

$$f_{osc} (\text{MHz}) = V_{OUT} (\text{V}) / (V_{IN} (\text{V}) \times t_{on} (\mu s))$$

### <100% duty cycle mode>

When the load current is heavy and the voltage difference between input voltage and output voltage is small, 100% duty cycle mode is activated and it keeps the Pch MOS driver Tr. turning on. 100% duty cycle mode attains a high output voltage stability and a high-speed response under all load conditions, from light to heavy, even in conditions where the dropout voltage is low.

### <Error amp>

The error amp monitors the output voltage. The voltage divided by the internal R1 and R2 resistors is a feedback voltage for Error Amp. and compared to the reference voltage. The output voltage of the error amp becomes higher when the feedback voltage is higher than the reference voltage. The frequency characteristics of the error amp are optimized internally.

## OPERATIONAL EXPLANATION (Continued)

### <Reference voltage source, soft-start function>

The reference voltage forms a reference that is used to stabilize the output voltage of the IC. After chip enable of the IC, the reference voltage connected to the error amp increases linearly during the soft-start interval.

This allows the voltage divided by the internal R1 and R2 resistors and the reference voltage to be controlled in a balanced manner, and the output voltage rises in proportion to the rise in the reference voltage. This operation prevents rush input current and enables the output voltage to rise smoothly.

If the output voltage does not reach the set output voltage within the soft start time, such as when the load is heavy or a large capacity output capacitor is connected, the balancing of the voltage divided by the internal resistors R1 and R2 and the reference voltage is lost, however, the current restriction function activates to prevent an excessive increase of input current, enabling a smooth rise of the output voltage.

### <PWM/PFM selection circuit>

PWM control is a continuous conduction mode, and operates at a stable switching frequency by means of an on time ( $t_{on}$ ) that is determined by the input voltage and output voltage regardless of the load.

PWM/PFM auto switching control is a discontinuous conduction mode at light loads, and lowers the switching frequency to reduce switching loss and improve efficiency.

The XCL221 series is internally fixed to PWM control.

The XCL222 series is internally fixed to PWM/PFM auto switching control.

### <CE function>

Operation starts when "H" voltage is input into the CE pin. The IC can be put in the shutdown state by inputting "L" voltage into the CE pin. In the shutdown state, the supply current of the IC is  $0\mu\text{A}$  (TYP.), and the Pch MOS driver Tr. and Nch MOS switch Tr. for synchronous rectification turn off. The CE pin is a CMOS input and the sink current is  $0\mu\text{A}$ .

### <UVLO>

When the  $V_{IN}$  voltage becomes 2.00V (TYP.) or lower, the P-ch MOS driver transistor output driver transistor is forced OFF to prevent false pulse output caused by unstable operation of the internal circuitry. When the  $V_{IN}$  pin voltage becomes 2.10V (TYP.) or higher, switching operation takes place. By releasing the UVLO function, the IC performs the soft start function to initiate output startup operation. The UVLO circuit does not cause a complete shutdown of the IC, but causes pulse output to be suspended; therefore, the internal circuitry remains in operation.

### <Thermal Shutdown>

For protection against heat damage of the ICs, thermal shutdown function monitors chip temperature. The thermal shutdown circuit starts operating and the P-ch MOS driver and N-ch MOS driver transistor will be turned off when the chip's temperature reaches  $150^{\circ}\text{C}$ . When the temperature drops to  $120^{\circ}\text{C}$  (TYP.) or less after shutting of the current flow, the IC performs the soft-start function to initiate output startup operation.

### <Short-circuit protection function>

The short-circuit protection circuit protects the device that is connected to this product and to the input/output in situations such as when the output is accidentally shorted to GND. The short-circuit protection circuit monitors the output voltage, and when the output voltage falls below the short-circuit protection threshold voltage, it turns off the Pch MOS driver Tr and latches it. Once in the latched state, operation is resumed by turning off the IC from the CE pin and then restarting, or by re-input into the  $V_{IN}$  pin.



## ■ OPERATIONAL EXPLANATION (Continued)

### <CL High Speed Discharge>

The product can quickly discharge the electric charge at the output capacitor (CL) when a low signal to the CE pin which enables a whole IC circuit put into OFF state, is inputted via the N-ch MOS switch transistor located between the VOUT pin and the GND pin. When the IC is disabled, electric charge at the output capacitor (CL) is quickly discharged so that it may avoid application malfunction

$$V = V_{OUT(T)} \times e^{-t / \tau}$$

$$t = \tau \ln (V_{OUT(T)} / V)$$

V : Output voltage after discharge

V<sub>OUT(T)</sub> : Output voltage

t : Discharge time

$$\tau : C_L \times R_{DCHG}$$

C<sub>L</sub> : Capacitance of Output capacitor

R<sub>DCHG</sub> : C<sub>L</sub> auto-discharge resistance, but it depends on supply voltage.

Output Voltage Discharge characteristics  
R<sub>DCHG</sub>=210Ω (TYP.) C<sub>L</sub>=10μF



### <Current Limit>

The current limiter circuit of the XCL221/XCL222 series monitors the current flowing through the P-channel MOS driver transistor connected to the Lx pin. When the driver current is greater than a specific level, the current limit function operates to turn off the pulses from the Lx pin at any given timing. When the over current state is eliminated, the IC resumes its normal operation.

## ■ NOTE ON USE

1. For the phenomenon of temporal and transitional voltage decrease or voltage increase, the IC may be damaged or deteriorated if IC is used beyond the absolute MAX. specifications.
2. Spike noise and ripple voltage arise in a switching regulator as with a DC/DC converter. These are greatly influenced by external component selection, such as the coil inductance, capacitance values, and board layout of external components. Once the design has been completed, verification with actual components should be done.
3. The DC/DC converter characteristics depend greatly on the externally connected components as well as on the characteristics of this IC, so refer to the specifications and standard circuit examples of each component when carefully considering which components to select. Be especially careful of the capacitor characteristics and use B characteristics (JIS standard) or X7R, X5R (EIA standard) ceramic capacitors.
4. Sufficiently reinforce the ground wiring. In particular, reinforce near the PGND and AGND pin as fluctuations of the ground phase due to the ground current during switching may cause the operation of the IC to become unstable.
5. Mount external components as close as possible to the IC. Keep the wiring short and thick to lower the wiring impedance.
6. A feature of HiSAT-COT control is that it controls the off time in order to control the duty, which varies due to the effects of power loss between the input (V<sub>IN</sub> pin) and output (V<sub>OUT</sub> pin) due to the load, and thus the switching frequency fluctuates. In addition, changes in the on time due to 100% duty cycle mode are allowed. For this reason, caution must be exercised as the characteristics of the switching frequency will vary depending on the external component characteristics, board layout, input voltage, output voltage, load current and other parameters.
7. Due to propagation delay inside the product, the on time generated by the minimum on time generation circuit may not be the same as the on time that is the ratio of the input voltage to the output voltage.
8. With regard to the current limiting value, the actual coil current may at times exceed the electrical characteristics due to propagation delay inside the product.

## NOTE ON USE(Continued)

9. The CE pin is a CMOS input pin. Do not use with the pin open. If connecting to the input or ground, use a resistor up to 1MΩ. To prevent malfunctioning of the device connected to this product or the input/output due to short circuiting between pins, it is recommended that a resistor be connected.
10. If the output voltage drops below the short circuit protection threshold voltage at the end of the soft start interval, operation will stop.
11. PWM/PFM auto switching control is a discontinuous conduction mode when the load is light, and in cases where the voltage difference between input and output is low or the coil inductance is higher than the value indicated in the standard circuit example, the coil current may reverse when the load is light, and thus pulse skipping will not be possible and light load efficiency will worsen.
12. When the input voltage is close to the minimum input voltage, the current limit circuit might not be able to work.
13. When the voltage difference between input voltage and output voltage is low, the load stability feature may deteriorate.
14. If the capacitance value is not sufficient by degrading C<sub>L</sub> due to the low temp. condition and DC bias feature, 100% duty cycle might come up for the load transient condition. Add capacitance value for C<sub>L</sub> if necessary.
15. If the capacitance value is not sufficient by degrading C<sub>L</sub> due to the low temp. condition and DC bias feature, the duty cycle might not be stable. Add capacitance value for C<sub>L</sub> if necessary.
16. Torex places an importance on improving our products and their reliability. We request that users incorporate fail-safe designs and post-aging protection treatment when using Torex products in their systems.
17. The proper position of mounting is based on the coil terminal
18. Please use within the power dissipation range below. Please also note that the power dissipation may be changed by test conditions, the power dissipation figure shown is PCB mounted.

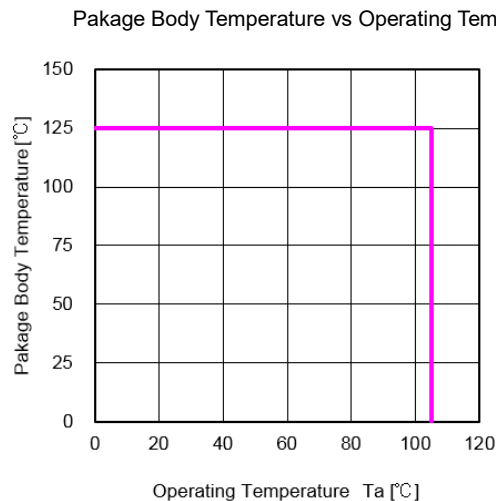

the power loss of micro DC/DC according to the following formula:

$$\text{power loss} = V_{\text{OUT}} \times I_{\text{OUT}} \times ((100/\text{EFFI}) - 1) \quad (\text{W})$$

V<sub>OUT</sub> : Output Voltage (V)

I<sub>OUT</sub> : Output Current (A)

EFFI : Conversion Efficiency (%)

## ■ NOTE ON USE (Continued)

### 19. Instructions of pattern layouts

The operation may become unstable due to noise and/or phase lag from the output current when the wire impedance is high, please place the input capacitor( $C_{IN}$ ) and the output capacitor ( $C_L$ ) as close to the IC as possible.

- (1) In order to stabilize  $V_{IN}$  voltage level, we recommend that a by-pass capacitor ( $C_{IN}$ ) be connected as close as possible to the  $V_{IN}$  pin, PGND pin.
- (2) Please mount each external component as close to the IC as possible.
- (3) Wire external components as close to the IC as possible and use thick, short connecting traces to reduce the circuit impedance.
- (4) Make sure that the GND traces are as thick as possible, as variations in ground potential caused by high ground currents at the time of switching may result in instability of the IC.
- (5) This series' internal driver transistors bring on heat because of the output current and ON resistance of P-channel and N-channel MOS driver transistors. Please consider the countermeasures against heat if necessary.
- (6) As precautions on mounting, please set the mounting position accuracy within 0.05 mm.

<Reference pattern layout>



<Top View>



<Back Side Top View>

## TYPICAL PERFORMANCE CHARACTERISTICS

(1) Output Voltage vs. Output Current

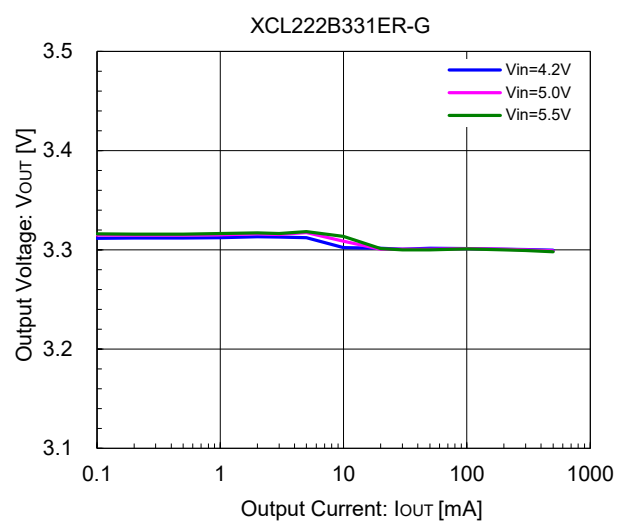
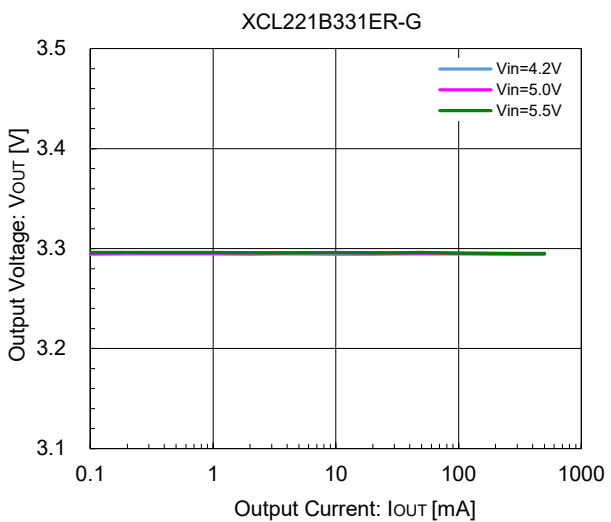
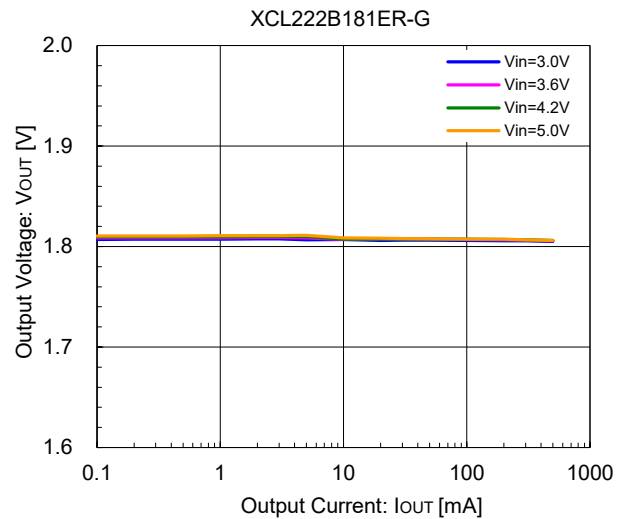
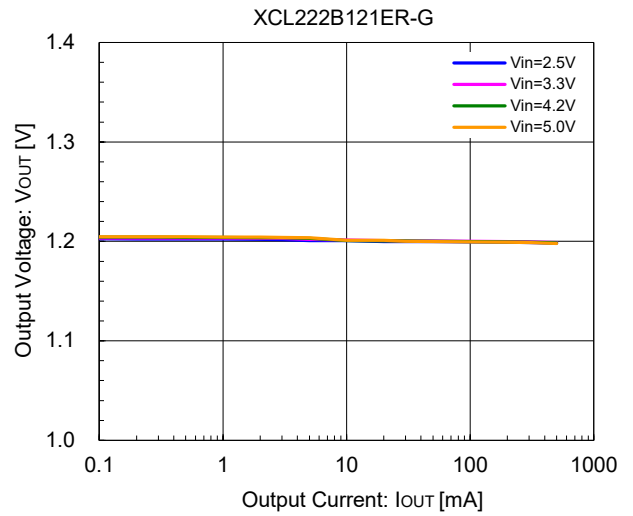

## ■ TYPICAL PERFORMANCE CHARACTERISTICS(Continued)

(2) Efficiency vs. Output Current

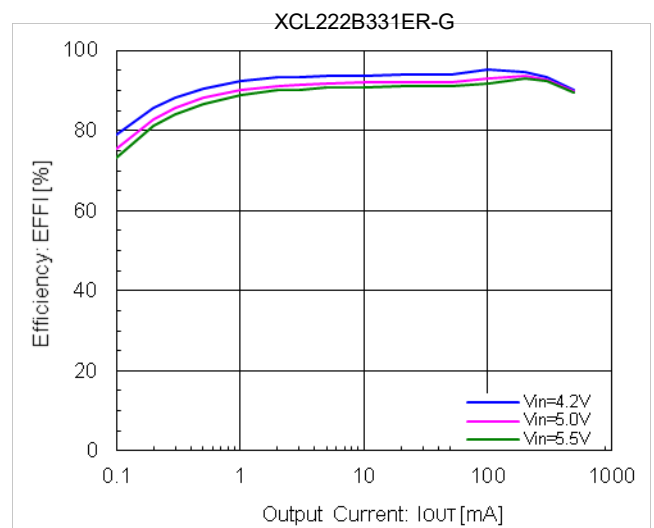
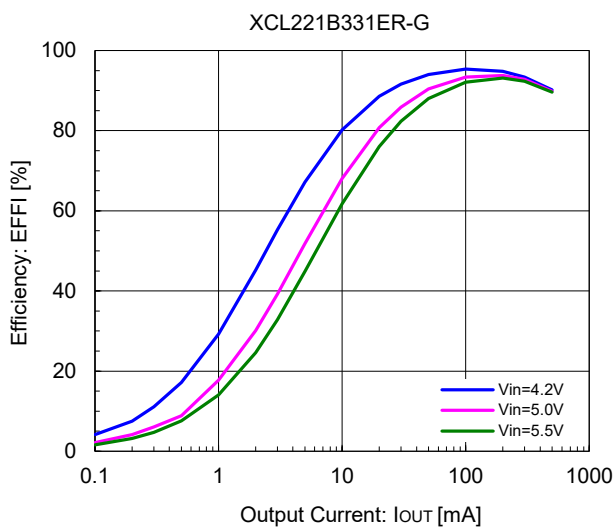
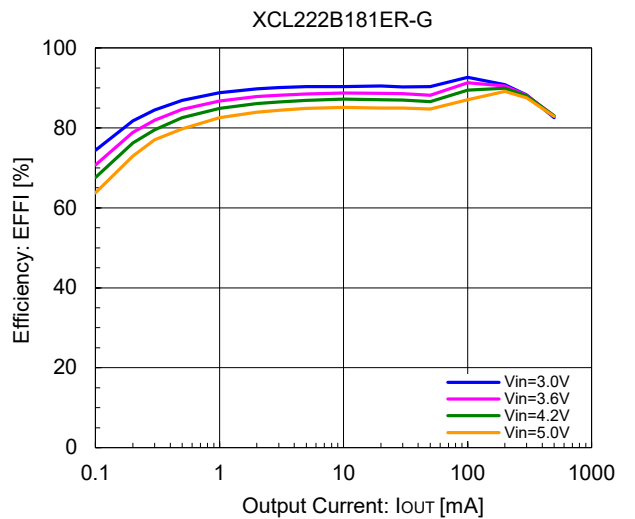
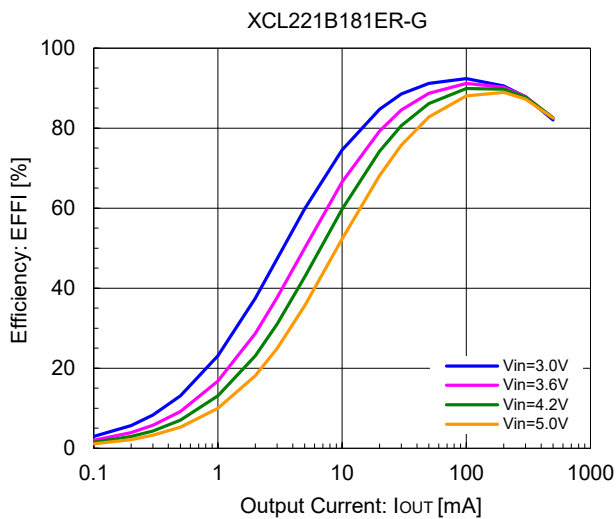
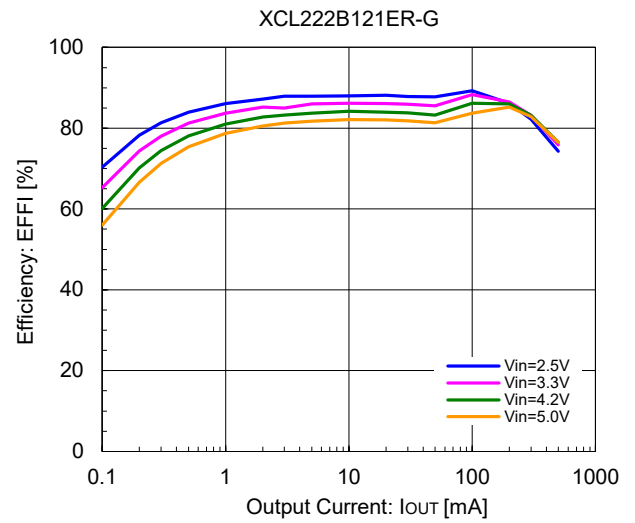
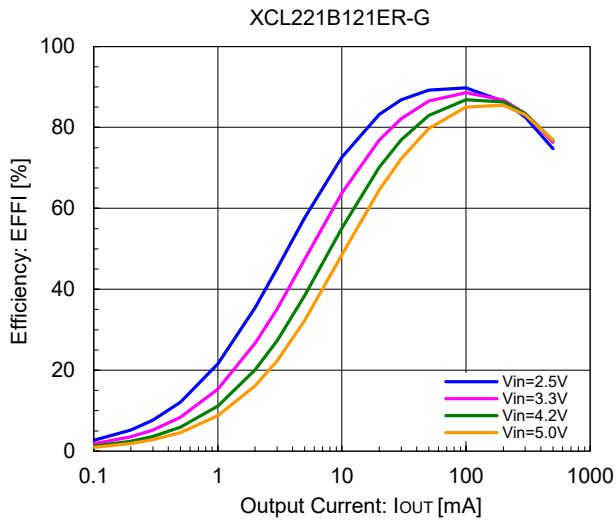

# XCL221/XCL222 Series

## TYPICAL PERFORMANCE CHARACTERISTICS(Continued)

### (3) Ripple Voltage vs. Output Current

XCL221B121ER-G



XCL222B121ER-G



XCL221B181ER-G



XCL222B181ER-G



XCL221B331ER-G

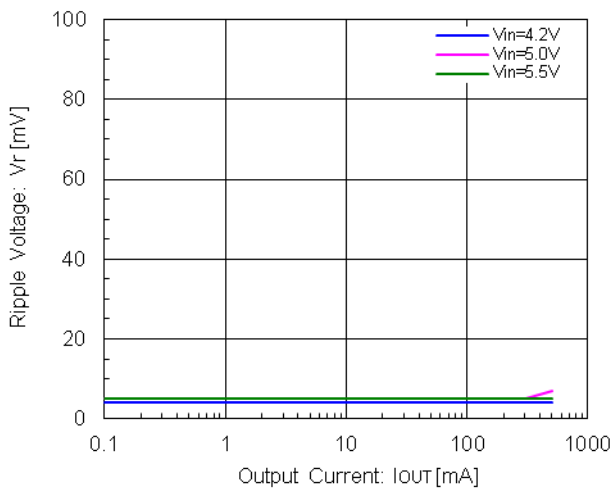

XCL222B331ER-G

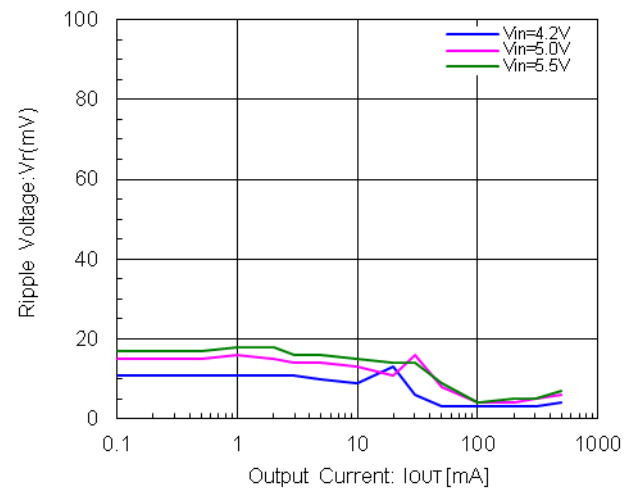

## ■ TYPICAL PERFORMANCE CHARACTERISTICS(Continued)

### 4) Ambient temperature vs Output voltage



### 5) Ambient temperature vs Quiescent current



### 6) Ambient temperature vs CE voltage

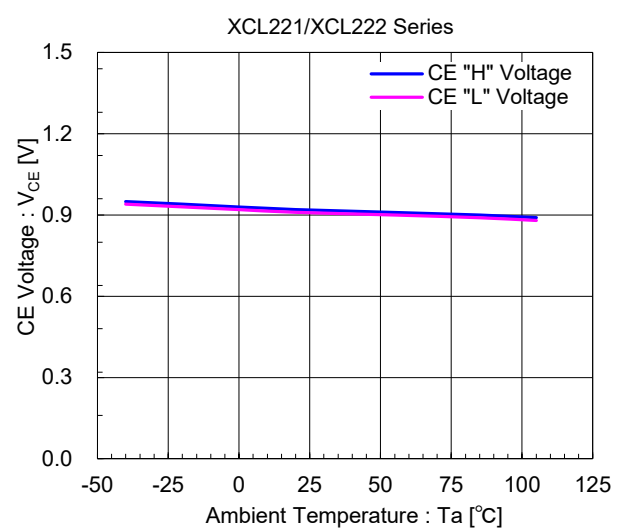

## TYPICAL PERFORMANCE CHARACTERISTICS (Continued)

### 7) Load Transient Response

(1) XCL222B181ER-G,  $V_{IN}=3.6V$ ,  $V_{OUT}=1.8V$  /  $I_{OUT}=1mA \leftrightarrow 100mA$

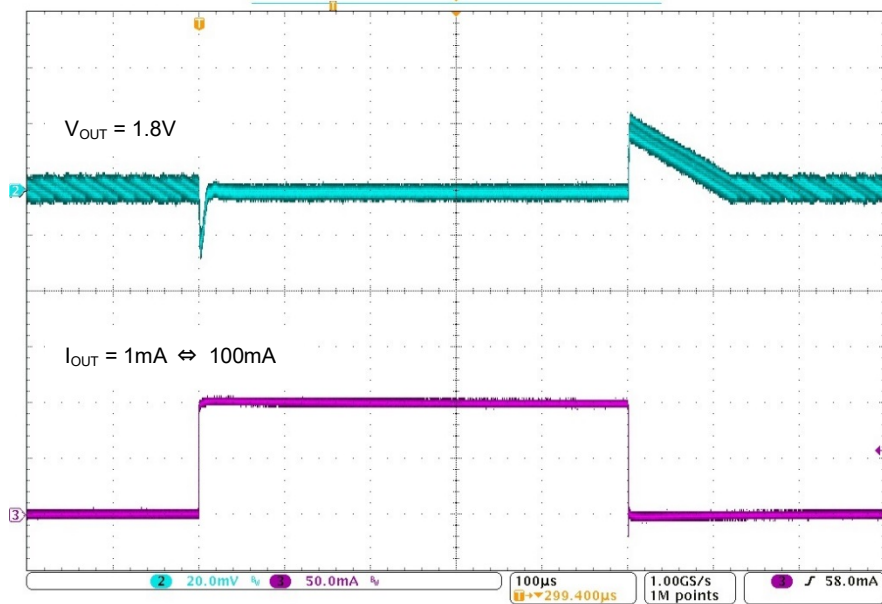

(2) XCL222B181ER-G,  $V_{IN}=3.6V$ ,  $V_{OUT}=1.8V$  /  $I_{OUT}=10mA \leftrightarrow 100mA$

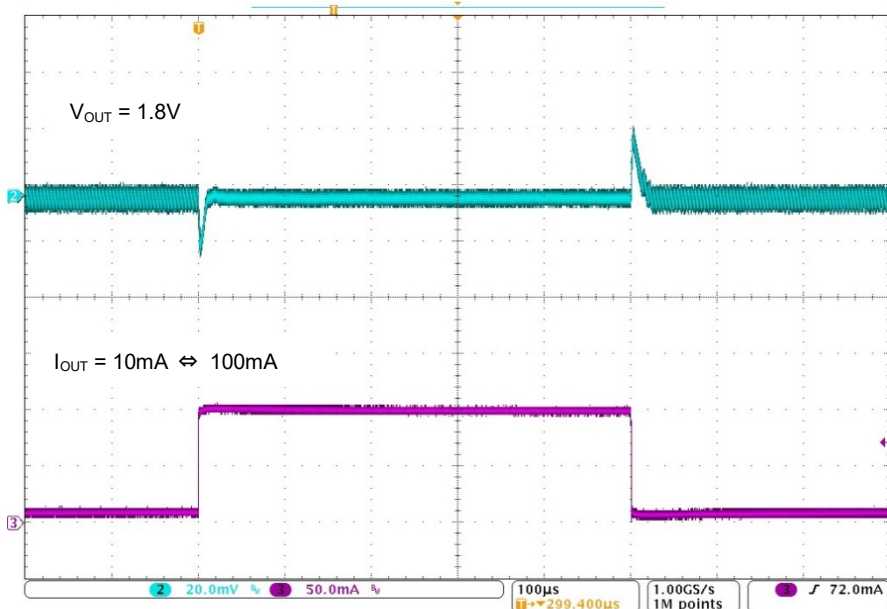



## ■ PACKAGING INFORMATION

For the latest package information go to, [www.torexsemi.com/technical-support/packages](http://www.torexsemi.com/technical-support/packages)

PACKAGE	OUTLINE / LAND PATTERN	THERMAL CHARACTERISTICS	
CL-2025-02	<a href="#">CL-2025-02 PKG</a>	Standard Board	<a href="#">CL-2025-02 Power Dissipation</a>

# XCL221/XCL222 Series

## MARKING RULE

●CL-2025-02



① represents products series

MARK	PRODUCT SERIES
7	XCL221B****-G
8	XCL222B****-G

② represents integer and oscillation frequency of the output voltage

MARK	TYPE	OUTPUT VOLTAGE(V)	OSCILLATION FREQUENCY (MHz)	PRODUCT SERIES
N	B	0.x	1.2	XCL22*B0*1**-G
P		1.x		XCL22*B1*1**-G
R		2.x		XCL22*B2*1**-G
S		3.x		XCL22*B3*1**-G

③ represents the decimal part of output voltage

OUTPUT VOLTAGE(V)	MARK	PRODUCT SERIES
X.0	0	XCL22***0***-G
X.05	A	XCL22***A***-G
X.1	1	XCL22***1***-G
X.15	B	XCL22***B***-G
X.2	2	XCL22***2***-G
X.25	C	XCL22***C***-G
X.3	3	XCL22***3***-G
X.35	D	XCL22***D***-G
X.4	4	XCL22***4***-G
X.45	E	XCL22***E***-G
X.5	5	XCL22***5***-G
X.55	F	XCL22***F***-G
X.6	6	XCL22***6***-G
X.65	H	XCL22***H***-G
X.7	7	XCL22***7***-G
X.75	K	XCL22***K***-G
X.8	8	XCL22***8***-G
X.85	L	XCL22***L***-G
X.9	9	XCL22***9***-G
X.95	M	XCL22***M***-G

④,⑤ represents production lot number

01~09, 0A~0Z, 11~9Z, A1~A9, AA~AZ, B1~ZZ in order.

(G, I, J, O, Q, W excluded)

No character inversion used.

1. The product and product specifications contained herein are subject to change without notice to improve performance characteristics. Consult us, or our representatives before use, to confirm that the information in this datasheet is up to date.
2. The information in this datasheet is intended to illustrate the operation and characteristics of our products. We neither make warranties or representations with respect to the accuracy or completeness of the information contained in this datasheet nor grant any license to any intellectual property rights of ours or any third party concerning with the information in this datasheet.
3. Applicable export control laws and regulations should be complied and the procedures required by such laws and regulations should also be followed, when the product or any information contained in this datasheet is exported.
4. The product is neither intended nor warranted for use in equipment of systems which require extremely high levels of quality and/or reliability and/or a malfunction or failure which may cause loss of human life, bodily injury, serious property damage including but not limited to devices or equipment used in 1) nuclear facilities, 2) aerospace industry, 3) medical facilities, 4) automobile industry and other transportation industry and 5) safety devices and safety equipment to control combustions and explosions. Do not use the product for the above use unless agreed by us in writing in advance.
5. Although we make continuous efforts to improve the quality and reliability of our products; nevertheless Semiconductors are likely to fail with a certain probability. So in order to prevent personal injury and/or property damage resulting from such failure, customers are required to incorporate adequate safety measures in their designs, such as system fail safes, redundancy and fire prevention features.
6. Our products are not designed to be Radiation-resistant.
7. Please use the product listed in this datasheet within the specified ranges.
8. We assume no responsibility for damage or loss due to abnormal use.
9. All rights reserved. No part of this datasheet may be copied or reproduced unless agreed by Torex Semiconductor Ltd in writing in advance.

TOREX SEMICONDUCTOR LTD.



Компания «ЭлектроПласт» предлагает заключение долгосрочных отношений при поставках импортных электронных компонентов на взаимовыгодных условиях!

Наши преимущества:

- Оперативные поставки широкого спектра электронных компонентов отечественного и импортного производства напрямую от производителей и с крупнейших мировых складов;
- Поставка более 17-ти миллионов наименований электронных компонентов;
- Поставка сложных, дефицитных, либо снятых с производства позиций;
- Оперативные сроки поставки под заказ (от 5 рабочих дней);
- Экспресс доставка в любую точку России;
- Техническая поддержка проекта, помощь в подборе аналогов, поставка прототипов;
- Система менеджмента качества сертифицирована по Международному стандарту ISO 9001;
- Лицензия ФСБ на осуществление работ с использованием сведений, составляющих государственную тайну;
- Поставка специализированных компонентов (Xilinx, Altera, Analog Devices, Intersil, Interpoint, Microsemi, Aeroflex, Peregrine, Syfer, Eurofarad, Texas Instrument, Miteq, Cobham, E2V, MA-COM, Hittite, Mini-Circuits, General Dynamics и др.);

Помимо этого, одним из направлений компании «ЭлектроПласт» является направление «Источники питания». Мы предлагаем Вам помощь Конструкторского отдела:

- Подбор оптимального решения, техническое обоснование при выборе компонента;
- Подбор аналогов;
- Консультации по применению компонента;
- Поставка образцов и прототипов;
- Техническая поддержка проекта;
- Защита от снятия компонента с производства.



#### Как с нами связаться

**Телефон:** 8 (812) 309 58 32 (многоканальный)

**Факс:** 8 (812) 320-02-42

**Электронная почта:** [org@eplast1.ru](mailto:org@eplast1.ru)

**Адрес:** 198099, г. Санкт-Петербург, ул. Калинина, дом 2, корпус 4, литера А.