

EZR32LG Wireless MCUs

EZR32LG330 Data Sheet



EZR32LG330 Wireless MCU family with ARM Cortex-M3 CPU and sub-GHz Radio

The EZR32LG Wireless MCUs are the latest in Silicon Labs family of wireless MCUs delivering a high performance, low energy wireless solution integrated into a small form factor package. By combining a high performance sub-GHz RF transceiver with an energy efficient 32-bit MCU, the EZR32LG family provides designers the ultimate in flexibility with a family of pin-compatible devices that scale with 64/128/256 kB of flash and support Silicon Labs EZRadio or EZRadioPRO transceivers. The ultra-low power operating modes and fast wake-up times of the Silicon Labs energy friendly 32-bit MCUs, combined with the low transmit and receive power consumption of the sub-GHz radio, result in a solution optimized for battery powered applications.

32-Bit ARM Cortex wireless MCUs applications include the following:

- Energy, gas, water and smart metering
- Health and fitness applications
- Consumer electronics
- Alarm and security systems
- Building and home automation

KEY FEATURES

- Silicon Labs' first 32-bit Wireless MCUs
- Based on ARM Cortex M3 (LG) and M4 (WG) CPU cores with 256 kB of flash and 32 kB RAM
- Best-in-class RF performance with EZradio and EZRadioPro transceivers
- Ultra-low power wireless MCU
 - Low transmit and receive currents
 - Ultra-low power standby and sleep modes
 - Fast wake-up time
- Low Energy sensor interface (LESENSE)
- Rich set of peripherals including 12-bit ADC and DAC, multiple communication interfaces (USB, UART, SPI, I2C), multiple GPIO and timers
- AES Accelerator with 128/256-bit keys



1. Feature List

The LG highlighted features are listed below.

MCU Features

- ARM Cortex-M3 CPU platform
 - Up to 48 MHz
 - 64/128/256 kB Flash w/32 kB RAM
 - Hardware AES with 128/256-bit keys
- Flexible Energy Management System
 - 40 nA @ 3 V Shutoff Mode
 - 0.65 μ A @ 3 V Stop Mode
 - 211 μ A/MHz @ 3 V Run Mode
- Timers/Counters
 - 4 \times Timer/Counter
 - 4 \times 3 Compare/Capture/PWM channels
 - Low Energy Timer
 - Real-Time Counter
 - 16/8-bit Pulse Counter
 - Watchdog Timer
- Communication interfaces
 - 2 \times USART (UART/SPI)
 - 2 \times UART
 - 2 \times Low Energy UART
 - 2 \times I2C Interface with SMBus support
- Ultra low power precision analog peripherals
 - 12-bit 1 Msamples/s ADC
 - On-chip temperature sensor
 - 12-bit 500 ksamples/s DAC
 - 2 \times Analog Comparator
 - 3x Operational Amplifier
- Low Energy Sensor Interface (LESENSE)
- Up to 41 General Purpose I/O pins

RF Features

- RF Features Frequency Range
 - 142-1050 MHz
- Modulation
 - (G)FSK, 4(G)FSK, (G)MSK, OOK
- Receive sensitivity up to -133 dBm
- Up to +20 dBm max output power
- Low active power consumption
 - 10/13 mA RX
 - 18 mA TX at +10 dBm
 - 6 mA @ 1.2 Kbps (Preamble Sense)
- Data rate = 100 bps to 1 Mbps
- Excellent selectivity performance
 - 69 dB adjacent channel
 - 79 dB blocking at 1 MHz
- Antenna diversity and T/R switch control
- Highly configurable packet handler
- TX and RX 64 byte FIFOs
- Automatic frequency control (AFC)
- Automatic gain control (AGC)
- IEEE 802.15.4g compliant

System Features

- Power-on Reset and Brown-Out Detector
- Debug Interface
- Temperature range -40 to 85 $^{\circ}$ C
- Single power supply 1.98 to 3.8 V
- QFN64 package

2. Ordering Information

The table below shows the available EZR32LG330 devices.

Table 2.1. Ordering Information

| Ordering | Radio | Flash (kB) | RAM (kB) | Power Amplifier (dBm) | Max Sensitivity (dBm) | Supply Voltage (V) | Package |
|-----------------|------------|------------|----------|-----------------------|-----------------------|--------------------|---------|
| EZR32LG330Fx55G | EZRadio | 64-256 | 32 | +13 | -116 | 1.98 - 3.8 | QFN64 |
| EZR32LG330Fx60G | EZRadioPro | 64-256 | 32 | +13 | -129 | 1.98 - 3.8 | QFN64 |
| EZR32LG330Fx61G | EZRadioPro | 64-256 | 32 | +16 | -129 | 1.98 - 3.8 | QFN64 |
| EZR32LG330Fx63G | EZRadioPro | 64-256 | 32 | +20 | -129 | 1.98 - 3.8 | QFN64 |
| EZR32LG330Fx67G | EZRadioPro | 64-256 | 32 | +13 | -133 | 1.98 - 3.8 | QFN64 |
| EZR32LG330Fx68G | EZRadioPro | 64-256 | 32 | +20 | -133 | 1.98 - 3.8 | QFN64 |
| EZR32LG330Fx69G | EZRadioPro | 64-256 | 32 | +13 & 20 | -133 | 1.98 - 3.8 | QFN64 |

Table 2.2. Flash Sizes

| Example Part Number | Flash Size |
|---------------------|------------|
| EZR32LG330FE55G | 64 kB |
| EZR32LG330FF55G | 128 kB |
| EZR32LG330FG55G | 256 kB |

Note: Add an "(R)" at the end of the device part number to denote tape and reel option.

Visit www.silabs.com for information on global distributors and representatives.

3. System Overview

3.1 Introduction

The EZR32LG330 Wireless MCUs are the latest in Silicon Labs family of wireless MCUs delivering a high performance, low energy wireless solution integrated into a small form factor package. By combining a high performance sub-GHz RF transceiver with an energy efficient 32-bit ARM Cortex-M3, the EZR32LG family provides designers with the ultimate in flexibility with a family of pin-compatible parts that scale from 64 to 256 kB of flash and support Silicon Labs EZRadio or EZRadioPRO transceivers. The ultra-low power operating modes and fast wake-up times combined with the low transmit and receive power consumption of the sub-GHz radio, results in a solution optimized for low power and battery powered applications. For a complete feature set and in-depth information on the modules, the reader is referred to the EZR32LG Reference Manual.

The EZR32LG330 block diagram is shown below.



Figure 3.1. Block Diagram

3.1.1 ARM Cortex-M3 Core

The ARM Cortex-M3 includes a 32-bit RISC processor which can achieve as much as 1.25 Dhrystone MIPS/MHz. A Memory Protection Unit with support for up to 8 memory segments is included, as well as a Wake-up Interrupt Controller handling interrupts triggered while the CPU is asleep. The EZR32 implementation of the Cortex-M3 is described in detail in *EZR32 Cortex-M3 Reference Manual*.

3.1.2 Debugging

These devices include hardware debug support through a 2-pin serial-wire debug interface and an Embedded Trace Module (ETM) for data/instruction tracing. In addition there is also a 1-wire Serial Wire Viewer pin which can be used to output profiling information, data trace and software-generated messages.

3.1.3 Memory System Controller (MSC)

The Memory System Controller (MSC) is the program memory unit of the EZR32LG microcontroller. The flash memory is readable and writable from both the Cortex-M3 and DMA. The flash memory is divided into two blocks; the main block and the information block. Program code is normally written to the main block. Additionally, the information block is available for special user data and flash lock bits. There is also a read-only page in the information block containing system and device calibration data. Read and write operations are supported in the energy modes EM0 and EM1.

3.1.4 Direct Memory Access Controller (DMA)

The Direct Memory Access (DMA) controller performs memory operations independently of the CPU. This has the benefit of reducing the energy consumption and the workload of the CPU, and enables the system to stay in low energy modes when moving for instance data from the USART to RAM or from the External Bus Interface to a PWM-generating timer. The DMA controller uses the PL230 μ DMA controller licensed from ARM.

3.1.5 Reset Management Unit (RMU)

The RMU is responsible for handling the reset functionality of the EZR32LG.

3.1.6 Energy Management Unit (EMU)

The Energy Management Unit (EMU) manage all the low energy modes (EM) in EZR32LG microcontrollers. Each energy mode manages if the CPU and the various peripherals are available. The EMU can also be used to turn off the power to unused SRAM blocks.

3.1.7 Clock Management Unit (CMU)

The Clock Management Unit (CMU) is responsible for controlling the oscillators and clocks on-board the EZR32LG. The CMU provides the capability to turn on and off the clock on an individual basis to all peripheral modules in addition to enable/disable and configure the available oscillators. The high degree of flexibility enables software to minimize energy consumption in any specific application by not wasting power on peripherals and oscillators that are inactive.

3.1.8 Watchdog (WDOG)

The purpose of the watchdog timer is to generate a reset in case of a system failure, to increase application reliability. The failure may e.g. be caused by an external event, such as an ESD pulse, or by a software failure.

3.1.9 Peripheral Reflex System (PRS)

The Peripheral Reflex System (PRS) system is a network which lets the different peripheral module communicate directly with each other without involving the CPU. Peripheral modules which send out Reflex signals are called producers. The PRS routes these reflex signals to consumer peripherals which apply actions depending on the data received. The format for the Reflex signals is not given, but edge triggers and other functionality can be applied by the PRS.

3.1.10 Universal Serial Bus Controller (USB)

The USB is a full-speed USB 2.0 compliant OTG host/device controller. The USB can be used in Device, On-the-go (OTG) Dual Role Device or Host-only configuration. In OTG mode the USB supports both Host Negotiation Protocol (HNP) and Session Request Protocol (SRP). The device supports both fullspeed (12 MBit/s) and low speed (1.5 MBit/s) operation. The USB device includes an internal dedicated Descriptor-Based Scatter/Gather DMA and supports up to 6 OUT endpoints and 6 IN endpoints, in addition to endpoint 0. The on-chip PHY includes all OTG features, except for the voltage booster for supplying 5 V to VBUS when operating as host.

3.1.11 Inter-Integrated Circuit Interface (I²C)

The I²C module provides an interface between the MCU and a serial I²C-bus. It is capable of acting as both a master and a slave, and supports multi-master buses. Both standard-mode, fast-mode and fast-mode plus speeds are supported, allowing transmission rates all the way from 10 kbit/s up to 1 Mbit/s. Slave arbitration and timeouts are also provided to allow implementation of an SMBus compliant system. The interface provided to software by the I²C module, allows both fine-grained control of the transmission process and close to automatic transfers. Automatic recognition of slave addresses is provided in all energy modes.

3.1.12 Universal Synchronous/Asynchronous Receiver/Transmitter (USART)

The Universal Synchronous Asynchronous serial Receiver and Transmitter (USART) is a very flexible serial I/O module. It supports full duplex asynchronous UART communication as well as RS-485, SPI, MicroWire and 3-wire. It can also interface with ISO7816 Smart-Cards, and I2S devices.

3.1.13 Pre-Programmed UART Bootloader

The bootloader presented in application note AN0003 is pre-programmed in the device at factory. Autobaud and destructive write are supported. The autobaud feature, interface and commands are described further in the application note.

3.1.14 Universal Asynchronous Receiver/Transmitter (UART)

The Universal Asynchronous serial Receiver and Transmitter (UART) is a very flexible serial I/O module. It supports full- and half-duplex asynchronous UART communication.

3.1.15 Low Energy Universal Asynchronous Receiver/Transmitter (LEUART)

The unique LEUART™, the Low Energy UART, is a UART that allows two-way UART communication on a strict power budget. Only a 32.768 kHz clock is needed to allow UART communication up to 9600 baud/s. The LEUART includes all necessary hardware support to make asynchronous serial communication possible with minimum of software intervention and energy consumption.

3.1.16 Timer/Counter (TIMER)

The 16-bit general purpose Timer has 3 compare/capture channels for input capture and compare/Pulse-Width Modulation (PWM) output. TIMER0 also includes a Dead-Time Insertion module suitable for motor control applications.

3.1.17 Real Time Counter (RTC)

The Real Time Counter (RTC) contains a 24-bit counter and is clocked either by a 32.768 kHz crystal oscillator, or a 32.768 kHz RC oscillator. In addition to energy modes EM0 and EM1, the RTC is also available in EM2. This makes it ideal for keeping track of time since the RTC is enabled in EM2 where most of the device is powered down.

3.1.18 Backup Real Time Counter (BURTC)

The Backup Real Time Counter (BURTC) contains a 32-bit counter and is clocked either by a 32.768 kHz crystal oscillator, a 32.768 kHz RC oscillator or a 1 kHz ULFRCO. The BURTC is available in all Energy Modes and it can also run in backup mode, making it operational even if the main power should drain out.

3.1.19 Low Energy Timer (LETIMER)

The unique LETIMER™, the Low Energy Timer, is a 16-bit timer that is available in energy mode EM2 in addition to EM1 and EM0. Because of this, it can be used for timing and output generation when most of the device is powered down, allowing simple tasks to be performed while the power consumption of the system is kept at an absolute minimum. The LETIMER can be used to output a variety of waveforms with minimal software intervention. It is also connected to the Real Time Counter (RTC), and can be configured to start counting on compare matches from the RTC.

3.1.20 Pulse Counter (PCNT)

The Pulse Counter (PCNT) can be used for counting pulses on a single input or to decode quadrature encoded inputs. It runs off either the internal LFACLK or the PCNTn_S0IN pin as external clock source. The module may operate in energy mode EM0 - EM3.

3.1.21 Analog Comparator (ACMP)

The Analog Comparator is used to compare the voltage of two analog inputs, with a digital output indicating which input voltage is higher. Inputs can either be one of the selectable internal references or from external pins. Response time and thereby also the current consumption can be configured by altering the current supply to the comparator.

3.1.22 Voltage Comparator (VCMP)

The Voltage Supply Comparator is used to monitor the supply voltage from software. An interrupt can be generated when the supply falls below or rises above a programmable threshold. Response time and thereby also the current consumption can be configured by altering the current supply to the comparator.

3.1.23 Analog to Digital Converter (ADC)

The ADC is a Successive Approximation Register (SAR) architecture, with a resolution of up to 12 bits at up to one million samples per second. The integrated input mux can select inputs from 8 external pins and 6 internal signals.

3.1.24 Digital to Analog Converter (DAC)

The Digital to Analog Converter (DAC) can convert a digital value to an analog output voltage. The DAC is fully differential rail-to-rail, with 12-bit resolution. It has two single ended output buffers which can be combined into one differential output. The DAC may be used for a number of different applications such as sensor interfaces or sound output.

3.1.25 Operational Amplifier (OPAMP)

The EZR32LG330 features 2 Operational Amplifiers. The Operational Amplifier is a versatile general purpose amplifier with rail-to-rail differential input and rail-to-rail single ended output. The input can be set to pin, DAC or OPAMP, whereas the output can be pin, OPAMP or ADC. The current is programmable and the OPAMP has various internal configurations such as unity gain, programmable gain using internal resistors, etc.

3.1.26 Low Energy Sensor Interface (LESENSE)

The Low Energy Sensor Interface (LESENSE™), is a highly configurable sensor interface with support for up to 16 individually configurable sensors. By controlling the analog comparators and DAC, LESENSE is capable of supporting a wide range of sensors and measurement schemes, and can for instance measure LC sensors, resistive sensors and capacitive sensors. LESENSE also includes a programmable FSM which enables simple processing of measurement results without CPU intervention. LESENSE is available in energy mode EM2, in addition to EM0 and EM1, making it ideal for sensor monitoring in applications with a strict energy budget.

3.1.27 Backup Power Domain

The backup power domain is a separate power domain containing a Backup Real Time Counter, BURTC, and a set of retention registers, available in all energy modes. This power domain can be configured to automatically change power source to a backup battery when the main power drains out. The backup power domain enables the EZR32LG330 to keep track of time and retain data, even if the main power source should drain out.

3.1.28 Advanced Encryption Standard Accelerator (AES)

The AES accelerator performs AES encryption and decryption with 128-bit or 256-bit keys. Encrypting or decrypting one 128-bit data block takes 52 HFCORECLK cycles with 128-bit keys and 75 HFCORECLK cycles with 256-bit keys. The AES module is an AHB slave which enables efficient access to the data and key registers. All write accesses to the AES module must be 32-bit operations (i.e., 8- or 16-bit operations are not supported).

3.1.29 General Purpose Input/Output (GPIO)

In the EZR32LG330, there are 41 General Purpose Input/Output (GPIO) pins, which are divided into ports with up to 16 pins each. These pins can individually be configured as either an output or input. More advanced configurations like open-drain, filtering and drive strength can also be configured individually for the pins. The GPIO pins can also be overridden by peripheral pin connections, like Timer PWM outputs or USART communication, which can be routed to several locations on the device. The GPIO supports up to 16 asynchronous external pin interrupts, which enables interrupts from any pin on the device. Also, the input value of a pin can be routed through the Peripheral Reflex System to other peripherals.

3.1.30 EZRadio® and EZRadioPro® Transceivers

The EZR32LG family of devices is built using high-performance, low-current EZRadio and EZRadioPro RF transceivers covering the sub-GHz frequency bands from 142 to 1050 MHz. These devices offer outstanding sensitivity of upto -133 dBm (using EZRadioPro) while achieving extremely low active and standby current consumption. The EZR32LG devices using the EZRadioPro transceiver offer frequency coverage in all major bands and include optimal phase noise, blocking, and selectivity performance for narrow band and licensed band applications, such as FCC Part 90 and 169 MHz wireless Mbus. The 69 dB adjacent channel selectivity with 12.5 kHz channel spacing ensures robust receive operation in harsh RF conditions, which is particularly important for narrow band operation. The active mode TX current consumption of 18 mA at +10 dBm and RX current of 10 mA coupled with extremely low standby current and fast wake times is optimized for extended battery life in the most demanding applications. The EZR32LG devices can achieve up to +27 dBm output power with built-in ramping control of a low-cost external FET. The devices can meet worldwide regulatory standards: FCC, ETSI, and ARIB. All devices are designed to be compliant with 802.15.4g and WMBus smart metering standards. The devices are highly flexible and can be programmed and configured via Simplicity Studio, available at www.silabs.com.

Communication between the radio and MCU are done over USART, PRS and IRQ, which requires the pins to be configured in the following way:

Table 3.1. Radio MCU Communication Configuration

| EZR32LG Pin | Radio Assignment | EZR32LG Function Assignment |
|-------------|------------------|---|
| PE8 | SDN | GPIO Output |
| PE9 | \bar{n} SEL | Bit-Banged SPI.CS (GPIO Output) |
| PE10 | SDI | US0_TX #0 |
| PE11 | SDO | US0_RX #0 |
| PE12 | SCLK | US0_CLK #0 |
| PE13 | \bar{n} IRQ | GPIO_EM4WU5 (GPIO Input with IRQ enabled) |
| PE14 | GPIO1 | PRS Input |
| PA15 | GPIO0 | PRS Input |

3.2 Configuration Summary

The features of the EZR32LG330 is a subset of the feature set described in the *EZR32LGReference Manual*. The table below describes device specific implementation of the features.

Table 3.2. Configuration Summary

| Module | Configuration | Pin Connections |
|-----------|---|---------------------------------|
| Cortex-M3 | Full configuration | NA |
| DBG | Full configuration | DBG_SWCLK, DBG_SWDIO, DBG_SWO |
| MSC | Full configuration | NA |
| DMA | Full configuration | NA |
| RMU | Full configuration | NA |
| EMU | Full configuration | NA |
| CMU | Full configuration | CMU_OUT0, CMU_OUT1 |
| WDOG | Full configuration | NA |
| PRS | Full configuration | NA |
| I2C0 | Full configuration | I2C0_SDA, I2C0_SCL |
| I2C1 | Full configuration | I2C1_SDA, I2C1_SCL |
| USART0 | Full configuration with IrDA | US0_TX, US0_RX, US0_CLK, US0_CS |
| USART1 | Full configuration with I2S | US1_TX, US1_RX, US1_CLK, US1_CS |
| USART2 | Full configuration with I2S | US2_TX, US2_RX, US2_CLK, US2_CS |
| UART0 | Full configuration | U0_TX, U0_RX |
| UART1 | Full configuration | U1_TX, U1_RX |
| LEUART0 | Full configuration | LEU0_TX, LEU0_RX |
| LEUART1 | Full configuration | LEU1_TX, LEU1_RX |
| TIMER0 | Full configuration with DTI | TIM0_CC[2:0], TIM0_CDTI[2:0] |
| TIMER1 | Full configuration | TIM1_CC[2:0] |
| TIMER2 | Full configuration | TIM2_CC[2:0] |
| TIMER3 | Full configuration | TIM3_CC[2:0] |
| RTC | Full configuration | NA |
| BURTC | Full configuration | NA |
| LETIMER0 | Full configuration | LET0_O[1:0] |
| PCNT0 | Full configuration, 16-bit count register | PCNT0_S[1:0] |
| PCNT1 | Full configuration, 8-bit count register | PCNT1_S[1:0] |
| PCNT2 | Full configuration, 8-bit count register | PCNT2_S[1:0] |
| ACMP0 | Full configuration | ACMP0_CH[7:0], ACMP0_O |
| ACMP1 | Full configuration | ACMP1_CH[7:0], ACMP1_O |
| VCMP | Full configuration | NA |
| ADC0 | Full configuration | ADC0_CH[7:0] |
| DAC0 | Full configuration | DAC0_OUT[1:0] |

| Module | Configuration | Pin Connections |
|--------|--------------------|---|
| OPAMP | Full configuration | Outputs: OPAMP_OUTx, OPAMP_OUT-xALT, Inputs: OPAMP_Px, OPAMP_Nx |
| AES | Full configuration | NA |
| GPIO | 41 pins | Available pins are shown in 5.4 GPIO Pin-out Overview |

3.3 Memory Map

The EZR32LG330 memory map is shown below with RAM and flash sizes for the largest memory configuration.

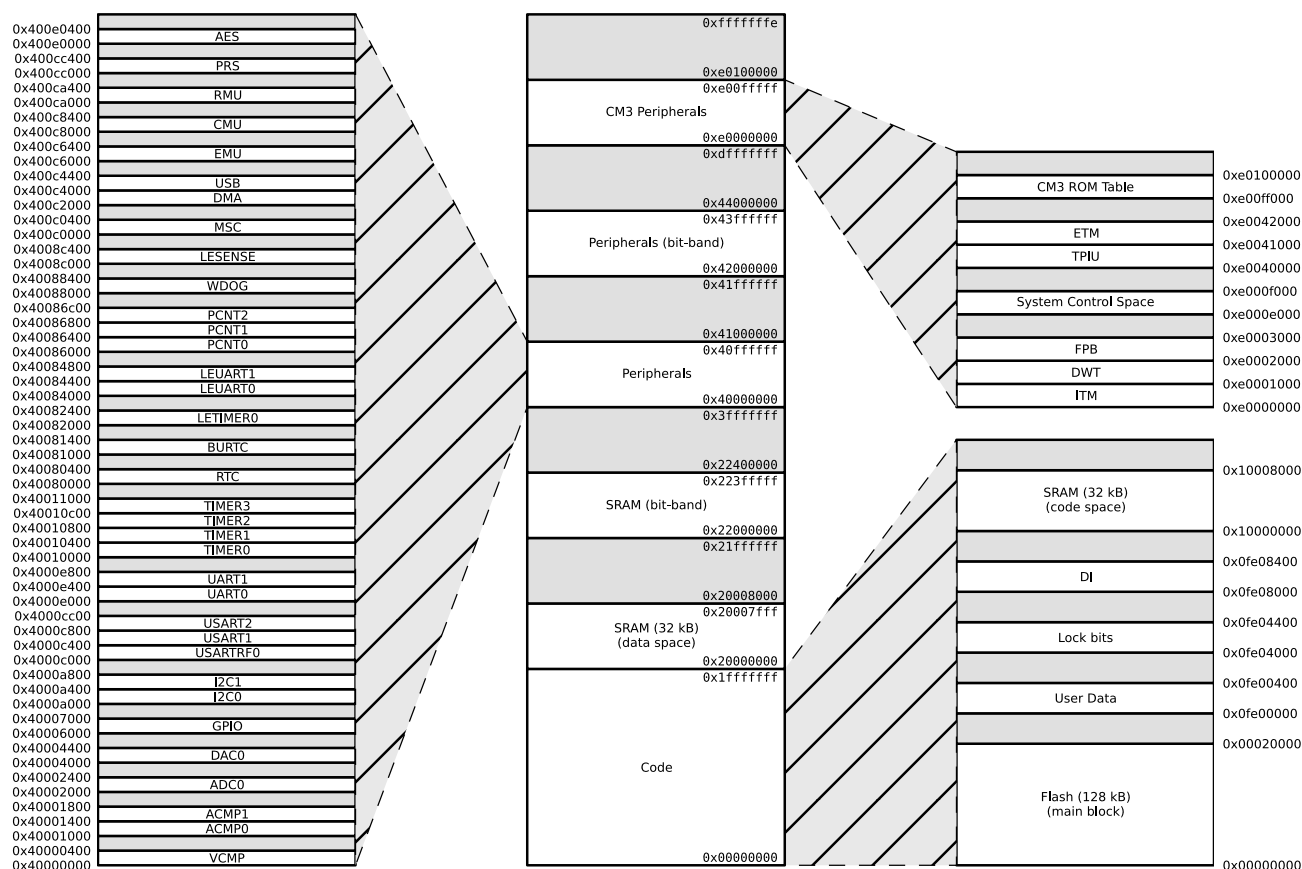

Figure 3.2. EZR32LG330 Memory Map with Largest RAM and Flash Sizes

4. Electrical Specifications

4.1 Test Conditions

4.1.1 Typical Values

The typical data are based on $T_{AMB}=25\text{ }^{\circ}\text{C}$ and $V_{DD}=3.0\text{ V}$, as defined in [Table 4.3 General Operating Conditions on page 11](#), by simulation and/or technology characterisation unless otherwise specified.

4.1.2 Minimum and Maximum Values

The minimum and maximum values represent the worst conditions of ambient temperature, supply voltage and frequencies, as defined in [Table 4.3 General Operating Conditions on page 11](#), by simulation and/or technology characterisation unless otherwise specified.

4.2 Absolute Maximum Ratings

The absolute maximum ratings are stress ratings, and functional operation under such conditions are not guaranteed. Stress beyond the limits specified in the table below may affect the device reliability or cause permanent damage to the device. Functional operating conditions are given in [Table 4.3 General Operating Conditions on page 11](#).

Table 4.1. Absolute Maximum Ratings

| Parameter | Symbol | Test Condition | Min | Typ | Max | Unit |
|-------------------------------|-------------|--|------|-----|------------------|--------------------|
| Storage temperature range | T_{STG} | | -55 | — | 150 ¹ | $^{\circ}\text{C}$ |
| Maximum soldering temperature | T_S | Latest IPC/ JEDEC J- STD-020 Stand- ard | — | — | 260 | $^{\circ}\text{C}$ |
| External main supply voltage | V_{DDMAX} | | 0 | — | 3.8 | V |
| Voltage on any I/O pin | V_{IOPIN} | | -0.3 | — | $V_{DD}+0.3$ | V |

Note:

1. Based on programmed devices tested for 10000 hours at 150 $^{\circ}\text{C}$. Storage temperature affects retention of preprogrammed calibration values stored in flash. Please refer to the Flash section in the Electrical Characteristics for information on flash data retention for different temperatures.

4.3 Thermal Characteristics

Table 4.2. Thermal Conditions

| Parameter | Symbol | Test Condition | Min | Typ | Max | Unit |
|---------------------------------------|-----------|------------------------------|-----|-----|-------------------|------|
| Ambient temperature range | T_{AMB} | | -40 | — | 85 | °C |
| Junction temperature value | T_J | | — | — | 105 ¹ | °C |
| Thermal impedance junction to ambient | T_{lJA} | +13/+16 dBm on 2-layer board | — | — | 61.8 | °C/W |
| | | +20 dBm on 4-layer board | — | — | 20.7 ² | °C/W |
| Storage temperature range | T_{STG} | | -55 | — | 150 | °C |

Note:

1. Values are based on simulations run on 2 layer and 4 layer PCBs at 0m/s airflow.
2. Based on programmed devices tested for 10000 hours at 150 °C. Storage temperature affects retention of preprogrammed calibration values stored in flash. Please refer to the Flash section in the Electrical Characteristics for information on flash data retention for different temperatures.

4.4 General Operating Conditions

Table 4.3. General Operating Conditions

| Parameter | Symbol | Min | Typ | Max | Unit |
|------------------------------|------------|------|-----|-----|------|
| Ambient temperature range | T_{AMB} | -40 | — | 85 | °C |
| Operating supply voltage | V_{DDOP} | 1.98 | — | 3.8 | V |
| Internal APB clock frequency | f_{APB} | — | — | 48 | MHz |
| Internal AHB clock frequency | f_{AHB} | — | — | 48 | MHz |

Table 4.4. Environmental

| Parameter | Symbol | Test Condition | Min | Typ | Max | Unit |
|---------------------------------|--------------|------------------------|-----|-----|------|------|
| ESD (Human Body Model HBM) | V_{ESDHBM} | $T_{AMB}=25\text{ °C}$ | — | — | 2000 | V |
| ESD (Charged Device Model, CDM) | V_{ESDCDM} | $T_{AMB}=25\text{ °C}$ | — | — | 500 | V |

Latch-up sensitivity passed: $\pm 100\text{ mA}/1.5 \times V_{SUPPLY(max)}$ according to JEDEC JESD 78 method Class II, 85 °C.

4.5 Current Consumption

Table 4.5. Current Consumption

| Parameter | Symbol | Test Condition | Min | Typ | Max | Unit |
|--|-----------|---|-----|--------------------------|-----|--------------------------|
| EM0 current. No prescaling. Running prime number calculation code from Flash. (Production test condition = 14 MHz) | I_{EM0} | 48 MHz HFXO, all peripheral clocks disabled, $V_{DD}=3.0\text{ V}$, $T_{AMB}=25\text{ }^{\circ}\text{C}$ | — | 211 | 225 | $\mu\text{A}/\text{MHz}$ |
| | | 48 MHz HFXO, all peripheral clocks disabled, $V_{DD}=3.0\text{ V}$, $T_{AMB}=85\text{ }^{\circ}\text{C}$ | — | 211 | 230 | $\mu\text{A}/\text{MHz}$ |
| | | 28 MHz HFRCO, all peripheral clocks disabled, $V_{DD}=3.0\text{ V}$, $T_{AMB}=25\text{ }^{\circ}\text{C}$ | — | 212 | 220 | $\mu\text{A}/\text{MHz}$ |
| | | 28 MHz HFRCO, all peripheral clocks disabled, $V_{DD}=3.0\text{ V}$, $T_{AMB}=85\text{ }^{\circ}\text{C}$ | — | 213 | 223 | $\mu\text{A}/\text{MHz}$ |
| | | 21 MHz HFRCO, all peripheral clocks disabled, $V_{DD}=3.0\text{ V}$, $T_{AMB}=25\text{ }^{\circ}\text{C}$ | — | 214 | 224 | $\mu\text{A}/\text{MHz}$ |
| | | 21 MHz HFRCO, all peripheral clocks disabled, $V_{DD}=3.0\text{ V}$, $T_{AMB}=85\text{ }^{\circ}\text{C}$ | — | 215 | 226 | $\mu\text{A}/\text{MHz}$ |
| | | 14 MHz HFRCO, all peripheral clocks disabled, $V_{DD}=3.0\text{ V}$, $T_{AMB}=25\text{ }^{\circ}\text{C}$ | — | 216 | 231 | $\mu\text{A}/\text{MHz}$ |
| | | 14 MHz HFRCO, all peripheral clocks disabled, $V_{DD}=3.0\text{ V}$, $T_{AMB}=85\text{ }^{\circ}\text{C}$ | — | 217 | 237 | $\mu\text{A}/\text{MHz}$ |
| | | 11 MHz HFRCO, all peripheral clocks disabled, $V_{DD}=3.0\text{ V}$, $T_{AMB}=25\text{ }^{\circ}\text{C}$ | — | 218 | 239 | $\mu\text{A}/\text{MHz}$ |
| | | 11 MHz HFRCO, all peripheral clocks disabled, $V_{DD}=3.0\text{ V}$, $T_{AMB}=85\text{ }^{\circ}\text{C}$ | — | 219 | 239 | $\mu\text{A}/\text{MHz}$ |
| | | 6.6 MHz HFRCO, all peripheral clocks disabled, $V_{DD}=3.0\text{ V}$, $T_{AMB}=25\text{ }^{\circ}\text{C}$ | — | 224 | 242 | $\mu\text{A}/\text{MHz}$ |
| | | 6.6 MHz HFRCO, all peripheral clocks disabled, $V_{DD}=3.0\text{ V}$, $T_{AMB}=85\text{ }^{\circ}\text{C}$ | — | 224 | 250 | $\mu\text{A}/\text{MHz}$ |
| | | 1.2 MHz HFRCO, all peripheral clocks disabled, $V_{DD}=3.0\text{ V}$, $T_{AMB}=25\text{ }^{\circ}\text{C}$ | — | 257 | 285 | $\mu\text{A}/\text{MHz}$ |
| 1.2 MHz HFRCO, all peripheral clocks disabled, $V_{DD}=3.0\text{ V}$, $T_{AMB}=85\text{ }^{\circ}\text{C}$ | — | 261 | 293 | $\mu\text{A}/\text{MHz}$ | | |

| Parameter | Symbol | Test Condition | Min | Typ | Max | Unit |
|--|-----------|--|-----|-------------------|------------------|--------------------------|
| EM1 current (Production test condition = 14 MHz) | I_{EM1} | 48 MHz HFXO, all peripheral clocks disabled, $V_{DD}=3.0\text{ V}$, $T_{AMB}=25\text{ }^{\circ}\text{C}$ | — | 63 | 75 | $\mu\text{A}/\text{MHz}$ |
| | | 48 MHz HFXO, all peripheral clocks disabled, $V_{DD}=3.0\text{ V}$, $T_{AMB}=85\text{ }^{\circ}\text{C}$ | — | 65 | 76 | $\mu\text{A}/\text{MHz}$ |
| | | 28 MHz HFRCO, all peripheral clocks disabled, $V_{DD}=3.0\text{ V}$, $T_{AMB}=25\text{ }^{\circ}\text{C}$ | — | 64 | 75 | $\mu\text{A}/\text{MHz}$ |
| | | 28 MHz HFRCO, all peripheral clocks disabled, $V_{DD}=3.0\text{ V}$, $T_{AMB}=85\text{ }^{\circ}\text{C}$ | — | 65 | 77 | $\mu\text{A}/\text{MHz}$ |
| | | 21 MHz HFRCO, all peripheral clocks disabled, $V_{DD}=3.0\text{ V}$, $T_{AMB}=25\text{ }^{\circ}\text{C}$ | — | 65 | 76 | $\mu\text{A}/\text{MHz}$ |
| | | 21 MHz HFRCO, all peripheral clocks disabled, $V_{DD}=3.0\text{ V}$, $T_{AMB}=85\text{ }^{\circ}\text{C}$ | — | 66 | 78 | $\mu\text{A}/\text{MHz}$ |
| | | 14 MHz HFRCO, all peripheral clocks disabled, $V_{DD}=3.0\text{ V}$, $T_{AMB}=25\text{ }^{\circ}\text{C}$ | — | 67 | 79 | $\mu\text{A}/\text{MHz}$ |
| | | 14 MHz HFRCO, all peripheral clocks disabled, $V_{DD}=3.0\text{ V}$, $T_{AMB}=85\text{ }^{\circ}\text{C}$ | — | 68 | 82 | $\mu\text{A}/\text{MHz}$ |
| | | 11 MHz HFRCO, all peripheral clocks disabled, $V_{DD}=3.0\text{ V}$, $T_{AMB}=25\text{ }^{\circ}\text{C}$ | — | 68 | 81 | $\mu\text{A}/\text{MHz}$ |
| | | 11 MHz HFRCO, all peripheral clocks disabled, $V_{DD}=3.0\text{ V}$, $T_{AMB}=85\text{ }^{\circ}\text{C}$ | — | 70 | 83 | $\mu\text{A}/\text{MHz}$ |
| | | 6.6 MHz HFRCO, all peripheral clocks disabled, $V_{DD}=3.0\text{ V}$, $T_{AMB}=25\text{ }^{\circ}\text{C}$ | — | 74 | 87 | $\mu\text{A}/\text{MHz}$ |
| | | 6.6 MHz HFRCO, all peripheral clocks disabled, $V_{DD}=3.0\text{ V}$, $T_{AMB}=85\text{ }^{\circ}\text{C}$ | — | 76 | 89 | $\mu\text{A}/\text{MHz}$ |
| | | 1.2 MHz HFRCO. all peripheral clocks disabled, $V_{DD}=3.0\text{ V}$, $T_{AMB}=25\text{ }^{\circ}\text{C}$ | — | 106 | 120 | $\mu\text{A}/\text{MHz}$ |
| | | 1.2 MHz HFRCO. all peripheral clocks disabled, $V_{DD}=3.0\text{ V}$, $T_{AMB}=85\text{ }^{\circ}\text{C}$ | — | 112 | 129 | $\mu\text{A}/\text{MHz}$ |
| EM2 current | I_{EM2} | EM2 current with RTC prescaled to 1 Hz, 32.768 kHz LFRCO, $V_{DD}=3.0\text{ V}$, $T_{AMB}=25\text{ }^{\circ}\text{C}$ | — | 0.95 ¹ | 1.7 | μA |
| | | EM2 current with RTC prescaled to 1 Hz, 32.768 kHz LFRCO, $V_{DD}=3.0\text{ V}$, $T_{AMB}=85\text{ }^{\circ}\text{C}$ | — | 3.0 ¹ | 4.0 ¹ | μA |
| EM3 current | I_{EM3} | $V_{DD}=3.0\text{ V}$, $T_{AMB}=25\text{ }^{\circ}\text{C}$ | — | 0.65 | 1.3 | μA |
| | | $V_{DD}=3.0\text{ V}$, $T_{AMB}=85\text{ }^{\circ}\text{C}$ | — | 2.65 | 4.0 | μA |
| EM4 current | I_{EM4} | $V_{DD}=3.0\text{ V}$, $T_{AMB}=25\text{ }^{\circ}\text{C}$ | — | 0.02 | 0.055 | μA |
| | | $V_{DD}=3.0\text{ V}$, $T_{AMB}=85\text{ }^{\circ}\text{C}$ | — | 0.44 | 0.9 | μA |
| Note: 1. Using backup RTC. | | | | | | |

4.6 Transitions between Energy Modes

The transition times are measured from the trigger to the first clock edge in the CP.

Table 4.6. Energy Modes Transitions

| Parameter | Symbol | Min | Typ | Max | Unit |
|---------------------------------|------------|-----|-----|-----|------------------|
| Transition time from EM1 to EM0 | t_{EM10} | — | 0 | — | HFCORECLK cycles |
| Transition time from EM2 to EM0 | t_{EM20} | — | 2 | — | μs |
| Transition time from EM3 to EM0 | t_{EM30} | — | 2 | — | μs |
| Transition time from EM4 to EM0 | t_{EM40} | — | 163 | — | μs |

4.7 Power Management

The EZR32LG requires the AVDD_x, VDD_DREG and IOVDD_x pins to be connected together (with optional filter) at the PCB level. For practical schematic recommendations, please see the application note, AN0002: *EFM32 Hardware Design Considerations*.

Table 4.7. Power Management

| Parameter | Symbol | Test Condition | Min | Typ | Max | Unit |
|--|------------------|--|------|------|------|---------------|
| BOD threshold on falling external supply voltage | $V_{BODextthr-}$ | | 1.74 | — | 1.96 | V |
| BOD threshold on falling internally regulated supply voltage | $V_{BODintthr-}$ | | 1.57 | — | 1.7 | V |
| BOD threshold on rising external supply voltage | $V_{BODextthr+}$ | | — | 1.85 | 1.98 | V |
| Power-on Reset (POR) threshold on rising external supply voltage | $V_{PORthr+}$ | | — | — | 1.98 | V |
| Delay from reset is released until program execution starts | t_{RESET} | Applies to Power-on Reset, Brown-out Reset and pin reset. | — | 163 | — | μs |
| Voltage regulator decoupling capacitor. | $C_{DECOUPLE}$ | X5R capacitor recommended. Apply between DECOUPLE pin and GROUND | — | 1 | — | μF |

4.8 Flash

Table 4.8. Flash

| Parameter | Symbol | Test Condition | Min | Typ | Max | Unit |
|---|---------------|---------------------------|-------|------|----------------|---------------|
| Flash erase cycles before failure | EC_{FLASH} | | 20000 | — | — | cycles |
| Flash data retention | RET_{FLASH} | $T_{AMB} < 150\text{ °C}$ | 10000 | — | — | h |
| | | $T_{AMB} < 85\text{ °C}$ | 10 | — | — | years |
| | | $T_{AMB} < 70\text{ °C}$ | 20 | — | — | years |
| Word (32-bit) programming time | t_{W_PROG} | | 20 | — | — | μs |
| Page erase time | t_{PERASE} | | 20 | 20.4 | 20.8 | ms |
| Device erase time | t_{DERASE} | | 40 | 40.8 | 41.6 | ms |
| Erase current | I_{ERASE} | | — | — | 7 ¹ | mA |
| Write current | I_{WRITE} | | — | — | 7 ¹ | mA |
| Supply voltage during flash erase and write | V_{FLASH} | | 1.98 | — | 3.8 | V |
| Note: | | | | | | |
| 1. Measured at 25 °C. | | | | | | |

4.9 General Purpose Input Output

Table 4.9. GPIO

| Parameter | Symbol | Test Condition | Min | Typ | Max | Unit |
|---|------------|---|---------------|---------------|---------------|------|
| Input low voltage | V_{IOIL} | | — | — | $0.30 V_{DD}$ | V |
| Input high voltage | V_{IOIH} | | $0.70 V_{DD}$ | — | — | V |
| Output high voltage (Production test condition = 3.0V, DRIVE-MODE = STANDARD) | V_{IOOH} | Sourcing 0.1 mA, $V_{DD}=1.98$ V, GPIO_Px_CTRL DRIVEMODE = LOWEST | — | $0.80 V_{DD}$ | — | V |
| | | Sourcing 0.1 mA, $V_{DD}=3.0$ V, GPIO_Px_CTRL DRIVEMODE = LOWEST | — | $0.90 V_{DD}$ | — | V |
| | | Sourcing 1 mA, $V_{DD}=1.98$ V, GPIO_Px_CTRL DRIVEMODE = LOW | — | $0.85 V_{DD}$ | — | V |
| | | Sourcing 1 mA, $V_{DD}=3.0$ V, GPIO_Px_CTRL DRIVEMODE = LOW | — | $0.90 V_{DD}$ | — | V |
| | | Sourcing 6 mA, $V_{DD}=1.98$ V, GPIO_Px_CTRL DRIVEMODE = STANDARD | $0.75 V_{DD}$ | — | — | V |
| | | Sourcing 6 mA, $V_{DD}=3.0$ V, GPIO_Px_CTRL DRIVEMODE = STANDARD | $0.85 V_{DD}$ | — | — | V |
| | | Sourcing 20 mA, $V_{DD}=1.98$ V, GPIO_Px_CTRL DRIVEMODE = HIGH | $0.60 V_{DD}$ | — | — | V |
| | | Sourcing 20 mA, $V_{DD}=3.0$ V, GPIO_Px_CTRL DRIVEMODE = HIGH | $0.80 V_{DD}$ | — | — | V |

| Parameter | Symbol | Test Condition | Min | Typ | Max | Unit |
|---|----------------|--|---------------|---------------|---------------|------|
| Output low voltage (Production test condition = 3.0 V, DRIVE-MODE = STANDARD) | V_{IOOL} | Sinking 0.1 mA, $V_{DD}=1.98$ V, GPIO_Px_CTRL DRIVEMODE = LOWEST | — | $0.20 V_{DD}$ | — | V |
| | | Sinking 0.1 mA, $V_{DD}=3.0$ V, GPIO_Px_CTRL DRIVEMODE = LOWEST | — | $0.10 V_{DD}$ | — | V |
| | | Sinking 1 mA, $V_{DD}=1.98$ V, GPIO_Px_CTRL DRIVEMODE = LOW | — | $0.10 V_{DD}$ | — | V |
| | | Sinking 1 mA, $V_{DD}=3.0$ V, GPIO_Px_CTRL DRIVEMODE = LOW | — | $0.05 V_{DD}$ | — | V |
| | | Sinking 6 mA, $V_{DD}=1.98$ V, GPIO_Px_CTRL DRIVEMODE = STANDARD | — | — | $0.30 V_{DD}$ | V |
| | | Sinking 6 mA, $V_{DD}=3.0$ V, GPIO_Px_CTRL DRIVEMODE = STANDARD | — | — | $0.20 V_{DD}$ | V |
| | | Sinking 20 mA, $V_{DD}=1.98$ V, GPIO_Px_CTRL DRIVEMODE = HIGH | — | — | $0.35 V_{DD}$ | V |
| | | Sinking 20 mA, $V_{DD}=3.0$ V, GPIO_Px_CTRL DRIVEMODE = HIGH | — | — | $0.25 V_{DD}$ | V |
| Input leakage current | I_{IOLEAK} | High Impedance IO connected to GROUND or Vdd | — | ± 0.1 | ± 100 | nA |
| I/O pin pull-up resistor | R_{PU} | | — | 40 | — | kOhm |
| I/O pin pull-down resistor | R_{PD} | | — | 40 | — | kOhm |
| Internal ESD series resistor | R_{IOESD} | | — | 200 | — | Ohm |
| Pulse width of pulses to be removed by the glitch suppression filter | $t_{IOGLITCH}$ | | 10 | — | — | ns |
| Output fall time | t_{IOOF} | GPIO_Px_CTRL DRIVEMODE = LOWEST and load capacitance $C_L=12.5-25$ pF. | $20+0.1 C_L$ | — | 250 | ns |
| | | GPIO_Px_CTRL DRIVEMODE = LOW and load capacitance $C_L=350-600$ pF | $20+0.1 C_L$ | — | 250 | ns |
| I/O pin hysteresis ($V_{IOTHR+} - V_{IOTHR-}$) | V_{IOHYST} | $V_{DD} = 1.98 - 3.8$ V | $0.10 V_{DD}$ | — | — | V |



GPIO_Px_CTRL DRIVEMODE = LOWEST



GPIO_Px_CTRL DRIVEMODE = LOW



GPIO_Px_CTRL DRIVEMODE = STANDARD

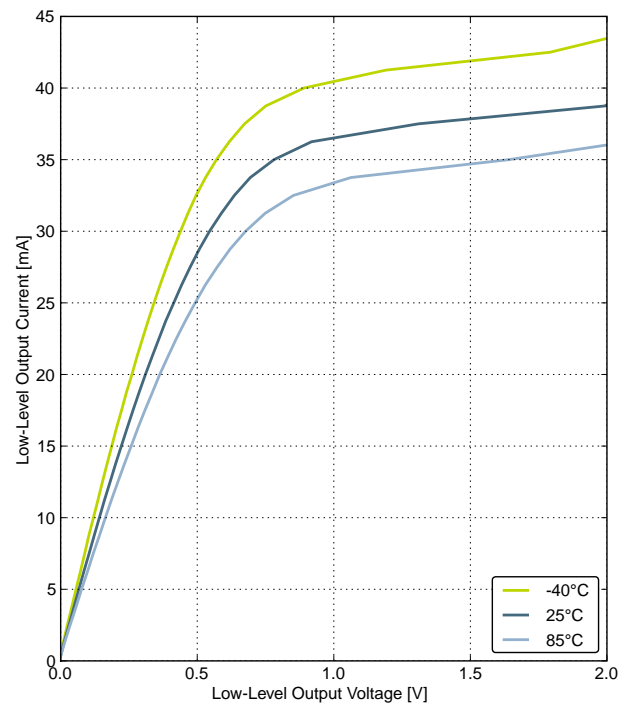

GPIO_Px_CTRL DRIVEMODE = High

Figure 4.1. Typical Low-Level Output Current, 2 V Supply Voltage



GPIO_Px_CTRL DRIVEMODE = LOWEST



GPIO_Px_CTRL DRIVEMODE = LOW



GPIO_Px_CTRL DRIVEMODE = STANDARD



GPIO_Px_CTRL DRIVEMODE = High

Figure 4.2. Typical High-Level Output Current, 2 V Supply Voltage



GPIO_Px_CTRL DRIVEMODE = LOWEST



GPIO_Px_CTRL DRIVEMODE = LOW



GPIO_Px_CTRL DRIVEMODE = STANDARD



GPIO_Px_CTRL DRIVEMODE = High

Figure 4.3. Typical Low-Level Output Current, 3 V Supply Voltage

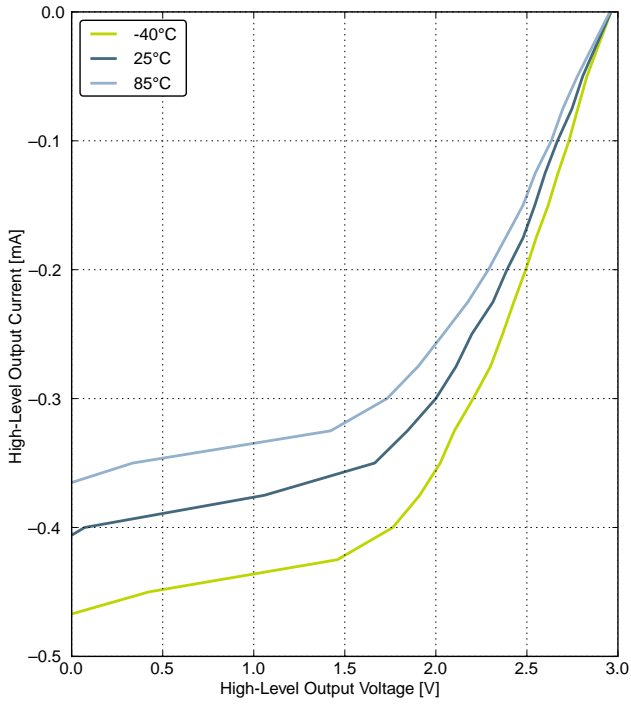

GPIO_Px_CTRL DRIVEMODE = LOWEST

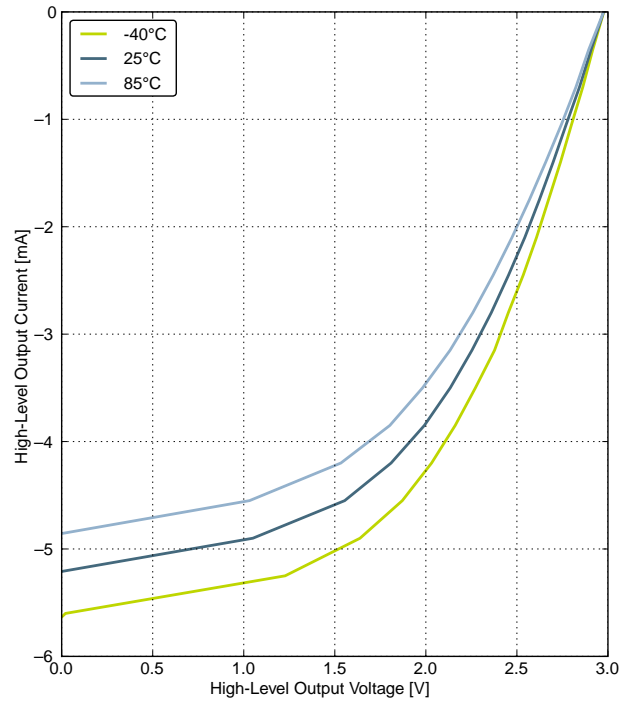

GPIO_Px_CTRL DRIVEMODE = LOW

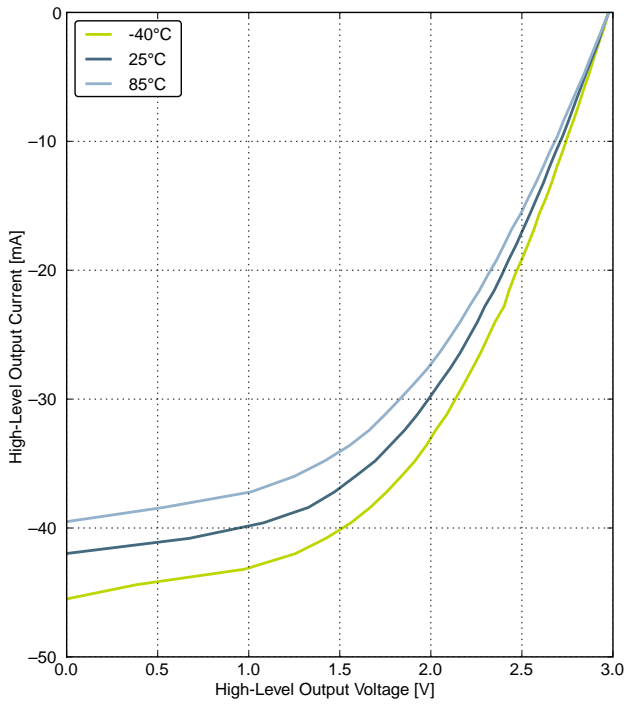

GPIO_Px_CTRL DRIVEMODE = STANDARD

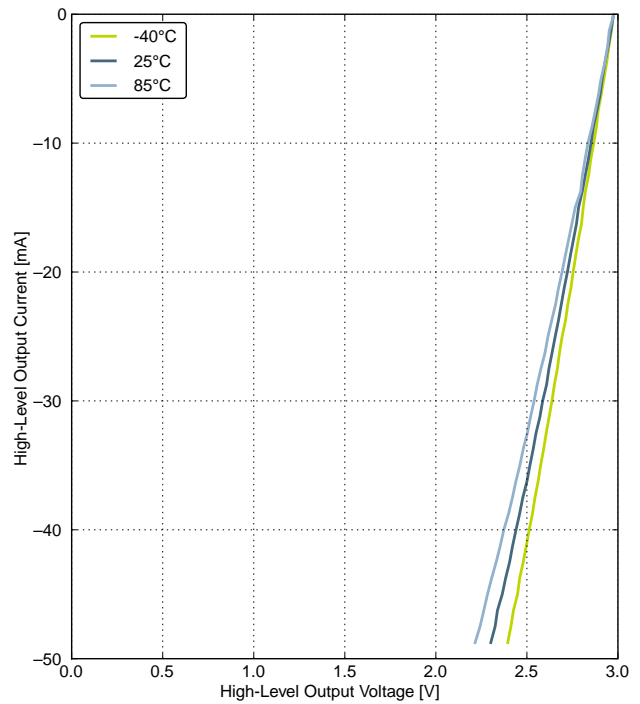

GPIO_Px_CTRL DRIVEMODE = High

Figure 4.4. Typical High-Level Output Current, 3 V Supply Voltage



GPIO_Px_CTRL DRIVEMODE = LOWEST



GPIO_Px_CTRL DRIVEMODE = LOW

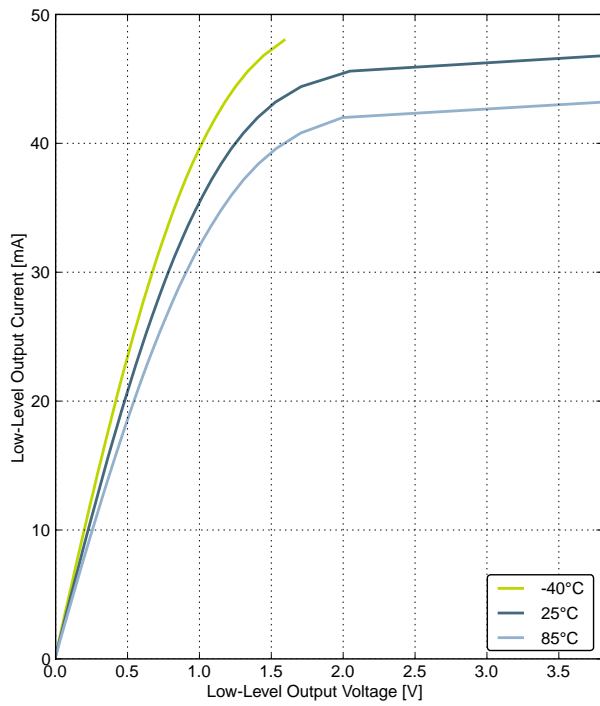

GPIO_Px_CTRL DRIVEMODE = STANDARD

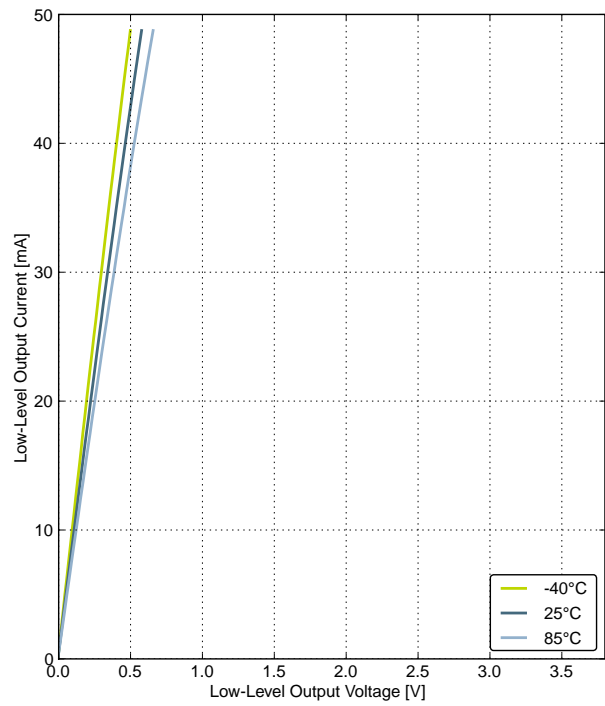

GPIO_Px_CTRL DRIVEMODE = High

Figure 4.5. Typical Low-Level Output Current, 3.8 V Supply Voltage



GPIO_Px_CTRL DRIVEMODE = LOWEST



GPIO_Px_CTRL DRIVEMODE = LOW



GPIO_Px_CTRL DRIVEMODE = STANDARD



GPIO_Px_CTRL DRIVEMODE = High

Figure 4.6. Typical High-Level Output Current, 3.8 V Supply Voltage

4.10 Oscillators

4.10.1 LXFO

Table 4.10. LFXO

| Parameter | Symbol | Test Condition | Min | Typ | Max | Unit |
|---|--------------|---|----------------|--------|------|------------|
| Supported nominal crystal frequency | f_{LFXO} | | — | 32.768 | — | kHz |
| Supported crystal equivalent series resistance (ESR) | ESR_{LFXO} | | — | 30 | 120 | k Ω |
| Supported crystal external load range | C_{LFXOL} | | X ¹ | — | 25 | pF |
| Duty cycle | DC_{LFXO} | | 48 | 50 | 53.5 | % |
| Current consumption for core and buffer after startup | I_{LFXO} | ESR=30 k Ω , C_L =10 pF, LFXO-BOOST in CMU_CTRL is 1 | — | 190 | — | nA |
| Start- up time | t_{LFXO} | ESR=30 k Ω , C_L =10 pF, 40% - 60% duty cycle has been reached, LFXOBOOST in CMU_CTRL is 1 | — | 400 | — | ms |

Note:

1. See Minimum Load Capacitance (C_{LFXOL}) Requirement For Safe Crystal Startup in energyAware Designer in Simplicity Studio.

For safe startup of a given crystal, the energyAware Designer in Simplicity Studio contains a tool to help users configure both load capacitance and software settings for using the LFXO. For details regarding the crystal configuration, the reader is referred to application note AN0016: *EFM32 Oscillator Design Consideration*.

4.10.2 HFXO

Table 4.11. HFXO

| Parameter | Symbol | Test Condition | Min | Typ | Max | Unit |
|--|----------------------------|--|-----|-----|------|---------------|
| Supported nominal crystal Frequency | f_{HFXO} | | 4 | — | 48 | MHz |
| Supported crystal equivalent series resistance (ESR) | ESR_{HFXO} | Crystal frequency 48 MHz | — | — | 50 | Ω |
| | | Crystal frequency 32 MHz | — | 30 | 60 | Ω |
| | | Crystal frequency 4 MHz | — | 400 | 1500 | Ω |
| The transconductance of the HFXO input transistor at crystal startup | g_{mHFXO} | HFXOBOOST in CMU_CTRL equals 0b11 | 20 | — | — | ms |
| Supported crystal external load range | C_{HFXOL} | | 5 | — | 25 | pF |
| Duty cycle | DC_{HFXO} | | 46 | 50 | 54 | % |
| Current consumption for HFXO after startup | I_{HFXO} | 4 MHz: ESR=400 Ohm, $C_L=20$ pF, HFXOBOOST in CMU_CTRL equals 0b11 | — | 85 | — | μA |
| | | 32 MHz: ESR=30 Ohm, $C_L=10$ pF, HFXOBOOST in CMU_CTRL equals 0b11 | — | 165 | — | μA |
| Startup time | t_{HFXO} | 32 MHz: ESR=30 Ohm, $C_L=10$ pF, HFXOBOOST in CMU_CTRL equals 0b11 | — | 400 | — | μs |

4.10.3 LFRCO

Table 4.12. LFRCO

| Parameter | Symbol | Test Condition | Min | Typ | Max | Unit |
|--|----------------------------|----------------|-------|--------|-------|---------|
| Oscillation frequency , $V_{DD}= 3.0$ V, $T_{AMB}=25$ °C | f_{LFRCO} | | 31.29 | 32.768 | 34.28 | kHz |
| Startup time not including software calibration | t_{LFRCO} | | — | 150 | — | μ s |
| Current consumption | I_{LFRCO} | | — | 300 | — | nA |
| Frequency step for LSB change in TUNING value | TUNE-STEP _{LFRCO} | | — | 1.5 | — | % |



Figure 4.7. Calibrated LFRCO Frequency vs Temperature and Supply Voltage

4.10.4 HFRCO

Table 4.13. HFRCO

| Parameter | Symbol | Test Condition | Min | Typ | Max | Unit |
|---|-----------------------------------|-------------------------------------|------|------------------|------|---------------|
| Oscillation frequency, $V_{DD}=3.0\text{ V}$, $T_{AMB}=25\text{ }^{\circ}\text{C}$ | f_{HFRCO} | 28 MHz frequency band | 27.5 | 28.0 | 28.5 | MHz |
| | | 21 MHz frequency band | 20.6 | 21.0 | 21.4 | MHz |
| | | 14 MHz frequency band | 13.7 | 14.0 | 14.3 | MHz |
| | | 11 MHz frequency band | 10.8 | 11.0 | 11.2 | MHz |
| | | 7 MHz frequency band | 6.48 | 6.60 | 6.72 | MHz |
| | | 1 MHz frequency band | 1.15 | 1.20 | 1.25 | MHz |
| Settling time after start-up | $t_{\text{HFRCO_settling}}$ | $f_{\text{HFRCO}} = 14\text{ MHz}$ | — | 0.6 | — | Cycles |
| Current consumption | I_{HFRCO} | $f_{\text{HFRCO}} = 28\text{ MHz}$ | — | 165 | 215 | μA |
| | | $f_{\text{HFRCO}} = 21\text{ MHz}$ | — | 134 | 175 | μA |
| | | $f_{\text{HFRCO}} = 14\text{ MHz}$ | — | 106 | 140 | μA |
| | | $f_{\text{HFRCO}} = 11\text{ MHz}$ | — | 94 | 125 | μA |
| | | $f_{\text{HFRCO}} = 6.6\text{ MHz}$ | — | 77 | 105 | μA |
| | | $f_{\text{HFRCO}} = 1.2\text{ MHz}$ | — | 25 | 40 | μA |
| Duty cycle | DC_{HFRCO} | $f_{\text{HFRCO}} = 14\text{ MHz}$ | 48.5 | 50 | 51 | % |
| Frequency step for LSB change in TUNING value | $\text{TUNE-STEP}_{\text{HFRCO}}$ | | — | 0.3 ¹ | — | % |

Note:

- The TUNING field in the CMU_HFRCOCTRL register may be used to adjust the HFRCO frequency. There is enough adjustment range to ensure that the frequency bands above 7 MHz will always have some overlap across supply voltage and temperature. By using a stable frequency reference such as the LFXO or HFXO, a firmware calibration routine can vary the TUNING bits and the frequency band to maintain the HFRCO frequency at any arbitrary value between 7 MHz and 28 MHz across operating conditions.



Figure 4.8. Calibrated HFRCO 1 MHz Band Frequency vs Supply Voltage and Temperature



Figure 4.9. Calibrated HFRCO 7 MHz Band Frequency vs Supply Voltage and Temperature



Figure 4.10. Calibrated HFRCO 11 MHz Band Frequency vs Supply Voltage and Temperature



Figure 4.11. Calibrated HFRCO 14 MHz Band Frequency vs Supply Voltage and Temperature



Figure 4.12. Calibrated HFRCO 21 MHz Band Frequency vs Supply Voltage and Temperature



Figure 4.13. Calibrated HFRCO 28 MHz Band Frequency vs Supply Voltage and Temperature

4.10.5 AUXHFRCO

Table 4.14. AUXHFRCO

| Parameter | Symbol | Test Condition | Min | Typ | Max | Unit |
|---|--------------------------------------|---------------------------------------|-------------------|-------------------|-------------------|--------|
| Oscillation frequency, $V_{DD}=3.0\text{ V}$, $T_{AMB}=25\text{ }^{\circ}\text{C}$ | f_{AUXHFRCO} | 28 MHz frequency band | 27.5 | 28.0 | 28.5 | MHz |
| | | 21 MHz frequency band | 20.6 | 21.0 | 21.4 | MHz |
| | | 14 MHz frequency band | 13.7 | 14.0 | 14.3 | MHz |
| | | 11 MHz frequency band | 10.8 | 11.0 | 11.2 | MHz |
| | | 7 MHz frequency band | 6.48 ¹ | 6.60 ¹ | 6.72 ¹ | MHz |
| | | 1 MHz frequency band | 1.15 ² | 1.20 ² | 1.25 ² | MHz |
| Settling time after start-up | $t_{\text{AUXHFRCO_settling}}$ | $f_{\text{AUXHFRCO}} = 14\text{ MHz}$ | — | 0.6 | — | Cycles |
| Frequency step for LSB change in TUNING value | $\text{TUNE-STEP}_{\text{AUXHFRCO}}$ | | — | 0.3 ³ | — | % |

Note:

1. For devices with prod. rev. < 19, Typ = 7 MHz and Min/Max values not applicable.
2. For devices with prod. rev. < 19, Typ = 1 MHz and Min/Max values not applicable.
3. The TUNING field in the CMU_AUXHFRCOCTRL register may be used to adjust the AUXHFRCO frequency. There is enough adjustment range to ensure that the frequency bands above 7 MHz will always have some overlap across supply voltage and temperature. By using a stable frequency reference such as the LFXO or HFXO, a firmware calibration routine can vary the TUNING bits and the frequency band to maintain the AUXHFRCO frequency at any arbitrary value between 7 MHz and 28 MHz across operating conditions.

4.10.6 ULFRCO

Table 4.15. ULFRCO

| Parameter | Symbol | Test Condition | Min | Typ | Max | Unit |
|----------------------------|----------------------|----------------|-----|-------|------|------|
| Oscillation frequency | f_{ULFRCO} | 25 °C, 3 V | 0.7 | | 1.75 | kHz |
| Temperature coefficient | TC_{ULFRCO} | | — | 0.05 | — | %/°C |
| Supply voltage coefficient | VC_{ULFRCO} | | — | -18.2 | — | %/V |

4.11 Analog Digital Converter (ADC)

Table 4.16. ADC

| Parameter | Symbol | Test Condition | Min | Typ | Max | Unit |
|--|----------------------------|--|---------------------|------|-----------------------|---------------|
| Input voltage range | V_{ADCIN} | Single ended | 0 | — | V_{REF} | V |
| | | Differential | $-V_{\text{REF}}/2$ | — | $V_{\text{REF}}/2$ | V |
| Input range of external reference voltage, single ended and differential | V_{ADCREFIN} | | 1.25 | — | V_{DD} | V |
| Input range of external negative reference voltage on channel 7 | $V_{\text{ADCREFIN_CH7}}$ | See V_{ADCREFIN} | 0 | — | $V_{\text{DD}} - 1.1$ | V |
| Input range of external positive reference voltage on channel 6 | $V_{\text{ADCREFIN_CH6}}$ | See V_{ADCREFIN} | 0.625 | — | V_{DD} | V |
| Common mode input range | V_{ADCCMIN} | | 0 | — | V_{DD} | V |
| Input current | I_{ADCIN} | 2 pF sampling capacitors | — | <100 | — | nA |
| Analog input common mode rejection ratio | CMRR_{ADC} | | — | 65 | — | dB |
| Average active current | I_{ADC} | 1 MSamples/s, 12 bit, external reference | — | 351 | — | μA |
| | | 10 kSamples/s 12 bit, internal 1.25 V reference, WARMUPMODE in ADCn_CTRL set to 0b00 | — | 67 | — | μA |
| | | 10 kSamples/s 12 bit, internal 1.25 V reference, WARMUPMODE in ADCn_CTRL set to 0b01 | — | 63 | — | μA |
| | | 10 kSamples/s 12 bit, internal 1.25 V reference, WARMUPMODE in ADCn_CTRL set to 0b10 | — | 64 | — | μA |
| Current consumption of internal voltage reference | I_{ADCREF} | Internal voltage reference | — | 65 | — | μA |
| Input capacitance | C_{ADCIN} | | — | 2 | — | pF |
| Input ON resistance | R_{ADCIN} | | 1 | — | — | MOhm |
| Input RC filter resistance | R_{ADCFILT} | | — | 10 | — | kOhm |
| Input RC filter/decoupling capacitance | C_{ADCFILT} | | — | 250 | — | fF |
| ADC Clock Frequency | f_{ADCCLK} | | — | — | 13 | MHz |
| Conversion time | t_{ADCCONV} | 6 bit | 7 | — | — | ADCCLK Cycles |
| | | 8 bit | 11 | — | — | ADCCLK Cycles |
| | | 12 bit | 13 | — | — | ADCCLK Cycles |
| Acquisition time | t_{ADCACQ} | Programmable | 1 | — | 256 | ADCCLK Cycles |

| Parameter | Symbol | Test Condition | Min | Typ | Max | Unit |
|---|-----------------------|---|-----|-----|-----|---------|
| Required acquisition time for VDD/3 reference | t_{AD-} CACQVDD3 | | 2 | — | — | μ s |
| Startup time of reference generator and ADC core in NORMAL mode | $t_{ADCSTART}$ | | — | 5 | — | μ s |
| Startup time of reference generator and ADC core in KEEP-ADCWARM mode | | | — | 1 | — | μ s |
| Signal to Noise Ratio (SNR) | SNR_{ADC} | 1 MSamples/s, 12 bit, single ended, internal 1.25 V reference | — | 59 | — | dB |
| | | 1 MSamples/s, 12 bit, single ended, internal 2.5 V reference | — | 63 | — | dB |
| | | 1 MSamples/s, 12 bit, single ended, V_{DD} reference | — | 65 | — | dB |
| | | 1 MSamples/s, 12 bit, differential, internal 1.25 V reference | — | 60 | — | dB |
| | | 1 MSamples/s, 12 bit, differential, internal 2.5 V reference | — | 65 | — | dB |
| | | 1 MSamples/s, 12 bit, differential, 5 V reference | — | 54 | — | dB |
| | | 1 MSamples/s, 12 bit, differential, V_{DD} reference | — | 67 | — | dB |
| | | 1 MSamples/s, 12 bit, differential, $2xV_{DD}$ reference | — | 69 | — | dB |
| | | 200 kSamples/s, 12 bit, single ended, internal 1.25V reference | — | 62 | — | dB |
| | | 200 kSamples/s, 12 bit, single ended, internal 2.5 V reference | — | 63 | — | dB |
| | | 200 kSamples/s, 12 bit, single ended, V_{DD} reference | — | 67 | — | dB |
| | | 200 kSamples/s, 12 bit, differential, internal 1.25 V reference | — | 63 | — | dB |
| | | 200 kSamples/s, 12 bit, differential, internal 2.5 V reference | — | 66 | — | dB |
| | | 200 kSamples/s, 12 bit, differential, 5 V reference | — | 66 | — | dB |
| | | 200 kSamples/s, 12 bit, differential, V_{DD} reference | 63 | 66 | — | dB |
| | | 200 kSamples/s, 12 bit, differential, $2xV_{DD}$ reference | — | 70 | — | dB |

| Parameter | Symbol | Test Condition | Min | Typ | Max | Unit |
|--|----------------------|---|-----|-----|-----|------|
| Signal-to-Noise And Distortion-ratio (SINAD) | SINAD _{ADC} | 1 MSamples/s, 12 bit, single ended, internal 1.25 V reference | — | 58 | — | dB |
| | | 1 MSamples/s, 12 bit, single ended, internal 2.5 V reference | — | 62 | — | dB |
| | | 1 MSamples/s, 12 bit, single ended, V _{DD} reference | — | 64 | — | dB |
| | | 1 MSamples/s, 12 bit, differential, internal 1.25 V reference | — | 60 | — | dB |
| | | 1 MSamples/s, 12 bit, differential, internal 2.5 V reference | — | 64 | — | dB |
| | | 1 MSamples/s, 12 bit, differential, 5V reference | — | 54 | — | dB |
| | | 1 MSamples/s, 12 bit, differential, V _{DD} reference | — | 66 | — | dB |
| | | 1 MSamples/s, 12 bit, differential, 2xV _{DD} reference | — | 68 | — | dB |
| | | 200 kSamples/s, 12 bit, single ended, internal 1.25 V reference | — | 61 | — | dB |
| | | 200 kSamples/s, 12 bit, single ended, internal 2.5 V reference | — | 65 | — | dB |
| | | 200 kSamples/s, 12 bit, single ended, V _{DD} reference | — | 66 | — | dB |
| | | 200 kSamples/s, 12 bit, differential, internal 1.25 V reference | — | 63 | — | dB |
| | | 200 kSamples/s, 12 bit, differential, internal 2.5 V reference | — | 66 | — | dB |
| | | 200 kSamples/s, 12 bit, differential, 5V reference | — | 66 | — | dB |
| | | 200 kSamples/s, 12 bit, differential, V _{DD} reference | 62 | 66 | — | dB |
| | | 200 kSamples/s, 12 bit, differential, 2xV _{DD} reference | — | 69 | — | dB |

| Parameter | Symbol | Test Condition | Min | Typ | Max | Unit |
|--|-------------------------|---|---------------------|-------------------|--------------------|--------------|
| Spurious-Free Dynamic Range (SFDR) | SFDR _{ADC} | 1 MSamples/s, 12 bit, single ended, internal 1.25 V reference | — | 64 | — | dBc |
| | | 1 MSamples/s, 12 bit, single ended, internal 2.5 V reference | — | 76 | — | dBc |
| | | 1 MSamples/s, 12 bit, single ended, V _{DD} reference | — | 73 | — | dBc |
| | | 1 MSamples/s, 12 bit, differential, internal 1.25 V reference | — | 66 | — | dBc |
| | | 1 MSamples/s, 12 bit, differential, internal 2.5 V reference | — | 77 | — | dBc |
| | | 1 MSamples/s, 12 bit, differential, V _{DD} reference | — | 76 | — | dBc |
| | | 1 MSamples/s, 12 bit, differential, 2xV _{DD} reference | — | 75 | — | dBc |
| | | 1 MSamples/s, 12 bit, differential, 5V reference | — | 69 | — | dBc |
| | | 200 kSamples/s, 12 bit, single ended, internal 1.25 V reference | — | 75 | — | dBc |
| | | 200 kSamples/s, 12 bit, single ended, internal 2.5 V reference | — | 75 | — | dBc |
| | | 200 kSamples/s, 12 bit, single ended, V _{DD} reference | — | 76 | — | dBc |
| | | 200 kSamples/s, 12 bit, differential, internal 1.25 V reference | — | 79 | — | dBc |
| | | 200 kSamples/s, 12 bit, differential, internal 2.5 V reference | — | 79 | — | dBc |
| | | 200 kSamples/s, 12 bit, differential, 5 V reference | — | 78 | — | dBc |
| | | 200 kSamples/s, 12 bit, differential, V _{DD} reference | 68 | 79 | — | dBc |
| | | 200 kSamples/s, 12 bit, differential, 2xV _{DD} reference | — | 79 | — | dBc |
| Offset voltage | V _{ADCOFF-SET} | After calibration, single ended | -3.5 | 0.3 | 3 | mV |
| | | After calibration, differential | — | 0.3 | — | mV |
| Thermometer output gradient | TGRAD _{ADCTH} | | — | -1.92 | — | mV/°C |
| | | | — | -6.3 | — | ADC Codes/°C |
| Differential non-linearity (DNL) | DNL _{ADC} | | -1 | ±0.7 | 4 | LSB |
| Integral non-linearity (INL), End point method | INL _{ADC} | | — | ±1.2 | ±3 | LSB |
| No missing codes | MC _{ADC} | | 11.999 ¹ | 12 | — | bits |
| Gain error drift | GAIN _{ED} | 1.25 V reference | — | 0.01 ² | 0.033 ³ | %/°C |
| | | 2.5 V reference | — | 0.01 ² | 0.03 ³ | %/°C |

| Parameter | Symbol | Test Condition | Min | Typ | Max | Unit |
|--------------------|----------------------|------------------|-----|------------------|-------------------|--------|
| Offset error drift | OFFSET _{ED} | 1.25 V reference | – | 0.2 ² | 0.7 ³ | LSB/°C |
| | | 2.5 V reference | – | 0.2 ² | 0.62 ³ | LSB/°C |

Note:

1. On the average every ADC will have one missing code, most likely to appear around 2048 +/- n*512 where n can be a value in the set {-3, -2, -1, 1, 2, 3}. There will be no missing code around 2048, and in spite of the missing code the ADC will be monotonic at all times so that a response to a slowly increasing input will always be a slowly increasing output. Around the one code that is missing, the neighbour codes will look wider in the DNL plot. The spectra will show spurs on the level of -78 dBc for a full scale input for chips that have the missing code issue.
2. Typical numbers given by $\text{abs}(\text{Mean}) / (85 - 25)$.
3. Max number given by $(\text{abs}(\text{Mean}) + 3 \times \text{stddev}) / (85 - 25)$.

The integral non-linearity (INL) and differential non-linearity parameters are explained in Figure 3.14 (p. 33) and Figure 3.15 (p. 33), respectively.



Figure 4.14. Integral Non-Linearity (INL)



Figure 4.15. Differential Non-Linearity (DNL)

4.11.1 Typical Performance



1.25V Reference



2.5V Reference



2XVDDVSS Reference



5VDIFF Reference



V_{DD} Reference

Figure 4.16. ADC Frequency Spectrum, $V_{DD} = 3\text{ V}$, Temp = 25 °C



1.25V Reference



2.5V Reference



2XVDDVSS Reference



5VDIFF Reference



VDD Reference

Figure 4.17. ADC Integral Linearity Error vs Code, $V_{DD} = 3\text{ V}$, Temp = 25 °C



1.25V Reference



2.5V Reference



2XVDDVSS Reference



5VDIFF Reference



V_{DD} Reference

Figure 4.18. ADC Differential Linearity Error vs Code, V_{DD} = 3 V, Temp = 25 °C



Offset vs Supply Voltage, Temp = 25 °C

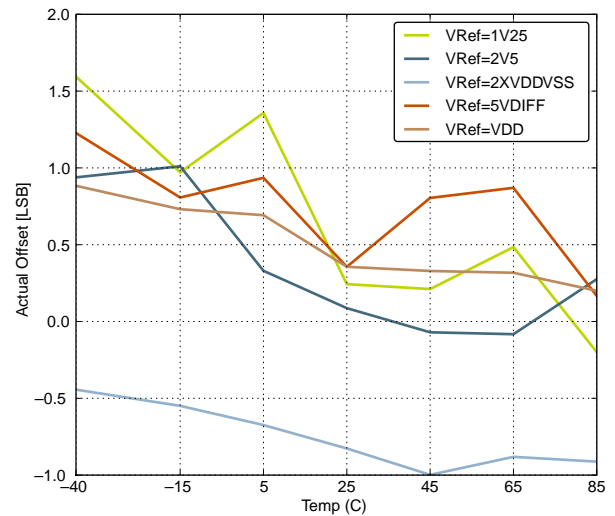

Offset vs Temperature, V_{DD} = 3 V

Figure 4.19. ADC Absolute Offset, Common Mode = V_{DD}/2



Signal to Noise Ratio (SNR)



Spurious-Free Dynamic Range (SFDR)

Figure 4.20. ADC Dynamic Performance vs Temperature for all ADC References, $V_{DD} = 3\text{ V}$



Figure 4.21. ADC Temperature Sensor Readout

4.12 Digital Analog Converter (DAC)

Table 4.17. DAC

| Parameter | Symbol | Test Condition | Min | Typ | Max | Unit |
|--|------------------|---|-----------|------------------|----------|------------|
| Output voltage range | V_{DACOUT} | VDD voltage reference, single ended | 0 | — | V_{DD} | V |
| | | VDD voltage reference, differential | $-V_{DD}$ | — | V_{DD} | V |
| Output common mode voltage range | V_{DACCM} | | 0 | — | V_{DD} | V |
| Active current including references for 2 channels | I_{DAC} | 500 kSamples/s, 12 bit | — | 400 ¹ | — | μA |
| | | 100 kSamples/s, 12 bit | — | 200 | — | μA |
| | | 1 kSamples/s 12 bit NORMAL | — | 17 | — | μA |
| Sample rate | SR_{DAC} | | — | — | 500 | ksamples/s |
| DAC clock frequency | f_{DAC} | Continuous Mode | — | — | 1000 | kHz |
| | | Sample/Hold Mode | — | — | 250 | kHz |
| | | Sample/Off Mode | — | — | 250 | kHz |
| Clock cycles per conversion | $CYC_{DAC-CONV}$ | | — | 2 | — | |
| Conversion time | $t_{DACCONV}$ | | 2 | — | — | μs |
| Settling time | $t_{DACSETTLE}$ | | — | 5 | — | μs |
| Signal to Noise Ratio (SNR) | SNR_{DAC} | 500 kSamples/s, 12 bit, single ended, internal 1.25 V reference | — | 58 | — | dB |
| | | 500 kSamples/s, 12 bit, single ended, internal 2.5 V reference | — | 59 | — | dB |
| | | 500 kSamples/s, 12 bit, differential, internal 1.25 V reference | — | 58 | — | dB |
| | | 500 kSamples/s, 12 bit, differential, internal 2.5 V reference | — | 58 | — | dB |
| | | 500 kSamples/s, 12 bit, differential, V_{DD} reference | — | 59 | — | dB |
| Signal to Noise-pulse Distortion Ratio (SNDR) | $SNDR_{DAC}$ | 500 kSamples/s, 12 bit, single ended, internal 1.25 V reference | — | 57 | — | dB |
| | | 500 kSamples/s, 12 bit, single ended, internal 2.5 V reference | — | 54 | — | dB |
| | | 500 kSamples/s, 12 bit, differential, internal 1.25 V reference | — | 56 | — | dB |
| | | 500 kSamples/s, 12 bit, differential, internal 2.5 V reference | — | 53 | — | dB |
| | | 500 kSamples/s, 12 bit, differential, V_{DD} reference | — | 55 | — | dB |

| Parameter | Symbol | Test Condition | Min | Typ | Max | Unit |
|--|-------------------------|---|-----|-----|-----|------|
| Spurious-Free Dynamic Range(SFDR) | SFDR _{DAC} | 500 kSamples/s, 12 bit, single ended, internal 1.25 V reference | — | 62 | — | dBc |
| | | 500 kSamples/s, 12 bit, single ended, internal 2.5 V reference | — | 56 | — | dBc |
| | | 500 kSamples/s, 12 bit, differential, internal 1.25 V reference | — | 61 | — | dBc |
| | | 500 kSamples/s, 12 bit, differential, internal 2.5 V reference | — | 55 | — | dBc |
| | | 500 kSamples/s, 12 bit, differential, V _{DD} reference | — | 60 | — | dBc |
| Offset voltage | V _{DACOFF-SET} | After calibration, single ended | — | 2 | 9 | mV |
| | | After calibration, differential | — | 2 | — | mV |
| Differential non-linearity | DNL _{DAC} | | — | ±1 | — | LSB |
| Integral non-linearity | INL _{DAC} | | — | ±5 | — | LSB |
| No missing codes | MC _{DAC} | | — | 12 | — | bits |
| Note: | | | | | | |
| 1. Measured with a static input code and no loading on the output. | | | | | | |

4.13 Operational Amplifier (OPAMP)

The electrical characteristics for the Operational Amplifiers are based on simulations.

Table 4.18. OPAMP

| Parameter | Symbol | Test Condition | Min | Typ | Max | Unit |
|----------------------------|---------------------------|---|-----------------|------|----------------------|-------|
| Active Current | I _{OPAMP} | (OPA2)BIASPROG=0xF, (OPA2)HALFBIAS=0x0, Unity Gain | — | 370 | 460 | μA |
| | | (OPA2)BIASPROG=0x7, (OPA2)HALFBIAS=0x1, Unity Gain | — | 95 | 135 | μA |
| | | (OPA2)BIASPROG=0x0, (OPA2)HALFBIAS=0x1, Unity Gain | — | 13 | 25 | μA |
| Open Loop Gain | G _{OL} | (OPA2)BIASPROG=0xF, (OPA2)HALFBIAS=0x0 | — | 101 | — | dB |
| | | (OPA2)BIASPROG=0x7, (OPA2)HALFBIAS=0x1 | — | 98 | — | dB |
| | | (OPA2)BIASPROG=0x0, (OPA2)HALFBIAS=0x1 | — | 91 | — | dB |
| Gain Bandwidth Product | GBW _{OPAMP} | (OPA2)BIASPROG=0xF, (OPA2)HALFBIAS=0x0 | — | 6.1 | — | MHz |
| | | (OPA2)BIASPROG=0x7, (OPA2)HALFBIAS=0x1 | — | 1.8 | — | MHz |
| | | (OPA2)BIASPROG=0x0, (OPA2)HALFBIAS=0x1 | — | 0.25 | — | MHz |
| Phase Margin | PM _{OPAMP} | (OPA2)BIASPROG=0xF, (OPA2)HALFBIAS=0x0, C _L =75 pF | — | 64 | — | ° |
| | | (OPA2)BIASPROG=0x7, (OPA2)HALFBIAS=0x1, C _L =75 pF | — | 58 | — | ° |
| | | (OPA2)BIASPROG=0x0, (OPA2)HALFBIAS=0x1, C _L =75 pF | — | 58 | — | ° |
| Input Resistance | R _{INPUT} | | — | 100 | — | MΩ |
| Load Resistance | R _{LOAD} | | 200 | — | — | Ω |
| DC Load Current | I _{LOAD_DC} | | — | — | 11 | mA |
| Input Voltage | V _{INPUT} | OPAxHCMDIS=0 | V _{SS} | — | V _{DD} | V |
| | | OPAxHCMDIS=1 | V _{SS} | — | V _{DD} -1.2 | V |
| Output Voltage | V _{OUTPUT} | | V _{SS} | — | V _{DD} | V |
| Input Offset Voltage | V _{OFFSET} | Unity Gain, V _{SS} <V _{in} <V _{DD} , OPAxHCMDIS=0 | -13 | 0 | 11 | mV |
| | | Unity Gain, V _{SS} <V _{in} <V _{DD} -1.2, OPAxHCMDIS=1 | — | 1 | — | mV |
| Input Offset Voltage Drift | V _{OFFSET_DRIFT} | | — | — | 0.02 | mV/°C |

| Parameter | Symbol | Test Condition | Min | Typ | Max | Unit |
|---------------|---------------------|--|-----|------|-----|-------------------|
| Slew Rate | SR _{OPAMP} | (OPA2)BIASPROG=0xF, (OPA2)HALFBIAS=0x0 | — | 3.2 | — | V/μs |
| | | (OPA2)BIASPROG=0x7, (OPA2)HALFBIAS=0x1 | — | 0.8 | — | V/μs |
| | | (OPA2)BIASPROG=0x0, (OPA2)HALFBIAS=0x1 | — | 0.1 | — | V/μs |
| Voltage Noise | N _{OPAMP} | V _{out} =1 V, RESSEL=0, 0.1 Hz<f<10 kHz, OPAxHCMDIS=0 | — | 101 | — | μV _{RMS} |
| | | V _{out} =1 V, RESSEL=0, 0.1 Hz<f<10 kHz, OPAxHCMDIS=1 | — | 141 | — | μV _{RMS} |
| | | V _{out} =1 V, RESSEL=0, 0.1 Hz<f<1 MHz, OPAxHCMDIS=0 | — | 196 | — | μV _{RMS} |
| | | V _{out} =1 V, RESSEL=0, 0.1 Hz<f<1 MHz, OPAxHCMDIS=1 | — | 229 | — | μV _{RMS} |
| | | RESSEL=7, 0.1 Hz<f<10 kHz, OPAxHCMDIS=0 | — | 1230 | — | μV _{RMS} |
| | | RESSEL=7, 0.1 Hz<f<10 kHz, OPAxHCMDIS=1 | — | 2130 | — | μV _{RMS} |
| | | RESSEL=7, 0.1 Hz<f<1 MHz, OPAxHCMDIS=0 | — | 1630 | — | μV _{RMS} |
| | | RESSEL=7, 0.1 Hz<f<1 MHz, OPAxHCMDIS=1 | — | 2590 | — | μV _{RMS} |



Figure 4.22. OPAMP Common Mode Rejection Ratio



Figure 4.23. OPAMP Positive Power Supply Rejection Ratio



Figure 4.24. OPAMP Negative Power Supply Rejection Ratio



Figure 4.25. OPAMP Voltage Noise Spectral Density (Unity Gain) $V_{out} = 1\text{ V}$



Figure 4.26. OPAMP Voltage Noise Spectral Density (Non-Unity Gain)

4.14 Analog Comparator (ACMP)

Table 4.19. ACMP

| Parameter | Symbol | Test Condition | Min | Typ | Max | Unit |
|---|------------------|---|-----|------|----------|------------|
| Input voltage range | V_{ACMPIN} | | 0 | — | V_{DD} | V |
| ACMP Common Mode voltage range | V_{ACMPCM} | | 0 | — | V_{DD} | V |
| Active current | I_{ACMP} | BIASPROG=0b0000, FULL-BIAS=0 and HALFBIAS=1 in ACMPn_CTRL register | — | 0.1 | 0.4 | μA |
| | $I_{ACMPREF}$ | BIASPROG=0b1111, FULL-BIAS=0 and HALFBIAS=0 in ACMPn_CTRL register | — | 2.87 | 15 | μA |
| | $V_{ACMPOFFSET}$ | BIASPROG=0b1111, FULL-BIAS=1 and HALFBIAS=0 in ACMPn_CTRL register | — | 195 | 520 | μA |
| Current consumption of internal voltage reference | $V_{ACMPHYST}$ | Internal voltage reference off. Using external voltage reference | — | 0 | — | μA |
| | R_{CSRES} | Internal voltage reference | — | 5 | — | μA |
| Offset voltage | $t_{ACMPSTART}$ | BIASPROG= 0b1010, FULL-BIAS=0 and HALFBIAS=0 in ACMPn_CTRL register | -12 | 0 | 12 | mV |
| ACMP hysteresis | | Programmable | — | 17 | — | mV |
| Capacitive Sense Internal Resistance | | CSRESSEL=0b00 in ACMPn_IN-PUTSEL | — | 39 | — | k Ω |
| | | CSRESSEL=0b01 in ACMPn_IN-PUTSEL | — | 71 | — | k Ω |
| | | CSRESSEL=0b10 in ACMPn_IN-PUTSEL | — | 104 | — | k Ω |
| | | CSRESSEL=0b11 in ACMPn_IN-PUTSEL | — | 136 | — | k Ω |
| Startup time | | | — | — | 10 | μs |

The total ACMP current is the sum of the contributions from the ACMP and its internal voltage reference as given below. $I_{ACMPREF}$ is zero if an external voltage reference is used: $I_{ACMPTOTAL} = I_{ACMP} + I_{ACMPREF}$



Current Consumption, HYSTEL = 4



Response Time



Hysteresis

Figure 4.27. CMP Characteristics, Vdd = 3 V, Temp = 25 °C, FULLBIAS = 0, HALFBIAS = 1

4.15 Voltage Comparator (VCMP)

Table 4.20. VCMP

| Parameter | Symbol | Test Condition | Min | Typ | Max | Unit |
|----------------------------------|------------------|--|-----|----------|-----|---------|
| Input voltage range | V_{VCMPIN} | | — | V_{DD} | — | V |
| VCMP Common Mode voltage range | V_{VCMPCM} | | — | V_{DD} | — | V |
| Active current | I_{VCMP} | BIASPROG=0b0000 and HALF-BIAS=1 in VCMPn_CTRL register | — | 0.3 | 0.6 | μA |
| | | BIASPROG=0b1111 and HALF-BIAS=0 in VCMPn_CTRL register. LPREF=0. | — | 22 | 35 | μA |
| Startup time reference generator | $t_{VCMPREF}$ | NORMAL | — | 10 | — | μs |
| Offset voltage | $V_{VCMPOFFSET}$ | Single ended | — | 10 | — | mV |
| | | Differential | — | 10 | — | mV |
| VCMP hysteresis | $V_{VCMPHYST}$ | | — | 61 | 210 | mV |
| Startup time | $t_{VCMPSTART}$ | | — | — | 10 | μs |

The V_{DD} trigger level can be configured by setting the TRIGLEVEL field of the VCMP_CTRL register in accordance with the following equation: $V_{DD} \text{ Trigger Level} = 1.667 V + 0.034 \times \text{TRIGLEVEL}$

4.16 I2C

Table 4.21. I2C Standard-Mode (Sm)

| Parameter | Symbol | Min | Typ | Max | Unit |
|--|--------------|-----|-----|----------------------|---------|
| SCL clock frequency | f_{SCL} | 0 | — | 100 ¹ | kHz |
| SCL clock low time | t_{LOW} | 4.7 | — | — | μ s |
| SCL clock high time | t_{HIGH} | 4.0 | — | — | μ s |
| SDA set-up time | $t_{SU,DAT}$ | 250 | — | — | ns |
| SDA hold time | $t_{HD,DAT}$ | 8 | — | 3450 ^{2, 3} | ns |
| Repeated START condition set-up time | $t_{SU,STA}$ | 4.7 | — | — | μ s |
| (Repeated) START condition hold time | $t_{HD,STA}$ | 4.0 | — | — | μ s |
| STOP condition set-up time | $t_{SU,STO}$ | 4.0 | — | — | μ s |
| Bus free time between a STOP and a START condition | t_{BUF} | 4.7 | — | — | μ s |

Note:

1. For the minimum HPPERCLK frequency required in Standard-mode, see the I2C chapter in the *EZR32LG Reference Manual*.
2. The maximum SDA hold time ($t_{HD,DAT}$) needs to be met only when the device does not stretch the low time of SCL (t_{LOW}).
3. When transmitting data, this number is guaranteed only when $I2Cn_CLKDIV < ((3450 * 10^{-9} [s] * f_{HPPERCLK} [Hz]) - 4)$.

Table 4.22. I2C Fast-Mode (Fm)

| Parameter | Symbol | Min | Typ | Max | Unit |
|--|--------------|-----|-----|---------------------|---------|
| SCL clock frequency | f_{SCL} | 0 | — | 400 ¹ | kHz |
| SCL clock low time | t_{LOW} | 1.3 | — | — | μ s |
| SCL clock high time | t_{HIGH} | 0.6 | — | — | μ s |
| SDA set-up time | $t_{SU,DAT}$ | 100 | — | — | ns |
| SDA hold time | $t_{HD,DAT}$ | 8 | — | 900 ^{2, 3} | ns |
| Repeated START condition set-up time | $t_{SU,STA}$ | 0.6 | — | — | μ s |
| (Repeated) START condition hold time | $t_{HD,STA}$ | 0.6 | — | — | μ s |
| STOP condition set-up time | $t_{SU,STO}$ | 0.6 | — | — | μ s |
| Bus free time between a STOP and a START condition | t_{BUF} | 1.3 | — | — | μ s |

Note:

1. For the minimum HPPERCLK frequency required in Fast-mode, see the I2C chapter in the *EZR32LG Reference Manual*.
2. The maximum SDA hold time ($t_{HD,DAT}$) needs to be met only when the device does not stretch the low time of SCL (t_{LOW}).
3. When transmitting data, this number is guaranteed only when $I2Cn_CLKDIV < ((900 * 10^{-9} [s] * f_{HPPERCLK} [Hz]) - 4)$.

Table 4.23. I2C Fast-mode Plus (Fm+)

| Parameter | Symbol | Min | Typ | Max | Unit |
|--|--------------|------|-----|-------------------|---------|
| SCL clock frequency | f_{SCL} | 0 | — | 1000 ¹ | kHz |
| SCL clock low time | t_{LOW} | 0.5 | — | — | μ s |
| SCL clock high time | t_{HIGH} | 0.26 | — | — | μ s |
| SDA set-up time | $t_{SU,DAT}$ | 50 | — | — | ns |
| SDA hold time | $t_{HD,DAT}$ | 8 | — | — | ns |
| Repeated START condition set-up time | $t_{SU,STA}$ | 0.26 | — | — | μ s |
| (Repeated) START condition hold time | $t_{HD,STA}$ | 0.26 | — | — | μ s |
| STOP condition set-up time | $t_{SU,STO}$ | 0.26 | — | — | μ s |
| Bus free time between a STOP and a START condition | t_{BUF} | 0.5 | — | — | μ s |

Note:

1. For the minimum HPPERCLK frequency required in Fast-mode Plus, see the I2C chapter in the *EZR32LG Reference Manual*.

4.17 Radio

All minimum and maximum values are guaranteed across the recommended operating conditions of supply voltage and from -40 to $+85$ °C unless otherwise stated. All typical values apply at $V_{DD} = 3.3$ V and 25 °C unless otherwise stated. The data was collected while running off the internal RC oscillator (HFRCO).

4.17.1 EZRadioPRO (R6x) DC Electrical Characteristics

Measured on direct-tie RF evaluation board.

Table 4.24. EZRadioPro DC Characteristics

| Parameter | Symbol | Test Condition | Min | Typ | Max | Unit |
|-----------------------------|-------------------------|---|-----|------|-------|---------------|
| Power Saving Modes | I_{shutdown} | RC Oscillator, Main Digital Regulator, and Low Power Digital Regulator OFF | — | 30 | 4000 | nA |
| | I_{standby} | Register values maintained and RC oscillator/WUT OFF | — | 40 | 9000 | nA |
| | I_{SleepRC} | RC Oscillator, Main Digital Regulator, and Low Power Digital Regulator OFF | — | 740 | 10000 | nA |
| | I_{SleepXO} | Sleep current using an external 32 kHz crystal | — | 1.7 | — | μA |
| | $I_{\text{Sensor-LBD}}$ | Low battery detector ON, register values maintained, and all other blocks OFF | — | 1 | — | μA |
| | I_{Ready} | Crystal Oscillator and Main Digital Regulator ON, all other blocks OFF | — | 1.8 | — | mA |
| Preamble Sense Mode Current | I_{psm} | Duty cycling during preamble search, 1.2 kbps, 4 byte preamble | — | 6 | — | mA |
| | | Fixed 1s wakeup interval, 50 kbps, 5 byte preamble | — | 10 | — | μA |
| TUNE Mode Current | I_{TuneRX} | RX Tune, High Performance Mode | — | 7.6 | — | mA |
| | I_{TuneTX} | TX Tune, High Performance Mode | — | 7.8 | — | mA |
| RX Mode Current | I_{RXH} | High Performance Mode, 868 MHz, 40 kbps | — | 13.7 | 22 | mA |
| | I_{RXL} | Low Power Mode, 868 MHz, 40 kbps | — | 11.1 | — | mA |
| TX Mode Current (R63, R68) | $I_{\text{TX}+20}$ | +20 dBm output power, class-E match, 915 MHz, 3.3 V | — | 88 | 108 | mA |
| | | +20 dBm output power, square-wave match, 169 MHz, 3.3 V | — | 69 | 80 | mA |
| | | +13 dBm output power, class-E match, 915 MHz, 3.3 V | — | 44.5 | 60 | mA |
| TX Mode Current (R60, R67) | $I_{\text{TX}+10}$ | +10 dBm output power, class-E match, 868/915 MHz, 3.3 V | — | 19.7 | — | mA |
| | I_{TX_+10} | +10 dBm output power, class-E match, 169 MHz, 3.3 V | — | 18 | — | mA |
| | I_{TX_+13} | +13 dBm output power, class-E match, 868/915 MHz, 3.3 V | — | 22 | — | mA |
| TX Mode Current (R61) | I_{TX_+16} | +16 dBm output power, class-E match, 868 MHz, 3.3 V | — | 43 | 55 | mA |
| | I_{TX_+13} | +13 dBm output power, switched-current match, 868 MHz, 3.3 V | — | 33.5 | 40 | mA |

4.17.2 EZRadioPRO (R6x) Synthesizer AC Electrical Characteristics

Table 4.25. EZRadioPro Synthesizer

| Parameter | Symbol | Test Condition | Min | Typ | Max | Unit |
|----------------------------------|-----------------------|---|-----|------|------|---------------|
| Synthesizer Frequency Range | F_{SYN} | | 850 | — | 1050 | MHz |
| | | | 350 | — | 525 | MHz |
| | | | 284 | — | 350 | MHz |
| | | | 142 | — | 175 | MHz |
| Synthesizer Frequency Resolution | $F_{\text{RES-1050}}$ | 850–1050 MHz | — | 28.6 | — | Hz |
| | $F_{\text{RES-525}}$ | 420–525 MHz | — | 14.3 | — | Hz |
| | $F_{\text{RES-420}}$ | 350–420 MHz | — | 11.4 | — | Hz |
| | $F_{\text{RES-350}}$ | 283–350 MHz | — | 9.5 | — | Hz |
| | $F_{\text{RES-175}}$ | 142–175 MHz | — | 4.7 | — | Hz |
| Synthesizer Settling Time | t_{LOCK} | Measured from exiting Ready mode with XOSC running to any frequency. Including VCO Calibration. | — | 50 | — | μs |
| Phase Noise | $L_{\text{(fM)}}$ | F = 10 kHz, 169 MHz, High Perf Mode | — | –117 | –108 | dBc/Hz |
| | | F = 100 kHz, 169 MHz, High Perf Mode | — | –120 | –115 | dBc/Hz |
| | | F = 1 MHz, 169 MHz, High Perf Mode | — | –138 | –135 | dBc/Hz |
| | | F = 10 MHz, 169 MHz, High Perf Mode | — | –148 | –143 | dBc/Hz |
| | | F = 10 kHz, 915 MHz, High Perf Mode | — | –102 | –94 | dBc/Hz |
| | | F = 100 kHz, 915 MHz, High Perf Mode | — | –105 | –97 | dBc/Hz |
| | | F = 1 MHz, 915 MHz, High Perf Mode | — | –125 | –122 | dBc/Hz |
| | | F = 10 MHz, 915 MHz, High Perf Mode | — | –138 | –135 | dBc/Hz |

4.17.3 EZRadioPRO (R6x) Receiver AC Electrical Characteristics

For PER tests, 48 preamble symbols, 4 byte sync word, 10 byte payload and CRC-32 was used.

Measured over 50000 bits using PN9 data sequence and data and clock on GPIOs. Sensitivity is expected to be better if reading data from packet handler FIFO especially at higher data rates.

Table 4.26. EZRadioPro Receiver AC Electrical Characteristics

| Parameter | Symbol | Test Condition | Min | Typ | Max | Unit |
|---|---------------------|--|-----|--------|------|------|
| RX Frequency Range | F _{RX} | | 850 | — | 1050 | MHz |
| | | | 350 | — | 525 | MHz |
| | | | 284 | | 350 | MHz |
| | | | 142 | — | 175 | MHz |
| RX Sensitivity 169 MHz (R68, R67)3 | P _{RX_0.1} | (BER < 0.1%) (100 bps, GFSK, BT = 0.5, f = ±100 Hz) | — | -133 | — | dBm |
| RX Sensitivity 169 MHz (R60, R61, R63)3 | P _{RX_0.5} | (BER < 0.1%) (500 bps, GFSK, BT = 0.5, f = ±250 Hz) | — | -129 | — | dBm |
| RX Sensitivity 169 MHz (R60, R61, R63, R67, R68)3 | P _{RX_40} | (BER < 0.1%) (40 kbps, GFSK, BT = 0.5, f = ±20 kHz) | — | -110.7 | -108 | dBm |
| | P _{RX_100} | (BER < 0.1%) (100 kbps, GFSK, BT = 0.5, f = ±50 kHz) | — | -106 | -104 | dBm |
| | P _{RX_125} | (BER < 0.1%) (500 kbps, GFSK, BT = 0.5, f = ±250 kHz) | — | -99 | -96 | dBm |
| | P _{RX_9.6} | (PER 1%) (9.6 kbps, 4GFSK, BT = 0.5, f = ±2.4 kHz) | — | -110 | — | dBm |
| | P _{RX_1M} | (PER 1%) (1 Mbps, 4GFSK, BT = 0.5, inner deviation = 83.3 kHz) | — | -89 | — | dBm |
| | P _{RX_OOK} | (BER < 0.1%, 4.8 kbps, 350 kHz BW, OOK, PN15 data) | — | -110 | -107 | dBm |
| | | (BER < 0.1%, 40 kbps, 350 kHz BW, OOK, PN15 data) | — | -103 | -100 | dBm |
| | | (BER < 0.1%, 120 kbps, 350 kHz BW, OOK, PN15 data) | — | -97 | -93 | dBm |
| RX Sensitivity 915/868 MHz (R68, R67)3 | P _{RX_0.1} | (BER < 0.1%) (100 bps, GFSK, BT = 0.5, f = ±100 Hz) | — | -132 | — | dBm |
| RX Sensitivity 915/868 MHz (R60, R61, R63)3 | P _{RX_0.5} | (BER < 0.1%) (500 bps, GFSK, BT = 0.5, f = ±250 Hz) | — | -127 | — | dBm |
| RX Sensitivity 868 MHz (R60, R61, R63, R67, R68)3 | P _{RX_40} | (BER < 0.1%) (40 kbps, GFSK, BT = 0.5, f = ±20 kHz) | — | -109.9 | — | dBm |
| RX Sensitivity 915 MHz (R60, R61, R63, R67, R68)3 | | (BER < 0.1%) (40 kbps, GFSK, BT = 0.5, f = ±20 kHz) | — | -109.4 | — | dBm |

| Parameter | Symbol | Test Condition | Min | Typ | Max | Unit |
|--|---------------------|--|-----|--------|------|------|
| RX Sensitivity 915/868 MHz (R60, R61, R63, R67, R68)3 | P _{RX_100} | (BER < 0.1%) (100 kbps, GFSK, BT = 0.5, f = ±50 kHz) | — | -104 | -102 | dBm |
| | P _{RX_125} | (BER < 0.1%) (500 kbps, GFSK, BT = 0.5, f = ±250 kHz) | — | -97 | -92 | dBm |
| | P _{RX_9.6} | (PER 1%) (9.6 kbps, 4GFSK, BT = 0.5, f = ±2.4 kHz) | — | -110.6 | — | dBm |
| | P _{RX_1M} | (PER 1%) (1 Mbps, 4GFSK, BT = 0.5, inner deviation = 83.3 kHz) | — | -88.7 | — | dBm |
| | P _{RX_OOK} | (BER < 0.1%, 4.8 kbps, 350 kHz BW, OOK, PN15 data) | — | -108 | -104 | dBm |
| | | (BER < 0.1%, 40 kbps, 350 kHz BW, OOK, PN15 data) | — | -101 | -97 | dBm |
| (BER < 0.1%, 120 kbps, 350 kHz BW, OOK, PN15 data) | | — | -96 | -91 | dBm | |
| RX Channel Bandwidth (R60, R61, R63) | BW | | 1.1 | — | 850 | kHz |
| RX Channel Bandwidth (R68, R67) | | | 0.2 | — | 850 | kHz |
| RSSI Resolution | RES _{RSSI} | Valid from -110 dBm to -90 dBm | — | ±0.5 | — | dB |
| ±1-Ch Offset Selectivity, 169 MHz | C/I _{1-CH} | Desired Ref Signal 3 dB above sensitivity, BER, <0.1%. Interferer is CW and desired is modulated with 2.4 kbps F = 1.2 kHz GFSK with BT = 0.5, RX channel BW = 4.8 kHz, channel spacing = 12.5 kHz | — | -69 | -59 | dB |
| ±1-Ch Offset Selectivity, 450 MHz | | | — | -60 | -50 | dB |
| ±1-Ch Offset Selectivity, 868 / 915 MHz | | | — | -52.5 | -45 | dB |
| Blocking 1 MHz Offset | 1M _{BLOCK} | Desired Ref Signal 3 dB above sensitivity, BER, <0.1%. Interferer is CW and desired is modulated with 2.4 kbps F = 1.2 kHz GFSK with BT = 0.5, RX channel BW = 4.8 kHz | — | -79 | -68 | dB |
| Blocking 8 MHz Offset | 8M _{BLOCK} | | — | -86 | -75 | dB |

| Parameter | Symbol | Test Condition | Min | Typ | Max | Unit |
|-----------------------------------|-------------------|--|-----|-----|-----|------|
| Image Rejection (IF = 468.75 kHz) | Im _{REJ} | No image rejection calibration. Rejection at the image frequency. RF = 460 MHz | 30 | 40 | — | dB |
| | | With image rejection calibration. Rejection at the image frequency. RF = 460 MHz | 40 | 55 | — | dB |
| | | No image rejection calibration. Rejection at the image frequency. RF = 915 MHz | 30 | 45 | — | dB |
| | | With image rejection calibration. Rejection at the image frequency. RF = 915 MHz | 40 | 52 | — | dB |
| | | No image rejection calibration. Rejection at the image frequency. RF = 169 MHz | 35 | 45 | — | dB |
| | | With image rejection calibration. Rejection at the image frequency. RF = 169 MHz | 45 | 60 | — | dB |

4.17.4 EZRadioPRO (R6x) Transmitter AC Electrical Characteristics

The maximum data rate is dependent on the XTAL frequency and is calculated as per the formula: Maximum Symbol Rate = $F_{xtal}/60$, where F_{xtal} is the XTAL frequency (typically 30 MHz).

Default API setting for modulation deviation resolution is double the typical value specified.

Output power is dependent on matching components and board layout.

Table 4.27. EZRadioPro Transmitter AC Electrical Characteristics

| Parameter | Symbol | Test Condition | Min | Typ | Max | Unit |
|-------------------------------------|----------------|--|-----|------|-------|------|
| TX Frequency Range | F_{TX} | | 850 | — | 1050 | MHz |
| | | | 350 | — | 525 | MHz |
| | | | 284 | — | 350 | MHz |
| | | | 142 | — | 175 | MHz |
| (G)FSK Data Rate | DR_{FSK} | | 0.1 | — | 500 | kbps |
| 4(G)FSK Data Rate | DR_{4FSK} | | 0.2 | — | 1000 | kbps |
| OOK Data Rate | DR_{OOK} | | 0.1 | — | 120 | kbps |
| Modulation Deviation Range | f_{960} | 850–1050 MHz | — | 1.5 | — | MHz |
| | f_{525} | 420–525 MHz | — | 750 | — | kHz |
| | f_{420} | 350–420 MHz | — | 600 | — | kHz |
| | f_{350} | 283–350 MHz | — | 500 | — | kHz |
| | f_{175} | 142–175 MHz | — | 250 | — | kHz |
| Modulation Deviation Resolution | $F_{RES-1050}$ | 850–1050 MHz | — | 28.6 | — | Hz |
| | $F_{RES-525}$ | 420–525 MHz | — | 14.3 | — | Hz |
| | $F_{RES-420}$ | 350–420 MHz | — | 11.4 | — | Hz |
| | $F_{RES-350}$ | 283–350 MHz | — | 9.5 | — | Hz |
| | $F_{RES-175}$ | 142–175 MHz | — | 4.7 | — | Hz |
| Output Power Range (R63) | P_{TX63} | Typical Output Power Range at 3.3 V with Class E mtch optimized for best PA efficiency | –20 | — | +20 | dBm |
| Typical Output Power Range (R61) | P_{TX61} | Typical Output Power Range at 3.3 V with Class E mtch optimized for best PA efficiency | –40 | — | +16 | dBm |
| Typical Output Power Range at (R60) | P_{TX60} | Typical Output Power Range at 3.3 V with Class E mtch optimized for best PA efficiency | –20 | — | +12.5 | dBm |
| Typical Output Power Range at (R68) | P_{TX68} | Typical Output Power Range at 3.3 V with Class E mtch optimized for best PA efficiency | –20 | — | +20 | dBm |

| Parameter | Symbol | Test Condition | Min | Typ | Max | Unit |
|--|--------------------------|--|------|------|-------|------|
| Typical Output Power Range at (R67) | P _{TX67} | Typical Output Power Range at 3.3 V with Class E mtch optimized for best PA efficiency | -20 | — | +12.5 | dBm |
| Output Power Variation (R63, R68) | | At 20 dBm PA power setting, 915 MHz, Class E match, 3.3 V, 25 °C | 19 | 20 | 21 | dBm |
| Output Power Variation (R60, R67) | | At 10 dBm PA power setting, 915 MHz, Class E match, 3.3 V, 25 °C | 9 | 10 | 11 | dBm |
| Output Power Variation (R63, R68) | | At 20 dBm PA power setting, 169 MHz, Square Wave match, 3.3 V, 25 °C | 18.5 | 20 | 21 | dBm |
| Output Power Variation (R60, R67) | | At 10 dBm PA power setting, 169 MHz, Square Wave match, 3.3 V, 25 °C | 9.5 | 10 | 10.5 | dBm |
| TX RF Output Steps | P _{RF_OUT} | Using switched current match within 6 dB of max power | — | 0.25 | 0.4 | dB |
| TX RF Output Level Variation vs. Temperature | P _{RF_TEMP} | -40 to +85 °C | — | 2.3 | 3 | dB |
| TX RF Output Level Variation vs. Frequency | P- RF _{FREQ} | Measured across 902–928 MHz | — | 0.6 | 1.7 | dB |
| Transmit Modulation Filtering | B×T | Gaussian Filtering Bandwidth Time Product | — | 0.5 | — | |

4.17.5 EZRadioPRO (R6x) Radio Auxillary Block Specifications

Microcontroller clock frequency tested in production at 1 MHz, 30 MHz, 32 MHz, and 32.768 kHz. Other frequencies tested by bench characterization.

XTAL Range tested in production using an external clock source (similar to using a TCXO).

Table 4.28. EZRadioPro Auxiliary Block Specifications

| Parameter | Symbol | Test Condition | Min | Typ | Max | Unit |
|--|-----------------------|---|-----|------|-----|------|
| XTAL Range | XTAL _{RANGE} | | 25 | — | 32 | MHz |
| 30 MHz XTAL Start-Up Time | t _{30M} | Using XTAL and board layout in reference design. Start-up time will vary with XTAL type and board layout. | — | 300 | — | µs |
| 30 MHz XTAL Cap Resolution | 30M _{RES} | | — | 70 | — | fF |
| 32 kHz XTAL Start-Up Time | t _{32K} | | — | 2 | — | sec |
| 32 kHz Accuracy using Internal RC Oscillator | 32KRC _{RES} | | — | 2500 | — | ppm |
| POR Reset Time | t _{POR} | | — | — | 6 | ms |

4.17.6 EZRadio (R55) DC Electrical Characteristics

Table 4.29. EZRadio DC Characteristics

| Parameter | Symbol | Test Condition | Min | Typ | Max | Unit |
|--------------------|------------------------|---|-----|------|-----|------|
| Power Saving Modes | I_{shutdown} | RC Oscillator, Main Digital Regulator, and Low Power Digital Regulator OFF | — | 30 | — | nA |
| | I_{standby} | Register values maintained | — | 40 | — | nA |
| | I_{Ready} | Crystal Oscillator and Main Digital Regulator ON, all other blocks OFF | — | 1.8 | — | mA |
| | $I_{\text{SPIActive}}$ | SPI active state | — | 1.5 | — | mA |
| TUNE Mode Current | I_{TuneRX} | RX Tune | — | 6.8 | — | mA |
| | I_{TuneTX} | TX Tune | — | 7.1 | — | mA |
| RX Mode Current | I_{RX} | Measured at 40 kbps, 20 kHz deviation, 315 MHz | — | 10.9 | — | mA |
| TX Mode Current | I_{TX} | +10 dBm output power, measured on direct tie RF evaluation board at 868 MHz | — | 19 | — | mA |
| | | +13 dBm output power, measured on direct tie RF evaluation board at 868 MHz | — | 24 | — | mA |

4.17.7 EZRadio (R55) Synthesizer AC Electrical Characteristics

Table 4.30. EZRadio Synthesizer

| Parameter | Symbol | Test Condition | Min | Typ | Max | Unit |
|----------------------------------|----------------------|----------------------|-----|-------|-----|--------|
| Synthesizer Frequency Range | F_{SYN} | | 284 | — | 350 | MHz |
| | | | 350 | — | 525 | MHz |
| | | | 850 | — | 960 | MHz |
| Synthesizer Frequency Resolution | $F_{\text{RES-960}}$ | 850-960 MHz | — | 114.4 | — | Hz |
| | $F_{\text{RES-525}}$ | 420-525 MHz | — | 57.2 | — | Hz |
| | $F_{\text{RES-350}}$ | 283-350 MHz | — | 38.1 | — | Hz |
| Phase Noise | $L_{\text{(fM)}}$ | F = 10 kHz, 915 MHz | — | 100 | — | dBc/Hz |
| | | F = 100 kHz, 915 MHz | — | 102.1 | — | dBc/Hz |
| | | F = 1 MHz, 915 MHz | — | 123.5 | — | dBc/Hz |
| | | F = 10 MHz, 915 MHz | — | 136.6 | — | dBc/Hz |

4.17.8 EZRadio (R55) Receiver AC Electrical Characteristics

Table 4.31. EZRadio Receiver AC Electrical Characteristics

| Parameter | Symbol | Test Condition | Min | Typ | Max | Unit |
|--------------------------------|-----------------------|--|-----|-----------|-----|------|
| RX Frequency Range | F_{RX} | | 284 | — | 350 | MHz |
| | | | 350 | — | 525 | MHz |
| | | | 850 | — | 960 | MHz |
| RX Sensitivity 915 MHz | P_{RX_2} | (BER < 0.1%) (2.4 kbps, GFSK, BT = 0.5, $f = \pm 30$ kHz, 114 kHz RX BW) | — | -115 | — | dBm |
| | P_{RX_40} | (BER < 0.1%) (40 kbps, GFSK, BT = 0.5, $f = \pm 25$ kHz, 114 kHz RX BW) | — | -107.6 | — | dBm |
| | P_{RX_128} | (BER < 0.1%) (128 kbps, GFSK, BT = 0.5, $f = \pm 70$ kHz, 305 kHz RX BW) | — | -102.4 | — | dBm |
| | P_{RX_OOK} | (BER < 0.1%, 1 kbps, 185 kHz Rx BW, OOK, PN15 data) | — | -113.5 | — | dBm |
| | | (BER < 0.1%, 40 kbps, 185 kHz BW, OOK, PN15 data) | — | -102.7 | — | dBm |
| RX Channel Bandwidth | BW | | 40 | — | 850 | kHz |
| RSSI Resolution | RES _{RSSI} | Valid from -110 dBm to -90 dBm | — | ± 0.5 | — | dB |
| ± 1 -Ch Offset Selectivity | C/I_{1-CH} | Desired Ref Signal 3 dB above sensitivity, BER, <0.1%. Interferer is CW and desired is modulated with 1.2 kbps $F = 5.2$ kHz GFSK with BT = 0.5, RX channel BW = 58 kHz, channel spacing = 100 kHz | — | -50 | — | dB |
| ± 2 -Ch Offset Selectivity | C/I_{2-CH} | | — | -56 | — | dB |
| Blocking 200 kHz–1 MHz | 200K _{BLOCK} | Desired Ref Signal 3 dB above sensitivity, BER, <0.1%. Interferer is CW and desired is modulated with 1.2 kbps $F = 5.2$ kHz GFSK with BT = 0.5, RX channel BW = 58 kHz | — | -56 | — | dB |
| Blocking 1 MHz Offset | 1M _{BLOCK} | | — | -71 | — | dB |
| Blocking 8 MHz Offset | 8M _{BLOCK} | | — | -71 | — | dB |
| Image Rejection | Im _{REJ} | Rejection at the image frequency IF = 468 kHz | — | 40 | — | dB |

4.17.9 EZRadio (R55) Transmitter AC Electrical Characteristics

The maximum data rate is dependent on the XTAL frequency and is calculated as per the formula: Maximum Symbol Rate = $F_{xtal}/60$, where F_{xtal} is the XTAL frequency (typically 30 MHz).

Conducted measurements based on RF evaluation board. Output power and emissions specifications are dependent on transmit frequency, matching components, and board layout.

Table 4.32. EZRadio Transmitter AC Electrical Characteristics

| Parameter | Symbol | Test Condition | Min | Typ | Max | Unit |
|--|----------------|---|-----|-------|-----|------|
| TX Frequency Range | F_{TX} | | 284 | — | 350 | MHz |
| | | | 350 | — | 525 | MHz |
| | | | 850 | — | 960 | MHz |
| (G)FSK Data Rate | DR_{FSK} | | 1.0 | — | 500 | kbps |
| OOK Data Rate | DR_{OOK} | | 0.5 | — | 120 | kbps |
| Modulation Deviation Range | f_{960} | 850-960 MHz | — | — | 500 | kHz |
| | f_{525} | 350-525 MHz | — | — | 500 | kHz |
| | f_{350} | 284-350 MHz | — | — | 500 | kHz |
| Modulation Deviation Resolution | $F_{RES-960}$ | 850-960 MHz | — | 114.4 | — | Hz |
| | $F_{RES-525}$ | 420-525 MHz | — | 57.2 | — | Hz |
| | $F_{RES-420}$ | 350-420 MHz | — | 45.6 | — | Hz |
| | $F_{RES-350}$ | 284-350 MHz | — | 38.1 | — | Hz |
| Output Power Range | P_{TX} | Measured at 434 MHz, 3.3 V, Class E match | -20 | — | +13 | dBm |
| TX RF Output Steps | P_{RF_OUT} | Using switched current match within 6 dB of max power | — | 0.25 | — | dB |
| TX RF Output Level Variation vs. Temperature | P_{RF_TEMP} | -40 to +85 °C | — | 2.3 | — | dB |
| TX RF Output Level Variation vs. Frequency | P_{RF_FREQ} | Measured across 902-928 MHz | — | 0.6 | — | dB |
| Transmit Modulation Filtering | $B \times T$ | Gaussian Filtering Bandwidth Time Product | — | 0.5 | — | |

4.17.10 EZRadio (R55) Radio Auxiliary Block Specifications

XTAL Range tested in production using an external clock source (similar to using a TCXO).

Microcontroller clock frequency tested in production at 1 MHz, 30 MHz, 32 MHz, and 32.768 kHz. Other frequencies tested by bench characterization.

Table 4.33. EZRadio Auxilliary Block Specifications

| Parameter | Symbol | Test Condition | Min | Typ | Max | Unit |
|----------------------------|----------------|---|-----|-----|-----|------|
| XTAL Range | $XTAL_{RANGE}$ | | 25 | | 32 | MHz |
| 30 MHz XTAL Start-Up Time | t_{30M} | Using XTAL and board layout in reference design. Start-up time will vary with XTAL type and board layout. | — | 300 | — | us |
| 30 MHz XTAL Cap Resolution | $30M_{RES}$ | | — | 70 | — | Ff |
| POR Reset Time | t_{POR} | | — | — | 6 | ms |

4.17.11 EZRadioPRO/EZRadioPRO Digital I/O Specification

6.7 ns is typical for GPIO0 rise time.

Assuming $V_{DD} = 3.3$ V, drive strength is specified at $V_{OH}(\min) = 2.64$ V and $V_{OL}(\max) = 0.66$ V at room temperature.

2.4 ns is typical for GPIO0 fall time.

Table 4.34. EZRadio/Pro Digital I/O Specification

| Parameter | Symbol | Test Condition | Min | Typ | Max | Unit |
|---|--------------|---|-------------------------|------|-------------------------|------|
| Rise Time | T_{RISE} | $0.1 \times V_{DD}$ to $0.9 \times V_{DD}$, $C_L = 10$ pF, $DRV<1:0> = LL$ | — | 2.3 | — | ns |
| Fall Time | T_{FALL} | $0.9 \times V_{DD}$ to $0.1 \times V_{DD}$, $C_L = 10$ pF, $DRV<1:0> = LL$ | — | 2 | — | ns |
| Input Capacitance | C_{IN} | | — | 2 | — | pF |
| Logic High Level Input Voltage | V_{IH} | | $V_{DD_RF} \times 0.7$ | — | — | V |
| Logic Low Level Input Voltage | V_{IL} | | — | — | $V_{DD_RF} \times 0.3$ | V |
| Input Current | I_{IN} | $0 < V_{IN} < V_{DD}$ | -1 | — | 1 | uA |
| Input Current If Pullup is Activated | I_{INP} | $V_{IL} = 0$ V | 1 | — | 4 | uA |
| Drive Strength for Output Low Level ³ | I_{OmaxLL} | $DRV[1:0] = LL$ | — | 6.66 | — | mA |
| | I_{OmaxLH} | $DRV[1:0] = LH$ | — | 5.03 | — | mA |
| | I_{OmaxHL} | $DRV[1:0] = HL$ | — | 3.16 | — | mA |
| | I_{OmaxHH} | $DRV[1:0] = HH$ | — | 1.13 | — | mA |
| Drive Strength for Output High Level ³ | I_{OmaxLL} | $DRV[1:0] = LL$ | — | 5.75 | — | mA |
| | I_{OmaxLH} | $DRV[1:0] = LH$ | — | 4.37 | — | mA |
| | I_{OmaxHL} | $DRV[1:0] = HL$ | — | 2.73 | — | mA |
| | I_{OmaxHH} | $DRV[1:0] = HH$ | — | 0.96 | — | mA |
| Drive Strength for Output High Level for GPIO3 | I_{OmaxLL} | $DRV[1:0] = LL$ | — | 2.53 | — | mA |
| | I_{OmaxLH} | $DRV[1:0] = LH$ | — | 2.21 | — | mA |
| | I_{OmaxHL} | $DRV[1:0] = HL$ | — | 1.7 | — | mA |
| | I_{OmaxHH} | $DRV[1:0] = HH$ | — | 0.80 | — | mA |
| Logic High Level Output Voltage | V_{OH} | $DRV[1:0] = HL$ | $V_{DD_RF} \times 0.8$ | — | — | V |
| Logic Low Level Output Voltage | V_{OL} | $DRV[1:0] = HL$ | — | — | $V_{DD_RF} \times 0.2$ | V |

4.18 Digital Peripherals

Table 4.35. Digital Peripherals

| Parameter | Symbol | Condition | Min | Typ | Max | Unit |
|-----------------|----------------------|-------------------------------------|-----|------|-----|--------------------------|
| USART current | I_{USART} | USART idle current, clock enabled | — | 4.0 | — | $\mu\text{A}/\text{MHz}$ |
| UART current | I_{UART} | UART idle current, clock enabled | — | 3.8 | — | $\mu\text{A}/\text{MHz}$ |
| LEUART current | I_{LEUART} | LEUART idle current, clock enabled | — | 194 | — | nA |
| I2C current | I_{I2C} | I2C idle current, clock enabled | — | 7.6 | — | $\mu\text{A}/\text{MHz}$ |
| TIMER current | I_{TIMER} | TIMER_0 idle current, clock enabled | — | 6.5 | — | $\mu\text{A}/\text{MHz}$ |
| LETIMER current | I_{LETIMER} | LETIMER idle current, clock enabled | — | 86 | — | nA |
| PCNT current | I_{PCNT} | PCNT idle current, clock enabled | — | 91 | — | nA |
| RTC current | I_{RTC} | RTC idle current, clock enabled | — | 55 | — | nA |
| AES current | I_{AES} | AES idle current, clock enabled | — | 1.8 | — | $\mu\text{A}/\text{MHz}$ |
| GPIO current | I_{GPIO} | GPIO idle current, clock enabled | — | 3.4 | — | $\mu\text{A}/\text{MHz}$ |
| PRS current | I_{PRS} | PRS idle current | — | 3.9 | — | $\mu\text{A}/\text{MHz}$ |
| DMA current | I_{DMA} | Clock enable | — | 10.9 | — | $\mu\text{A}/\text{MHz}$ |

5. Pinout and Package

Note: Please refer to the application note *AN0002: EFM32 Hardware Design Considerations* for guidelines on designing Printed Circuit Boards (PCB's) for the EZR32LG330.

5.1 Pinout

The EZR32LG330 pinout is shown in below. Alternate locations are denoted by "#" followed by the location number (Multiple locations on the same pin are split with "/"). Alternate locations can be configured in the LOCATION bitfield in the *_ROUTE register in the module in question.

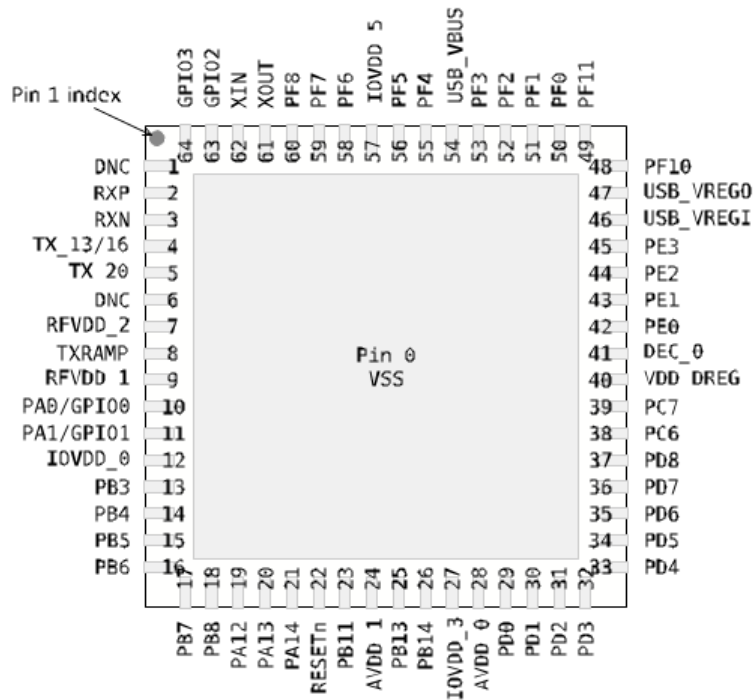

Figure 5.1. Pinout (top view, not to scale)

5.2 Pin Descriptions

Table 5.1. Device Pinout

| QFN64 Pin# and Name | | Pin Alternate Functionality / Description | | | |
|---------------------|------------------------|--|-----------------------------|------------------------|---------------------------------------|
| Pin # | Pin Name | Analog | Timers | Communication | Other |
| 0 | VSS | Ground. | | | |
| 1 | NC | No connect. | | | |
| 2 | RXP | Differential RF Input Pin of the LNA. See application schematic for example matching network. | | | |
| 3 | RXN | Differential RF Input Pin of the LNA. See application schematic for example matching network. | | | |
| 4 | TX_13/16 | Transmit Output Pin (+13 dBm or +16 dBm) for R55, R60, R61, R67 and R69 variants. The PA output is an open-drain connection, so the L-C match must supply VDD (+3.3 VDC nominal) to this pin. Pin is DNC on the +20 dBm parts. | | | |
| 5 | TX_20 | Transmit Output Pin (+20 dBm) for R63, R68 and R69 variants. The PA output is an open-drain connection, so the L-C match must supply VDD (+3.3 VDC nominal) to this pin. Pin is DNC on the +13 dBm parts. | | | |
| 6 | NC | No connect. | | | |
| 7 | RFVDD_2 | +1.8 to +3.6 V Supply Voltage Input to Internal Regulators for the Radio. The recommended VDD supply voltage is +3.3 V. | | | |
| 8 | TXRAMP | Programmable Bias Output with Ramp Capability for External FET PA. | | | |
| 9 | RFVDD_1 | +1.8 to +3.6 V Supply Voltage Input to Internal Regulators for the Radio. The recommended VDD supply voltage is +3.3 V. | | | |
| 10 | PA0/GPIO0 ¹ | | TIM0_CC0 #0/1/4 | LEU0_RX #4 I2C0_SDA #0 | PRS_CH0 #0 GPIO_EM4WU0 RF_GPIO0 |
| 11 | PA1/GPIO1 ¹ | | TIM0_CC1 #0/1 | I2C0_SCL #0 | CMU_CLK1 #0 PRS_CH1 #0 RF_GPIO1 |
| 12 | IOVDD_0 | Digital IO power supply 0. | | | |
| 13 | PB3 | | PCNT1_S0IN #1 | US2_TX #1 | |
| 14 | PB4 | | PCNT1_S1IN #1 | US2_RX #1 | |
| 15 | PB5 | | | US2_CLK #1 | |
| 16 | PB6 | | | US2_CS #1 | |
| 17 | PB7 | LFXTAL_P | TIM1_CC0 #3 | USRF0_TX #4 | |
| 18 | PB8 | LFXTAL_N | TIM1_CC1 #3 | USRF0_RX #4 | |
| 19 | PA12 | | TIM2_CC0 #1 | | |
| 20 | PA13 | | TIM2_CC1 #1 | | |
| 21 | PA14 | | TIM2_CC2 #1 | | |
| 22 | RESETn | Reset input, active low. To apply an external reset source to this pin, it is required to only drive this pin low during reset, and let the internal pull-up ensure that reset is released. | | | |
| 23 | PB11 | | TIM1_CC2 #3 LE-TIM0_OUT0 #1 | | |
| 24 | AVDD_1 | Analog power supply 1. | | | |
| 25 | PB13 | HFXTAL_P | | LEU0_TX #1 | |

| QFN64 Pin# and Name | | Pin Alternate Functionality / Description | | | |
|---------------------|-----------|--|--|--------------------------------------|---|
| Pin # | Pin Name | Analog | Timers | Communication | Other |
| 26 | PB14 | HFXTAL_N | | LEU0_RX #1 | |
| 27 | IOVDD_3 | Digital IO power supply 3. | | | |
| 28 | AVDD_0 | Analog power supply 0. | | | |
| 29 | PD0 | ADC0_CH0 OPAMP_OUT2 #1 | PCNT2_S0IN #0 | US1_TX #1 | |
| 30 | PD1 | ADC0_CH1 DAC0_OUT1ALT #4/ OPAMP_OUT1ALT | TIM0_CC0 #3 PCNT2_S1IN #0 | US1_RX #1 | DBG_SWO #2 |
| 31 | PD2 | ADC0_CH2 | TIM0_CC1 #3 | USB_DMPU #0 US1_CLK #1 | DBG_SWO #3 |
| 32 | PD3 | ADC0_CH3 OPAMP_N2 | TIM0_CC2 #3 | US1_CS #1 | ETM_TD1 #0/2 |
| 33 | PD4 | ADC0_CH4 OPAMP_P2 | | LEU0_TX #0 | ETM_TD2 #0/2 |
| 34 | PD5 | ADC0_CH5 OPAMP_OUT2 #0 | | LEU0_RX #0 | ETM_TD3 #0/2 |
| 35 | PD6 | ADC0_CH6 DAC0_P1 / OPAMP_P1 | TIM1_CC0 #4 LE- TIM0_OUT0 #0 PCNT0_S0IN #3 | US1_RX #2 I2C0_SDA #1 | LES_ALTEX0 #0 ACMP0_O #2 ETM_TDO #0 BOOT_RX |
| 36 | PD7 | ADC0_CH7 DAC0_N1 / OPAMP_N1 | TIM1_CC1 #4 LE- TIM0_OUT1 #0 PCNT0_S1IN #3 | US1_TX #2 I2C0_SCL #1 | CMU_CLK0 #2 LES_AL- TEX1 #0 ACMP1_O #2 ETM_TCLK #0 BOOT_TX |
| 37 | PD8 | BU_VIN | | | CMU_CLK1 #1 |
| 38 | PC6 | ACMP0_CH6 | | LEU1_TX #0 I2C0_SDA #2 | LES_CH6 #0 ETM_TCLK #2 |
| 39 | PC7 | ACMP0_CH7 | | LEU1_RX #0 I2C0_SCL #2 | LES_CH7 #0 ETM_TDO #2 |
| 40 | VDD_DREG | Power supply for on-chip voltage regulator. | | | |
| 41 | DEC_0 | Decouple output for on-chip voltage regulator. | | | |
| 42 | PE0 | | TIM3_CC0 #1 PCNT0_S0IN #1 | U0_TX #1 I2C1_SDA #2 | |
| 43 | PE1 | | TIM3_CC1 #1 PCNT0_S1IN #1 | U0_RX #1 I2C1_SCL #2 | |
| 44 | PE2 | BU_VOUT | TIM3_CC2 #1 | U1_TX #3 | ACMP0_O #1 |
| 45 | PE3 | BU_STAT | | U1_RX #3 | ACMP1_O #1 |
| 46 | USB_VREGI | | | | |
| 47 | USB_VREGO | | | | |
| 48 | PF10 | | | | |
| 49 | PF11 | | | | |
| 50 | PF0 | | TIM0_CC0 #5 LE- TIM0_OUT0 #2 | US1_CLK #2 LEU0_TX #3 I2C0_SDA #5 | DBG_SWCLK #0/1/2/3 |
| 51 | PF1 | | TIM0_CC1 #5 LE- TIM0_OUT1 #2 | US1_CS #2 LEU0_RX #3 I2C0_SCL #5 | DBG_SWDIO #0/1/2/3 GPIO_EM4WU3 |

| QFN64 Pin# and Name | | Pin Alternate Functionality / Description | | | |
|---|----------|--|-----------------|---------------|---|
| Pin # | Pin Name | Analog | Timers | Communication | Other |
| 52 | PF2 | | TIM0_CC2 #5 | LEU0_TX #4 | ACMP1_O #0 DBG_SWO #0 GPIO_EM4WU4 |
| 53 | PF3 | | TIM0_CDTI0 #2/5 | | PRS_CH0 #1 |
| 54 | USB_VBUS | USB 5.0 V VBUS input. | | | |
| 55 | PF4 | | TIM0_CDTI1 #2/5 | | PRS_CH1 #1 |
| 56 | PF5 | | TIM0_CDTI2 #2/5 | USB_VBUSEN #0 | PRS_CH2 #1 |
| 57 | IOVDD_5 | Digital IO power supply 5. | | | |
| 58 | PF6 | | TIM0_CC0 #2 | | |
| 59 | PF7 | | TIM0_CC1 #2 | | |
| 60 | PF8 | | TIM0_CC2 #2 | | |
| 61 | XOUT | EZRadio peripheral crystal oscillator output. Connect to an external 26/30 MHz crystal or to an external clock source. If using an external clock source with no crystal, dc coupling with a nominal 0.8 VDC level is recommended with a minimum ac amplitude of 700 mVpp. Refer to AN417 for more details about using an external clock source. | | | |
| 62 | XIN | EZRadio peripheral crystal oscillator input. Connect to an external 26/30 MHz crystal or leave floating if driving the XOUT pin with an external signal source. | | | |
| 63 | GPIO2 | General Purpose Digital I/O for the radio. May be configured to perform various EZRadio functions, including Clock Output, FIFO Status, POR, Wake-up Timer, TRSW, AntDiversity control, etc. | | | |
| 64 | GPIO3 | General Purpose Digital I/O for the radio. May be configured to perform various EZRadio functions, including Clock Output, FIFO Status, POR, Wake-up Timer, TRSW, AntDiversity control, etc. | | | |
| Note: | | | | | |
| 1. General Purpose Digital I/O for the radio. May be configured to perform various EZRadio functions, including Clock Output, FIFO Status, POR, Wake-up Timer, TRSW, AntDiversity control, etc. | | | | | |

5.3 Alternate Functionality Pinout

A wide selection of alternate functionality is available for multiplexing to various pins. This is shown in the table. The table shows the name of the alternate functionality in the first column, followed by columns showing the possible LOCATION bitfield settings.

Note: Some functionality, such as analog interfaces, do not have alternate settings or a LOCATION bitfield. In these cases, the pinout is shown in the column corresponding to the LOCATION 0.

Table 5.2. Alternate functionality overview

| Alternate Functionality | LOCATION | | | | | | Description |
|-------------------------------------|-----------|-----|-----|---|-----|---|---|
| | 0 | 1 | 2 | 3 | 4 | 5 | |
| ACMP0_CH6 | PC6 | | | | | | Analog comparator ACMP0, channel 6. |
| ACMP0_CH7 | PC7 | | | | | | Analog comparator ACMP0, channel 7. |
| ACMP0_O | | PE2 | PD6 | | | | Analog comparator ACMP0, digital output. |
| ACMP1_O | PF2 | PE3 | PD7 | | | | Analog comparator ACMP1, digital output. |
| ADC0_CH0 | PD0 | | | | | | Analog to digital converter ADC0, input channel number 0. |
| ADC0_CH1 | PD1 | | | | | | Analog to digital converter ADC0, input channel number 1. |
| ADC0_CH2 | PD2 | | | | | | Analog to digital converter ADC0, input channel number 2. |
| ADC0_CH3 | PD3 | | | | | | Analog to digital converter ADC0, input channel number 3. |
| ADC0_CH4 | PD4 | | | | | | Analog to digital converter ADC0, input channel number 4. |
| ADC0_CH5 | PD5 | | | | | | Analog to digital converter ADC0, input channel number 5. |
| ADC0_CH6 | PD6 | | | | | | Analog to digital converter ADC0, input channel number 6. |
| ADC0_CH7 | PD7 | | | | | | Analog to digital converter ADC0, input channel number 7. |
| BOOT_RX | PD6 | | | | | | Bootloader RX. |
| BOOT_TX | PD7 | | | | | | Bootloader TX. |
| BU_STAT | PE3 | | | | | | Backup Power Domain status, whether or not the system is in backup mode |
| BU_VIN | PD8 | | | | | | Battery input for Backup Power Domain |
| BU_VOUT | PE2 | | | | | | Power output for Backup Power Domain |
| CMU_CLK0 | | | PD7 | | | | Clock Management Unit, clock output number 0. |
| CMU_CLK1 | PA1/GPIO1 | PD8 | | | | | Clock Management Unit, clock output number 1. |
| DAC0_N1 / OPAMP_N1 | PD7 | | | | | | Operational Amplifier 1 external negative input. |
| OPAMP_N2 | PD3 | | | | | | Operational Amplifier 2 external negative input. |
| DAC0_OUT1ALT / OPAMP_OUT1A LT | | | | | PD1 | | Digital to Analog Converter DAC0_OUT1ALT / OPAMP alternative output for channel 1. |
| OPAMP_OUT2 | PD5 | PD0 | | | | | Operational Amplifier 2 output. |

| Alternate | LOCATION | | | | | | Description |
|--------------------|-----------|------|-----|-----|---------------|-----|---|
| | 0 | 1 | 2 | 3 | 4 | 5 | |
| DAC0_P1 / OPAMP_P1 | PD6 | | | | | | Operational Amplifier 1 external positive input. |
| OPAMP_P2 | PD4 | | | | | | Operational Amplifier 2 external positive input. |
| DBG_SWCLK | PF0 | PF0 | PF0 | PF0 | | | Debug-interface Serial Wire clock input. Note that this function is enabled to pin out of reset, and has a built-in pull down. |
| DBG_SWDIO | PF1 | PF1 | PF1 | PF1 | | | Debug-interface Serial Wire data input / output. Note that this function is enabled to pin out of reset, and has a built-in pull up. |
| DBG_SWO | PF2 | | PD1 | PD2 | | | Debug-interface Serial Wire viewer Output. Note that this function is not enabled after reset, and must be enabled by software to be used. |
| ETM_TCLK | PD7 | | PC6 | | | | Embedded Trace Module ETM clock . |
| ETM_TD0 | PD6 | | PC7 | | | | Embedded Trace Module ETM data 0. |
| ETM_TD1 | PD3 | | PD3 | | | | Embedded Trace Module ETM data 1. |
| ETM_TD2 | PD4 | | PD4 | | | | Embedded Trace Module ETM data 2. |
| ETM_TD3 | PD5 | | PD5 | | | | Embedded Trace Module ETM data 3. |
| GPIO_EM4WU0 | PA0/GPIO0 | | | | | | Pin can be used to wake the system up from EM4 |
| GPIO_EM4WU3 | PF1 | | | | | | Pin can be used to wake the system up from EM4 |
| GPIO_EM4WU4 | PF2 | | | | | | Pin can be used to wake the system up from EM4 |
| HFX TAL_N | PB14 | | | | | | High Frequency Crystal negative pin. Also used as external optional clock input pin. |
| HFX TAL_P | PB13 | | | | | | High Frequency Crystal positive pin. |
| I2C0_SCL | PA1/GPIO1 | PD7 | PC7 | | | PF1 | I2C0 Serial Clock Line input / output. |
| I2C0_SDA | PA0/GPIO0 | PD6 | PC6 | | | PF0 | I2C0 Serial Data input / output. |
| I2C1_SCL | | | PE1 | | | | I2C1 Serial Clock Line input / output. |
| I2C1_SDA | | | PE0 | | | | I2C1 Serial Data input / output. |
| LES_ALTEX0 | PD6 | | | | | | LESENSE alternate exte output 0. |
| LES_ALTEX1 | PD7 | | | | | | LESENSE alternate exte output 1. |
| LES_CH6 | PC6 | | | | | | LESENSE channel 6. |
| LES_CH7 | PC7 | | | | | | LESENSE channel 7. |
| LETIM0_OUT0 | PD6 | PB11 | PF0 | | | | Low Energy Timer LETIM0, output channel 0. |
| LETIM0_OUT1 | PD7 | | PF1 | | | | Low Energy Timer LETIM0, output channel 1. |
| LEU0_RX | PD5 | PB14 | | PF1 | PA0/ GPIO0 | | LEUART0 Receive input. |
| LEU0_TX | PD4 | PB13 | | PF0 | PF2 | | LEUART0 Transmit output. Also used as receive input in half duplex communication. |
| LEU1_RX | PC7 | | | | | | LEUART1 Receive input. |
| LEU1_TX | PC6 | | | | | | LEUART1 Transmit output. Also used as receive input in half duplex communication. |

| Alternate | LOCATION | | | | | | Description |
|------------|-----------|-----------|-----|------|-----------|-----|---|
| | 0 | 1 | 2 | 3 | 4 | 5 | |
| LFXTAL_N | PB8 | | | | | | Low Frequency Crystal (typically 32.768 kHz) negative pin. Also used as an optional external clock input pin. |
| LFXTAL_P | PB7 | | | | | | Low Frequency Crystal (typically 32.768 kHz) positive pin. |
| PCNT0_S0IN | | PE0 | | PD6 | | | Pulse Counter PCNT0 input number 0. |
| PCNT0_S1IN | | PE1 | | PD7 | | | Pulse Counter PCNT0 input number 1. |
| PCNT1_S0IN | | PB3 | | | | | Pulse Counter PCNT1 input number 0. |
| PCNT1_S1IN | | PB4 | | | | | Pulse Counter PCNT1 input number 1. |
| PCNT2_S0IN | PD0 | | | | | | Pulse Counter PCNT2 input number 0. |
| PCNT2_S1IN | PD1 | | | | | | Pulse Counter PCNT2 input number 1. |
| PRS_CH0 | PA0/GPIO0 | PF3 | | | | | Peripheral Reflex System PRS, channel 0. |
| PRS_CH1 | PA1/GPIO1 | PF4 | | | | | Peripheral Reflex System PRS, channel 1. |
| PRS_CH2 | | PF5 | | | | | Peripheral Reflex System PRS, channel 2. |
| RF_GPIO0 | PA0/GPIO0 | | | | | | RF GPIO0. |
| RF_GPIO1 | PA1/GPIO1 | | | | | | RF GPIO1. |
| TIM0_CC0 | PA0/GPIO0 | PA0/GPIO0 | PF6 | PD1 | PA0/GPIO0 | PF0 | Timer 0 Capture Compare input / output channel 0. |
| TIM0_CC1 | PA1/GPIO1 | PA1/GPIO1 | PF7 | PD2 | | PF1 | Timer 0 Capture Compare input / output channel 1. |
| TIM0_CC2 | | | PF8 | PD3 | | PF2 | Timer 0 Capture Compare input / output channel 2. |
| TIM0_CDTI0 | | | PF3 | | | PF3 | Timer 0 Complimentary Deat Time Insertion channel 0. |
| TIM0_CDTI1 | | | PF4 | | | PF4 | Timer 0 Complimentary Deat Time Insertion channel 1. |
| TIM0_CDTI2 | | | PF5 | | | PF5 | Timer 0 Complimentary Deat Time Insertion channel 2. |
| TIM1_CC0 | | | | PB7 | PD6 | | Timer 1 Capture Compare input / output channel 0. |
| TIM1_CC1 | | | | PB8 | PD7 | | Timer 1 Capture Compare input / output channel 1. |
| TIM1_CC2 | | | | PB11 | | | Timer 1 Capture Compare input / output channel 2. |
| TIM2_CC0 | | PA12 | | | | | Timer 2 Capture Compare input / output channel 0. |
| TIM2_CC1 | | PA13 | | | | | Timer 2 Capture Compare input / output channel 1. |
| TIM2_CC2 | | PA14 | | | | | Timer 2 Capture Compare input / output channel 2. |
| TIM3_CC0 | | PE0 | | | | | Timer 3 Capture Compare input / output channel 0. |
| TIM3_CC1 | | PE1 | | | | | Timer 3 Capture Compare input / output channel 1. |
| TIM3_CC2 | | PE2 | | | | | Timer 3 Capture Compare input / output channel 2. |
| U0_RX | | PE1 | | | | | UART0 Receive input. |
| U0_TX | | PE0 | | | | | UART0 Transmit output. Also used as receive input in half duplex communication. |
| U1_RX | | | | PE3 | | | UART1 Receive input. |

| Alternate | LOCATION | | | | | | |
|---------------|-----------|-----|-----|-----|-----|---|---|
| Functionality | 0 | 1 | 2 | 3 | 4 | 5 | Description |
| U1_TX | | | | PE2 | | | UART1 Transmit output. Also used as receive input in half duplex communication. |
| US1_CLK | | PD2 | PF0 | | | | USART1 clock input / output. |
| US1_CS | | PD3 | PF1 | | | | USART1 chip select input / output. |
| US1_RX | | PD1 | PD6 | | | | USART1 Asynchronous Receive. USART1 Synchronous mode Master Input / Slave Output (MISO). |
| US1_TX | | PD0 | PD7 | | | | USART1 Asynchronous Transmit. Also used as receive input in half duplex communication. USART1 Synchronous mode Master Output / Slave Input (MOSI). |
| US2_CLK | | PB5 | | | | | USART2 clock input / output. |
| US2_CS | | PB6 | | | | | USART2 chip select input / output. |
| US2_RX | | PB4 | | | | | USART2 Asynchronous Receive. USART2 Synchronous mode Master Input / Slave Output (MISO). |
| US2_TX | | PB3 | | | | | USART2 Asynchronous Transmit. Also used as receive input in half duplex communication. USART2 Synchronous mode Master Output / Slave Input (MOSI). |
| USB_DM | PF10 | | | | | | USB D- pin. |
| USB_DMPU | PD2 | | | | | | USB D- Pullup control. |
| USB_DP | PF11 | | | | | | USB D+ pin. |
| USB_VBUS | USB_VBUS | | | | | | USB 5 V VBUS input. |
| USB_VBUSEN | PF5 | | | | | | USB 5 V VBUS enable. |
| USB_VREGI | USB_VREGI | | | | | | USB Input to internal 3.3 V regulator |
| USB_VREGO | USB_VREGO | | | | | | USB Decoupling for internal 3.3 V USB regulator and regulator output |
| USRF0_RX | | | | | PB8 | | USARTRF0 Asynchronous Receive. USARTRF0 Synchronous mode Master Input / Slave Output (MISO). |
| USRF0_TX | | | | | PB7 | | USARTRF0 Asynchronous Transmit. Also used as receive input in half duplex communication. USARTRF0 Synchronous mode Master Output / Slave Input (MOSI). |

5.4 GPIO Pinout Overview

The specific GPIO pins available in EZR32LG330 are shown in the GPIO pinout table. Each GPIO port is organized as 16-bit ports indicated by letters A through F, and the individual pin on this port is indicated by a number from 15 down to 0.

Table 5.3. GPIO Pinout

| Port | Pin 15 | Pin 14 | Pin 13 | Pin 12 | Pin 11 | Pin 10 | Pin 9 | Pin 8 | Pin 7 | Pin 6 | Pin 5 | Pin 4 | Pin 3 | Pin 2 | Pin 1 | Pin 0 |
|--------|--------|--------|--------|--------|--------|--------|-------|-------|-------|-------|-------|-------|-------|-------|-------|-------|
| Port A | - | PA14 | PA13 | PA12 | - | - | - | - | - | - | - | - | - | - | - | - |
| Port B | - | PB14 | PB13 | - | PB11 | - | - | PB8 | PB7 | PB6 | PB5 | PB4 | PB3 | - | - | - |
| Port C | - | - | - | - | - | - | - | - | PC7 | PC6 | - | - | - | - | - | - |
| Port D | - | - | - | - | - | - | - | PD8 | PD7 | PD6 | PD5 | PD4 | PD3 | PD2 | PD1 | PD0 |
| Port E | - | - | - | - | - | - | - | - | - | - | - | - | PE3 | PE2 | PE1 | PE0 |
| Port F | - | - | - | - | PF11 | PF10 | - | PF8 | PF7 | PF6 | PF5 | PF4 | PF3 | PF2 | PF1 | PF0 |

5.5 Opamp Pinout Overview

The specific opamp terminals available in EZR32LG330 are shown in Opamp pinout figure.

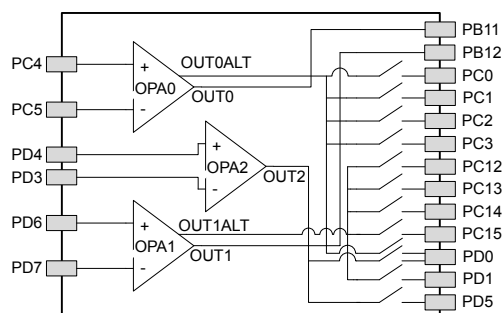

Figure 5.2. Opamp Pinout

5.6 QFN64 Package



Figure 5.3. QFN64

Note:

1. All dimensions shown are in millimeters (mm) unless otherwise noted.
2. Dimensioning and Tolerancing per ANSI Y14.5M-1994.
3. This drawing conforms to JEDEC outline MO-220 except for custom features D2, E2, L, Z, and Y which are toleranced per supplier designation.
4. Recommended card reflow profile is per the JEDEC/IPC J-STD-020 specification for Small Body Components.

Table 5.4. QFN64 (Dimensions in mm)

| Symbol | A | A1 | A3 | b | D/E | D2/E2 | e | L | R | K | aaa | bbb | ccc | ddd | eee | fff |
|--------|------|------|-------------|------|------|-------|-------------|------|------|------|------|------|------|------|------|------|
| Min | 0.80 | 0.00 | 0.20 REF | 0.18 | 8.9 | 7.25 | 0.50 BSC | 0.30 | 0.09 | 0.20 | 0.15 | 0.10 | 0.10 | 0.05 | 0.08 | 0.10 |
| Nom | 0.85 | 0.02 | | 0.25 | 9.00 | 7.40 | | 0.40 | — | — | | | | | | |
| Max | 0.90 | 0.05 | | 0.30 | 9.1 | 7.55 | | 0.50 | — | — | | | | | | |

The QFN64 Package uses Matte Tin plated leadframe. All EFR32 packages are RoHS compliant and free of Bromine (Br) and Antimony (Sb).

For additional Quality and Environmental information, please see: <http://www.silabs.com/support/quality/pages/default.aspx>

6. PCB Layout and Soldering

6.1 Recommended PCB Layout



Figure 6.1. PCB Land Pattern

Table 6.1. PCB Land Pattern Dimensions (Dimensions in mm)

| Symbol | Dimension (mm) |
|--------|----------------|
| S1 | 8.01 |
| S | 8.01 |
| L1 | 7.55 |
| W1 | 7.55 |
| e | 0.50 |
| W | 0.26 |
| L | 0.86 |

| Symbol | Dimension (mm) |
|--|----------------|
| Note: | |
| General | |
| <ol style="list-style-type: none">1. All dimensions shown are in millimeters (mm) unless otherwise noted.2. This Land Pattern Design is based on the IPC-7351 guidelines. | |
| Solder Mask Design | |
| <ol style="list-style-type: none">1. All metal pads are to be non-solder mask defined (NSMD). Clearance between the solder mask and the metal pad is to be 60 μm minimum, all the way around the pad. | |
| Stencil Design | |
| <ol style="list-style-type: none">1. A stainless steel, laser-cut and electro-polished stencil with trapezoidal walls should be used to assure good solder paste release.2. The stencil thickness should be 0.125 mm (5 mils).3. The ratio of stencil aperture to land pad size should be 1:1 for all perimeter pads.4. A 4x4 array of 1.45 mm square openings on a 1.25 mm pitch should be used for the center ground pad. | |
| Card Assembly | |
| <ol style="list-style-type: none">1. A No-Clean, Type-3 solder paste is recommended.2. The recommended card reflow profile is per the JEDEC/IPC J-STD-020 specification for Small Body Components. | |

6.2 Soldering Information

The latest IPC/JEDEC J-STD-020 recommendations for Pb-Free reflow soldering should be followed.

The packages have a Moisture Sensitivity Level rating of 3, please see the latest IPC/JEDEC J-STD-033 standard for MSL description and level 3 bake conditions. Place as many and as small as possible vias underneath each of the solder patches under the ground pad.

7. Top Marking

The top marking is illustrated and explained below.



| | | |
|------------------------|---|---|
| Mark Method: | Laser | |
| Logo Size: | Top center | |
| Font Size: | 0.71 mm Left-Justified | |
| Line 1 Marking: | FFFFFFFF = Family Part Number (EZR32) | Refer to the line marking instruction from assembly PO. |
| Line 2 Marking: | P P P P P P P P P P = Part Number <ul style="list-style-type: none"> • P₁P₂: LG = Leopard Gecko • P₃P₄P₅: 230 (non USB) • P₅P₆: Flash Size <ul style="list-style-type: none"> • FE = 64 • FF = 128 • FG = 256 | <ul style="list-style-type: none"> • P₇P₈: Radio <ul style="list-style-type: none"> • 55 = EZRadio +13 dBm, -116 sensitivity • 60 = EZRadioPRO +13 dBm, -129 sensitivity • 61 = EZRadioPRO +16 dBm, -129 sensitivity • 63 = EZRadioPRO +20 dBm, -129 sensitivity • 67 = EZRadioPRO +13 dBm, -133 sensitivity • 68 = EZRadioPRO +20 dBm, -133 sensitivity • 69 = EZRadioPRO +13 & 20 dBm, -133 sensitivity • P_g: Temperature Range <ul style="list-style-type: none"> • G = -40 - 85 °C |
| Line 3 Marking: | YY = Year | Assigned by the Assembly House. |
| | WW = Work Week | Corresponds to the year and work week of the mold date. |
| | TTTTTT = Mfg Code | Manufacturing Code from the Assembly Purchase Order from assembly PO. |
| Line 4 Marking: | Circle = 1.3 mm diameter; center justified | "e3" Pb-Free Symbol |
| | Gecko Logo; right justified | Gecko Logo height = 1.90 mm |

8. Revision History

8.1 Revision History

Revision 0.5

- Initial preliminary revision

| | |
|--|-----------|
| 1. Feature List | 1 |
| 2. Ordering Information | 2 |
| 3. System Overview | 3 |
| 3.1 Introduction | 3 |
| 3.1.1 ARM Cortex-M3 Core | 3 |
| 3.1.2 Debugging | 3 |
| 3.1.3 Memory System Controller (MSC) | 3 |
| 3.1.4 Direct Memory Access Controller (DMA) | 4 |
| 3.1.5 Reset Management Unit (RMU) | 4 |
| 3.1.6 Energy Management Unit (EMU) | 4 |
| 3.1.7 Clock Management Unit (CMU) | 4 |
| 3.1.8 Watchdog (WDOG) | 4 |
| 3.1.9 Peripheral Reflex System (PRS) | 4 |
| 3.1.10 Universal Serial Bus Controller (USB) | 4 |
| 3.1.11 Inter-Integrated Circuit Interface (I ² C) | 4 |
| 3.1.12 Universal Synchronous/Asynchronous Receiver/Transmitter (USART) | 4 |
| 3.1.13 Pre-Programmed UART Bootloader | 4 |
| 3.1.14 Universal Asynchronous Receiver/Transmitter (UART) | 5 |
| 3.1.15 Low Energy Universal Asynchronous Receiver/Transmitter (LEUART) | 5 |
| 3.1.16 Timer/Counter (TIMER) | 5 |
| 3.1.17 Real Time Counter (RTC) | 5 |
| 3.1.18 Backup Real Time Counter (BURTC) | 5 |
| 3.1.19 Low Energy Timer (LETIMER) | 5 |
| 3.1.20 Pulse Counter (PCNT) | 5 |
| 3.1.21 Analog Comparator (ACMP) | 5 |
| 3.1.22 Voltage Comparator (VCMP) | 5 |
| 3.1.23 Analog to Digital Converter (ADC) | 5 |
| 3.1.24 Digital to Analog Converter (DAC) | 5 |
| 3.1.25 Operational Amplifier (OPAMP) | 6 |
| 3.1.26 Low Energy Sensor Interface (LESENSE) | 6 |
| 3.1.27 Backup Power Domain | 6 |
| 3.1.28 Advanced Encryption Standard Accelerator (AES) | 6 |
| 3.1.29 General Purpose Input/Output (GPIO) | 6 |
| 3.1.30 EZRadio [®] and EZRadioPro [®] Transceivers | 7 |
| 3.2 Configuration Summary | 8 |
| 3.3 Memory Map | 9 |
| 4. Electrical Specifications | 10 |
| 4.1 Test Conditions | 10 |
| 4.1.1 Typical Values | 10 |
| 4.1.2 Minimum and Maximum Values | 10 |
| 4.2 Absolute Maximum Ratings | 10 |
| 4.3 Thermal Characteristics | 11 |
| 4.4 General Operating Conditions | 11 |

| | | |
|-----------|--|-----------|
| 4.5 | Current Consumption | .12 |
| 4.6 | Transitions between Energy Modes | .14 |
| 4.7 | Power Management | .14 |
| 4.8 | Flash | .15 |
| 4.9 | General Purpose Input Output | .16 |
| 4.10 | Oscillators | .24 |
| 4.10.1 | LXFO | .24 |
| 4.10.2 | HFXO | .25 |
| 4.10.3 | LFRCO | .26 |
| 4.10.4 | HFRCO | .27 |
| 4.10.5 | AUXHFRCO | .31 |
| 4.10.6 | ULFRCO | .31 |
| 4.11 | Analog Digital Converter (ADC) | .32 |
| 4.11.1 | Typical Performance | .38 |
| 4.12 | Digital Analog Converter (DAC) | .44 |
| 4.13 | Operational Amplifier (OPAMP) | .46 |
| 4.14 | Analog Comparator (ACMP) | .50 |
| 4.15 | Voltage Comparator (VCMP) | .52 |
| 4.16 | I2C | .53 |
| 4.17 | Radio | .54 |
| 4.17.1 | EZRadioPRO (R6x) DC Electrical Characteristics | .55 |
| 4.17.2 | EZRadioPRO (R6x) Synthesizer AC Electrical Characteristics | .56 |
| 4.17.3 | EZRadioPRO (R6x) Receiver AC Electrical Characteristics | .57 |
| 4.17.4 | EZRadioPRO (R6x) Transmitter AC Electrical Characteristics | .60 |
| 4.17.5 | EZRadioPRO (R6x) Radio Auxillary Block Specifications | .61 |
| 4.17.6 | EZRadio (R55) DC Electrical Characteristics | .62 |
| 4.17.7 | EZRadio (R55) Synthesizer AC Electrical Characteristics | .62 |
| 4.17.8 | EZRadio (R55) Receiver AC Electrical Characteristics | .63 |
| 4.17.9 | EZRadio (R55) Transmitter AC Electrical Characteristics | .64 |
| 4.17.10 | EZRadio (R55) Radio Auxiliary Block Specifications | .65 |
| 4.17.11 | EZRadioPRO/EZRadioPRO Digital I/O Specification | .66 |
| 4.18 | Digital Peripherals | .67 |
| 5. | Pinout and Package | 68 |
| 5.1 | Pinout | .68 |
| 5.2 | Pin Descriptions | .69 |
| 5.3 | Alternate Functionality Pinout | .72 |
| 5.4 | GPIO Pinout Overview | .76 |
| 5.5 | Opamp Pinout Overview | .76 |
| 5.6 | QFN64 Package | .77 |
| 6. | PCB Layout and Soldering | 78 |
| 6.1 | Recommended PCB Layout | .78 |
| 6.2 | Soldering Information | .79 |

| | |
|----------------------------|-----------|
| 7. Top Marking. | 80 |
| 8. Revision History | 81 |
| 8.1 Revision History | 81 |
| Table of Contents. | 82 |



Simplicity Studio

One-click access to MCU tools, documentation, software, source code libraries & more. Available for Windows, Mac and Linux!

www.silabs.com/simplicity



MCU Portfolio
www.silabs.com/mcu



SW/HW
www.silabs.com/simplicity



Quality
www.silabs.com/quality



Support and Community
community.silabs.com

Disclaimer

Silicon Laboratories intends to provide customers with the latest, accurate, and in-depth documentation of all peripherals and modules available for system and software implementers using or intending to use the Silicon Laboratories products. Characterization data, available modules and peripherals, memory sizes and memory addresses refer to each specific device, and "Typical" parameters provided can and do vary in different applications. Application examples described herein are for illustrative purposes only. Silicon Laboratories reserves the right to make changes without further notice and limitation to product information, specifications, and descriptions herein, and does not give warranties as to the accuracy or completeness of the included information. Silicon Laboratories shall have no liability for the consequences of use of the information supplied herein. This document does not imply or express copyright licenses granted hereunder to design or fabricate any integrated circuits. The products must not be used within any Life Support System without the specific written consent of Silicon Laboratories. A "Life Support System" is any product or system intended to support or sustain life and/or health, which, if it fails, can be reasonably expected to result in significant personal injury or death. Silicon Laboratories products are generally not intended for military applications. Silicon Laboratories products shall under no circumstances be used in weapons of mass destruction including (but not limited to) nuclear, biological or chemical weapons, or missiles capable of delivering such weapons.

Trademark Information

Silicon Laboratories Inc., Silicon Laboratories, Silicon Labs, SiLabs and the Silicon Labs logo, CMEMS®, EFM, EFM32, EFR, Energy Micro, Energy Micro logo and combinations thereof, "the world's most energy friendly microcontrollers", Ember®, EZLink®, EZMac®, EZRadio®, EZRadioPRO®, DSPLL®, ISOModem®, Precision32®, ProSLIC®, SiPHY®, USBXpress® and others are trademarks or registered trademarks of Silicon Laboratories Inc. ARM, CORTEX, Cortex-M3 and THUMB are trademarks or registered trademarks of ARM Holdings. Keil is a registered trademark of ARM Limited. All other products or brand names mentioned herein are trademarks of their respective holders.



Silicon Laboratories Inc.
400 West Cesar Chavez
Austin, TX 78701
USA

<http://www.silabs.com>



Компания «ЭлектроПласт» предлагает заключение долгосрочных отношений при поставках импортных электронных компонентов на взаимовыгодных условиях!

Наши преимущества:

- Оперативные поставки широкого спектра электронных компонентов отечественного и импортного производства напрямую от производителей и с крупнейших мировых складов;
- Поставка более 17-ти миллионов наименований электронных компонентов;
- Поставка сложных, дефицитных, либо снятых с производства позиций;
- Оперативные сроки поставки под заказ (от 5 рабочих дней);
- Экспресс доставка в любую точку России;
- Техническая поддержка проекта, помощь в подборе аналогов, поставка прототипов;
- Система менеджмента качества сертифицирована по Международному стандарту ISO 9001;
- Лицензия ФСБ на осуществление работ с использованием сведений, составляющих государственную тайну;
- Поставка специализированных компонентов (Xilinx, Altera, Analog Devices, Intersil, Interpoint, Microsemi, Aeroflex, Peregrine, Syfer, Eurofarad, Texas Instrument, Miteq, Cobham, E2V, MA-COM, Hittite, Mini-Circuits, General Dynamics и др.);

Помимо этого, одним из направлений компании «ЭлектроПласт» является направление «Источники питания». Мы предлагаем Вам помощь Конструкторского отдела:

- Подбор оптимального решения, техническое обоснование при выборе компонента;
- Подбор аналогов;
- Консультации по применению компонента;
- Поставка образцов и прототипов;
- Техническая поддержка проекта;
- Защита от снятия компонента с производства.



Как с нами связаться

Телефон: 8 (812) 309 58 32 (многоканальный)

Факс: 8 (812) 320-02-42

Электронная почта: org@eplast1.ru

Адрес: 198099, г. Санкт-Петербург, ул. Калинина, дом 2, корпус 4, литера А.