

## Generation 3

### Sensus™ LED Series

Pure White Targeted COB Arrays  
Below the Black Body Locus (BBBL)



#### Table of Contents

Technology Overview .....2

Test Specifications .....2

Chromaticity Bins .....3

Product Ordering & Shipping  
Part Numbers .....4

Product Typical Flux Range 5

Operating Characteristics ..9

Optical and Electrical Character-  
istics..... 13

Spectra ..... 21

Mechanical Dimensions .. 22

Packaging Information ... 23

Handing notes ..... 31

#### Features:

- Matching the human perception of “Pure white” light
- Designed to provide the look and feel of ceramic metal halide lights
- Wide product range from 1,000lm to over 10,000lm
- 3000K and 3500K, 80 and 90CRI standard
- Highly saturated color rendering version in 3000K and 3500K
- 3 SDCM color binning accuracy
- Excellent optical emission uniformity and color over angle consistency
- Exceptional long term color stability
- Package thermal conductivity more than the industry average
- Environmentally friendly: RoHS and REACH compliant
- UL Recognized, File # E465703



#### Applications

- Retail Shop Lighting
- Spotlights/Track Lights
- CMH replacement LED lamps
- Halogen replacement LED lamps
- Hospitality Lighting
- Architectural and Specialty

## Technology Overview

Luminus Chip-on-Board (COB) LED series offers a complete lighting class solution designed for high performance illumination applications. The Sensus LED series has been specially design for retail shop lighting where enhanced red coloring is a preferred lighting standard. The selection covers a wide lumen range from less than 500lm to over 10,000lm, and is focused on the major market color and CRI of 3000K and both 80 and 90 CRI. These breakthroughs allow illumination engineers and designers to develop beautifully lit spaces without sacrificing efficacy, brightness and overall quality.

### Reliability

Designed from the ground up, the Luminus COB LED is one of the most reliable light sources in the world today. Having passed a rigorous suite of environmental and mechanical stress tests, including mechanical shock, vibration, temperature cycling and humidity. Only then are the devices qualified for use in a wide range of lighting application including some of the most demanding commercial applications. Delivered with fully qualified LM-80 test data and TM-21 lifetime results that certify lumen maintenance at 35,000 hours or more, Luminus COB LEDs are ready for the toughest challenges.

### UL Recognized Compliance

Luminus COB arrays are tested in accordance with ANSI/UL 8750 to ensure safe operation for their intended applications.

### REACH & RoHS Compliance

All LED products manufactured by Luminus are REACH and RoHS compliant and free of hazardous materials, including lead and mercury.

## Understanding Luminus COB LED Test Specifications

Every Luminus LED is fully tested to ensure it meets the high quality standards customers have come to expect from Luminus' products.

### Traceability

Each Luminus COB LED is marked with a 2D bar code that contains a unique serial number. With this serial number, Luminus has the ability to provide customers with actual test data measurements for a specific LED. In addition, the 2D bar code is linked to manufacturing date codes that enables traceability of production processes and materials.

### Chromaticity Bin Range

Chromaticity binning delivers color consistency for every order. Standard products are delivered with a 3-step MacAdam ellipse. This ensures color performance matching in the application. For the most demanding application, Luminus is one of only a few companies that can provide a 2 SDCM. These tightly controlled, small distribution bins provide customers predictable, repeatable colors.

### Testing Temperature

Luminus COB products are measured at temperatures typical for the LED operating in the fixture. Each device is tested at 85°C junction temperature eliminating the need to scale data sheet specifications to real world situations.

### Chromaticity Bin Structure

Chromaticity Bins: 1931 CIE Curve



### Sensus™ LED White Chromaticity Bins

The following tables describe the ANSI bin center points, the orientation angle for the MacAdam ellipse ( $\theta^\circ$ ), and the maximum radii for the ellipses. The ANSI Bin is provided for reference.

Description	CCT	Center Point		3-step Bin		
		CIE <sub>x</sub>	CIE <sub>y</sub>	$\theta^\circ$	a	b
Standard	3000K	0.4252	0.3877	53.6	0.00834	0.00408
Xtreme		0.4210	0.3720	53.2		
Standard	3500K	0.4067	0.3845	54	0.00927	0.00414
Xtreme		0.3980	0.3660	54		

\*Note: Luminus maintains a +/- 0.005 tolerance on chromaticity (CIE<sub>x</sub> and CIE<sub>y</sub>) measurements.

**Product Ordering and Shipping Part Number Nomenclature**

All Sensus LED products are packaged and labeled with part numbers as outlined in the table on page 5. Luminus will include any smaller chromaticity bin that is contained in the larger bin as part of the ordered part. When shipped, each package will contain only a single flux and chromaticity bin. The part number designation is as follows:

**CXM — XX — 30 — 80 — 36 — QQPP — FG — W**

Product Family	Light Emitting Surface Diameter <sup>1</sup>	Color Temperature <sup>2</sup>	Color Rendering Index (CRI) <sup>3</sup>	Voltage (typical)	Package Configurator	Flux Bin	Chromaticity Bin
CIM/ CLM/ CXM: Chip on Board	XX: LES Diameter (mm) Approximate	CCT	XX	Volts Also 54V in some cases	AA32 (Basic package)	Lumens	See page 3 for bins

Note 1: XX nomenclature corresponds to the following:

- 9 = 9.6 mm
- 11 = 11.6 mm
- 14 = 14.3 mm
- 18 = 17.5 mm
- 22 = 22 mm
- 27 = 26.5 mm

Note 2: CT Nomenclature corresponds to the following

- 30 is 3000K
- 35 is 3500K

Note 3: XX Color Rendering nomenclature corresponds to the following

- 80 = 80 CRI
- 90 = 90 CRI

Note 4: AA32 is the Standard Sensus and a standard substrate size

AA34 is the Xtreme Sensus and a standard substrate size

AC32 and XD22 is the Standard Sensus and alternative substrate size

AC34 is the Xtreme Sensus and an alternative substrate size

**Color Temperature, CRI and R9 Values**

Color Temperatures	XX Value	CRI	R9
3000K, 3500K	80	>80	>0
	90	>90	>50

Note: Luminus part numbers may be accompanied by prefixes or suffixes. The most common is the “Rev01” suffix indicating a part is fully released and carries a full warranty. These additional characters may appear on shipping labels, packing slips and invoices. In all cases the basic part number described above will always be included.

**Sensus™ LED Series Part Numbers**

The following tables describe products with typical flux and minimum flux measured at typical currents and specified at 85°C. The values at 25°C are calculated and shown for reference only. All product is measured and specified at 85°C junction temperature.

Output Flux (lm)			LES Diameter (mm)	Typ. Current (mA)	Ordering Part Number
Typ. (85°C)	Min. (85°C)	Typ. (calculated) (25°C)			3 SDCM
665	620	715	6.3	150	CXM-6-30-80-36-AA32-F4-3
560	525	605			CXM-6-30-90-36-AA32-F4-3
685	635	735			CXM-6-35-80-36-AA32-F4-3
570	530	615			CXM-6-35-90-36-AA32-F4-3
665	620	715			CXM-6-30-80-36-AC32-F4-3
560	525	605			CXM-6-30-90-36-AC32-F4-3
685	635	735			CXM-6-35-80-36-AC32-F4-3
570	530	615			CXM-6-35-90-36-AC32-F4-3
665	620	715	6.3	300	CXM-6-30-80-18-AA32-F4-3
560	525	605			CXM-6-30-90-18-AA32-F4-3
685	635	735			CXM-6-35-80-18-AA32-F4-3
570	530	615			CXM-6-35-90-18-AA32-F4-3
860	800	925	9.6	180	CIM-9-30-80-36-AC32-F4-3
720	670	780			CIM-9-30-90-36-AC32-F4-3
885	820	955			CIM-9-35-80-36-AC32-F4-3
735	685	795			CIM-9-35-90-36-AC32-F4-3
1,155	1,075	1,245	9.6	240	CLM-9-30-80-36-AA32-F4-3
970	905	1,050			CLM-9-30-90-36-AA32-F4-3
1,190	1,105	1,285			CLM-9-35-80-36-AA32-F4-3
990	920	1,070			CLM-9-35-90-36-AA32-F4-3
1,155	1,075	1,245			CLM-9-30-80-36-AC32-F4-3
970	905	1,050			CLM-9-30-90-36-AC32-F4-3
1,190	1,105	1,285			CLM-9-35-80-36-AC32-F4-3
990	920	1,070			CLM-9-35-90-36-AC32-F4-3

\*Note: Luminus maintains a +/- 6% tolerance on flux measurements.

Luminus maintains a +/- 2% tolerance on CRI measurements.

**Sensus™ LED Series Part Numbers**

The following tables describe products with typical flux and minimum flux measured at typical currents and specified at 85°C. The values at 25°C are calculated and shown for reference only. All product is measured and specified at 85°C junction temperature.

Output Flux (lm)			LES Diameter (mm)	Typ. Current (mA)	Ordering Part Number
Typ. (85°C)	Min. (85°C)	Typ. (calculated) (25°C)			3 SDCM
1,690	1,570	1,860	9.6	360	CXM-9-30-80-36-AC32-F4-3
1,425	1,325	1,565			CXM-9-30-90-36-AC32-F4-3
1,745	1,620	1,915			CXM-9-35-80-36-AC32-F4-3
1,450	1,350	1,595			CXM-9-35-90-36-AC32-F4-3
1,605	1,490	1,735	9.6	360	CHM-9-30-80-36-XD22-F4-3
1,350	1,255	1,455			CHM-9-30-90-36-XD22-F4-3
1,655	1,540	1,780			CHM-9-35-80-36-XD22-F4-3
1,380	1,285	1,485			CHM-9-35-90-36-XD22-F4-3
2,165	1,990	2,315	11.6	450	CXM-11-30-80-36-AA32-F4-3
1,820	1,675	1,950			CXM-11-30-90-36-AA32-F4-3
2,230	2,050	2,385			CXM-11-35-80-36-AA32-F4-3
1,860	1,710	1,985			CXM-11-35-90-36-AA32-F4-3
2,165	1,990	2,315			CXM-11-30-80-36-AC32-F4-3
1,820	1,675	1,950			CXM-11-30-90-36-AC32-F4-3
2,230	2,050	2,385			CXM-11-35-80-36-AC32-F4-3
1,860	1,710	1,985			CXM-11-35-90-36-AC32-F4-3
2,215	2,055	2,390	14.3	450	CIM-14-30-80-36-AC32-F4-3
1,860	1,735	2,010			CIM-14-30-90-36-AC32-F4-3
2,280	2,125	2,460			CIM-14-35-80-36-AC32-F4-3
1,900	1,765	2,050			CIM-14-35-90-36-AC32-F4-3
2,415	2,235	2,590	14.3	500	CLM-14-30-80-36-AA32-F4-3
2,030	1,875	2,180			CLM-14-30-90-36-AA32-F4-3
2,480	2,300	2,670			CLM-14-35-80-36-AA32-F4-3
2,065	1,915	2,225			CLM-14-35-90-36-AA32-F4-3
2,415	2,235	2,590			CLM-14-30-80-36-AC32-F4-3
2,030	1,875	2,180			CLM-14-30-90-36-AC32-F4-3
2,480	2,300	2,670			CLM-14-35-80-36-AC32-F4-3
2,065	1,915	2,225			CLM-14-35-90-36-AC32-F4-3

\*Note: Luminus maintains a +/- 6% tolerance on flux measurements.  
Luminus maintains a +/- 2% tolerance on CRI measurements.

**Sensus™ LED Series Part Numbers**

The following tables describe products with typical flux and minimum flux measured at typical currents and specified at 85°C. The values at 25°C are calculated and shown for reference only. All product is measured and specified at 85°C junction temperature.

Output Flux (lm)			LES Diameter (mm)	Typ. Current (mA)	Ordering Part Number
Typ. (85°C)	Min. (85°C)	Typ. (calculated) (25°C)			3 SDCM
3,420	3,120	3,620	14.3	720	CXM-14-30-80-36-AA32-F4-3
2,880	2,620	3,050			CXM-14-30-90-36-AA32-F4-3
3,525	3,210	3,730			CXM-14-35-80-36-AA32-F4-3
2,935	2,675	3,105			CXM-14-35-90-36-AA32-F4-3
3,420	3,120	3,620			CXM-14-30-80-36-AC32-F4-3
2,880	2,620	3,050			CXM-14-30-90-36-AC32-F4-3
3,525	3,210	3,730			CXM-14-35-80-36-AC32-F4-3
2,935	2,675	3,105			CXM-14-35-90-36-AC32-F4-3
4,375	4,070	4,725	17.5	900	CXM-18-30-80-36-AA32-F4-3
3,680	3,420	3,975			CXM-18-30-90-36-AA32-F4-3
4,505	4,190	4,865			CXM-18-35-80-36-AA32-F4-3
3,750	3,490	4,055			CXM-18-35-90-36-AA32-F4-3
5465	5085	5895	22	1,100	CLM-22-30-80-36-AC32-F4-3
4595	4275	4955			CLM-22-30-90-36-AC32-F4-3
5625	5230	6065			CLM-22-35-80-36-AC32-F4-3
4690	4360	5060			CLM-22-35-90-36-AC32-F4-3
7,870	7,320	8,505	22	1,100	CXM-22-30-80-54-AC32-F4-3
6,620	6,155	7,150			CXM-22-30-90-54-AC32-F4-3
8,105	7,540	8,755			CXM-22-35-80-54-AC32-F4-3
6,750	6,280	7,290			CXM-22-35-90-54-AC32-F4-3
11,780	10,955	12,720	26.5	1,600	CXM-27-30-80-54-AB32-F4-3
9,910	9,215	10,700			CXM-27-30-90-54-AB32-F4-3
12,130	11,280	13,100			CXM-27-35-80-54-AB32-F4-3
10,110	9,400	10,915			CXM-27-35-90-54-AB32-F4-3

\*Note: Luminus maintains a +/- 6% tolerance on flux measurements.

Luminus maintains a +/- 2% tolerance on CRI measurements.

**Xtreme Sensus™ LED Series Part Numbers**

The following tables describe products with typical flux and minimum flux measured at typical currents and specified at 85°C. The values at 25°C are calculated and shown for reference only. All product is measured and specified at 85°C junction temperature.

Output Flux (lm)			LES Diameter (mm)	Typ. Current (mA)	Ordering Part Number
Typ. (85°C)	Min. (85°C)	Typ. (calculated) (25°C)			3 SDCM
620	580	670	9.6	180	CIM-9-30-90-36-AC34-F4-3
635	590	685			CIM-9-35-90-36-AC34-F4-3
1,235	1,150	1,240	9.6	360	CXM-9-30-90-36-AC34-F4-3
1,260	1,170	1,260			CXM-9-35-90-36-AC34-F4-3
1,580	1,470	1,585	11.6	450	CXM-11-30-90-36-AC34-F4-3
1,615	1,500	1,620			CXM-11-35-90-36-AC34-F4-3
1,580	1,470	1,585			CXM-11-30-90-36-AA34-F4-3
1,615	1,500	1,620			CXM-11-35-90-36-AA34-F4-3
1,605	1,495	1,735	14.3	450	CIM-14-30-90-36-AC34-F4-3
1,640	1,520	1,765			CIM-14-35-90-36-AC34-F4-3
1,640	1,520	1,765	14.3	500	CLM-14-30-90-36-AC34-F4-3
1,670	1,555	1,800			CLM-14-35-90-36-AC34-F4-3
1,640	1,520	1,765			CLM-14-30-90-36-AA34-F4-3
1,670	1,555	1,800			CLM-14-35-90-36-AA34-F4-3
2,520	2,345	2,530	14.3	720	CXM-14-30-90-36-AC34-F4-3
2,570	2,390	2,580			CXM-14-35-90-36-AC34-F4-3
2,520	2,345	2,530			CXM-14-30-90-36-AA34-F4-3
2,570	2,390	2,580			CXM-14-35-90-36-AA34-F4-3
3,575	3,325	3,590	17.5	900	CXM-18-30-90-36-AA34-F4-3
3,645	3,390	3,660			CXM-18-35-90-36-AA34-F4-3
3,750	3,490	3,765	22	1100	CLM-22-30-90-36-AC34-F4-3
3,830	3,565	3,845			CLM-22-35-90-36-AC34-F4-3

\*Note: Luminus maintains a +/- 6% tolerance on flux measurements.

Luminus maintains a +/- 2% tolerance on CRI measurements.



**CXM-6 Operating Characteristics<sup>1</sup>**
**Optical and Electrical Characteristics**

Parameter	Symbol	Minimum	Typical	Maximum	Unit
Forward Current (36V) <sup>2</sup>	$I_f$		150	325	mA
Forward Current (18V) <sup>2</sup>	$I_f$		300	650	mA
Forward Voltage (36V) <sup>3</sup>	$V_f$	31	34.6	37	V
Forward Voltage(18V) <sup>3</sup>	$V_f$	15.5	17.3	18.5	V
Power			5.2	11.8	W
Operating Case Temperature <sup>4</sup>	$T_c$			105	°C
Light Emitting Surface Diameter	LES		6.3		mm
Thermal Resistance (junction-to-case)	$\Theta_{jc}$		0.96		°C/W
Junction Temperature	$T_j$			140	°C
Viewing Angle			120		Degree

**CIM-9 Operating Characteristics<sup>1</sup>**
**Optical Characteristics**

Parameter	Symbol	Minimum	Typical	Maximum	Unit
Forward Current <sup>2</sup>	$I_f$		180	360	mA
Forward Voltage <sup>3</sup>	$V_f$	31.8	33.8	35.8	V
Power			6.1	13.2	W
Operating Case Temperature <sup>4</sup>	$T_c$			105	°C
Light Emitting Surface Diameter	LES		9.6		mm
Thermal Resistance (junction-to-case)	$\Theta_{jc}$		0.9		°C/W
Junction Temperature	$T_j$			140	°C
Viewing Angle			120		Degree

**CLM-9 Operating Characteristics<sup>1</sup>**
**Optical and Electrical Characteristics**

Parameter	Symbol	Minimum	Typical	Maximum	Unit
Forward Current <sup>2</sup>	$I_f$		240	540	mA
Forward Voltage <sup>3</sup>	$V_f$	31	33.8	37	V
Power			8.2	20	W
Operating Case Temperature <sup>4</sup>	$T_c$			105	°C
Light Emitting Surface Diameter	LES		9.6		mm
Thermal Resistance (junction-to-case)	$\Theta_{jc}$		0.65		°C/W
Junction Temperature	$T_j$			140	°C
Viewing Angle			120		Degree

**CXM-9 Operating Characteristics<sup>1</sup>**
**Optical and Electrical Characteristics**

Parameter	Symbol	Minimum	Typical	Maximum	Unit
Forward Current <sup>2</sup>	$I_f$		360	720	mA
Forward Voltage <sup>3</sup>	$V_f$	31	34	37	V
Power			12.2	27	W
Operating Case Temperature <sup>4</sup>	$T_c$			100	°C
Light Emitting Surface Diameter	LES		9.6		mm
Thermal Resisittance (junction-to-case)	$\Theta_{jc}$		0.5		°C/W
Junction Temperature	$T_j$			140	°C
Viewing Angle			120		Degree

**CHM-9 Operating Characteristics<sup>1</sup>**
**Optical and Electrical Characteristics**

Parameter	Symbol	Minimum	Typical	Maximum	Unit
Forward Current <sup>2</sup>	$I_f$		360	960	mA
Forward Voltage <sup>3</sup>	$V_f$	31	34	37	V
Power			12.2	37.4	W
Operating Case Temperature <sup>4</sup>	$T_c$			105	°C
Light Emitting Surface Diameter	LES		9.6		mm
Thermal Resisittance (junction-to-case)	$\Theta_{jc}$		0.5		°C/W
Junction Temperature	$T_j$			140	°C
Viewing Angle			120		Degree

**CXM-11 Operating Characteristics<sup>1</sup>**
**Optical and Electrical Characteristics**

Parameter	Symbol	Minimum	Typical	Maximum	Unit
Forward Current <sup>2</sup>	$I_f$		450	1,080	mA
Forward Voltage <sup>3</sup>	$V_f$	31	33.8	37	V
Power			15.2	40.5	W
Operating Case Temperature <sup>4</sup>	$T_c$			105	°C
Light Emitting Surface Diameter	LES		11.6		mm
Thermal Resisittance (junction-to-case)	$\Theta_{jc}$		0.35		°C/W
Junction Temperature	$T_j$			140	°C
Viewing Angle			120		Degree

**CIM-14 Operating Characteristics<sup>1</sup>**

**Optical and Electrical Characteristics**

Parameter	Symbol	Minimum	Typical	Maximum	Unit
Forward Current <sup>2</sup>	$I_f$		450	1,080	mA
Forward Voltage <sup>3</sup>	$V_f$	31	34	37	V
Power			15	40	W
Operating Case Temperature <sup>4</sup>	$T_c$			105	°C
Light Emitting Surface Diameter	LES		14.3		mm
Thermal Resisitance (junction-to-case)	$\Theta_{jc}$		0.32		°C/W
Junction Temperature	$T_j$			140	°C
Viewing Angle			120		Degree

**CLM-14 Operating Characteristics<sup>1</sup>**

**Optical and Electrical Characteristics**

Parameter	Symbol	Minimum	Typical	Maximum	Unit
Forward Current <sup>2</sup>	$I_f$		500	1,260	mA
Forward Voltage <sup>3</sup>	$V_f$	31	33.8	37	V
Power			17	47	W
Operating Case Temperature <sup>4</sup>	$T_c$			105	°C
Light Emitting Surface Diameter	LES		14.3		mm
Thermal Resisitance (junction-to-case)	$\Theta_{jc}$		0.31		°C/W
Junction Temperature	$T_j$			140	°C
Viewing Angle			120		Degree

**CXM-14 Operating Characteristics<sup>1</sup>**
**Optical and Electrical Characteristics**

Parameter	Symbol	Minimum	Typical	Maximum	Unit
Forward Current <sup>2</sup>	$I_f$		720	1,440	mA
Forward Voltage <sup>3</sup>	$V_f$	31	34	37	V
Power			24.5	54	W
Operating Case Temperature <sup>4</sup>	$T_c$			105	°C
Light Emitting Surface Diameter	LES		14.3		mm
Thermal Resisittance (junction-to-case)	$\Theta_{jc}$		0.27		°C/W
Junction Temperature	$T_j$			140	°C
Viewing Angle			120		Degree

**CXM-18 Operating Characteristics<sup>1</sup>**
**Optical and Electrical Characteristics**

Parameter	Symbol	Minimum	Typical	Maximum	Unit
Forward Current <sup>2</sup>	$I_f$		900	1,800	mA
Forward Voltage <sup>3</sup>	$V_f$	31	34	37	V
Power			30.6	64	W
Operating Case Temperature <sup>4</sup>	$T_c$			105	°C
Light Emitting Surface Diameter	LES		17.5		mm
Thermal Resisittance (junction-to-case)	$\Theta_{jc}$		0.21		°C/W
Junction Temperature	$T_j$			140	°C
Viewing Angle			120		Degree

**CLM-22 Operating Characteristics<sup>1</sup>**
**Optical and Electrical Characteristics**

Parameter	Symbol	Minimum	Typical	Maximum	Unit
Forward Current <sup>2</sup>	$I_f$		1,100	2,200	mA
Forward Voltage <sup>3</sup>	$V_f$	31	33.8	37	V
Power			37.2	82	W
Operating Case Temperature <sup>4</sup>	$T_c$			105	°C
Light Emitting Surface Diameter	LES		22		mm
Thermal Resisittance (junction-to-case)	$\Theta_{jc}$		0.19		°C/W
Junction Temperature	$T_j$			140	°C
Viewing Angle			120		Degree

**CXM-22 Operating Characteristics<sup>1</sup>**
**Optical and Electrical Characteristics**

Parameter	Symbol	Minimum	Typical	Maximum	Unit
Forward Current <sup>2</sup>	$I_f$		1,100	2,200	mA
Forward Voltage <sup>3</sup>	$V_f$	50	51	55	V
Power			56.1	125	W
Operating Case Temperature <sup>4</sup>	$T_c$			105	°C
Light Emitting Surface Diameter	LES		22		mm
Thermal Resisitance (junction-to-case)	$\Theta_{jc}$		0.17		°C/W
Junction Temperature	$T_j$			140	°C
Viewing Angle			120		Degree

**CXM-27 Operating Characteristics<sup>1</sup>**
**Optical and Electrical Characteristics**

Parameter	Symbol	Minimum	Typical	Maximum	Unit
Forward Current <sup>2</sup>	$I_f$		1,600	3,200	mA
Forward Voltage <sup>3</sup>	$V_f$	48	51	56	V
Power			82	180	W
Operating Case Temperature <sup>4</sup>	$T_c$			105	°C
Light Emitting Surface Diameter	LES		26.5		mm
Thermal Resisitance (junction-to-case)	$\Theta_{jc}$		0.15		°C/W
Junction Temperature	$T_j$			140	°C
Viewing Angle			120		Degree

**Operating Characteristics Notes**

- Note 1: Ratings are based on operation at a constant junction temperature  $T_j = 85^\circ\text{C}$ .
- Note 2: To prevent damage refer to operating conditions and derating curves for appropriate maximum operating conditions
- Note 3: Forward voltage is rated at typical forward current. For voltage at different forward currents, refer to the voltage versus current performance graphs.
- Note 4: COB LEDs are designed for operation to a minimum of 20% of the typical forward current value. Operation at currents lower than this value will not harm the device but may result in uneven light emission across the LES surface.
- Note 5: Luminus may change any specifications without prior notice. Please refer to the company web site for the latest data sheet revision
- Note 6: Caution must be taken not to stare at the light emitted from these LEDs. Under special circumstances, the high intensity could damage the eye.

**CXM-6, 36V Optical & Electrical Characteristics**
**Relative Output Flux vs. Forward Current @ 85°C**

**Forward Current vs. Forward Voltage @ 85°C**

**Relative Output Flux vs. Junction Temperature**

**Change in Voltage vs. Junction Temperature**

**CXM-6, 18V Optical & Electrical Characteristics**
**Relative Output Flux vs. Forward Current @ 85°C**

**Forward Current vs. Forward Voltage @ 85°C**

**CXM-6, 18V Optical & Electrical Characteristics**
**Relative Output Flux vs. Junction Temperature**

**Change in Voltage vs. Junction Temperature**

**CIM-9 Optical & Electrical Characteristics**
**Relative Output Flux vs. Forward Current @ 85°C**

**Forward Current vs. Forward Voltage @ 85°C**

**Relative Output Flux vs. Junction Temperature**

**Change in Voltage vs. Junction Temperature**

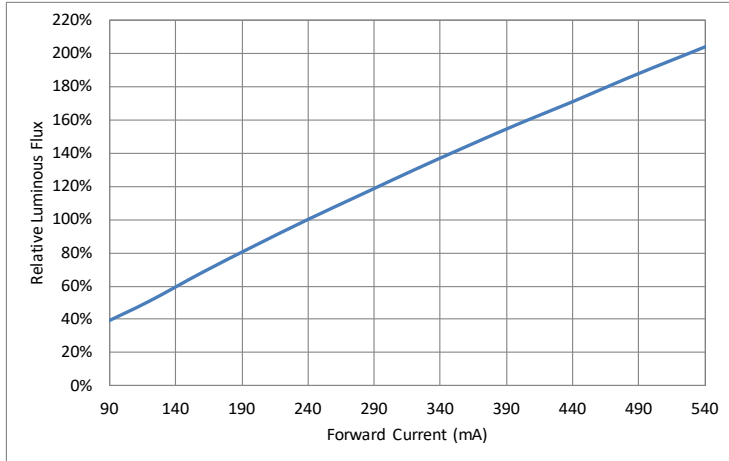
**CLM-9 Optical & Electrical Characteristics**
**Relative Output Flux vs. Forward Current @ 85°C**

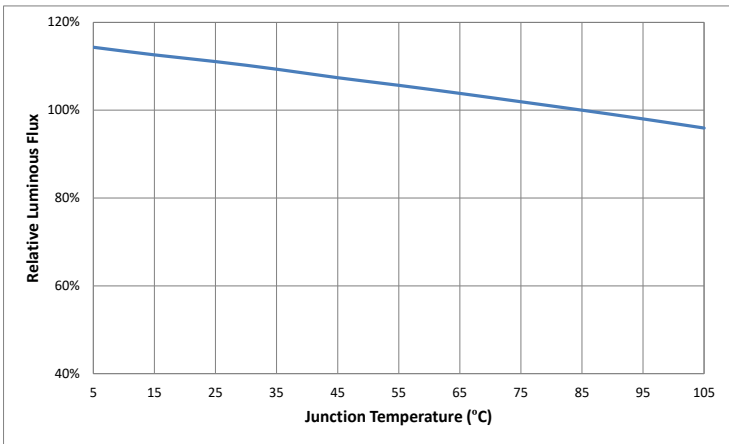
**Forward Current vs. Forward Voltage @ 85°C**

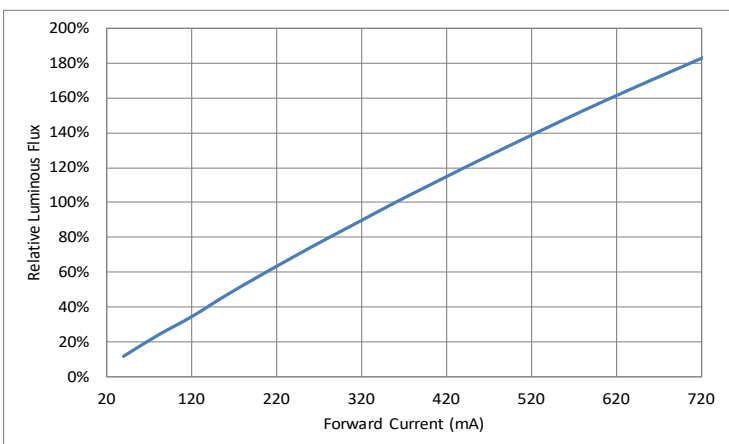
**Relative Output Flux vs. Junction Temperature**

**Change in Voltage vs. Junction Temperature**

**CXM-9 Optical & Electrical Characteristics**
**Relative Output Flux vs. Forward Current @ 85°C**

**Forward Current vs. Forward Voltage @ 85°C**



**CXM-9 Optical & Electrical Characteristics**
**Relative Output Flux vs. Junction Temperature**

**Change in Voltage vs. Junction Temperature**

**CHM-9 Optical & Electrical Characteristics**
**Relative Output Flux vs. Forward Current @ 85°C**

**Forward Current vs. Forward Voltage @ 85°C**

**Relative Output Flux vs. Junction Temperature**

**Change in Voltage vs. Junction Temperature**

**CXM-11 Optical & Electrical Characteristics**

**Relative Output Flux vs. Forward Current @ 85°C**

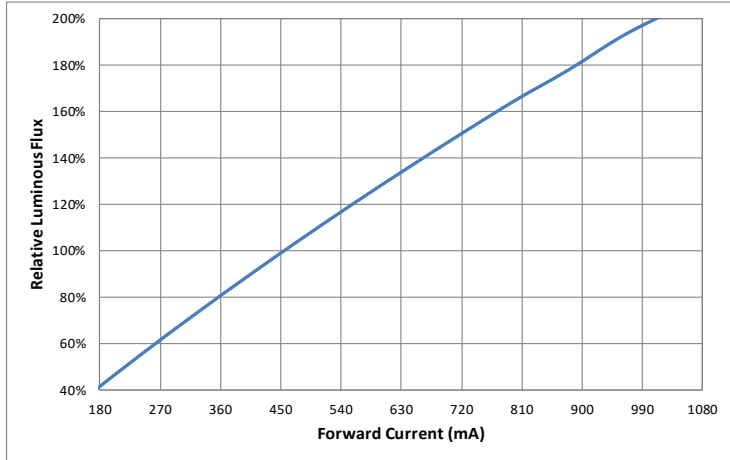

**Forward Current vs. Forward Voltage @ 85°C**



**Relative Output Flux vs. Junction Temperature**

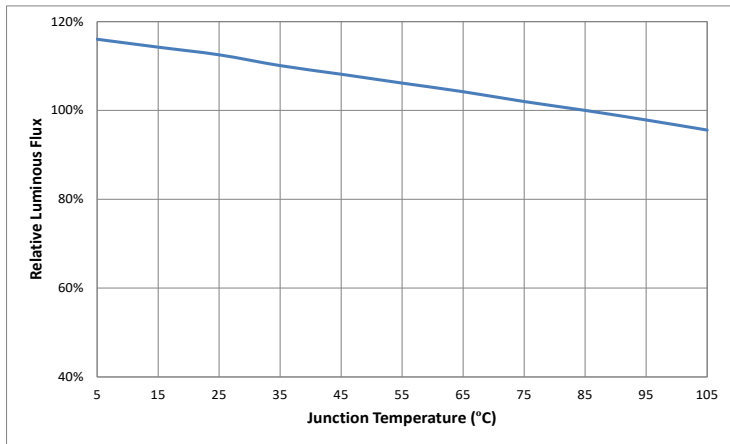

**Change in Voltage vs. Junction Temperature**



**CIM-14 Optical & Electrical Characteristics**

**Relative Output Flux vs. Forward Current @ 85°C**

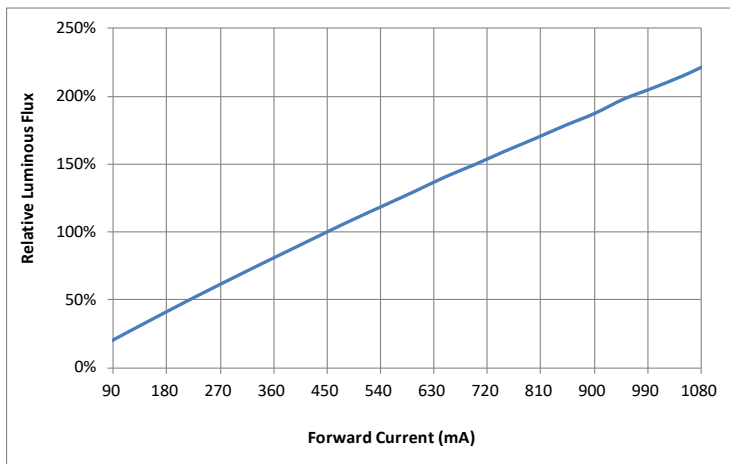

**Forward Current vs. Forward Voltage @ 85°C**

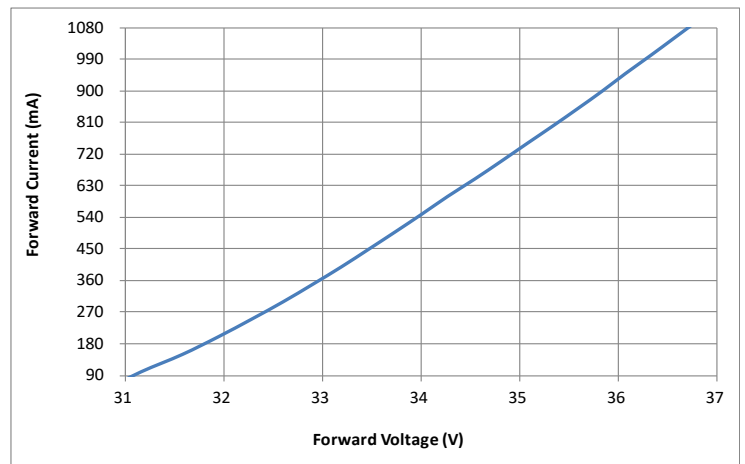

**CIM-14 Optical & Electrical Characteristics**
**Relative Output Flux vs. Junction Temperature**

**Change in Voltage vs. Junction Temperature**

**CLM-14 Optical & Electrical Characteristics**
**Relative Output Flux vs. Forward Current @ 85°C**

**Forward Current vs. Forward Voltage @ 85°C**

**Relative Output Flux vs. Junction Temperature**

**Change in Voltage vs. Junction Temperature**

**CXM-14 Optical & Electrical Characteristics**
**Relative Output Flux vs. Forward Current @ 85°C**

**Forward Current vs. Forward Voltage @ 85°C**

**Relative Output Flux vs. Junction Temperature**

**Change in Voltage vs. Junction Temperature**

**CXM-18 Optical & Electrical Characteristics**
**Relative Output Flux vs. Forward Current @ 85°C**

**Forward Current vs. Forward Voltage @ 85°C**

**CXM-18 Optical & Electrical Characteristics**
**Relative Output Flux vs. Junction Temperature**

**Change in Voltage vs. Junction Temperature**

**CLM-22 Optical & Electrical Characteristics**
**Relative Output Flux vs. Forward Current @ 85°C**

**Forward Current vs. Forward Voltage @ 85°C**

**Relative Output Flux vs. Junction Temperature**

**Change in Voltage vs. Junction Temperature**

**CXM-22 Optical & Electrical Characteristics**
**Relative Output Flux vs. Forward Current @ 85°C**

**Forward Current vs. Forward Voltage @ 85°C**

**Relative Output Flux vs. Junction Temperature**

**Change in Voltage vs. Junction Temperature**

**CXM-27 Optical & Electrical Characteristics**
**Relative Output Flux vs. Forward Current @ 85°C**

**Forward Current vs. Forward Voltage @ 85°C**

**Relative Output Flux vs. Junction Temperature**

**Change in Voltage vs. Junction Temperature**

**Optical & Electrical Characteristics**
**Typical Spectrum**

**Change CIE<sub>x</sub> vs. Junction Temperature (3000K, 80CRI)**

**Change CIE<sub>y</sub> vs. Junction Temperature (3000K, 80CRI)**

**Typical Polar Radiation Pattern**

**Typical Angular Radiation Pattern**





**Mechanical Dimensions (CXM-6-AA)**

**Mechanical Dimensions (CXM-6-AC)**

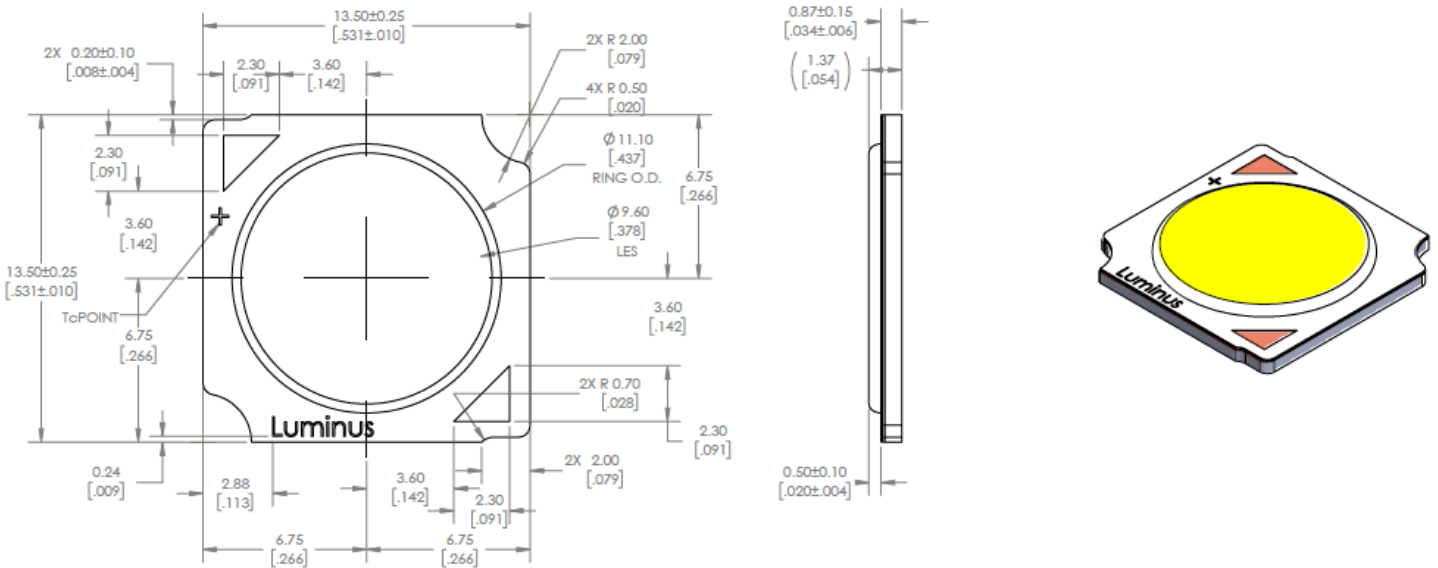
Mechanical Dimensions (CIM/ CLM/CXM-9 -AC)

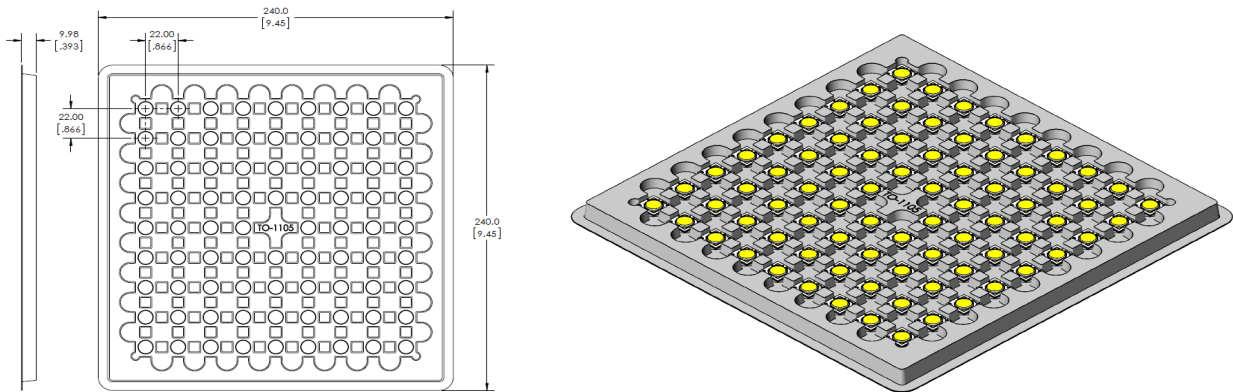

Shipping Container (CXM-6-AA/ AC & CIM/ CLM/ CXM-9-AC)



400 pcs per box  
Each bag is boxed for easier storage/ stacking

Trays are sealed in an anti-static bag

80 pcs per tray  
5 trays are stacked together with separate cover

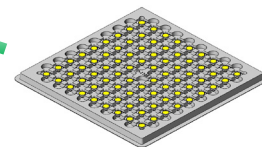

Luminus Label Model:

	<b>LUMINUS</b>	<b>Luminus Devices Inc</b>	RoHS Compliant
XXXXXX-XX-XX (Manufacturer Part Number & Bin Kits)		Rev XX	
Bar code		Bar code	
XXX-XX-XX-XX-XX-XXXX-XX-X (Customer Part Number)		Qty: XX	
XXXXXXXXXXXXXXXX (Box ID)		Bar code	

Mechanical Dimensions (CLM-9-AA/ CHM-9-XD)



Shipping Container (CLM-9-AA/ CHM-9-XD)



300 pcs per box  
Each bag is boxed for easier storage/ stacking

Trays are sealed in an anti-static bag

60 pcs per tray  
5 trays are stacked together with separate cover



Luminus Label Model:

	<b>LUMINUS</b>	<b>Luminus Devices Inc</b>	<b>RoHS Compliant</b>
XXXXXX-XX-XX (Manufacturer Part Number & Bin Kits)	Rev XX	Bar code	
XXX-XX-XX-XX-XX-XXXX-XX-X (Customer Part Number)	Qty: XX	Bar code	
XXXXXXXXXXXXXXXX (Box ID)	Bar code	Bar code	



**Mechanical Dimensions (CXM-11-AA)**

**Mechanical Dimensions (CLM/CXM-14-AA)**

**Shipping Container (CXM-11 & CIM/ CLM/CXM-14)**

**225 pcs per box**  
Each bag is boxed for easier storage/ stacking



Trays are sealed in an anti-static bag



**45 pcs per tray**  
5 trays are stacked together with separate cover



**Luminus Label Model:**

 <b>LUMINUS</b>	<b>Luminus Devices Inc</b>	<b>RoHS Compliant</b>
XXXXXX-XX-XX (Manufacturer Part Number & Bin Kits)	Rev XX	
<input type="text" value="Bar code"/>	<input type="text" value="Bar code"/>	
XXX-XX-XX-XX-XX-XXXX-XX-X (Customer Part Number)		
XXXXXXXXXXXXXXXX (Box ID)	Qty: XX	
<input type="text" value="Bar code"/>	<input type="text" value="Bar code"/>	



### Mechanical Dimensions (CXM-18)

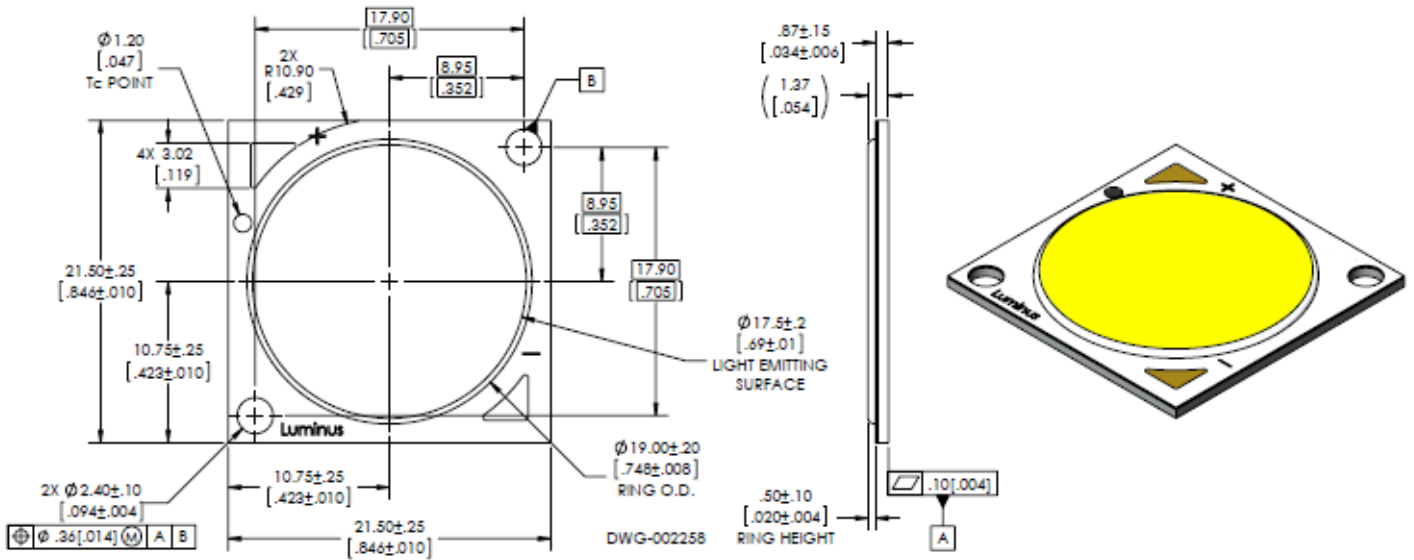

### Shipping Container (CXM-18)

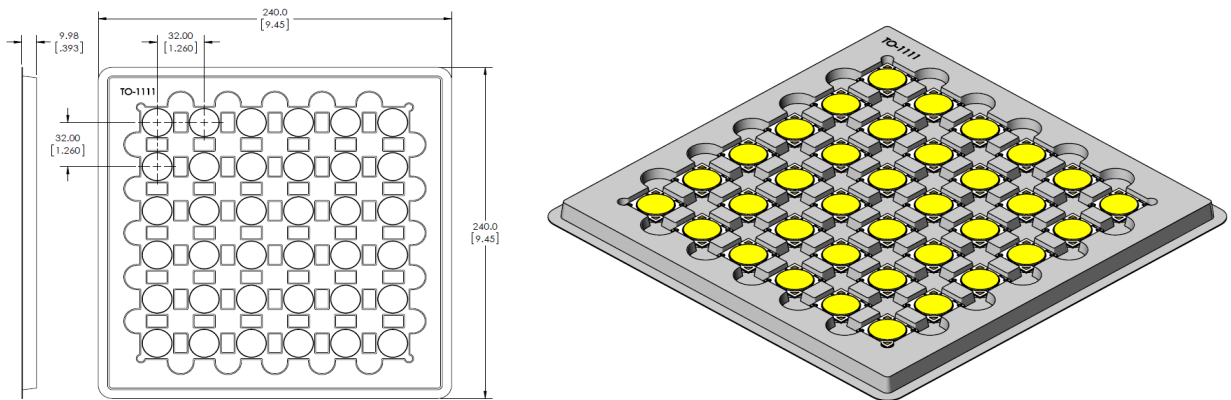

180 pcs per box  
Each bag is boxed for easier storage/ stacking

Trays are sealed in an anti-static bag

36 pcs per tray  
5 trays are stacked together with separate cover

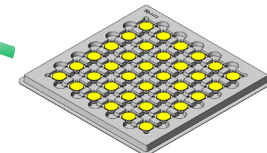
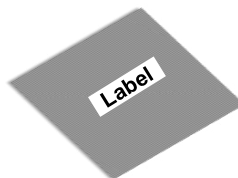

Luminus Label Model:

	<b>LUMINUS</b>	<b>Luminus Devices Inc</b>	RoHS Compliant
XXXXXX-XX-XX (Manufacturer Part Number & Bin Kits)	Rev XX		
Bar code	Bar code		
XXX-XX-XX-XX-XX-XXXX-XX-X (Customer Part Number)			
XXXXXXXXXXXXXXXXXX (Box ID)	Qty: XX		
Bar code	Bar code		





### Mechanical Dimensions (CXM-27)

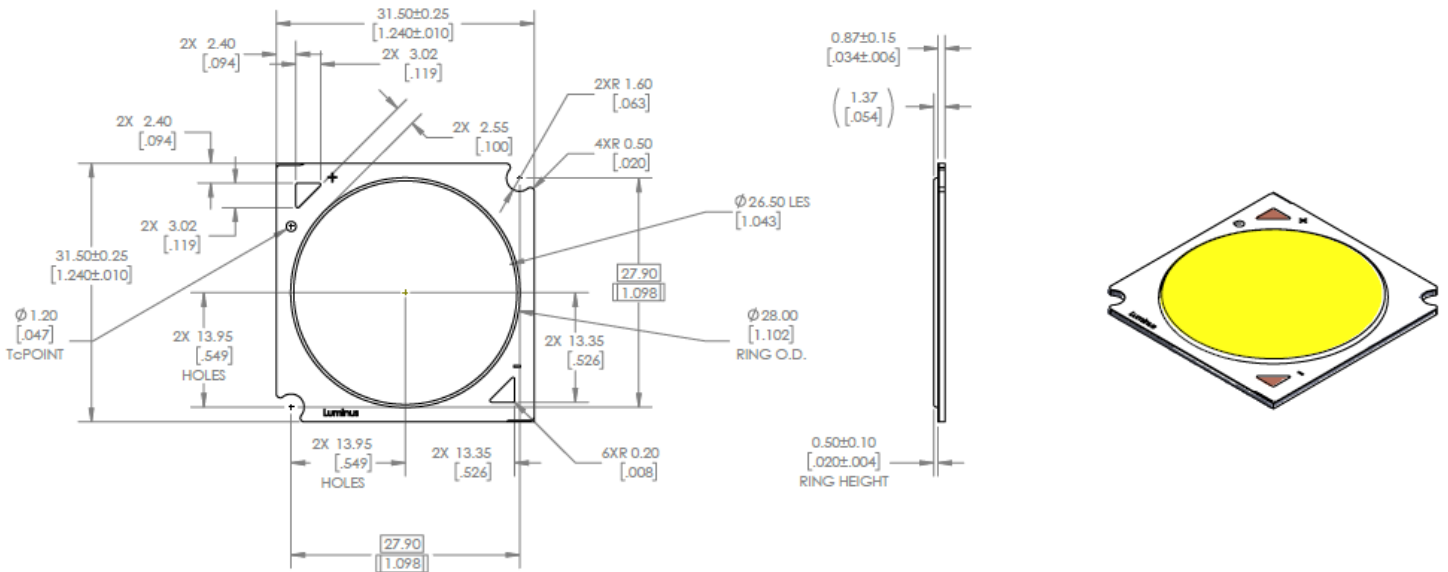

### Shipping Container (CXM-27)

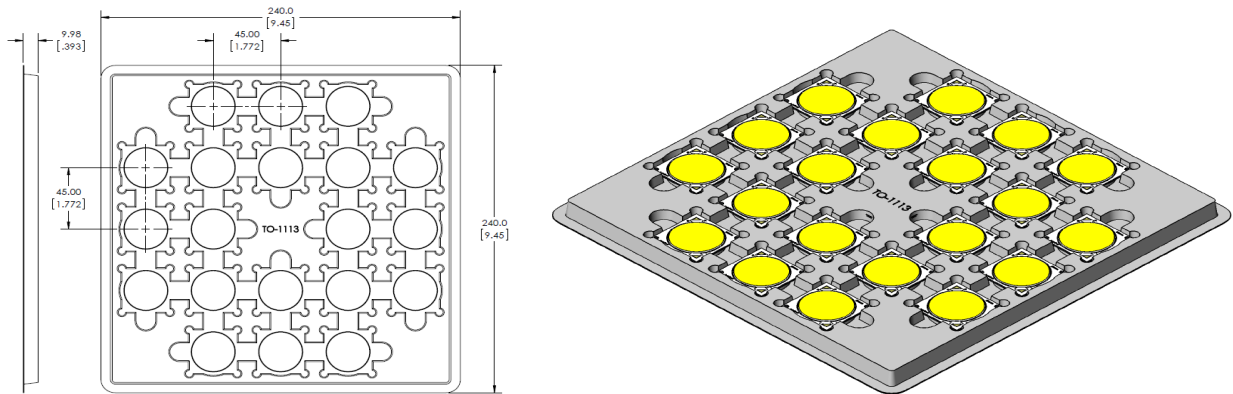

100 pcs per box  
Each bag is boxed for easier storage/ stacking

Trays are sealed in an anti-static bag

20 pcs per tray  
5 trays are stacked together with separate cover

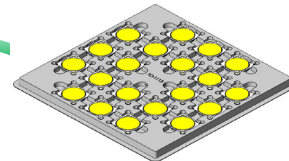

Luminus Label Model:

	<b>Luminus Devices Inc</b>	<b>RoHS Compliant</b>
XXXXXX-XX-XX (Manufacturer Part Number & Bin Kits)	Rev XX	
Bar code	Bar code	
XXX-XX-XX-XX-XX-XXXX-XX-X (Customer Part Number)	Qty: XX	
XXXXXXXXXXXXXXXX (Box ID)	Bar code	

## Handling Notes for Luminus COBs

Luminus products are designed for robust performance in general lighting application. However, care must be taken when handling and assembling the LEDs into their fixtures. To avoid damaging Luminus COBs please follow these guide lines.

The following is an overview of the application notes detailing some of the practices to follow when working with these devices. More detailed information is available on the Luminus web site at [www.luminus.com](http://www.luminus.com).

### General Handling

Devices are made to be lifted or carried with tweezers on two adjacent corners opposite the contact pads. At no time should the devices be handled by or should anything come in contact with the light emitting surface (LES) area. This area includes the yellow colored circular area and the ring surrounding it. There are electrical connections under the LES which if damaged will cause the device to fail.

In addition, the ring frame itself should not be used for moving, lifting or carrying the device. Also do not attach any optics or mechanical holders to the ring as it is not capable to handle the mechanical stress.

### Static Electricity

Luminus COBs are electronic devices which can be damaged by electrostatic discharge (ESD). Please use appropriate measures to assure the devices do not experience ESD during their handling and or storage. ESD protection guidelines should be used at all times when working with Luminus COBs.

**Storage:** Luminus products are delivered in ESD shielded bags and should be stored in these bags until used.

**Assembly:** Individuals handling Luminus COBs during assembly should be trained in ESD protection practices. Assemblers should maintain constant conductive contact with a path to ground by means of a wrist strap, ankle straps, mat or other ESD protection system.

**Transporting:** When transporting the devices from one assembly area to another, ESD shielded carts and carriers should be used.

### Electrical Contact

Luminus COBs are designed with contact pads on their top surface. These pads are clearly marked with + and – polarity. Wires can be soldered to the contact pads for electrical connections or other solderless connector products are available.

If wires are being soldered to the COB product, we recommend attaching these wires prior to mounting the devices to a heat sink. Please contact Luminus for specific recommendations on how to solder wires if not familiar with the standard practice. Luminus can also offer design recommendations for jigs to allow easily soldering multiple products in rapid succession.

### Chemical Compatibility

The resin material used to form the LES can get hydrocarbons from the surrounding environment. As a result, certain chemical compounds are not recommended for use with the Luminus products. Use of these compounds can cause damage to the light output of the device and may permanently damage the device. Please refer to [www.luminus.com](http://www.luminus.com) for a list of the compounds not recommended for use with the Luminus COB products.

### Thermal Interface Material (TIM)

Proper thermal management is critical for successful operation of any LED system. Excess operating temperature can reduce the light output of the device. And excessive heating can cause permanent damage to the device. Proper TIM material is a crucial component for effective heat transfer away from the LED during normal operation. Please refer to [www.luminus.com](http://www.luminus.com) for specific recommendations for TIM solutions.



Компания «ЭлектроПласт» предлагает заключение долгосрочных отношений при поставках импортных электронных компонентов на взаимовыгодных условиях!

Наши преимущества:

- Оперативные поставки широкого спектра электронных компонентов отечественного и импортного производства напрямую от производителей и с крупнейших мировых складов;
- Поставка более 17-ти миллионов наименований электронных компонентов;
- Поставка сложных, дефицитных, либо снятых с производства позиций;
- Оперативные сроки поставки под заказ (от 5 рабочих дней);
- Экспресс доставка в любую точку России;
- Техническая поддержка проекта, помощь в подборе аналогов, поставка прототипов;
- Система менеджмента качества сертифицирована по Международному стандарту ISO 9001;
- Лицензия ФСБ на осуществление работ с использованием сведений, составляющих государственную тайну;
- Поставка специализированных компонентов (Xilinx, Altera, Analog Devices, Intersil, Interpoint, Microsemi, Aeroflex, Peregrine, Syfer, Eurofarad, Texas Instrument, Miteq, Cobham, E2V, MA-COM, Hittite, Mini-Circuits, General Dynamics и др.);

Помимо этого, одним из направлений компании «ЭлектроПласт» является направление «Источники питания». Мы предлагаем Вам помощь Конструкторского отдела:

- Подбор оптимального решения, техническое обоснование при выборе компонента;
- Подбор аналогов;
- Консультации по применению компонента;
- Поставка образцов и прототипов;
- Техническая поддержка проекта;
- Защита от снятия компонента с производства.



#### Как с нами связаться

**Телефон:** 8 (812) 309 58 32 (многоканальный)

**Факс:** 8 (812) 320-02-42

**Электронная почта:** [org@eplast1.ru](mailto:org@eplast1.ru)

**Адрес:** 198099, г. Санкт-Петербург, ул. Калинина, дом 2, корпус 4, литера А.