

LOC	DIST	REVISIONS					
		P	LTN	DESCRIPTION	DATE	DWN	APVD
ES	00	G9		ADD NEW DASH NUMBER 2-9	04MAY2012	CZ	SZ
		H2		REV PER ECR-12-020199	22NOV2012	CZ	SZ
		H4		ADDED THE NEW DASH NUMBER -33	28DEC2012	ML	SZ

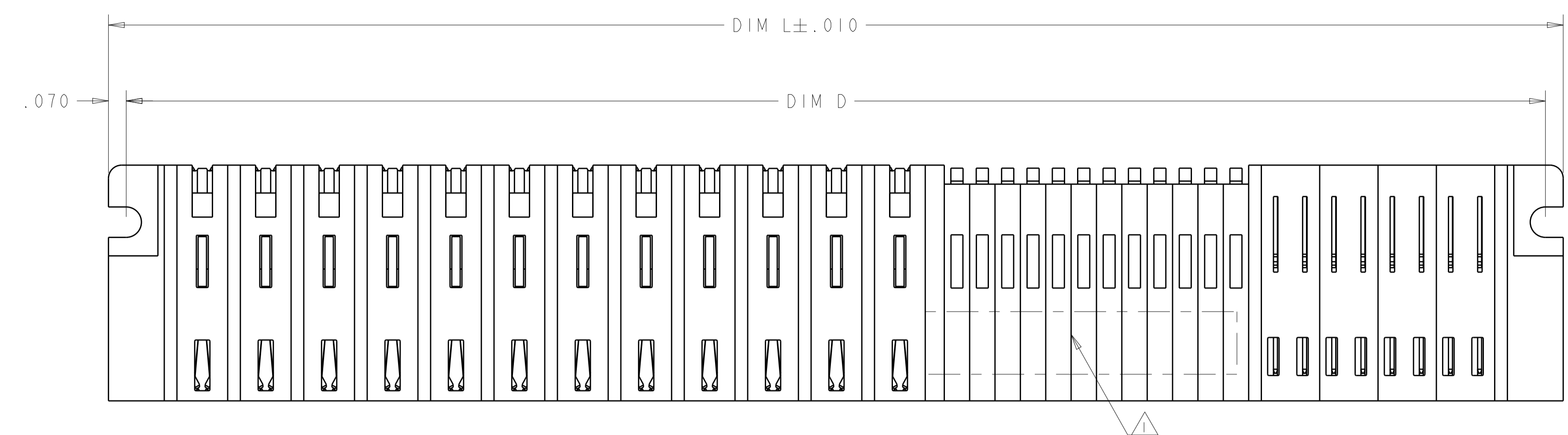

- 1 "AMP", PART NUMBER, AND DATECODE TO BE MARKED IN AREA SHOWN. PARTS UNDER 2.00 LONG MAY BE MARKED ON BOTH SIDES.
- 2 MATERIAL:
HOUSING - GLASS FILLED HIGH TEMP THERMO PLASTIC, BLACK, UL94 V-0
SIGNAL CONTACT - COPPER ALLOY
POWER CONTACT - HIGH CONDUCTIVITY COPPER ALLOY.
- 3 CONTACT PLATING - NOBLE METAL PLATING ON CONTACT FUNCTIONAL AREA OF POWER AND SIGNAL CONTACTS
- 4 MECHANICAL CONNECTOR KEEP OUT ZONE.
- 5 DATUM AND BASIC DIMENSIONS ESTABLISHED BY CUSTOMER.
- 6 PCB - HOLE DIAMETERS ARE FINISHED HOLE SIZE.
- 7 PCB - .0453±.0010 DRILLED HOLES PLATED WITH .0003 MIN Sn OVER .001 TO .003 Cu PLATING TO ACHIEVE A .040 DIA HOLE.
- 8 TO GENERAL POWER CONTACT (WITHOUT LP POWER CONTACT), VARIABLE DIMENSIONS PLEASE SEE SHEET 2.
- 9 PLEASE REFER TO PAGE 5 FOR DETAIL DIMENSIONS.
- 10 PLEASE REFER TO PAGE 7 FOR SPECIAL DIMENSIONS.
- 11 FOR LP/S/P CONFIGURATION, OR SPECIAL DIMENSIONS FOR PART 2-6450840-1, PLEASE REFER TO SHEET 2.

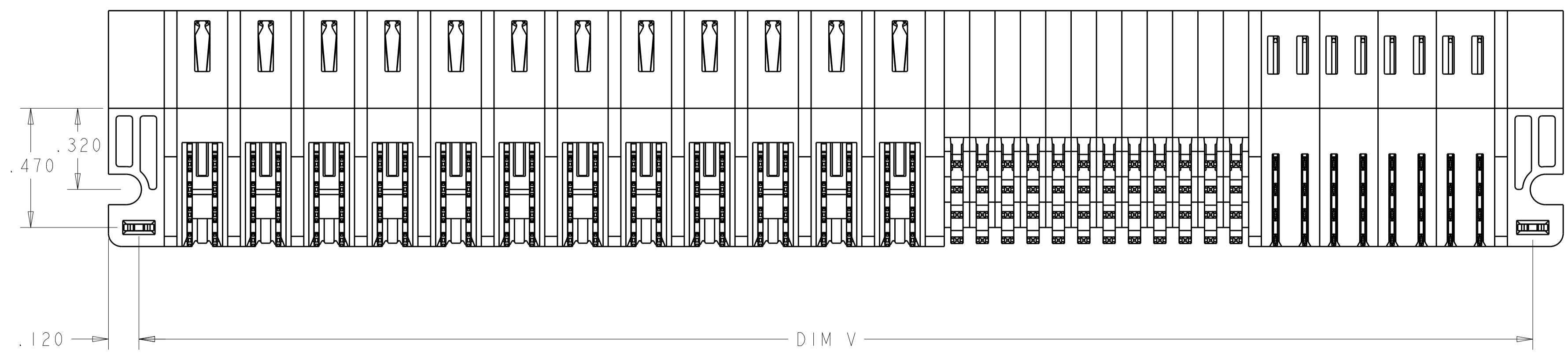
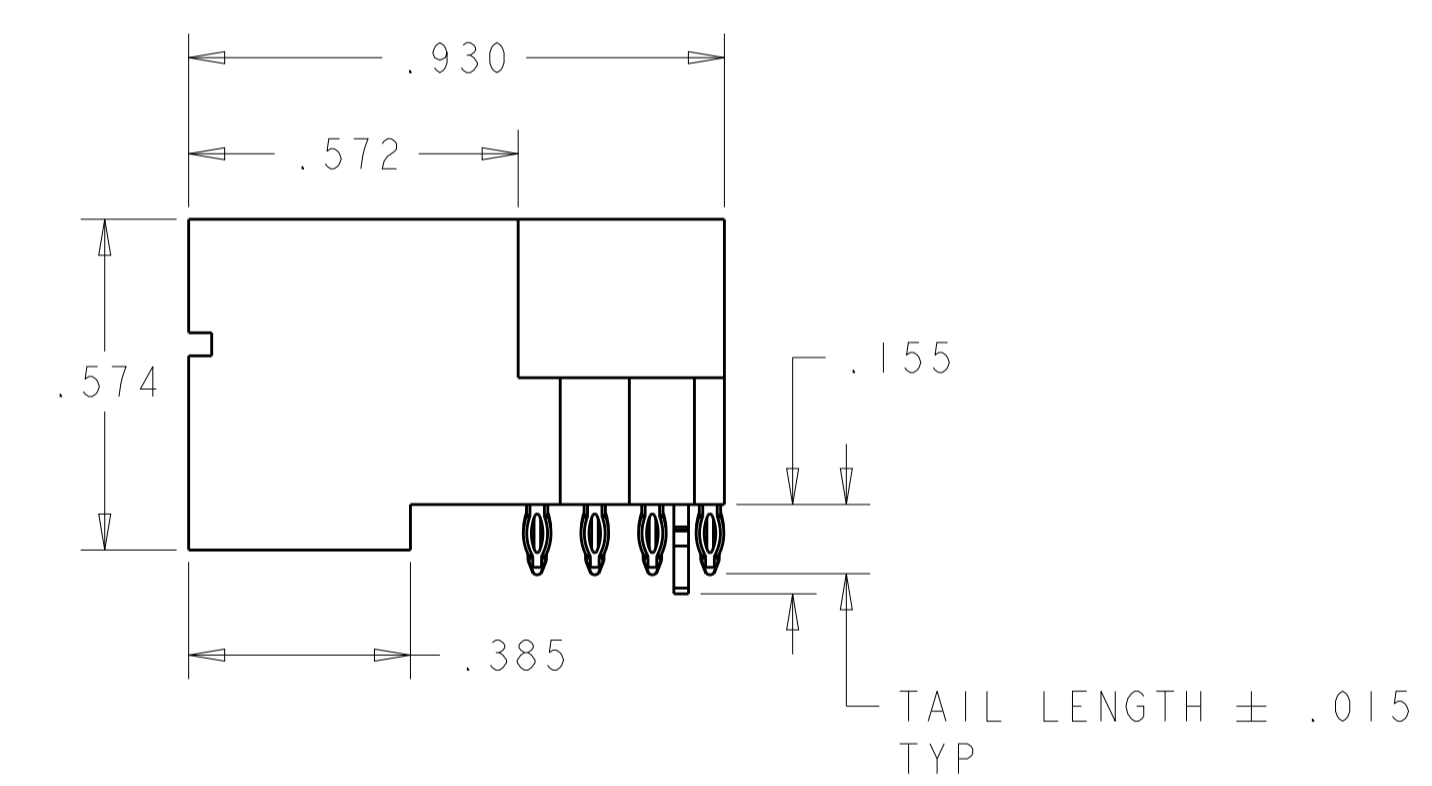
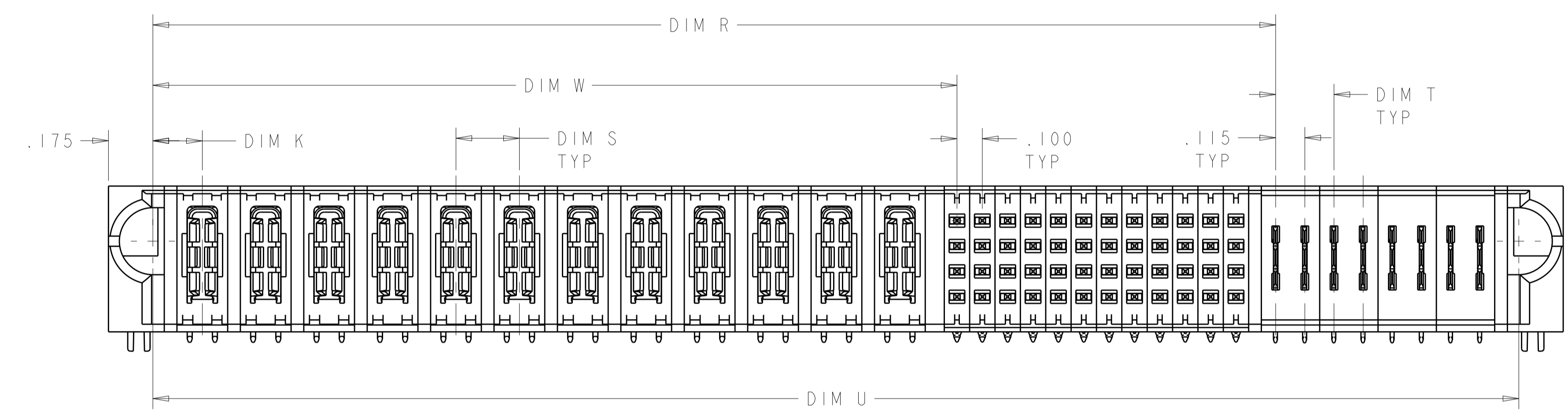

THIS DRAWING IS A CONTROLLED DOCUMENT.		DWN ALEX SHOAL CHK Sunny Zhao	14DEC2007 20DEC2007		NAME RIGHT ANGLE HEADER W/ LP CONTACT AND SHORT END MODULES MULTI-BEAM XLE	
DIMENSIONS: INCHES		TOLERANCES UNLESS OTHERWISE SPECIFIED:			APVD Sunny Zhao 20DEC2007	PRODUCT SPEC 108-2292
		0 PLC ±	1 PLC ±.01	SIZE A100779		CAGE CODE 6450840
MATERIAL : 2		2 PLC ±.01	3 PLC ±.005	RESTRICTED TO		
FINISH : 3		4 PLC ±.0050	ANGLES ±.7°	WEIGHT		
		Customer Drawing		SCALE 4:1		SHEET 1 OF 16
				REV H4		

THIS DRAWING IS UNPUBLISHED. RELEASED FOR PUBLICATION 20
 © COPYRIGHT 20 BY TE CONNECTIVITY ALL RIGHTS RESERVED.

LOC	DIST	REVISIONS					
		P	LTN	DESCRIPTION	DATE	DWN	APVD
ES	00	-	-	SEE SHEET 1	-	-	-

H3	.250	2.315	1.535	.860	2.205	.230	2.415	2.555	.1275	6LP + 24S + 3P	3-6450840-3
H2	-	1.135	.8075	.375	1.025	-	1.235	1.375	.1025	2LP + 16S + 2LP	3-6450840-1
	.250	2.300	1.520	.845	2.190	.250	2.400	2.540	.170	3P + 24S + 3P	2-6450840-9
	.250	3.800	2.270	1.595	3.690	.250	3.900	4.040	.170	6P + 24S + 6P	2-6450840-7
	.250	4.400	2.370	2.095	4.290	.250	4.500	4.640	.170	8P + 8S + 8P	1-6450840-6
	.250	1.700	1.145	.645	1.590	.250	1.800	1.940	.195	2P + 16S + 2P	2-6450840-5
	.250	6.000	3.970	2.095	5.890	.250	6.100	6.240	.170	8P + 72S + 8P	2-6450840-3
	.250	2.500	1.470	1.095	2.390	.250	2.600	2.740	.170	4P + 12S + 4P	2-6450840-2
	.230	5.585	1.5025	.645	5.475	.250	5.685	5.825	.170	2P + 32S + 4LP + 14P	2-6450840-1
	.250	3.520	2.990	2.265	3.410	.230	3.620	3.760	.1525	18LP + 24S + 2P	2-6450840-0
	-	1.300	1.020	.345	1.190	-	1.400	1.540	.170	1P + 24S + 1P	1-6450840-5
	.200	3.300	2.020	1.345	3.190	.200	3.400	3.540	.170	6HDP + 24S + 6HDP	1-6450840-2
	.200	2.400	1.520	.945	2.290	.200	2.500	2.640	.170	4HDP + 20S + 4HDP	1-6450840-1
	.250	2.400	1.370	1.095	2.290	.250	2.500	2.640	.170	4P + 8S + 4P	1-6450840-0
	.200	2.100	1.220	.945	1.990	.200	2.200	2.340	.170	4HDP + 8S + 4HDP	6450840-9
	-	-	-	-	-	-	-	-	-	4P+16S+24S+2HDP	6450840-8
	-	1.300	1.020	.345	1.190	-	1.400	1.540	.170	1P + 24S + 1P	6450840-7
	-	2.480	2.1525	1.345	2.370	.250	2.580	2.720	.170	5P + 32S + 2LP	6450840-6
	.250	3.400	2.120	1.395	3.290	.250	3.500	3.640	.170	5P + 24S + 5P	6450840-5
	.200	5.150	2.670	1.345	5.040	.300	5.250	5.390	.195	4ACP + 48S + 12HDP	6450840-4
	.230	5.495	4.4275	3.170	5.385	.250	5.595	5.735	.195	12P + 48S + 8LP	6450840-3
	-	2.315	-	-	2.205	-	2.415	2.555	.170	3P+ 1LP + 24S + 3HDP	6450840-2
	DIM T	DIM V	DIM R	DIM W	DIM U	DIM S	DIM D	DIM L	DIM K	DESCRIPTION	PART NUMBER

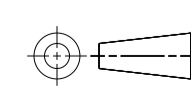
THIS DRAWING IS A CONTROLLED DOCUMENT.		DWN ALEX SHOAL CHK Sunny Zhao	14DEC2007 20DEC2007	 TE Connectivity
DIMENSIONS: INCHES		TOLERANCES UNLESS OTHERWISE SPECIFIED: 0 PLC ±. 2 PLC ±.01 3 PLC ±.005 4 PLC ±.0050 ANGLES ±.0°	APVD Sunny Zhao Z0DEC2007	
		MATERIAL	PRODUCT SPEC 108-2292	RESTRICTED TO
FINISH		WEIGHT	APPLICATION SPEC 114-13251	SIZE A100779
Customer Drawing		SCALE 1:1	DRAWING NO 6450840	SHEET 2 OF 16
				REV H4

LOC		DIST		REVISIONS			
ES	00	P	LTH	DESCRIPTION	DATE	DMN	APVD
		-		SEE SHEET 1			

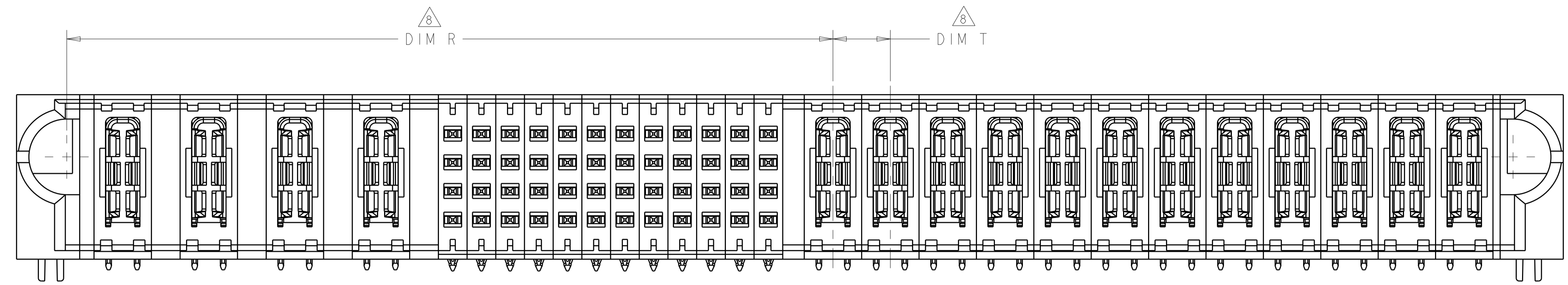

FOR P/S/P CONFIGURATION
 UNSPECIFIED DIM REFER TO SHEET 1
 SCALE 4:1

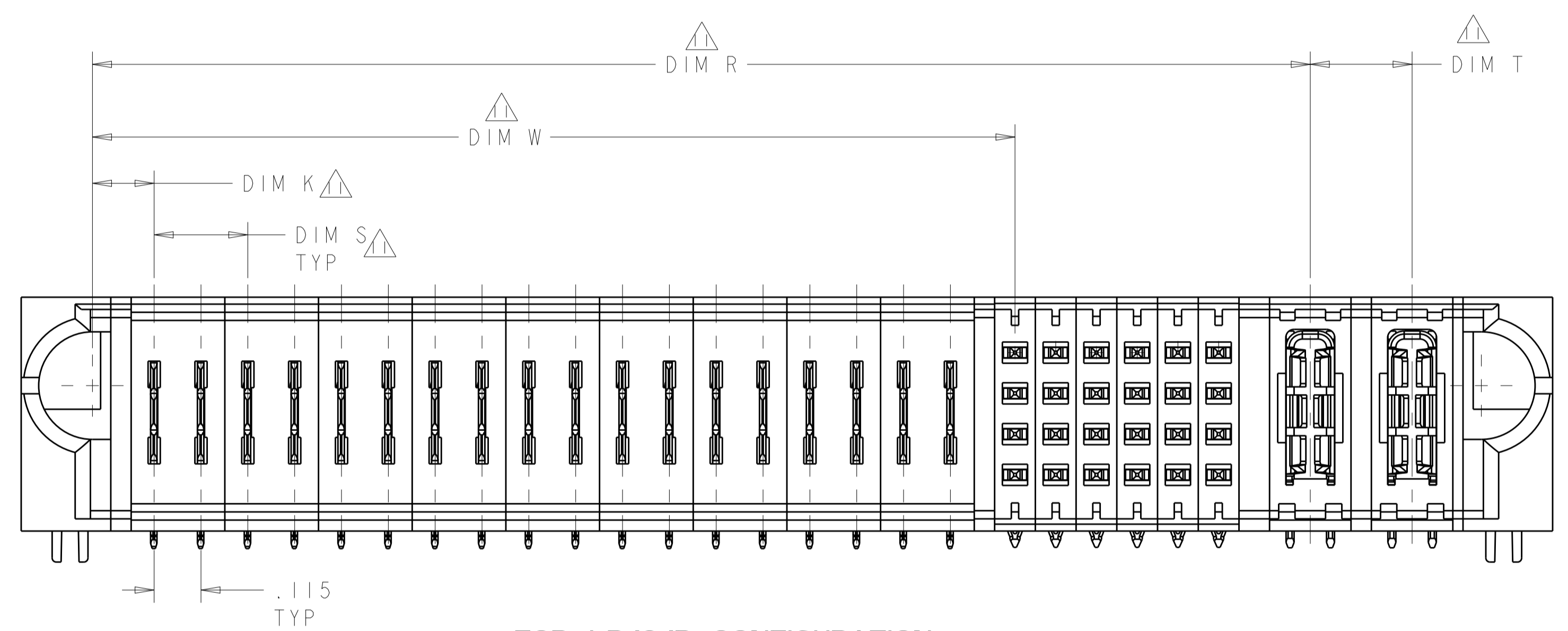

FOR LP/S/P CONFIGURATION
 UNSPECIFIED DIM REFER TO SHEET 1

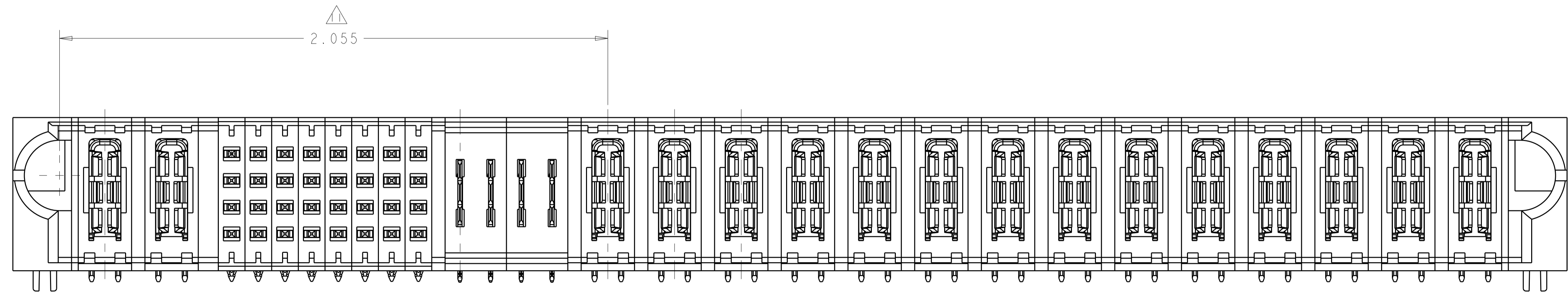

FOR PART 2-6450840-1 ONLY

THIS DRAWING IS A CONTROLLED DOCUMENT.		DMN: ALEX SHOAL 14DEC2007	 TE Connectivity NAME: RIGHT ANGLE HEADER W/ LP CONTACT AND SHORT END MODULES MULTI-BEAM XLE
DIMENSIONS: INCHES		CHK: Sunny Zhao 20DEC2007	
TOLERANCES UNLESS OTHERWISE SPECIFIED:		APVD: Sunny Zhao 20DEC2007	
0 PLC ±. 1 PLC ±.01 2 PLC ±.01 3 PLC ±.005 4 PLC ±.0050 ANGLES ±.0°		PRODUCT SPEC: 108-2292 APPLICATION SPEC: 114-13251 WEIGHT: - FINISH: -	
MATERIAL: -		SIZE: A100779	CAGE CODE: C=6450840 CUSTOMER DRAWING: - SCALE: 1:1 SHEET 3 OF 16 REV: H4

LOC	DIST	REVISIONS					
		P	LTN	DESCRIPTION	DATE	DMN	APVD
ES	00	-	-	SEE SHEET 1	-	-	-

PART NUMBER	ROWS	POWER												SIGNAL												POWER											
		P1	P2	P3	P4	P5	P6	P7	P8	P9	P10	P11	P12	1	2	3	4	5	6	7	8	9	10	11	12	LP1	LP2	LP3	LP4	LP5	LP6	LP7	LP8				
6450840-3	D													Z5	Z5	Z5	Z5	Z5	Z5	Z5	Z5	Z5	Z5	Z5													
	C													Y5	Y5	Y5	Y5	Y5	Y5	Y5	Y5	Y5	Y5	Y5													
	B	TT	TT	TT	TT	TT	TT	TT	TT	TT	TT	TT	TT	R5	R5	R5	R5	R5	R5	R5	R5	R5	R5	R5													
	A	HD												O5	O5	O5	O5	O5	O5	O5	O5	O5	O5	O5													
12P + 48S + 8LP																																					

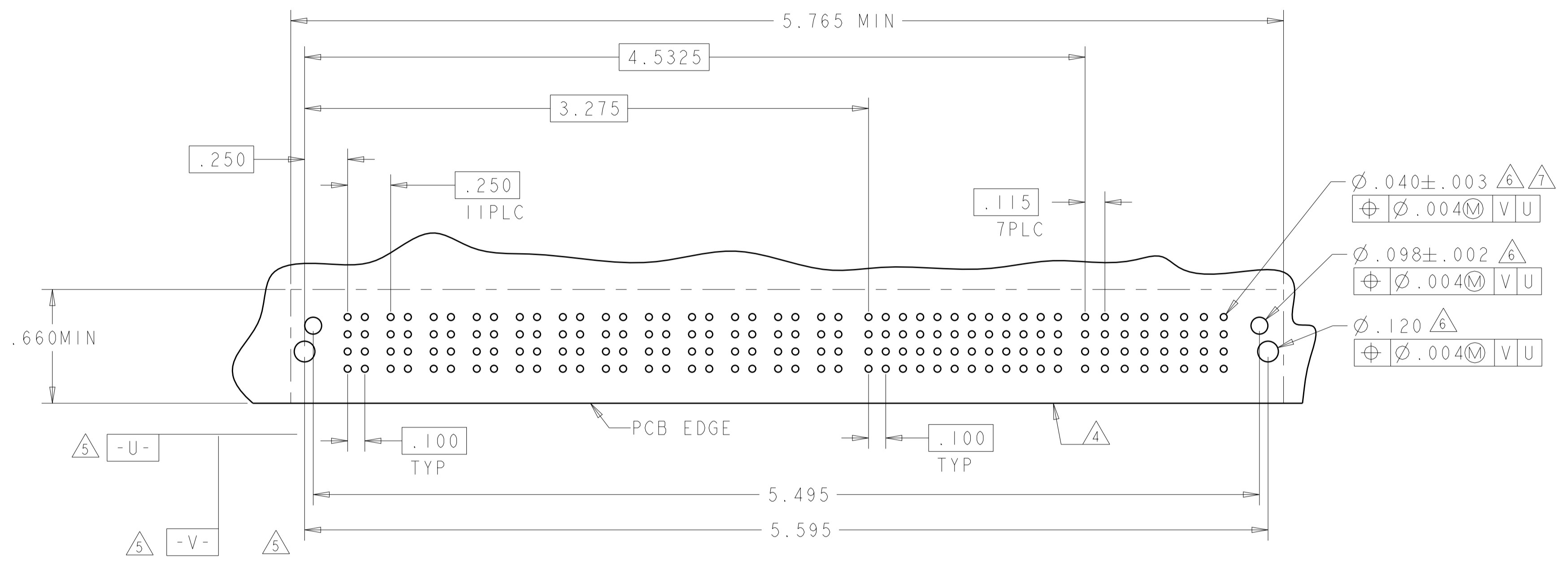

PART NUMBER	ROWS	POWER				SIGNAL												POWER																				
		P1	P2	P3	P4	1	2	3	4	5	6	7	8	9	10	11	12	P5	P6	P7	P8	P9	P10	P11	P12	P13	P14	P15	P16									
6450840-4	D					Z5	Z5	Z5	Z5	Z5	Z5	Z5	Z5	Z5	Z5	Z5	Z5																					
	C					Y5	Y5	Y5	Y5	Y5	Y5	Y5	Y5	Y5	Y5	Y5	Y5																					
	B	TT	TT	TT	TT	R5	R5	R5	R5	R5	R5	R5	R5	R5	R5	R5	R5																					
	A	HD				O5	O5	O5	O5	O5	O5	O5	O5	O5	O5	O5	O5																					
4ACP + 48S + 12HDP																																						

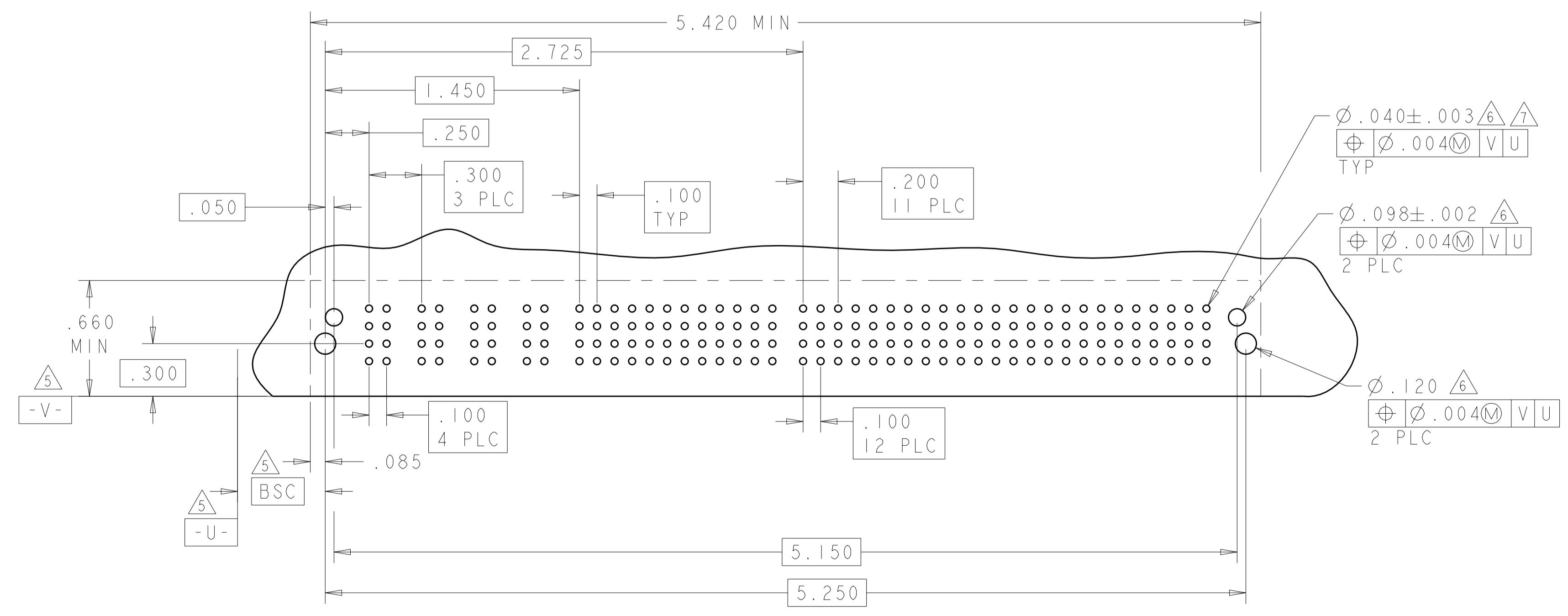

DESCRIPTION	IDENTIFIER
HOLD DOWN	HD
.120 SIGNAL PRESS FIT CON, ROW A,MLBF	O1
.120 SIGNAL PRESS FIT CON, ROW B,MLBF	R1
.120 SIGNAL PRESS FIT CON, ROW C,MLBF	Y1
.120 SIGNAL PRESS FIT CON, ROW D,MLBF	Z1
.120 SIGNAL PRESS FIT CON, ROW A,STD	O5
.120 SIGNAL PRESS FIT CON, ROW B,STD	R5
.120 SIGNAL PRESS FIT CON, ROW C,STD	Y5
.120 SIGNAL PRESS FIT CON, ROW D,STD	Z5
.120 PRESS FIT LOWER POWER CON	LT
.120 PRESS FIT POWER CON	TT

THIS DRAWING IS A CONTROLLED DOCUMENT. DWG: ALEX_SHOAL 14DEC2007
 CHK: Sunny Zhao 20DEC2007
 APVD: Sunny Zhao 20DEC2007

TE Connectivity

NAME: RIGHT ANGLE HEADER W/ LP CONTACT AND SHORT END MODULES MULTI-BEAM XLE

PRODUCT SPEC: 108-2292
 APPLICATION SPEC: 114-13251
 WEIGHT: -
 SCALE: 1:1 SHEET 4 OF 16 REV: H4

Customer Drawing

LOC	DIST	REV	DATE	APPD
ES	00			

PART NUMBER	ROWS	POWER	SIGNAL						POWER		
			P1	1	2	3	4	5		6	P2
6450840-7	D C B A	TT	HD	Z5	Z5	Z5	Z5	Z5	Z5	TT	HD
				Y5	Y5	Y5	Y5	Y5	Y5		
				R5	R5	R5	R1	R5	R5		
				O5	O5	O5	O5	O5	O5		
IP + 24S + IP											

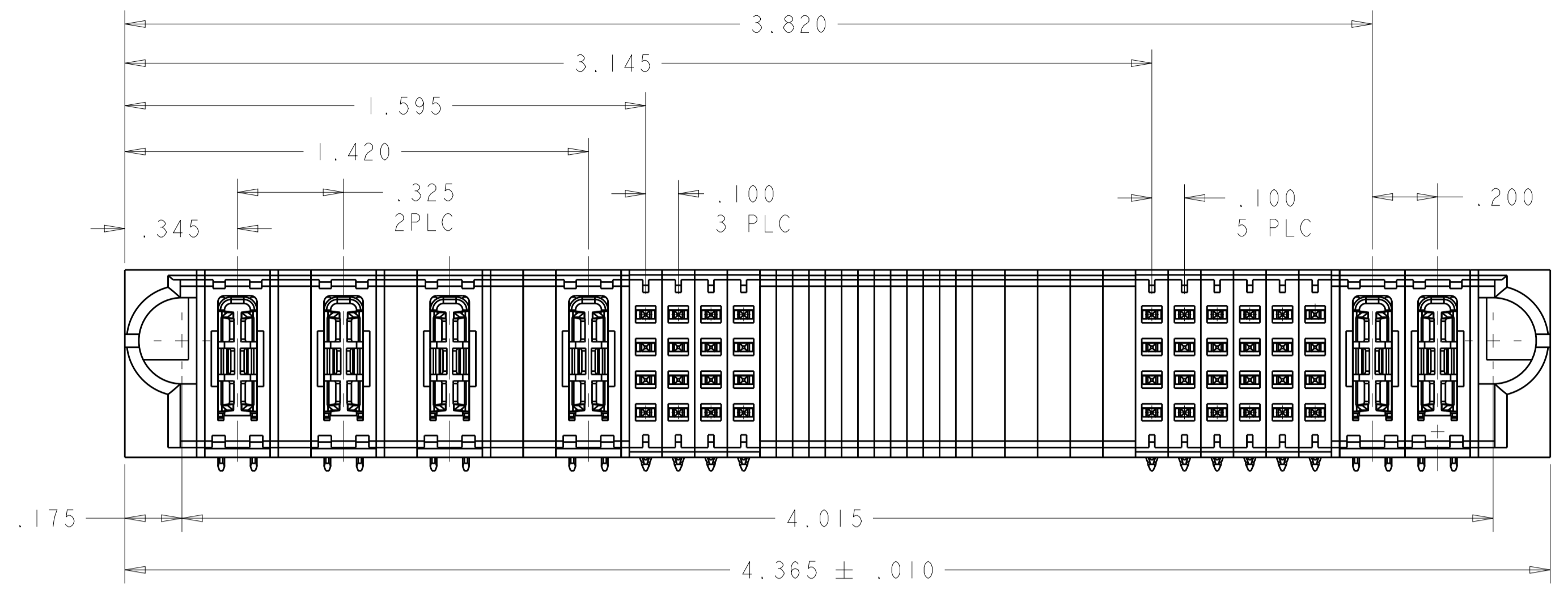

PART NUMBER: 6450840-8

PART NUMBER	ROWS	POWER	SIGNAL				BLANK	SIGNAL				POWER	
			P1	P2	P3	P4		5	6	7	8		9
6450840-8	D C B A	TT	TT	TT	TT	TT	BLANK	Z5	Z5	Z5	Z5	TT	TT
								Y5	Y5	Y5	Y5		
								R5	R5	R5	R5		
								O5	O5	O5	O5		
4P + 16S + 24S + 2HDP													

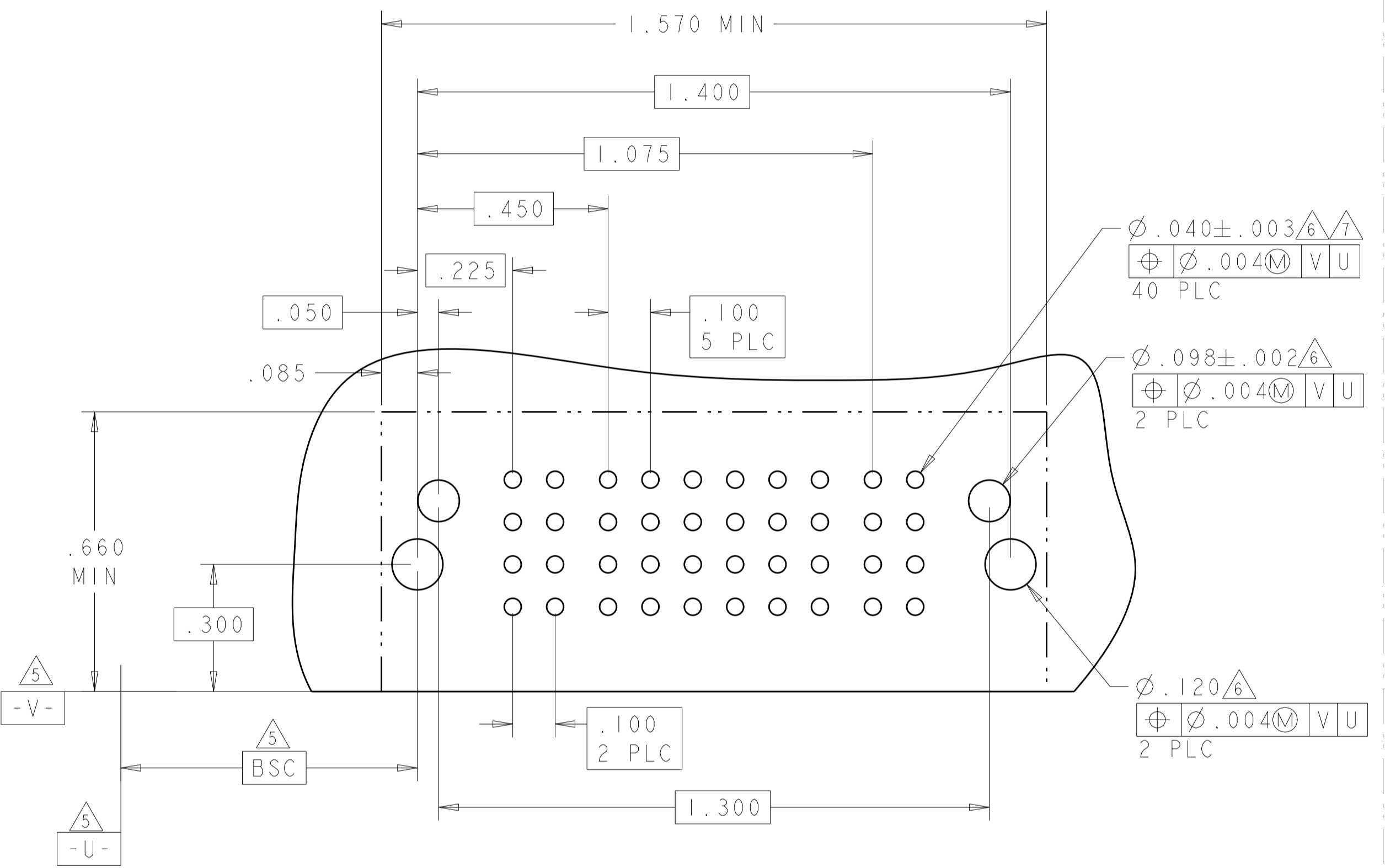

PART NUMBER	ROWS	POWER	SIGNAL						POWER		
			P1	1	2	3	4	5		6	P2
1-6450840-5	D C B A	TT	HD	Z5	Z5	Z5	Z5	Z5	Z5	TT	HD
				Y5	Y5	Y5	Y5	Y5	Y5		
				R5	R5	R5	R5	R5	R5		
				O5	O5	O1	O5	O5	O5		
IP + 24S + IP											

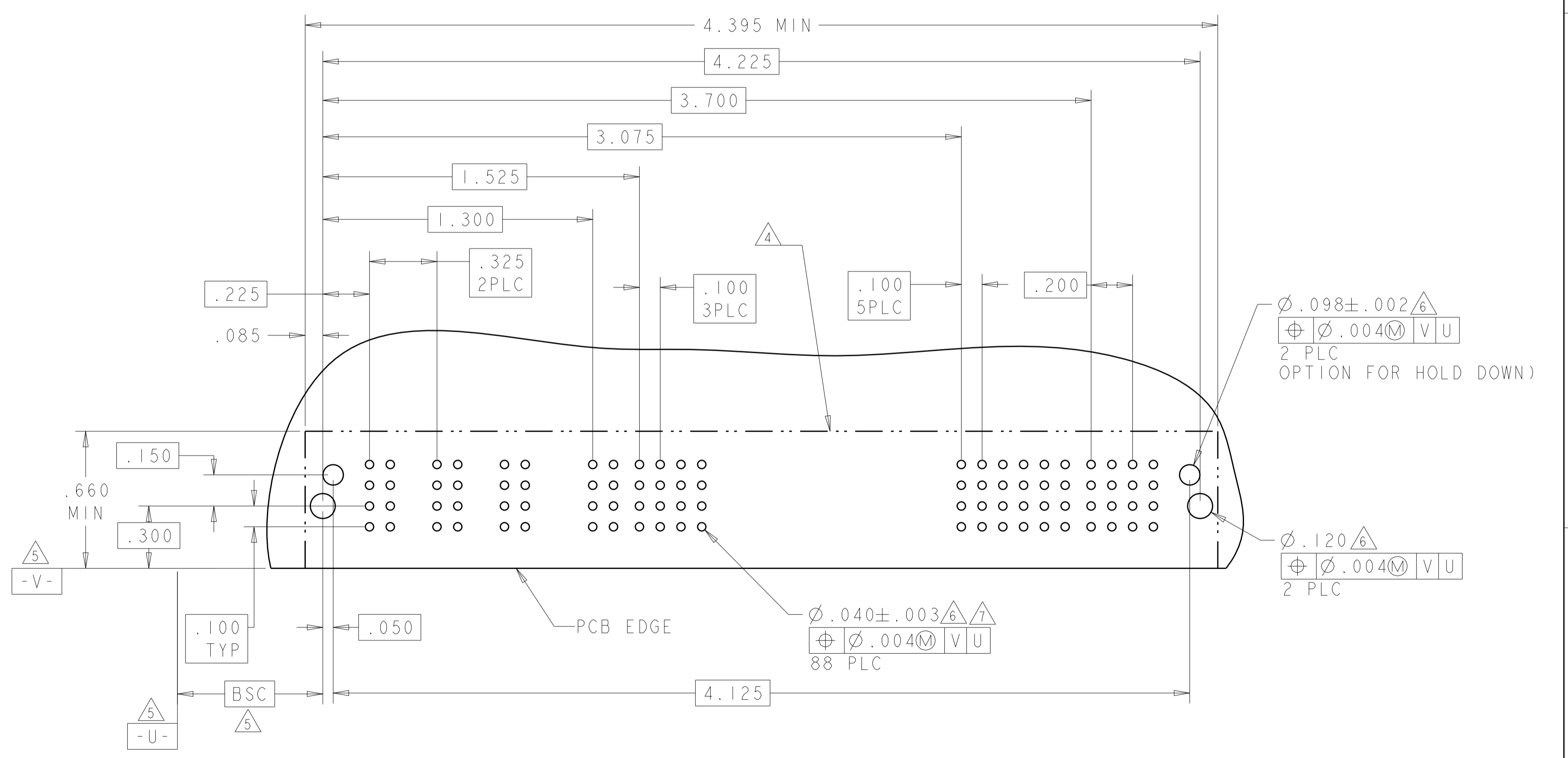

LAYOUT OF 1-6450840-5 IS SAME AS 6450840-7.

THIS DRAWING IS A CONTROLLED DOCUMENT.		OWN: ALEX SHOAL 14DEC2007	TE Connectivity
DIMENSIONS: INCHES		CHK: Sunny Zhao 20DEC2007	
TOLERANCES UNLESS OTHERWISE SPECIFIED:		APVD: Sunny Zhao 20DEC2007	NAME: RIGHT ANGLE HEADER W/ LP CONTACT AND SHORT END MODULES MULTI-BEAM XLE
0 PLC ±.01		PRODUCT SPEC: 108-2292	SIZE: A1
1 PLC ±.01		APPLICATION SPEC: 114-13251	CAGE CODE: C=6450840
2 PLC ±.01		WEIGHT: -	RESTRICTED TO: -
3 PLC ±.01		FINISH: -	SCALE: 1:1
4 PLC ±.005		CUSTOMER DRAWING	SHEET 6 OF 16
ANGLES ±.0050			REV: H4

LOC	DIST	REVISIONS			
P	LTN	DESCRIPTION	DATE	OWN	APVD
ES	00	SEE SHEET 1			

PART NUMBER	ROWS	POWER				SIGNAL	POWER				
		P1	P2	P3	P4	1 2	P5	P6	P7	P8	
6450840-9	D C B A	TT	TT	TT	TT	Z5 Z5 Y5 Y5 R5 R5 O5 O5	TT	TT	TT	TT	
4HDP + 8S + 4HDP											

PART NUMBER	ROWS	POWER				SIGNAL	POWER				
		P1	P2	P3	P4	1 2	P5	P6	P7	P8	
1-6450840-0	D C B A	TT	TT	TT	TT	Z5 Z5 Y5 Y5 R5 R5 O5 O5	TT	TT	TT	TT	
4P + 8S + 4P											

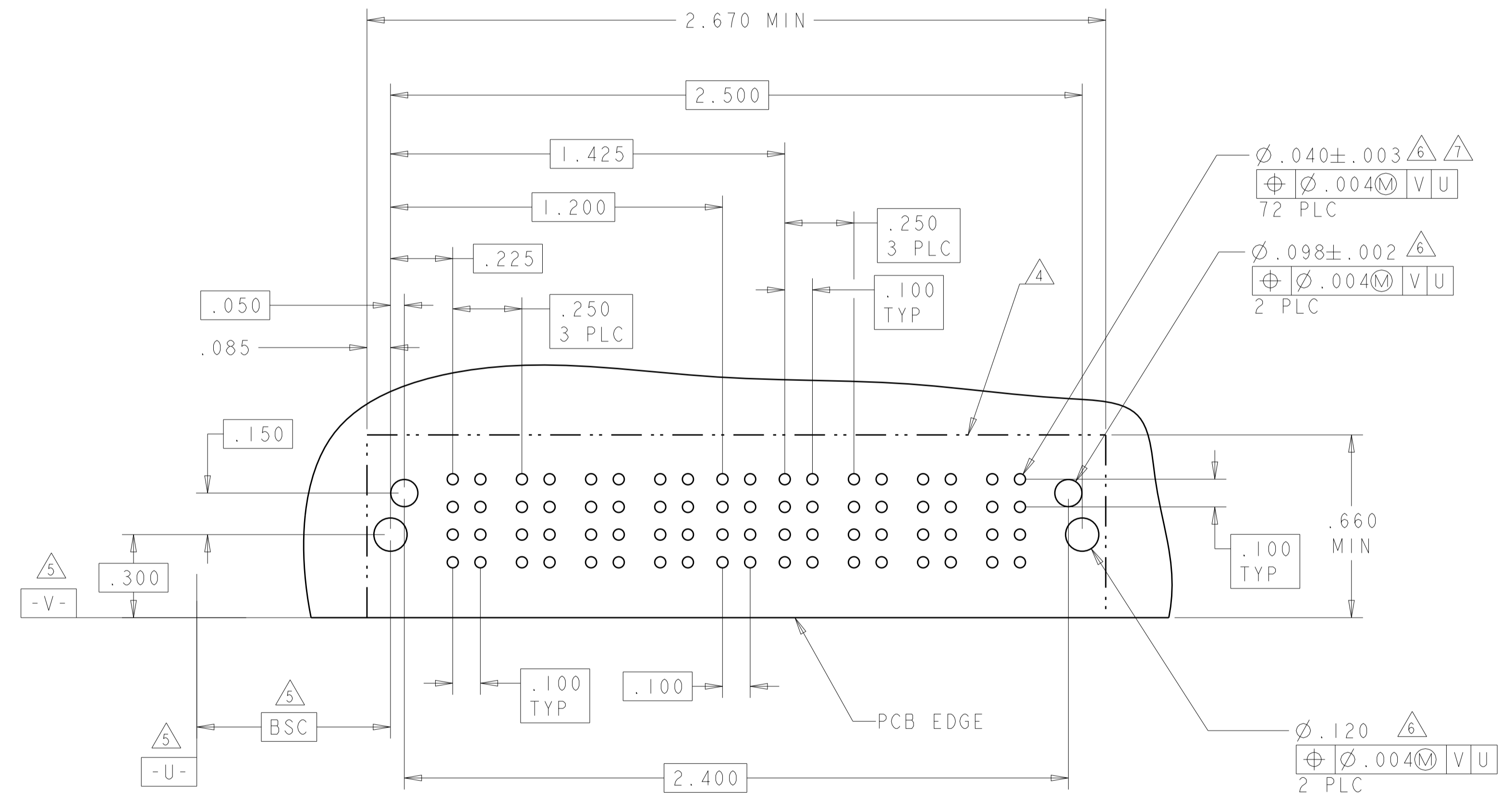
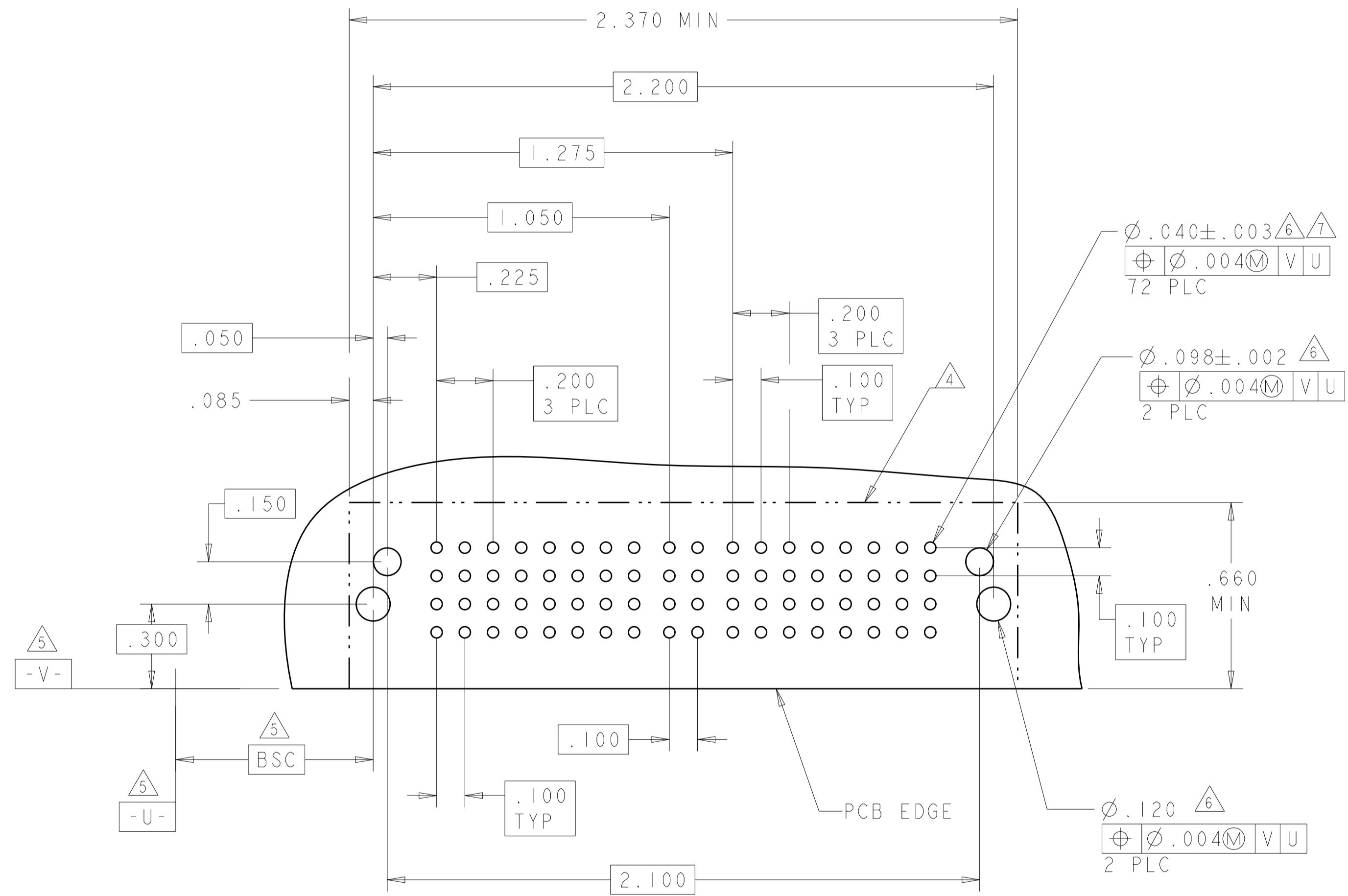

THIS DRAWING IS A CONTROLLED DOCUMENT.

DIMENSIONS: INCHES	TOLERANCES UNLESS OTHERWISE SPECIFIED: 0 PLC ±. 1 PLC ±.01 2 PLC ±.01 3 PLC ±.005 4 PLC ±.0050 ANGLES ±7°	FINISH	FINISH
-----------------------	---	--------	--------

OWN: ALEX SHOAL	DATE: 14DEC2007	TE Connectivity
CHK: Sunny Zhao	20DEC2007	
APVD: Sunny Zhao	20DEC2007	NAME: RIGHT ANGLE HEADER W/ LP CONTACT AND SHORT END MODULES MULTI-BEAM XLE
PRODUCT SPEC: 108-2292	APPLICATION SPEC: 114-13251	SIZE: A1
WEIGHT: -	Customer Drawing	SCALE: 1:1

Customer Drawing SCALE 1:1 SHEET 7 OF 16 REV H4

LOC	DIST	REVISIONS					
		P	LTN	DESCRIPTION	DATE	OWN	APVD
ES	00	-	-	SEE SHEET 1	-	-	-

PART NUMBER	ROWS	POWER						SIGNAL						POWER											
		P1	P2	P3	P4	P5	P6	1	2	3	4	5	6	P7	P8	P9	P10	P11	P12						
1-6450840-2	D	TT	TT	TT	TT	TT	TT	Z5	Z5	Z5	Z5	Z5	Z5	TT	TT	TT	TT	TT	TT						
	C							Y5	Y5	Y5	Y5	Y5	Y5												
	B							R5	R5	R5	R5	R5	R5												
	A							O5	O5	O5	O5	O5	O5												
6HDP + 24S + 6HDP																									

PART NUMBER	ROWS	LOW POWER																		SIGNAL						POWER	
		LP1	LP2	LP3	LP4	LP5	LP6	LP7	LP8	LP9	LP10	LP11	LP12	LP13	LP14	LP15	LP16	LP17	LP18	1	2	3	4	5	6	P1	P2
2-6450840-0	D	LT	LT	LT	LT	LT	LT	LT	LT	LT	LT	LT	LT	LT	LT	LT	LT	LT	LT	Z5	Z5	Z5	Z5	Z5	Z5	TT	TT
	C																			Y5	Y5	Y5	Y5	Y5	Y5		
	B																			R5	R5	R5	R5	R5	R5		
	A																			O5	O5	O5	O5	O5	O5		
18LP + 24S + 2P																											

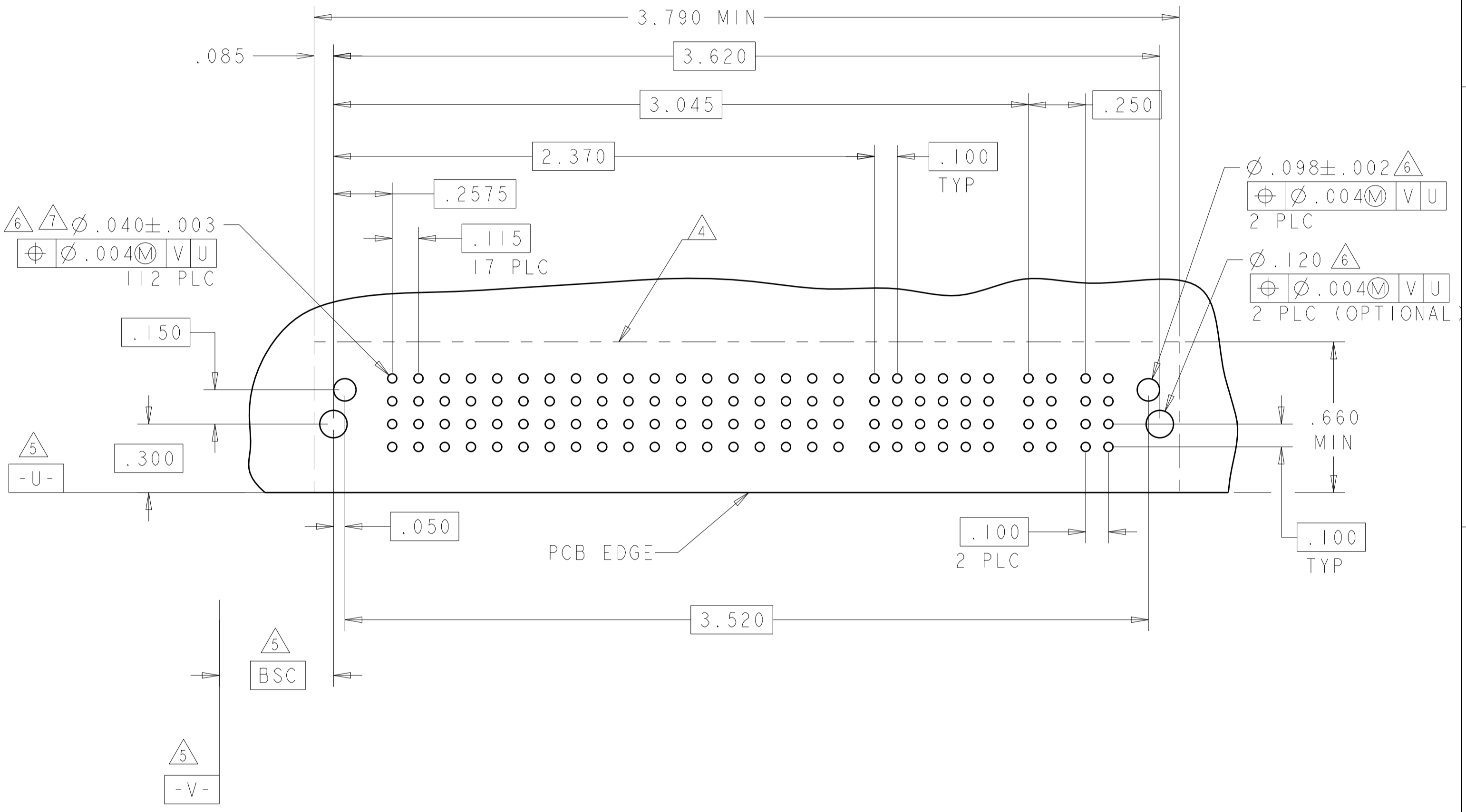
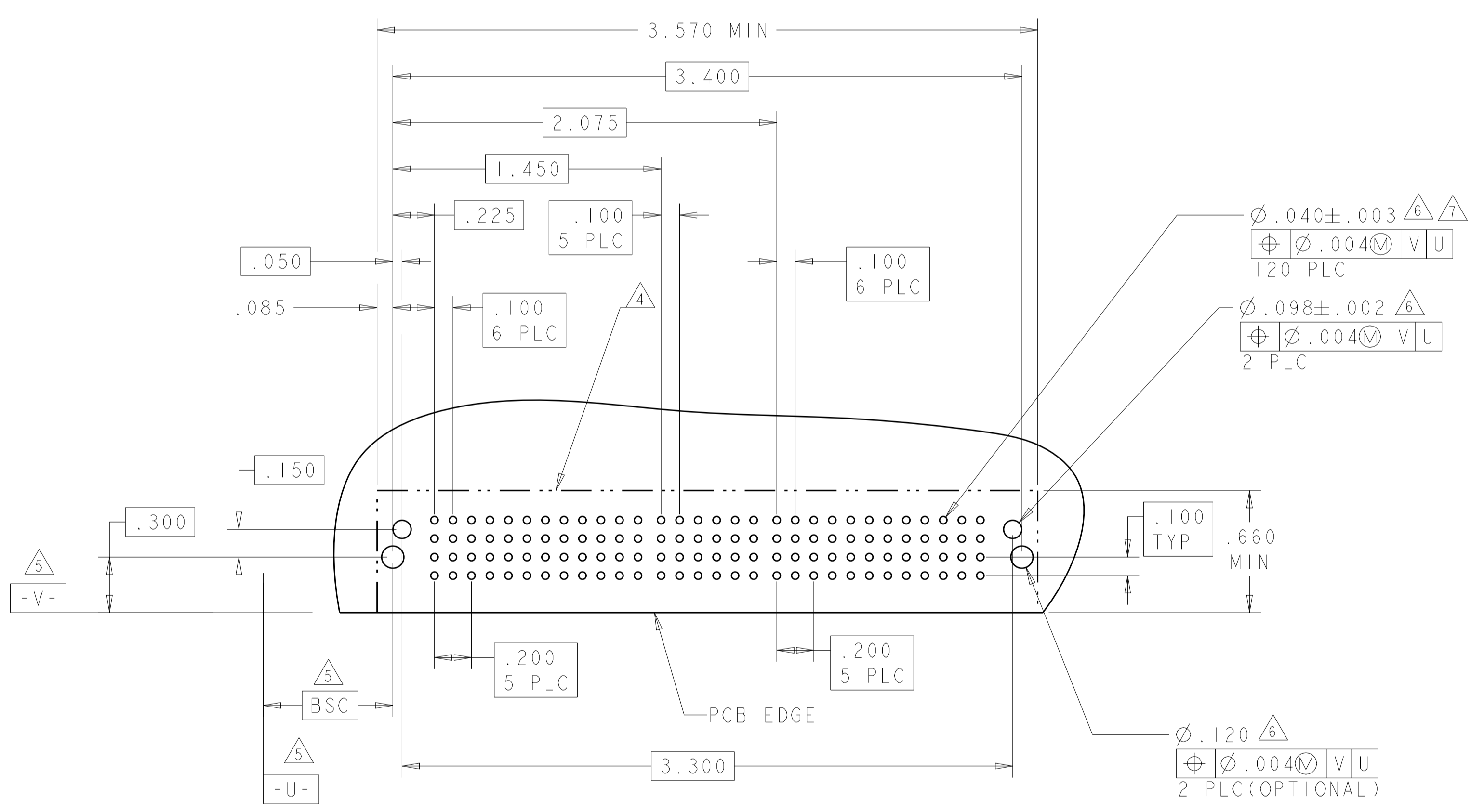

THIS DRAWING IS A CONTROLLED DOCUMENT. OWN: ALEX SHOAL 14DEC2007, CHK: Sunny Zhao 20DEC2007, APVD: Sunny Zhao 20DEC2007. DIMENSIONS: INCHES. TOLERANCES UNLESS OTHERWISE SPECIFIED: 0 PLC ±, 1 PLC ±.01, 2 PLC ±.01, 3 PLC ±.005, 4 PLC ±.0050, ANGLES ±.07°. MATERIAL: -. FINISH: -. WEIGHT: -. Customer Drawing. NAME: RIGHT ANGLE HEADER W/ LP CONTACT AND SHORT END MODULES MULTI-BEAM XLE. SIZE: 108-2292. APPLICATION SPEC: 114-13251. CAGE CODE: 100779. DRAWING NO: 6450840. SCALE: 1:1. SHEET 9 OF 16. REV: H4.

LOC	DIST	REVISIONS			
P	LTN	DESCRIPTION	DATE	DMN	APVD
ES	00	SEE SHEET 1	-	-	-

PART NUMBER	ROWS	POWER								SIGNAL		POWER							
		P1	P2	P3	P4	P5	P6	P7	P8	1	2	P9	P10	P11	P12	P13	P14	P15	P16
1-6450840-6	D C B A	TT	TT	TT	TT	TT	TT	TT	TT	Z5	Z5	TT	TT	TT	TT	TT	TT	TT	TT
										Y5	Y5								
										R5	R5								
8P + 8S + 8P																			

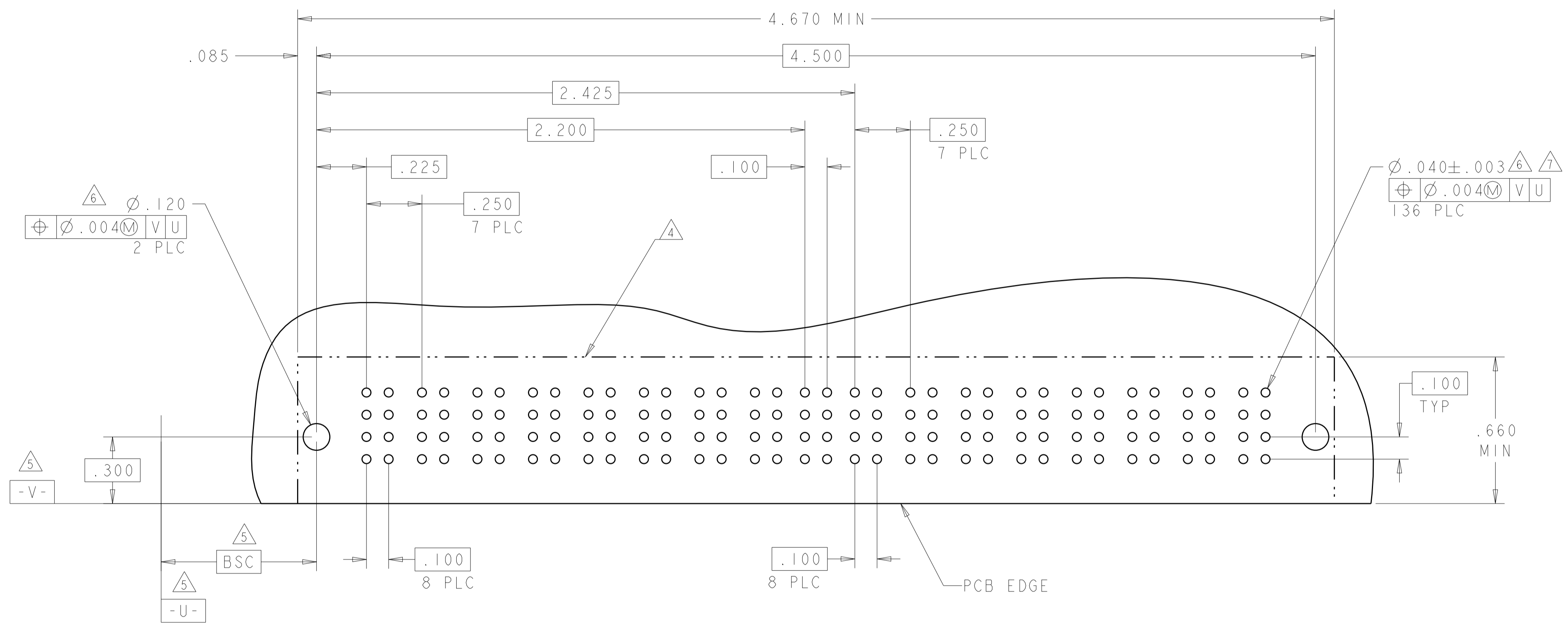

THIS DRAWING IS A CONTROLLED DOCUMENT.		OWN: ALEX SHOAL 14DEC2007	 TE Connectivity
DIMENSIONS: INCHES		CHK: Sunny Zhao 20DEC2007	
TOLERANCES UNLESS OTHERWISE SPECIFIED:		APVD: Sunny Zhao 20DEC2007	NAME: RIGHT ANGLE HEADER W/ LP CONTACT AND SHORT END MODULES MULTI-BEAM XLE
0 PLC ±. 1 PLC ±. 2 PLC ±.01 3 PLC ±.005 4 PLC ±.0050 ANGLES ±.7°		PRODUCT SPEC: 108-2292	SIZE: A100779
MATERIAL: -		APPLICATION SPEC: 114-13251	CAGE CODE: C=6450840
FINISH: -		WEIGHT: -	RESTRICTED TO: -
Customer Drawing		SCALE: 1:1	SHEET 10 OF 16 REV: H4

LOC	DIST	REVISIONS			
P	LTN	DESCRIPTION	DATE	OWN	APVD
ES	00	SEE SHEET 1			

PART NUMBER	ROWS	POWER		SIGNAL								LOW POWER				POWER															
		P1	P2	1	2	3	4	5	6	7	8	LP1	LP2	LP3	LP4	P3	P4	P5	P6	P7	P8	P9	P10	P11	P12	P13	P14	P15	P16		
2-6450840-1	D	TT	TT	Z5	Z5	Z5	Z5	Z5	Z5	Z5	Z5																				
	C			Y5	Y5	Y5	Y5	Y5	Y5	Y5	Y5																				
	B			R5	R5	R5	R5	R5	R5	R5	R5																				
	A			O5	O5	O5	O5	O5	O5	O5	O5																				

2P + 32S + 4LP + 14P

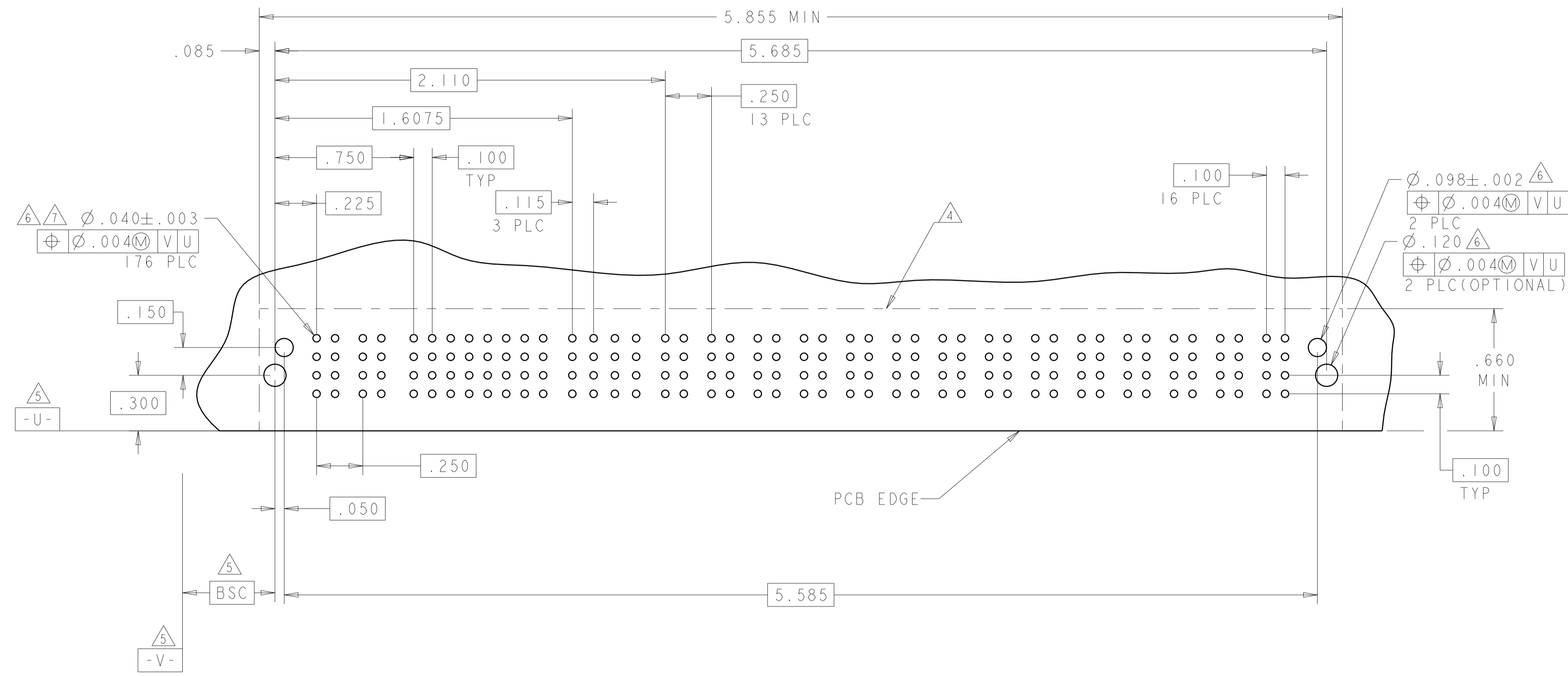

THIS DRAWING IS A CONTROLLED DOCUMENT.

DWN: ALEX SHOAL 14DEC2007	CHK: Sunny Zhao 20DEC2007	APVD: Sunny Zhao 20DEC2007	NAME: RIGHT ANGLE HEADER W/ LP CONTACT AND SHORT END MODULES MULTI-BEAM XLE
DIMENSIONS: INCHES	TOLERANCES UNLESS OTHERWISE SPECIFIED:	PRODUCT SPEC: 108-2292	APPLICATION SPEC: 114-13251
0 PLC ±	1 PLC ±.01	2 PLC ±.01	3 PLC ±.005
4 PLC ±.0050	ANGLES ±.2°	WEIGHT: -	RESTRICTED TO: -
MATERIAL: -	FINISH: -	SCALE: 1:1	SHEET 11 OF 16

Customer Drawing

LOC	DIST	REVISIONS			
P	LTN	DESCRIPTION	DATE	OWN	APVD
ES	00	SEE SHEET 1			

PART NUMBER	ROWS	POWER			SIGNAL						POWER		
		P1	P2	P3	1	2	3	4	5	6	P4	P5	P6
2-6450840-9	D	TT	TT	TT	Z5	Z5	Z5	Z5	Z5	Z5	TT	TT	TT
	C				Y5	Y5	Y5	Y5	Y5	Y5			
	B				R5	R5	R5	R5	R5	R5			
	A				O1	O5	O5	O5	O5	O5			

3P + 24S + 3P

PART NUMBER	ROWS	LOW POWER		SIGNAL				LOW POWER	
		LP1	LP2	1	2	3	4	LP3	LP4
3-6450840-1	D	LT	LT	Z1	Z5	Z5	Z5	LT	LT
	C			Y5	Y5	Y5	Y5		
	B			R5	R5	R5	R5		
	A			O5	O5	O5	O5		

2LP + 16S + 2LP

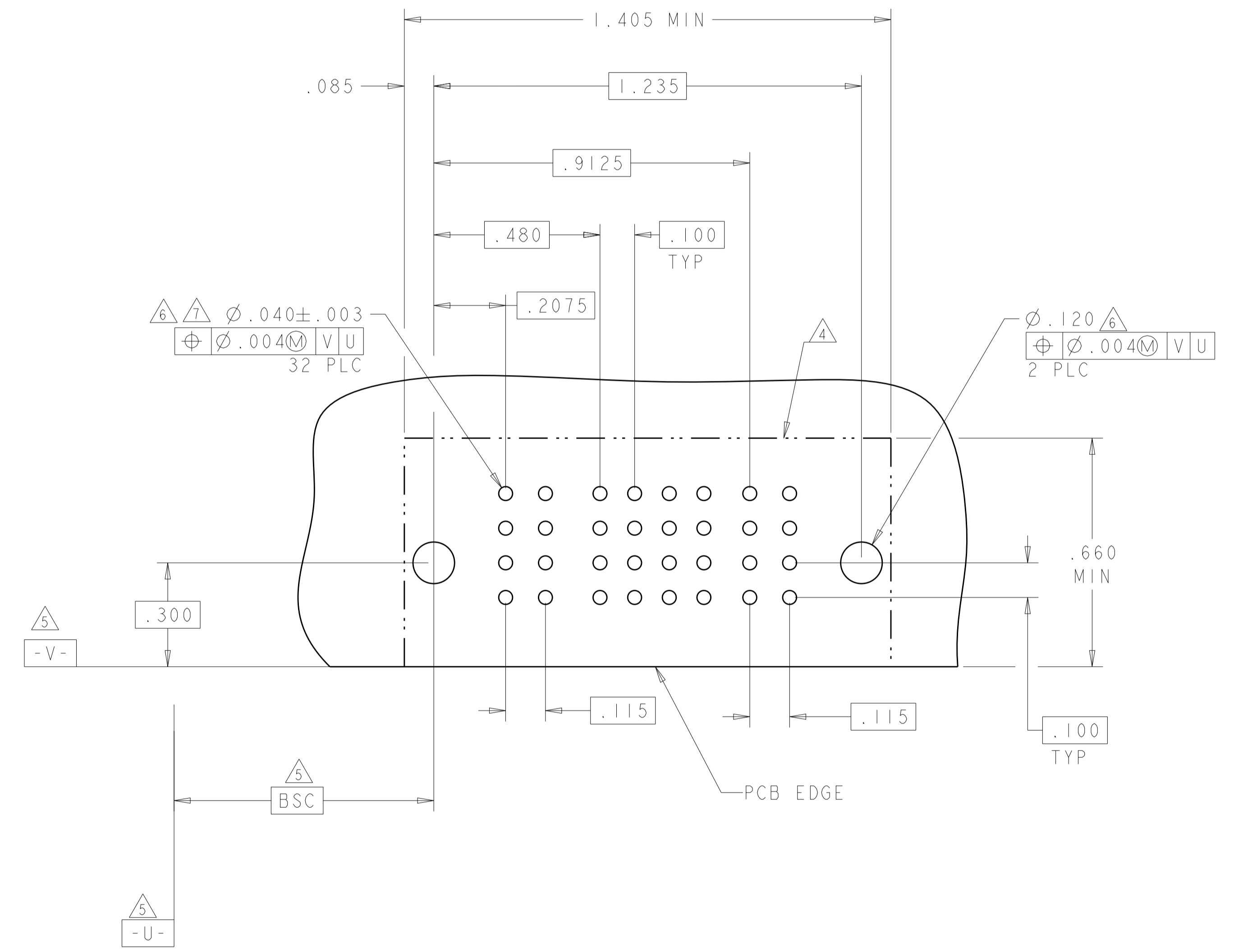
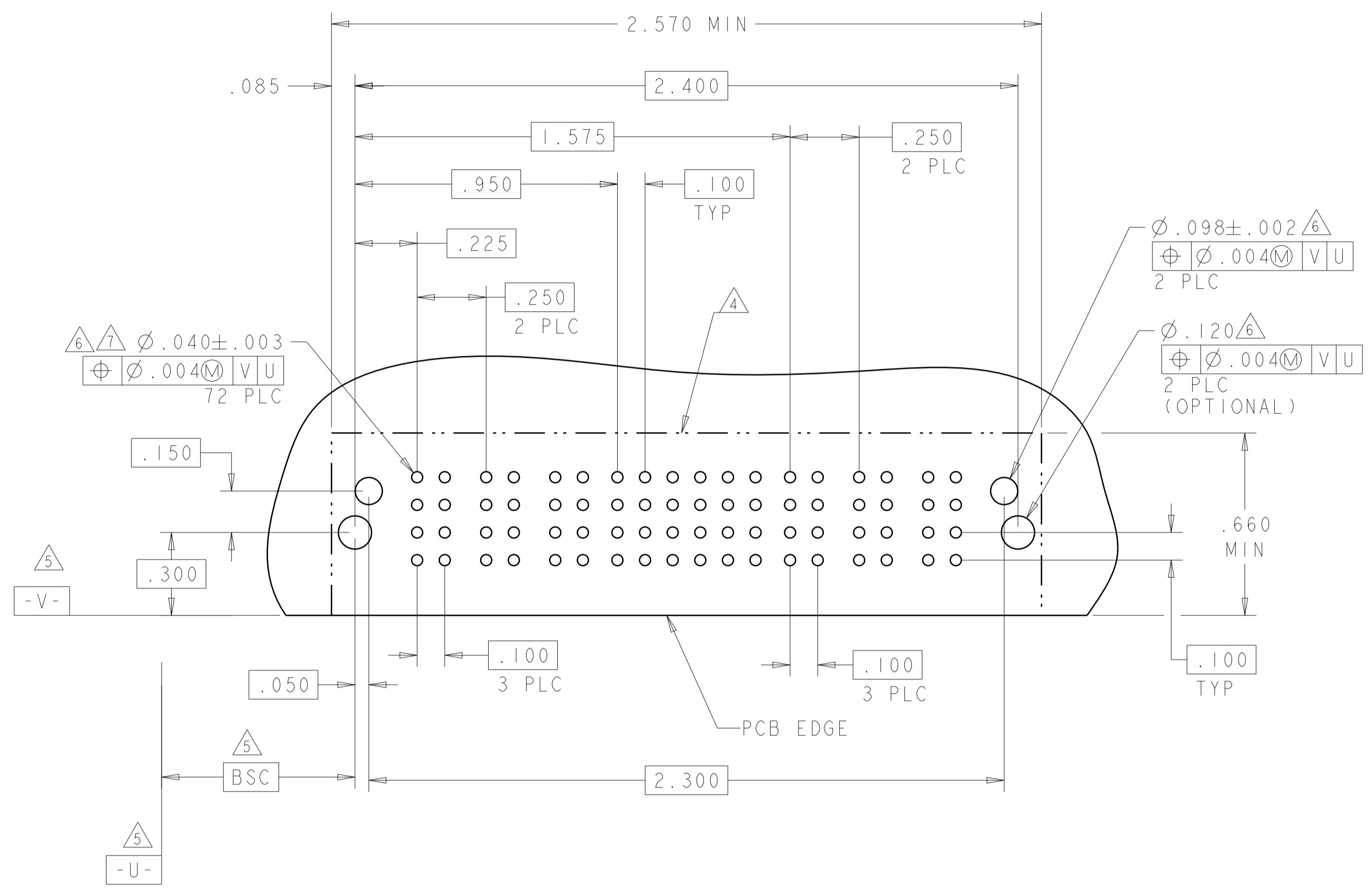

THIS DRAWING IS A CONTROLLED DOCUMENT.		OWN: ALEX SHOAL 14DEC2007	TE Connectivity	
DIMENSIONS: INCHES		CHK: Sunny Zhao 20DEC2007		
TOLERANCES UNLESS OTHERWISE SPECIFIED:		APVD: Sunny Zhao 20DEC2007	NAME: RIGHT ANGLE HEADER W/ LP CONTACT AND SHORT END MODULES MULTI-BEAM XLE	
0 PLC ±.01		PRODUCT SPEC: 108-2292	SIZE: A100779	
1 PLC ±.01		APPLICATION SPEC: 114-13251	CAGE CODE: C=6450840	
2 PLC ±.01		WEIGHT: -	SCALE: 1:1	
3 PLC ±.005		FINISH: -	SHEET 15 OF 16	
4 PLC ±.0050		Customer Drawing	REV: H4	
ANGLES: ±.07°				

LOC	DIST	REVISIONS					
		P	LTN	DESCRIPTION	DATE	DMN	APVD
ES	00	-	-	SEE SHEET 1	-	-	-

PART NUMBER	ROWS	POWER						SIGNAL						POWER				
		LP1	LP2	LP3	LP4	LP5	LP6	1	2	3	4	5	6	P1	P2	P3		
3-6450840-3	D C B A	[HD]	[LT]	[LT]	[LT]	[LT]	[LT]	[LT]	Z5	Z5	Z5	Z5	Z5	Z5	[TT]	[TT]	[TT]	[HD]
			[LT]	[LT]	[LT]	[LT]	[LT]	[LT]	Y5	Y5	Y5	Y5	Y5	Y5	[TT]	[TT]	[TT]	
			[LT]	[LT]	[LT]	[LT]	[LT]	[LT]	R5	R5	R5	R5	R5	R5	[TT]	[TT]	[TT]	
6LP + 24S + 3P								O5	O5	O5	O5	O5	O5					

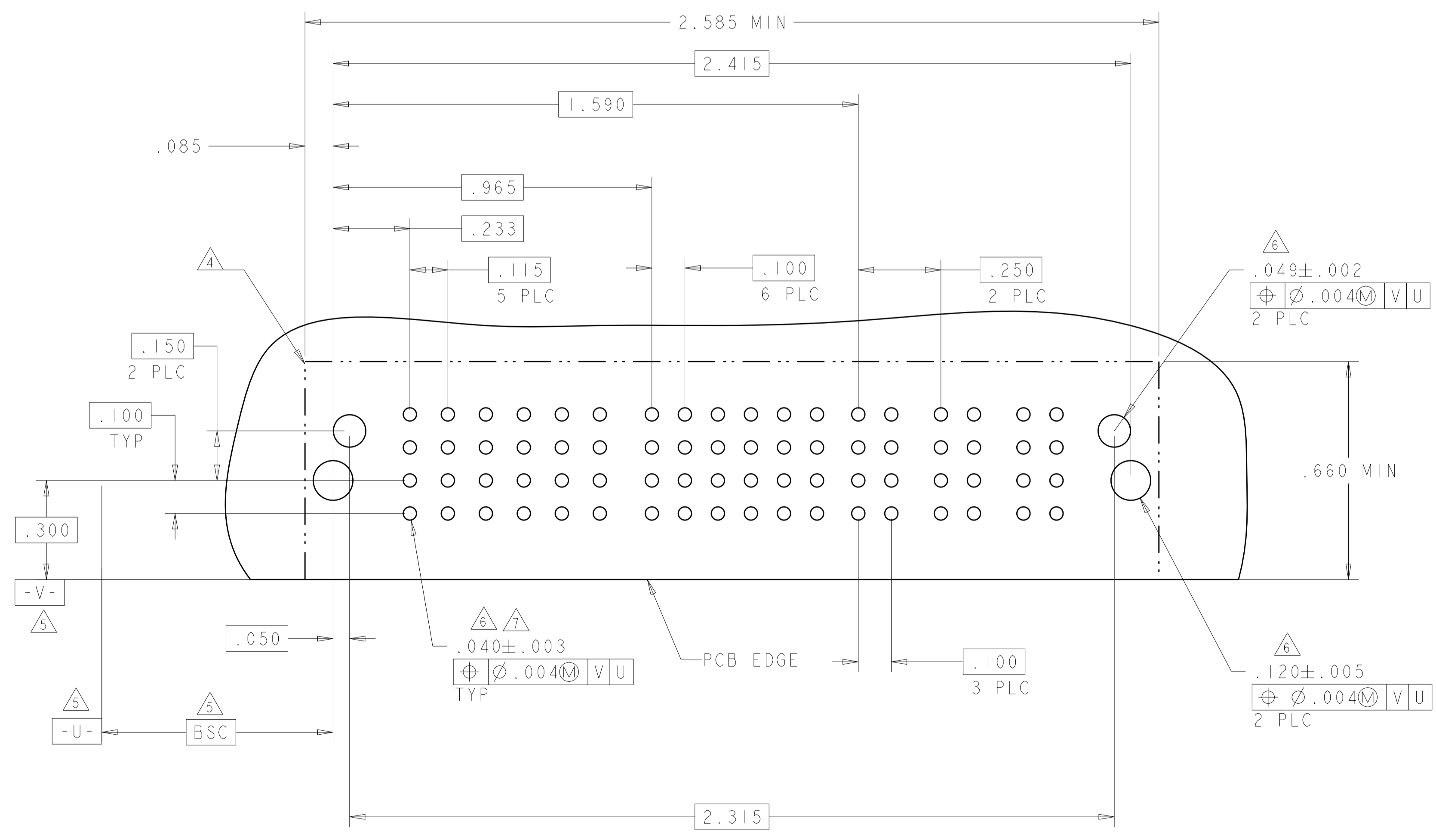

THIS DRAWING IS A CONTROLLED DOCUMENT.		DMN	ALEX SHOAL	14DEC2007	TE Connectivity
DIMENSIONS: INCHES		CHK	Sunny Zhao	20DEC2007	
TOLERANCES UNLESS OTHERWISE SPECIFIED: 0 PLC ±. 1 PLC ±.01 2 PLC ±.01 3 PLC ±.005 4 PLC ±.0050 ANGLES ±.7° FINISH		APVD	Sunny Zhao	20DEC2007	NAME
MATERIAL		PRODUCT SPEC		108-2292	RIGHT ANGLE HEADER W/ LP CONTACT AND SHORT END MODULES MULTI-BEAM XLE
SCALE 1:1		APPLICATION SPEC		114-13251	SIZE
SHEET 16 OF 16		WEIGHT		-	CAGE CODE
REV H4		CUSTOMER DRAWING		A100779	DRAWING NO
				C=6450840	RESTRICTED TO



Компания «ЭлектроПласт» предлагает заключение долгосрочных отношений при поставках импортных электронных компонентов на взаимовыгодных условиях!

Наши преимущества:

- Оперативные поставки широкого спектра электронных компонентов отечественного и импортного производства напрямую от производителей и с крупнейших мировых складов;
- Поставка более 17-ти миллионов наименований электронных компонентов;
- Поставка сложных, дефицитных, либо снятых с производства позиций;
- Оперативные сроки поставки под заказ (от 5 рабочих дней);
- Экспресс доставка в любую точку России;
- Техническая поддержка проекта, помощь в подборе аналогов, поставка прототипов;
- Система менеджмента качества сертифицирована по Международному стандарту ISO 9001;
- Лицензия ФСБ на осуществление работ с использованием сведений, составляющих государственную тайну;
- Поставка специализированных компонентов (Xilinx, Altera, Analog Devices, Intersil, Interpoint, Microsemi, Aeroflex, Peregrine, Syfer, Eurofarad, Texas Instrument, Miteq, Cobham, E2V, MA-COM, Hittite, Mini-Circuits, General Dynamics и др.);

Помимо этого, одним из направлений компании «ЭлектроПласт» является направление «Источники питания». Мы предлагаем Вам помощь Конструкторского отдела:

- Подбор оптимального решения, техническое обоснование при выборе компонента;
- Подбор аналогов;
- Консультации по применению компонента;
- Поставка образцов и прототипов;
- Техническая поддержка проекта;
- Защита от снятия компонента с производства.



Как с нами связаться

Телефон: 8 (812) 309 58 32 (многоканальный)

Факс: 8 (812) 320-02-42

Электронная почта: org@eplast1.ru

Адрес: 198099, г. Санкт-Петербург, ул. Калинина, дом 2, корпус 4, литера А.