

40V NPN SILICON PLANAR MEDIUM POWER TRANSISTOR IN SOT23

Feature

- $BV_{CEO} > 40V$
- $I_C = 1A$ Continuous Collector Current
- $I_{CM} = 2A$ Peak Pulse Current
- $R_{CE(sat)} = 195m\Omega$ for a low equivalent On-Resistance
- 500mW Power Dissipation
- h_{FE} characterised up to 2A for high current gain hold up
- **Totally Lead-Free & Fully RoHS compliant (Notes 1 & 2)**
- **Halogen and Antimony Free. "Green" Device (Note 3)**
- **Qualified to AEC-Q101 Standards for High Reliability**
- **PPAP capable (Note 4)**

Mechanical Data

- Case: SOT23
- Case Material: molded plastic, "Green" molding compound
- UL Flammability Classification Rating 94V-0
- Moisture Sensitivity: Level 1 per J-STD-020
- Terminals: Finish – Matte Tin Plated Leads, Solderable per MIL-STD-202, Method 208
- Weight 0.008 grams (approximate)



Top View

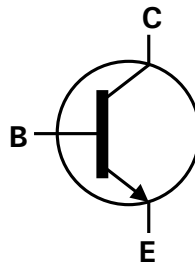

Device Symbol

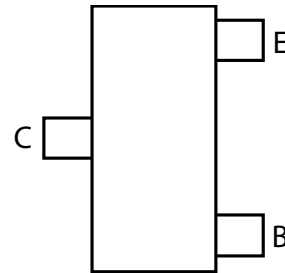

Top View
Pin-Out

Ordering Information (Notes 4 & 5)

Part Number	Compliance	Marking	Reel size (inches)	Tape width (mm)	Quantity per reel
FMMT491ATA	AEC-Q101	41A	7	8	3,000
FMMT491ATC	AEC-Q101	41A	13	8	10,000
FMMT491AQTA	Automotive	41A	7	8	3,000
FMMT491AQTC	Automotive	41A	13	8	10,000

- Notes:
1. No purposely added lead. Fully EU Directive 2002/95/EC (RoHS) & 2011/65/EU (RoHS 2) compliant.
 2. See <http://www.diodes.com> for more information about Diodes Incorporated's definitions of Halogen and Antimony free, "Green" and Lead-Free.
 3. Halogen and Antimony free "Green" products are defined as those which contain <900ppm bromine, <900ppm chlorine (<1500ppm total Br + Cl) and <1000ppm antimony compounds.
 4. Automotive products are AEC-Q101 qualified and are PPAP capable. Automotive, AEC-Q101 and standard products are electrically and thermally the same, except where specified.
 5. For packaging details, go to our website at <http://www.diodes.com>

Marking Information

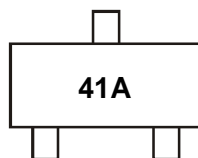

41A = Product Type Marking Code

Maximum Ratings (@T_A = +25°C, unless otherwise specified.)

Characteristic	Symbol	Value	Unit
Collector-Base Voltage	V _{CB0}	40	V
Collector-Emitter Voltage	V _{CEO}	40	V
Emitter-Base Voltage	V _{EBO}	7	V
Continuous Collector Current	I _C	1	A
Peak Pulse Current	I _{CM}	2	A
Base Current	I _B	200	mA

Thermal Characteristics (@T_A = +25°C, unless otherwise specified.)

Characteristic	Symbol	Value	Unit
Power Dissipation (Note 6)	P _D	500	mW
Thermal Resistance, Junction to Ambient (Note 6)	R _{θJA}	250	°C/W
Thermal Resistance, Junction to Lead (Note 7)	R _{θJL}	197	°C/W
Operating and Storage Temperature Range	T _J , T _{STG}	-55 to +150	°C

ESD Ratings (Note 8)

Characteristic	Symbol	Value	Unit	JEDEC Class
Electrostatic Discharge - Human Body Model	ESD HBM	≥ 8,000	V	3B
Electrostatic Discharge - Machine Model	ESD MM	≥ 400	V	C

- Notes:
- 6. For a device surface mounted on 15mm X 15mm FR4 PCB with high coverage of single sided 1 oz copper, in still air conditions; the device is measured when operating in a steady-state condition.
 - 7. Thermal resistance from junction to solder-point (at the end of the collector lead).
 - 8. Refer to JEDEC specification JESD22-A114 and JESD22-A115.

Thermal Characteristics and Derating Information

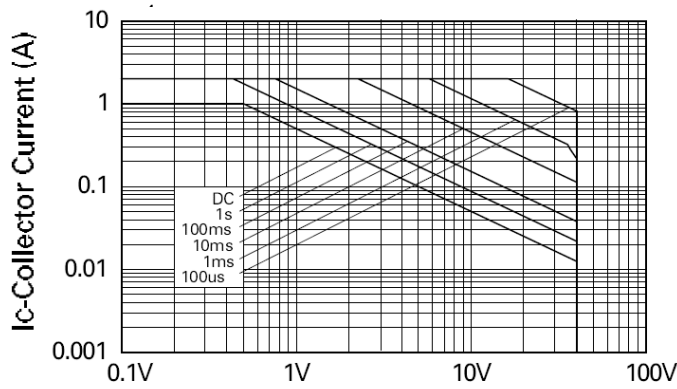

VCE - Collector Emitter Voltage (V)
Safe Operating Area

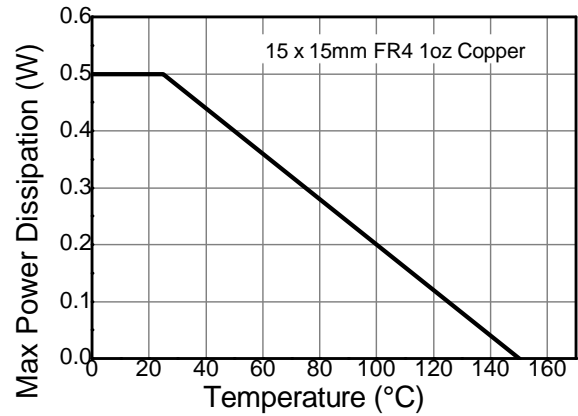

Derating Curve

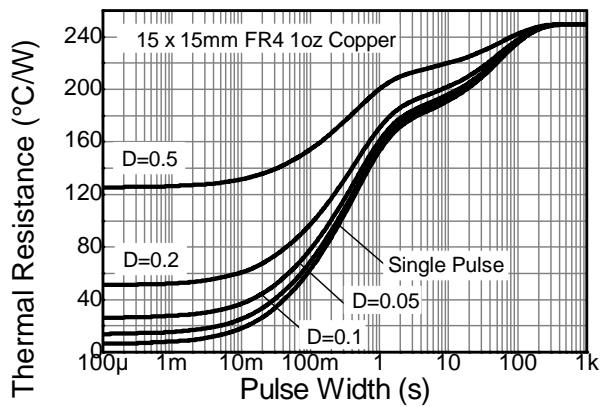

Transient Thermal Impedance

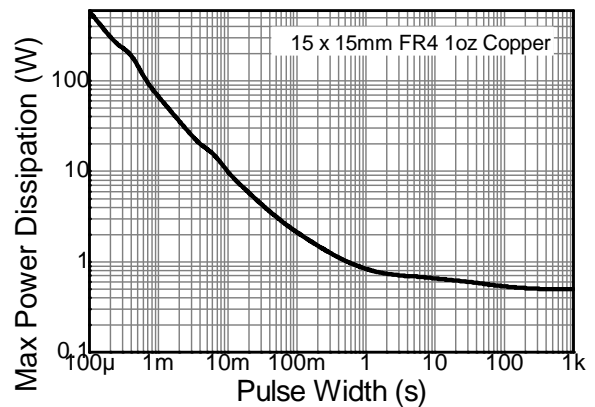

Pulse Power Dissipation

Electrical Characteristics (@T_A = +25°C, unless otherwise specified.)

Characteristic	Symbol	Min	Typ	Max	Unit	Test Condition
Collector-Base Breakdown Voltage	BV_{CBO}	40	—	—	V	$I_C = 100\mu A$
Collector-Emitter Breakdown Voltage (Note 9)	BV_{CEO}	40	—	—	V	$I_C = 10mA$
Emitter-Base Breakdown Voltage	BV_{EBO}	7	—	—	V	$I_E = 100\mu A$
Collector Cutoff Current	I_{CBO}	—	—	100	nA	$V_{CB} = 30V, V_{CES} = 30V$
Emitter Cutoff Current	I_{EBO}	—	—	100	nA	$V_{EB} = 5V$
Collector Emitter Cutoff Current	I_{CES}	—	—	100	nA	$V_{CE} = 30V, V_{CES} = 30V$
Static Forward Current Transfer Ratio (Note 9)	h_{FE}	300	—	—	—	$I_C = 1mA, V_{CE} = 5V$
		300	—	900		$I_C = 500mA, V_{CE} = 5V$
		200	—	—		$I_C = 1A, V_{CE} = 5V$
		35	—	—		$I_C = 2A, V_{CE} = 5V$
Collector-Emitter Saturation Voltage (Note 9)	$V_{CE(sat)}$	—	—	0.3	V	$I_C = 500mA, I_B = 50mA$
		—	—	0.5		$I_C = 1A, I_B = 100mA$
Base-Emitter Turn-On Voltage(Note 9)	$V_{BE(on)}$	—	—	1.0	V	$I_C = 1A, V_{CE} = 5V$
Base-Emitter Saturation Voltage(Note 9)	$V_{BE(sat)}$	—	—	1.1	V	$I_C = 1A, I_B = 100mA$
Output Capacitance	C_{obo}	—	—	10	pF	$V_{CB} = 10V, f = 1MHz$
Transition Frequency	f_T	150	—	—	MHz	$V_{CE} = 10V, I_C = 50mA, f = 100MHz$

Notes: 9. Measured under pulsed conditions. Pulse width $\leq 300\mu s$. Duty cycle $\leq 2\%$.

Typical Electrical Characteristics (@ $T_A = +25^\circ\text{C}$, unless otherwise specified.)

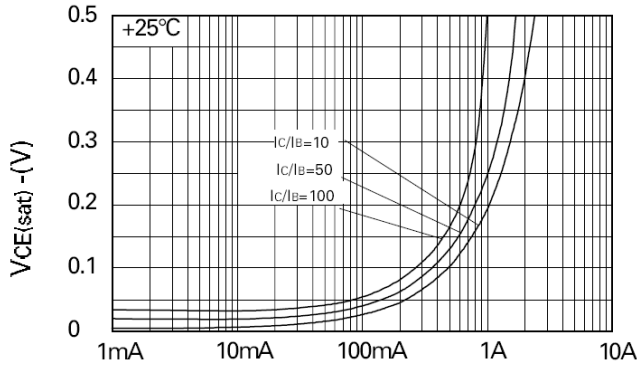

IC-Collector Current

$V_{CE(sat)} \text{ v } I_C$

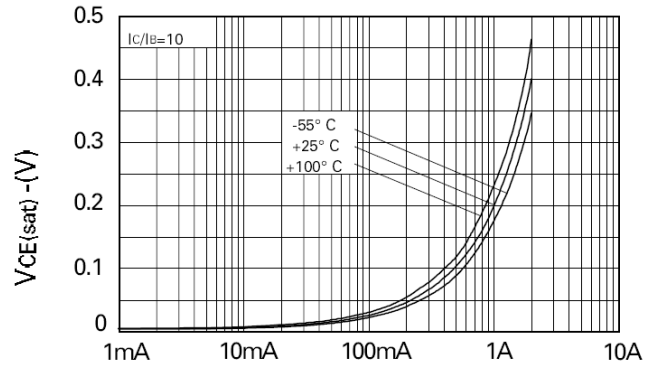

IC-Collector Current

$V_{CE(sat)} \text{ v } I_C$

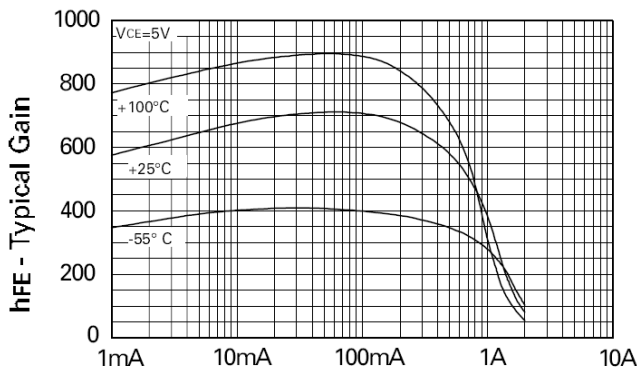

IC-Collector Current

$h_{FE} \text{ v } I_C$

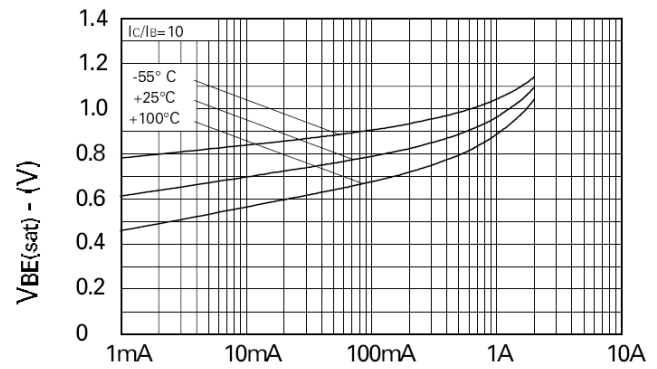

IC-Collector Current

$V_{BE(sat)} \text{ v } I_C$

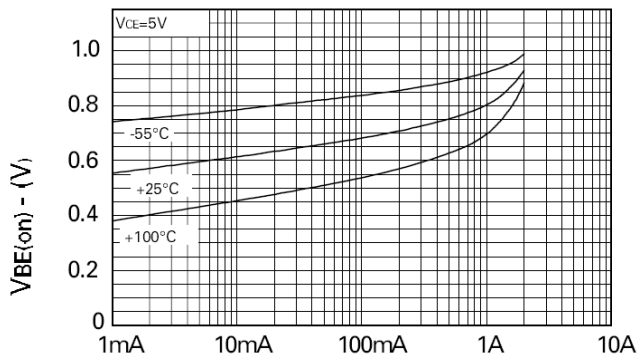

IC-Collector Current

$V_{BE(on)} \text{ v } I_C$

Package Outline Dimensions

Please see AP02002 at <http://www.diodes.com/datasheets/ap02002.pdf> for latest version.

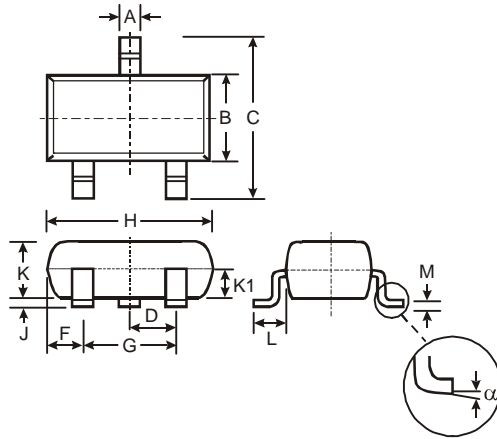

SOT23			
Dim	Min	Max	Typ
A	0.37	0.51	0.40
B	1.20	1.40	1.30
C	2.30	2.50	2.40
D	0.89	1.03	0.915
F	0.45	0.60	0.535
G	1.78	2.05	1.83
H	2.80	3.00	2.90
J	0.013	0.10	0.05
K	0.903	1.10	1.00
K1	-	-	0.400
L	0.45	0.61	0.55
M	0.085	0.18	0.11
α	0°	8°	-
All Dimensions in mm			

Suggested Pad Layout

Please see AP02001 at <http://www.diodes.com/datasheets/ap02001.pdf> for the latest version.

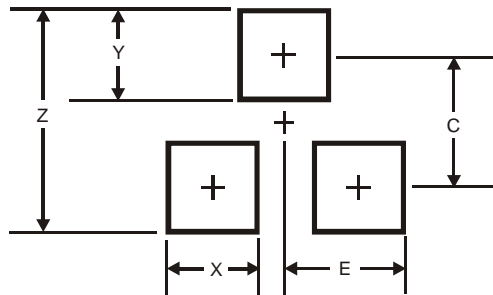

Dimensions	Value (in mm)
Z	2.9
X	0.8
Y	0.9
C	2.0
E	1.35

IMPORTANT NOTICE

DIODES INCORPORATED MAKES NO WARRANTY OF ANY KIND, EXPRESS OR IMPLIED, WITH REGARDS TO THIS DOCUMENT, INCLUDING, BUT NOT LIMITED TO, THE IMPLIED WARRANTIES OF MERCHANTABILITY AND FITNESS FOR A PARTICULAR PURPOSE (AND THEIR EQUIVALENTS UNDER THE LAWS OF ANY JURISDICTION).

Diodes Incorporated and its subsidiaries reserve the right to make modifications, enhancements, improvements, corrections or other changes without further notice to this document and any product described herein. Diodes Incorporated does not assume any liability arising out of the application or use of this document or any product described herein; neither does Diodes Incorporated convey any license under its patent or trademark rights, nor the rights of others. Any Customer or user of this document or products described herein in such applications shall assume all risks of such use and will agree to hold Diodes Incorporated and all the companies whose products are represented on Diodes Incorporated website, harmless against all damages.

Diodes Incorporated does not warrant or accept any liability whatsoever in respect of any products purchased through unauthorized sales channel. Should Customers purchase or use Diodes Incorporated products for any unintended or unauthorized application, Customers shall indemnify and hold Diodes Incorporated and its representatives harmless against all claims, damages, expenses, and attorney fees arising out of, directly or indirectly, any claim of personal injury or death associated with such unintended or unauthorized application.

Products described herein may be covered by one or more United States, international or foreign patents pending. Product names and markings noted herein may also be covered by one or more United States, international or foreign trademarks.

This document is written in English but may be translated into multiple languages for reference. Only the English version of this document is the final and determinative format released by Diodes Incorporated.

LIFE SUPPORT

Diodes Incorporated products are specifically not authorized for use as critical components in life support devices or systems without the express written approval of the Chief Executive Officer of Diodes Incorporated. As used herein:

A. Life support devices or systems are devices or systems which:

1. are intended to implant into the body, or
2. support or sustain life and whose failure to perform when properly used in accordance with instructions for use provided in the labeling can be reasonably expected to result in significant injury to the user.

B. A critical component is any component in a life support device or system whose failure to perform can be reasonably expected to cause the failure of the life support device or to affect its safety or effectiveness.

Customers represent that they have all necessary expertise in the safety and regulatory ramifications of their life support devices or systems, and acknowledge and agree that they are solely responsible for all legal, regulatory and safety-related requirements concerning their products and any use of Diodes Incorporated products in such safety-critical, life support devices or systems, notwithstanding any devices- or systems-related information or support that may be provided by Diodes Incorporated. Further, Customers must fully indemnify Diodes Incorporated and its representatives against any damages arising out of the use of Diodes Incorporated products in such safety-critical, life support devices or systems.

Copyright © 2012, Diodes Incorporated

www.diodes.com



Компания «ЭлектроПласт» предлагает заключение долгосрочных отношений при поставках импортных электронных компонентов на взаимовыгодных условиях!

Наши преимущества:

- Оперативные поставки широкого спектра электронных компонентов отечественного и импортного производства напрямую от производителей и с крупнейших мировых складов;
- Поставка более 17-ти миллионов наименований электронных компонентов;
- Поставка сложных, дефицитных, либо снятых с производства позиций;
- Оперативные сроки поставки под заказ (от 5 рабочих дней);
- Экспресс доставка в любую точку России;
- Техническая поддержка проекта, помощь в подборе аналогов, поставка прототипов;
- Система менеджмента качества сертифицирована по Международному стандарту ISO 9001;
- Лицензия ФСБ на осуществление работ с использованием сведений, составляющих государственную тайну;
- Поставка специализированных компонентов (Xilinx, Altera, Analog Devices, Intersil, Interpoint, Microsemi, Aeroflex, Peregrine, Syfer, Eurofarad, Texas Instrument, Miteq, Cobham, E2V, MA-COM, Hittite, Mini-Circuits, General Dynamics и др.);

Помимо этого, одним из направлений компании «ЭлектроПласт» является направление «Источники питания». Мы предлагаем Вам помощь Конструкторского отдела:

- Подбор оптимального решения, техническое обоснование при выборе компонента;
- Подбор аналогов;
- Консультации по применению компонента;
- Поставка образцов и прототипов;
- Техническая поддержка проекта;
- Защита от снятия компонента с производства.



Как с нами связаться

Телефон: 8 (812) 309 58 32 (многоканальный)

Факс: 8 (812) 320-02-42

Электронная почта: org@eplast1.ru

Адрес: 198099, г. Санкт-Петербург, ул. Калинина, дом 2, корпус 4, литера А.