

## Metallized Polyester (PET) SMD Film Capacitors with Box Encapsulation

### Special Features

- Size codes 1812, 2220, 2824, 4030, 5040 and 6054 with PET and encapsulated
- Operating temperature up to 100° C
- Self-healing
- According to RoHS 2011/65/EU

### Typical Applications

For general DC-applications e.g.

- By-pass
- Blocking
- Coupling and decoupling
- Timing

### Construction

#### Dielectric:

Polyethylene-terephthalate (PET) film

#### Capacitor electrodes:

Vacuum-deposited

#### Internal construction:

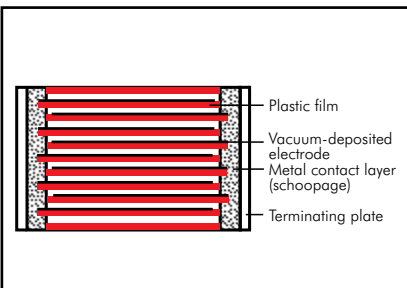

#### Encapsulation:

Solvent-resistant, flame-retardant plastic case, UL 94 V-0

#### Terminations:

Tinned plates.

#### Marking:

Box colour: Black.

### Electrical Data

#### Capacitance range:

0.01 µF to 6.8 µF

#### Rated voltages:

63 VDC, 100 VDC, 250 VDC, 400 VDC, 630 VDC, 1000 VDC

#### Capacitance tolerances:

±20%, ±10% (±5% available subject to special enquiry)

#### Operating temperature range:

-55° C to +100° C (+125° C available subject to special enquiry)

#### Climatic test category:

55/100/21 according to IEC

for size codes 1812 to 2824

55/100/56 according to IEC

for size codes 4030 to 6054

#### Insulation resistance at +20° C:

$U_r$	$U_{test}$	$C \leq 0.33 \mu F$	$0.33 \mu F < C \leq 6.8 \mu F$
63 VDC	50 V	$\geq 3.75 \times 10^3 M\Omega$ (mean value: $1 \times 10^4 M\Omega$ )	$\geq 1250 \text{ sec } (M\Omega \times \mu F)$ (mean value: 3000 sec)
100 VDC	100 V		
$\geq 250 \text{ VDC}$	100 V	$\geq 1 \times 10^4 M\Omega$ (mean value: $5 \times 10^4 M\Omega$ )	$\geq 3000 \text{ sec } (M\Omega \times \mu F)$ (mean value: 10000 sec)

Measuring time: 1 min.

#### Dissipation factors at +20° C: $\tan \delta$

at f	$C \leq 0.1 \mu F$	$0.1 \mu F < C \leq 1.0 \mu F$	$C > 1.0 \mu F$
1 kHz	$\leq 8 \times 10^{-3}$	$\leq 8 \times 10^{-3}$	$\leq 10 \times 10^{-3}$
10 kHz	$\leq 15 \times 10^{-3}$	$\leq 15 \times 10^{-3}$	-
100 kHz	$\leq 30 \times 10^{-3}$	-	-

#### Maximum pulse rise time: for pulses equal to the rated voltage

Capacitance µF	Pulse rise time V/µsec max. operation/test					
	63 VDC	100 VDC	250 VDC	400 VDC	630 VDC	1000 VDC
0.01 ... 0.022	30/300	35/350	40/400	35/350	40/400	50/500
0.033 ... 0.068	20/200	20/200	40/400	21/210	25/250	32/320
0.1 ... 0.22	10/100	10/100	12/120	14/140	17/170	-
0.33 ... 0.68	8/80	6/60	9/90	10/100	-	-
1.0 ... 2.2	3.5/35	4/40	7/70	-	-	-
3.3 ... 6.8	3/30	3/30	-	-	-	-

### Dip Solder Test/Processing

#### Resistance to soldering heat:

Test Tb in accordance with DIN IEC

60068-2-58/DIN EN 60384-19.

Soldering bath temperature max. 260° C.

Soldering duration max. 5 sec.

Change in capacitance  $\Delta C/C < 5\%$ .

#### Soldering process:

Wave soldering and re-flow soldering

(see temperature/time graphs page 12).

### Packing

Available taped and reeled in 12 mm blister pack.

Detailed taping information and graphs at the end of the catalogue.

For further details and graphs please refer to Technical Information.

## Continuation

### General Data

Capacitance	63 VDC/40 VAC*			100 VDC/63 VAC*			250 VDC/160 VAC*		
	Size code	H ± 0.3	Part number	Size code	H ± 0.3	Part number	Size code	H ± 0.3	Part number
0.01 µF	1812	3.0	SMDTC02100KA00	1812	3.0	SMDTD02100KA00	1812	4.0	SMDTF02100KB00
	2220	3.5	SMDTC02100QA00	2220	3.5	SMDTD02100QA00	2220	3.5	SMDTF02100QA00
	2824	3.0	SMDTC02100TA00	2824	3.0	SMDTD02100TA00	2824	3.0	SMDTF02100TA00
0.015 "	1812	3.0	SMDTC02150KA00	1812	3.0	SMDTD02150KA00	1812	4.0	SMDTF02150KB00
	2220	3.5	SMDTC02150QA00	2220	3.5	SMDTD02150QA00	2220	3.5	SMDTF02150QA00
	2824	3.0	SMDTC02150TA00	2824	3.0	SMDTD02150TA00	2824	3.0	SMDTF02150TA00
0.022 "	1812	3.0	SMDTC02220KA00	1812	3.0	SMDTD02220KA00	1812	4.0	SMDTF02220KB00
	2220	3.5	SMDTC02220QA00	2220	3.5	SMDTD02220QA00	2220	3.5	SMDTF02220QA00
	2824	3.0	SMDTC02220TA00	2824	3.0	SMDTD02220TA00	2824	3.0	SMDTF02220TA00
0.033 "	1812	3.0	SMDTC02330KA00	1812	3.0	SMDTD02330KA00	2220	3.5	SMDTF02330QA00
	2220	3.5	SMDTC02330QA00	2220	3.5	SMDTD02330QA00	2824	3.0	SMDTF02330TA00
	2824	3.0	SMDTC02330TA00	2824	3.0	SMDTD02330TA00	4030	5.0	SMDTF02330VA00
0.047 "	1812	3.0	SMDTC02470KA00	1812	3.0	SMDTD02470KA00	2220	3.5	SMDTF02470QA00
	2220	3.5	SMDTC02470QA00	2220	3.5	SMDTD02470QA00	2824	3.0	SMDTF02470TA00
	2824	3.0	SMDTC02470TA00	2824	3.0	SMDTD02470TA00	4030	5.0	SMDTF02470VA00
0.068 "	1812	3.0	SMDTC02680KA00	1812	3.0	SMDTD02680KA00	2220	3.5	SMDTF02680QA00
	2220	3.5	SMDTC02680QA00	2220	3.5	SMDTD02680QA00	2824	3.0	SMDTF02680TA00
	2824	3.0	SMDTC02680TA00	2824	3.0	SMDTD02680TA00	4030	5.0	SMDTF02680VA00
0.1 µF	1812	3.0	SMDTC03100KA00	1812	3.0	SMDTD03100KA00	2220	3.5	SMDTF03100QA00
	2220	3.5	SMDTC03100QA00	2220	3.5	SMDTD03100QA00	2824	5.0	SMDTF03100TB00
	2824	3.0	SMDTC03100TA00	2824	3.0	SMDTD03100TA00	4030	5.0	SMDTF03100VA00
0.15 "	1812	3.0	SMDTC03150KA00	1812	4.0	SMDTD03150KB00	2220	4.5	SMDTF03150QB00
	2220	3.5	SMDTC03150QA00	2220	3.5	SMDTD03150QA00	2824	5.0	SMDTF03150TB00
	2824	3.0	SMDTC03150TA00	2824	3.0	SMDTD03150TA00	4030	5.0	SMDTF03150VA00
0.22 "	1812	3.0	SMDTC03220KA00	1812	4.0	SMDTD03220KB00	2220	4.5	SMDTF03220QB00
	2220	3.5	SMDTC03220QA00	2220	3.5	SMDTD03220QA00	2824	5.0	SMDTF03220TB00
	2824	3.0	SMDTC03220TA00	2824	3.0	SMDTD03220TA00	4030	5.0	SMDTF03220VA00
0.33 "	1812	4.0	SMDTC03330KB00	2220	4.5	SMDTD03330QB00	2824	5.0	SMDTF03330TB00
	2220	3.5	SMDTC03330QA00	2824	5.0	SMDTD03330TB00	4030	5.0	SMDTF03330VA00
	2824	3.0	SMDTC03330TA00	4030	5.0	SMDTD03330VA00	5040	6.0	SMDTF03330XA00
0.47 "	1812	4.0	SMDTC03470KB00	2220	4.5	SMDTD03470QB00	4030	5.0	SMDTF03470VA00
	2220	3.5	SMDTC03470QA00	2824	5.0	SMDTD03470TB00	5040	6.0	SMDTF03470XA00
	2824	3.0	SMDTC03470TA00	4030	5.0	SMDTD03470VA00			
0.68 "	2220	4.5	SMDTC03680QB00	2824	5.0	SMDTD03680TB00	5040	6.0	SMDTF03680XA00
	2824	3.0	SMDTC03680TA00	4030	5.0	SMDTD03680VA00			
	4030	5.0	SMDTC03680VA00	5040	6.0	SMDTD03680XA00			
1.0 µF	2220	4.5	SMDTC04100QB00	2824	5.0	SMDTD04100TB00	6054	7.0	SMDTF04100YA00
	2824	3.0	SMDTC04100TA00	4030	5.0	SMDTD04100VA00			
	4030	5.0	SMDTC04100VA00	5040	6.0	SMDTD04100XA00			
1.5 "	2824	5.0	SMDTC04150TB00	4030	5.0	SMDTD04150VA00			
	4030	5.0	SMDTC04150VA00	5040	6.0	SMDTD04150XA00			
2.2 "	2824	5.0	SMDTC04220TB00	5040	6.0	SMDTD04220XA00			
	4030	5.0	SMDTC04220VA00						
3.3 "	4030	5.0	SMDTC04330VA00	5040	6.0	SMDTD04330XA00			
4.7 "	5040	6.0	SMDTC04470XA00	6054	7.0	SMDTD04470YA00			
6.8 "	6054	7.0	SMDTC04680YA00						

Part number completion:  
Tolerance: 20 % = M  
              10 % = K  
              5 % = J  
Packing: bulk = S  
Pin length: none = 00  
Taped version see page 143.

\* AC voltage:  $f = 50 \text{ Hz}; 1.4 \times U_{\text{rms}} + U_{\text{DC}} \leq U_r$

Dims. in mm.

Rights reserved to amend design data without prior notification.

## Continuation

### General Data

Capacitance	400 VDC/200 VAC*			630 VDC/300 VAC*			1000 VDC/400 VAC*		
	Size code	H ± 0.3	Part number	Size code	H ± 0.3	Part number	Size code	H ± 0.3	Part number
0.01 $\mu$ F	2824 4030	3.0 5.0	SMDTG02100TA00_____ SMDTG02100VA00_____ SMDTG02100XA00_____	4030	5.0	SMDTJ02100VA00_____ SMDTJ02100XA00_____			
0.015 "	2824 4030	3.0 5.0	SMDTG02150TA00_____ SMDTG02150VA00_____ SMDTG02150XA00_____	4030	5.0	SMDTJ02150VA00_____ SMDTJ02150XA00_____	5040	6.0	SMDTO12150XA00_____ SMDTO12150YA00_____
0.022 "	2824 4030	3.0 5.0	SMDTG02220TA00_____ SMDTG02220VA00_____ SMDTG02220XA00_____	5040	6.0	SMDTJ02220XA00_____ SMDTJ02220YA00_____	5040	6.0	SMDTO12220XA00_____ SMDTO12220YA00_____
0.033 "	2824 4030	5.0 5.0	SMDTG02330TB00_____ SMDTG02330VA00_____ SMDTG02330XA00_____	5040	6.0	SMDTJ02330XA00_____ SMDTJ02330YA00_____	5040	6.0	SMDTO12330XA00_____ SMDTO12330YA00_____
0.047 "	2824 4030	5.0 5.0	SMDTG02470TB00_____ SMDTG02470VA00_____ SMDTG02470XA00_____	5040	6.0	SMDTJ02470XA00_____ SMDTJ02470YA00_____	6054	7.0	SMDTO12470YA00_____ SMDTO12470XA00_____
0.068 "	4030 5040	5.0 6.0	SMDTG02680VA00_____ SMDTG02680XA00_____ SMDTG02680YA00_____	5040	6.0	SMDTJ02680XA00_____ SMDTJ02680YA00_____			
0.1 $\mu$ F	4030 5040	5.0 6.0	SMDTG03100VA00_____ SMDTG03100XA00_____ SMDTG03100YA00_____	6054	7.0	SMDTJ03100YA00_____ SMDTJ03100XA00_____			
0.15 "	4030 5040	5.0 6.0	SMDTG03150VA00_____ SMDTG03150XA00_____ SMDTG03150YA00_____	6054	7.0	SMDTJ03150YA00_____ SMDTJ03150XA00_____			
0.22 "	5040	6.0	SMDTG03220XA00_____ SMDTG03220YA00_____	6054	7.0	SMDTJ03220YA00_____ SMDTJ03220XA00_____			
0.33 "	5040	6.0	SMDTG03330XA00_____ SMDTG03330YA00_____						
0.47 "	6054	7.0	SMDTG03470YA00_____ SMDTG03470XA00_____						

\* AC voltage:  $f = 50 \text{ Hz}$ ;  $1.4 \times U_{\text{rms}} + U_{\text{DC}} \leq U_r$

Dims. in mm.

Solder pad recommendation

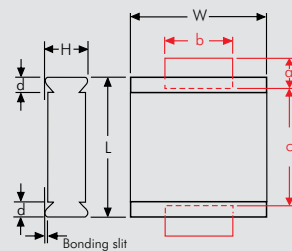

Part number completion:

Tolerance: 20 % = M  
10 % = K  
5 % = J

Packing: bulk = S  
Pin length: none = 00

Taped version see page 143.

The values of the WIMA SMD-PEN range according to the main catalogue 2009 are still available on request.

Size code	L ±0.3	W ±0.3	d	a min.	b min.	c max.
1812	4.8	3.3	0.5	1.2	3.5	3.5
2220	5.7	5.1	0.5	1.2	4	4.5
2824	7.2	6.1	0.5	1.2	4	6.5
4030	10.2	7.6	0.5	2.5	6	9
5040	12.7	10.2	0.7	2.5	6	11.5
6054	15.3	13.7	0.7	2.5	6	14

# Recommendation for Processing and Application of SMD Capacitors

## Layout Form

The components can generally be positioned on the carrier material as desired. In order to prevent soldering shadows or ensure regular temperature distribution, extreme concentration of the components should be avoided. In practice, it has proven best to keep a minimum distance of the soldering surfaces between two WIMA SMDs of twice the height of the components.

## Solder Pad Recommendation

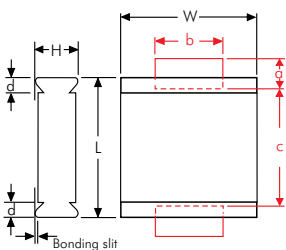

Size code	L ± 0.3	W ± 0.3	d	a min.	b min.	c max.
1812	4.8	3.3	0.5	1.2	3.5	3.5
2220	5.7	5.1	0.5	1.2	4	4.5
2824	7.2	6.1	0.5	1.2	4	6.5
4030	10.2	7.6	0.5	2.5	6	9
5040	12.7	10.2	0.7	2.5	6	11.5
6054	15.3	13.7	0.7	2.5	6	14

The solder pad size recommendations given for each individual series are to be understood as minimum dimensions which can at any time be adjusted to the layout form.

## Processing

The processing of SMD components

- assembling
- soldering
- electrical final inspection/ calibrating

must be regarded as a complete process. The soldering of the printed circuit board, for example, can constitute considerable stress on all the electronic components. The manufacturer's instructions on the processing of the components are mandatory.

## Soldering Process

### Re-flow soldering

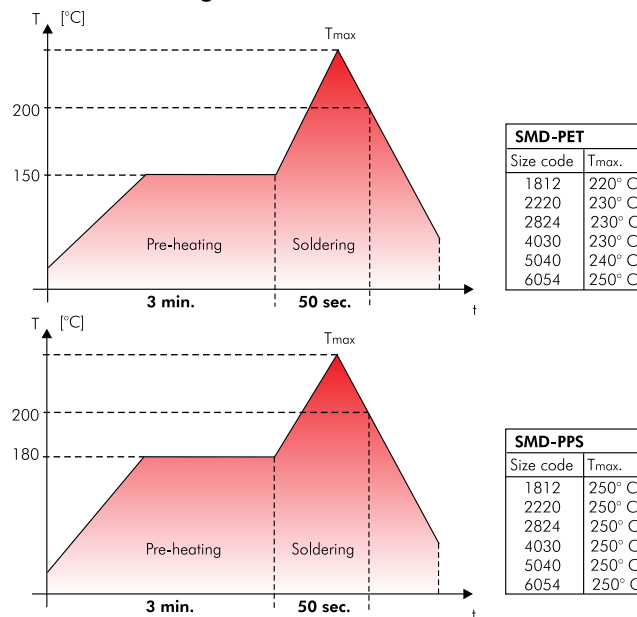

Temperature/time graph for the permissible processing temperature of the WIMA SMD film capacitor for typical convection soldering processes.

Due to the diverse procedures and the varying heat requirements of the different types of components, an exact processing temperature for re-flow soldering processes cannot be specified. The graph shows the upper limits of temperature and time which

must not be exceeded when establishing the solder profile according to your actual requirements. As short term limit a max. temperature of T = 210° C inside the component should not be exceeded when processing WIMA SMD capacitors.

## SMD Handsoldering

WIMA SMD capacitors with plastic film dielectric are generally suitable for hand-soldering, e.g. for lab purposes, with a soldering iron where, however, similar to automated soldering processes, a certain duration and temperature should not be exceeded. These parameters are dependent on the physical size of the components and the relevant heat absorption involved.

The below data are to be regarded as guideline values and should serve to avoid damage to the dielectric caused by excessive heat during the soldering process. The soldering quality depends on the tool used and on the skill and experience of the person with the soldering iron in hand.

Size code	Temperature °C / °F	Time duration
1812	250 / 482	2 sec plate 1 / 5 sec off / 2 sec plate 2
2220	250 / 482	3 sec plate 1 / 5 sec off / 3 sec plate 2
2824	260 / 500	3 sec plate 1 / 5 sec off / 3 sec plate 2
4030	260 / 500	5 sec plate 1 / 5 sec off / 5 sec plate 2
5040	260 / 500	5 sec plate 1 / 5 sec off / 5 sec plate 2
6054	260 / 500	5 sec plate 1 / 5 sec off / 5 sec plate 2

## Recommendation for Processing and Application of SMD Capacitors (Continuation)

### Solder Paste

To obtain the best soldering performance we suggest the use of following solder paste alloy:

#### Lead free solder paste

Sn - Bi  
Sn - Zn (Bi)  
Sn - Ag - Cu (suitable for SMD-PET 5040/6054 and SMD-PPS)

#### Solder paste with lead

Sn - Pb - Ag (Sn60-Pb40-A, Sn63-Pb37-A)

### Washing

WIMA SMD components with plastic encapsulation - like all other components of similar construction irrespective of the make - cannot be regarded as hermetically sealed. Due to today's common washing substances, e. g. on aqueous basis instead of the formerly used halogenated hydrocarbons, with enhanced washing efficiency it became obvious that assembled SMD capacitors may show an impermissibly high deviation of the electrical parameters after a corresponding washing process. Hence it is recommended to refrain from applying industrial washing processes for WIMA SMD capacitors in order to avoid possible damages.

### Initial Operation/Calibration

Due to the stress which the components are subjected to during processing, reversible parameter changes occur in almost all electronic components. The capacitance recovery accuracy to be expected with careful processing is within a scope of

$$|\Delta C/C| \leq 5 \%$$

For the initial operation of the device a minimum storage time of

$$t \geq 24 \text{ hours}$$

is to be taken into account. With calibrated devices or when the application is largely dependent on capacitance it is

advisable to prolong the storage time to

$$t \geq 10 \text{ days}$$

In this way ageing effects of the capacitor structure can be anticipated. Parameter changes due to processing are not to be expected after this period of time

### Humidity Protection Bags

Taped WIMA SMD capacitors are shipped in humidity protection bags according to JEDEC standard, level 1 (EMI/static-shielding bags conforming to MIL-B 81705, Type 1, Class 1). Under controlled conditions the components can be stored two years and more in the originally sealed bag. Opened packing units should be consumed instantly or resealed for specific storage under controlled conditions.

### Reliability

Taking account of the manufacturer's guidelines and compatible processing, the WIMA SMD stand out for the same high quality and reliability as the analogous through-hole WIMA series. The technology of metallized film capacitors used e.g. in WIMA SMD-PET achieves the best values for all fields of application. The expected value is about:

$$\lambda_0 \leq 2 \text{ fit}$$

Furthermore the production of all WIMA components is subject to the regulations laid down by ISO 9001:2008 as well as the guidelines for component specifications set out by IEC quality assessment system (IECQ-CECC) for electronic components.

### Electrical Characteristics and Fields of Application

Basically the WIMA SMD series have the same electrical characteristics as the analogous through-hole WIMA capacitors. Compared to ceramic or tantalum

dielectrics WIMA SMD capacitors have a number of other outstanding qualities:

- favourable pulse rise time
- low ESR
- low dielectric absorption
- available in high voltage series
- large capacitance spectrum
- stand up to high mechanical stress
- good long-term stability

As regards technical performance as well as quality and reliability, the WIMA SMD series offer the possibility to cover nearly all applications of conventionally through-hole film capacitors with SMD components. Furthermore, the WIMA SMD series can now be used for all the demanding capacitor applications for which, in the past, the use of through-hole components was mandatory:

- measuring techniques
- oscillator circuits
- differentiating and integrating circuits
- A/D or D/A transformers
- sample and hold circuits
- automotive electronics

With the WIMA SMD programme available today, the major part of all plastic film capacitors can be replaced by WIMA SMD components. The field of application ranges from standard coupling capacitors to use in switch-mode power supplies as filter or charging capacitors with high voltage and capacitance values, as well as in telecommunications e.g. the well-known telephone capacitor 1µF/250VDC.

# Blister Tape Packaging and Packing Units of the WIMA SMD Capacitors



**Tape reel:**

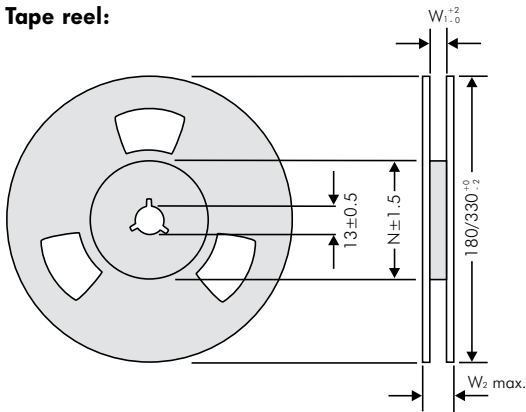

**Tape advance and return:**

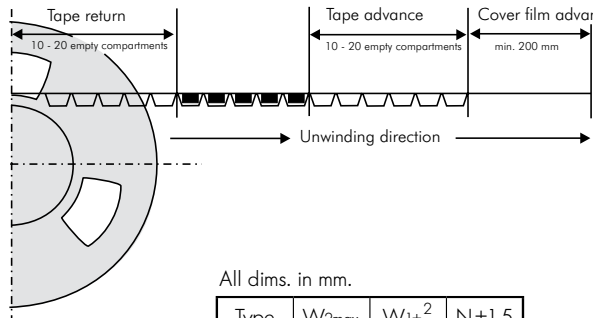

All dims. in mm.

Type	W <sub>2max</sub>	W <sub>1±0.2</sub>	N±1.5
1812	19	12.4	62
2220	19	12.4	62
2824	19	12.4	62
4030	22.4	16.4	60
5040	30.4	24.4	90
6054	30.4	24.4	90

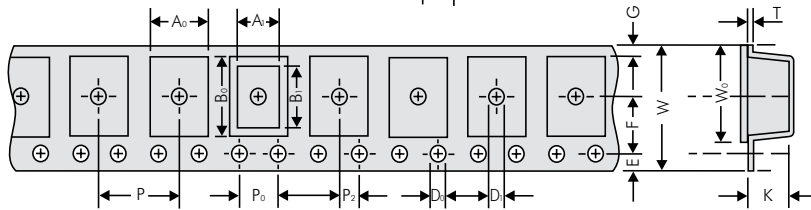

**Packing units**

Size Code 1812		A <sub>0</sub> ±0.1	A <sub>1</sub>	B <sub>0</sub> ±0.1	B <sub>1</sub>	D <sub>0</sub> +0.1 -0	D <sub>1</sub> +0.1 -0	P ±0.1	P <sub>0</sub> * ±0.1	P <sub>2</sub> ±0.05	E ±0.1	F ±0.05	G	W ±0.3	W <sub>0</sub> ±0.2	K ±0.1	T ±0.1
Box size	Code																
4.8x3.3x3	<b>KA</b>	3.55	3.3	5.1	4.8	ø1.5	ø1.5	8	4	2	1.75	5.5	2.2	12	9.5	3.4	0.3
4.8x3.3x4	<b>KB</b>	3.55	3.3	5.1	4.8	ø1.5	ø1.5	8	4	2	1.75	5.5	2.2	12	9.5	4.4	0.3

taped Reel	taped Reel	bulk	
180 mm ø	330 mm ø	Mini	Standard
700	2500	1000	3000
500	2000	1000	3000

Size Code 2220		A <sub>0</sub> ±0.1	A <sub>1</sub>	B <sub>0</sub> ±0.1	B <sub>1</sub>	D <sub>0</sub> +0.1 -0	D <sub>1</sub> +0.1 -0	P ±0.1	P <sub>0</sub> * ±0.1	P <sub>2</sub> ±0.05	E ±0.1	F ±0.05	G	W ±0.3	W <sub>0</sub> ±0.2	K ±0.1	T ±0.1
Box size	Code																
5.7x5.1x3.5	<b>QA</b>	6.3	5.7	5.6	5.1	ø1.5	ø1.5	8	4	2	1.75	5.5	1.95	12	9.5	3.7	0.3
5.7x5.1x4.5	<b>QB</b>	6.3	5.7	5.6	5.1	ø1.5	ø1.5	8	4	2	1.75	5.5	1.95	12	9.5	4.7	0.3

taped Reel	taped Reel	bulk	
180 mm ø	330 mm ø	Mini	Standard
500	1800	1000	3000
400	1500	1000	3000

Size Code 2824		A <sub>0</sub> ±0.1	A <sub>1</sub>	B <sub>0</sub> ±0.1	B <sub>1</sub>	D <sub>0</sub> +0.1 -0	D <sub>1</sub> +0.1 -0	P ±0.1	P <sub>0</sub> * ±0.1	P <sub>2</sub> ±0.05	E ±0.1	F ±0.05	G	W ±0.3	W <sub>0</sub> ±0.2	K ±0.1	T ±0.1
Box size	Code																
7.2x6.1x3	<b>TA</b>	6.6	6.1	7.7	7.2	ø1.5	ø1.5	12	4	2	1.75	5.5	0.9	12	9.5	3.4	0.3
7.2x6.1x5	<b>TB</b>	6.6	6.1	7.7	7.2	ø1.5	ø1.5	12	4	2	1.75	5.5	0.9	12	9.5	5.4	0.4

taped Reel	bulk	
330 mm ø	Mini	Standard
1500	500	2000
750	500	2000

	Code	A <sub>0</sub> ±0.1	A <sub>1</sub>	B <sub>0</sub> ±0.1	B <sub>1</sub>	D <sub>0</sub> +0.1 -0	D <sub>1</sub> +0.1 -0	P ±0.1	P <sub>0</sub> * ±0.1	P <sub>2</sub> ±0.05	E ±0.1	F ±0.05	G	W ±0.3	W <sub>0</sub> ±0.2	K ±0.1	T ±0.1
<b>Size Code 4030</b>	<b>VA</b>	10.7	10.2	8.1	9.1	ø1.5	ø1.5	16	4	2	1.75	7.5	1.9	16	13.3	5.5	0.3
<b>Size Code 5040</b>	<b>XA</b>	13.5	12.7	11	11.5	ø1.5	ø1.5	16	4	2	1.75	11.5	4.7	24	21.3	6.5	0.3
<b>Size Code 6054</b>	<b>YA</b>	17.0	16.5	15.6	15.0	ø1.5	ø1.5	20	4	2	1.75	11.5	2.95	24	21.3	7.5	0.3

taped Reel	bulk	
330 mm ø	Mini	Standard
775	500	2000
600	200	1000
450	100	500

\* cumulative after 10 steps ± 0.2 mm max.  
Samples and pre-production needs on request or 1 Reel minimum.

**Part number codes for SMD packing**

W (Blister)	ø in mm	Code
12	180	<b>P</b>
12	330	<b>Q</b>
16	330	<b>R</b>
24	330	<b>T</b>

Bulk Standard	<b>S</b>
---------------	----------



# WIMA Part Number System

A WIMA part number consists of 18 digits and is composed as follows:

- Field 1 - 4: Type description
- Field 5 - 6: Rated voltage
- Field 7 - 10: Capacitance
- Field 11 - 12: Size and PCM
- Field 13 - 14: Version code (e.g. Snubber versions)
- Field 15: Capacitance tolerance
- Field 16: Packing
- Field 17 - 18: Pin length (untaped)

1	2	3	4	5	6	7	8	9	10	11	12	13	14	15	16	17	18
M	K	S	2	C	0	2	1	0	0	1	A	0	0	M	S	S	D
MKS 2				63 VDC		0.01 µF			2.5x6.5x7.2		-		20%	bulk	6-2		

<p><b>Type description:</b></p> <p>SMD-PET = SMDT          SMD-PPS = SMDI          FKP 02 = FKP0          MKS 02 = MKS0          FKS 2 = FKS2          FKP 2 = FKP2          MKS 2 = MKS2          MKP 2 = MKP2          FKS 3 = FKS3          FKP 3 = FKP3          MKS 4 = MKS4          MKP 4 = MKP4          MKP 10 = MKP1          FKP 4 = FKP4          FKP 1 = FKP1          MKP-X2 = MKX2          MKP-X2 R = MKXR          MKP-Y2 = MKY2          MP 3-X2 = MPX2          MP 3-X1 = MPX1          MP 3-Y2 = MPY2          MP 3R-Y2 = MPRY          Snubber MKP = SNMP          Snubber FKP = SNFP          GTO MKP = GTOM          DC-LINK MKP 3 = DCP3          DC-LINK MKP 4 = DCP4          DC-LINK MKP 4S = DCPS          DC-LINK MKP 5 = DCP5          DC-LINK MKP 6 = DCP6          DC-LINK HC = DCH_          DC-LINK HY = DCHY          SuperCap S = SCSS          SuperCap H = SCSH          SuperCap M = SCM_</p>	<p><b>Rated voltage:</b></p> <p>2.7 VDC = A1          12 VDC = AN          16 VDC = A0          32 VDC = AH          48 VDC = AQ          50 VDC = B0          56 VDC = B1          63 VDC = C0          64 VDC = CA          100 VDC = D0          125 VDC = DA          250 VDC = F0          400 VDC = G0          450 VDC = H0          600 VDC = I0          630 VDC = J0          700 VDC = K0          800 VDC = L0          850 VDC = M0          900 VDC = N0          1000 VDC = O1          1100 VDC = P0          1200 VDC = Q0          1250 VDC = R0          1500 VDC = S0          1600 VDC = T0          2000 VDC = U0          2500 VDC = V0          3000 VDC = W0          4000 VDC = X0          6000 VDC = Y0          250 VAC = 0W          275 VAC = 1W          300 VAC = 2W          400 VAC = 3W          440 VAC = 4W          500 VAC = 5W</p>	<p><b>Capacitance:</b></p> <p>22 pF = 0022          47 pF = 0047          100 pF = 0100          150 pF = 0150          220 pF = 0220          330 pF = 0330          470 pF = 0470          680 pF = 0680          1000 pF = 1100          1500 pF = 1150          2200 pF = 1220          3300 pF = 1330          4700 pF = 1470          6800 pF = 1680          0.01 µF = 2100          0.022 µF = 2220          0.047 µF = 2470          0.1 µF = 3100          0.22 µF = 3220          0.47 µF = 3470          1 µF = 4100          2.2 µF = 4220          4.7 µF = 4470          10 µF = 5100          22 µF = 5220          47 µF = 5470          100 µF = 6100          220 µF = 6220          1 F = A010          2.5 F = A025          50 F = A500          100 F = B100          125 F = B125          500 F = B500          1200 F = C120          ...</p>	<p><b>Size:</b></p> <p>4.8x3.3x3 Size 1812 = KA          4.8x3.3x4 Size 1812 = KB          5.7x5.1x3.5 Size 2220 = QA          5.7x5.1x4.5 Size 2220 = QB          7.2x6.1x3 Size 2824 = TA          7.2x6.1x5 Size 2824 = TB          10.2x7.6x5 Size 4030 = VA          12.7x10.2x6 Size 5040 = XA          15.3x13.7x7 Size 6054 = YA          2.5x7x4.6 PCM 2.5 = 0B          3x7.5x4.6 PCM 2.5 = 0C          2.5x6.5x7.2 PCM 5 = 1A          3x7.5x7.2 PCM 5 = 1B          2.5x7x10 PCM 7.5 = 2A          3x8.5x10 PCM 7.5 = 2B          3x9x13 PCM 10 = 3A          4x9x13 PCM 10 = 3C          5x11x18 PCM 15 = 4B          6x12.5x18 PCM 15 = 4C          5x14x26.5 PCM 22.5 = 5A          6x15x26.5 PCM 22.5 = 5B          9x19x31.5 PCM 27.5 = 6A          11x21x31.5 PCM 27.5 = 6B          9x19x41.5 PCM 37.5 = 7A          11x22x41.5 PCM 37.5 = 7B          94x49x182 DCH_ = H0          94x77x182 DCH_ = H1          ...</p> <p><b>Version code:</b></p> <p>Standard = 00          Version A1 = 1A          Version A1.1.1 = 1B          Version A2 = 2A          ...</p>	<p><b>Tolerance:</b></p> <p>20% = M          10% = K          5% = J          2.5% = H          1% = E          ...</p> <p><b>Packing:</b></p> <p>AMMO H16.5 340x340 = A          AMMO H16.5 490x370 = B          AMMO H18.5 340x340 = C          AMMO H18.5 490x370 = D          REEL H16.5 360 = F          REEL H16.5 500 = H          REEL H18.5 360 = I          REEL H18.5 500 = J          ROLL H16.5 = N          ROLL H18.5 = O          BLISTER W12 180 = P          BLISTER W12 330 = Q          BLISTER W16 330 = R          BLISTER W24 330 = T          Bulk/TPS Standard = S          ...</p> <p><b>Pin length (untaped)</b></p> <p>3.5 ±0.5 = C9          6-2 = SD          16 ±1 = P1          ...</p>
--	---	---	--	---

The data on this page is not complete and serves only to explain the part number system. Part number information is listed on the pages of the respective WIMA range.





Компания «ЭлектроПласт» предлагает заключение долгосрочных отношений при поставках импортных электронных компонентов на взаимовыгодных условиях!

Наши преимущества:

- Оперативные поставки широкого спектра электронных компонентов отечественного и импортного производства напрямую от производителей и с крупнейших мировых складов;
- Поставка более 17-ти миллионов наименований электронных компонентов;
- Поставка сложных, дефицитных, либо снятых с производства позиций;
- Оперативные сроки поставки под заказ (от 5 рабочих дней);
- Экспресс доставка в любую точку России;
- Техническая поддержка проекта, помощь в подборе аналогов, поставка прототипов;
- Система менеджмента качества сертифицирована по Международному стандарту ISO 9001;
- Лицензия ФСБ на осуществление работ с использованием сведений, составляющих государственную тайну;
- Поставка специализированных компонентов (Xilinx, Altera, Analog Devices, Intersil, Interpoint, Microsemi, Aeroflex, Peregrine, Syfer, Eurofarad, Texas Instrument, Miteq, Cobham, E2V, MA-COM, Hittite, Mini-Circuits, General Dynamics и др.);

Помимо этого, одним из направлений компании «ЭлектроПласт» является направление «Источники питания». Мы предлагаем Вам помощь Конструкторского отдела:

- Подбор оптимального решения, техническое обоснование при выборе компонента;
- Подбор аналогов;
- Консультации по применению компонента;
- Поставка образцов и прототипов;
- Техническая поддержка проекта;
- Защита от снятия компонента с производства.



#### Как с нами связаться

**Телефон:** 8 (812) 309 58 32 (многоканальный)

**Факс:** 8 (812) 320-02-42

**Электронная почта:** [org@eplast1.ru](mailto:org@eplast1.ru)

**Адрес:** 198099, г. Санкт-Петербург, ул. Калинина, дом 2, корпус 4, литера А.