

RoHS

Sxx12x Series

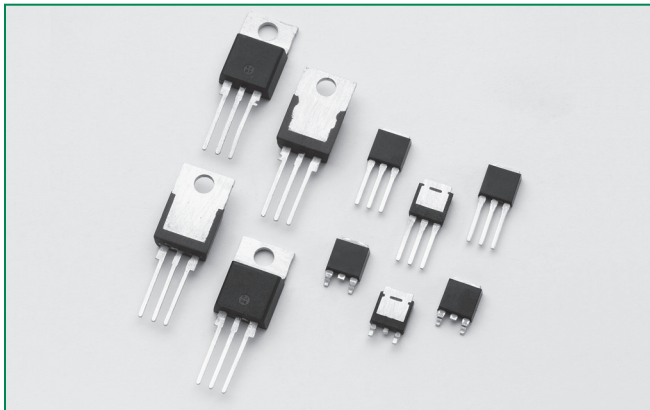

Description

Excellent unidirectional switches for phase control applications such as heating and motor speed controls. Standard phase control SCRs are triggered with few milliamperes of current at less than 1.5V potential.

Features & Benefits

- RoHS compliant
- Glass – passivated junctions
- Voltage capability up to 1000 V
- Surge capability up to 120 A

Applications

Typical applications are capacitive discharge systems for strobe lights, nailers, staplers and gas engine ignition. Also controls for power tools, home/brown goods and white goods appliances.

Main Features

Symbol	Value	Unit
$I_{T(RMS)}$	12	A
V_{DRM}/V_{RRM}	400 to 1000	V
I_{GT}	20	mA

Schematic Symbol

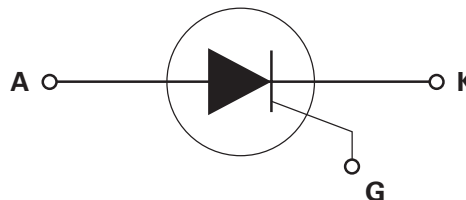

Absolute Maximum Ratings

Symbol	Parameter	Test Conditions	Value	Unit
$I_{T(RMS)}$	RMS on-state current	Sxx12R Sxx12D Sxx12V $T_C = 105^\circ\text{C}$	12	A
$I_{T(AV)}$	Average on-state current	Sxx12R Sxx12D Sxx12V $T_C = 105^\circ\text{C}$	7.6	A
I_{TSM}	Peak non-repetitive surge current	single half cycle; $f = 50\text{Hz}$; $T_J (\text{initial}) = 25^\circ\text{C}$	100	A
		single half cycle; $f = 60\text{Hz}$; $T_J (\text{initial}) = 25^\circ\text{C}$	120	
I^2t	I^2t Value for fusing	$t_p = 8.3 \text{ms}$	60	A^2s
di/dt	Critical rate of rise of on-state current	$f = 60\text{Hz}$; $T_J = 125^\circ\text{C}$	100	$\text{A}/\mu\text{s}$
I_{GM}	Peak gate current	$T_J = 125^\circ\text{C}$	2	A
$P_{G(AV)}$	Average gate power dissipation	$T_J = 125^\circ\text{C}$	0.5	W
T_{stg}	Storage temperature range		-40 to 150	$^\circ\text{C}$
T_J	Operating junction temperature range		-40 to 125	

Note: xx = voltage

Electrical Characteristics (T_J = 25°C, unless otherwise specified)

Symbol	Test Conditions			Value	Unit
I _{GT}	V _D = 12V R _L = 60 Ω		MAX.	20	mA
V _{GT}			MIN.	1	
				MAX.	1.5
dv/dt	V _D = V _{DRM} ; gate open; T _J = 100°C	400V	MIN.	350	V/μs
		600V		300	
		800V		250	
		1000V		100	
	V _D = V _{DRM} ; gate open; T _J = 125°C	400V		250	
		600V		225	
	800V	200			
V _{GD}	V _D = V _{DRM} R _L = 3.3 kΩ T _J = 125°C		MIN.	0.2	V
I _H	I _T = 200mA (initial)		MAX.	40	mA
t _q	I _T = 2A; t _p = 50μs; dv/dt = 5V/μs; di/dt = 30A/μs		MAX.	35	μs
t _{gt}	I _G = 2 x I _{GT} PW = 15μs I _T = 20A		TYP.	2	μs

Static Characteristics

Symbol	Test Conditions			Value	Unit
V _{TM}	I _T = 24A; t _p = 380 μs		MAX.	1.6	V
I _{DRM} / I _{RRM}	V _{DRM} = V _{RRM}	T _J = 25°C	MAX.	400 – 600V	10
				800 – 1000V	20
		T _J = 100°C		400 – 800V	500
				1000V	3000
	T _J = 125°C	400 – 800V	1000	μA	

Thermal Resistances

Symbol	Parameter		Value	Unit
R _{θ(J-C)}	Junction to case (AC)	Sxx12R	1.5	°C/W
		Sxx12V	1.6	
		Sxx12D	1.4	
R _{θ(J-A)}	Junction to ambient	Sxx12R	40	°C/W
		Sxx12V	70	

Note: xx = voltage

Figure 1: Normalized DC Gate Trigger Current vs. Junction Temperature

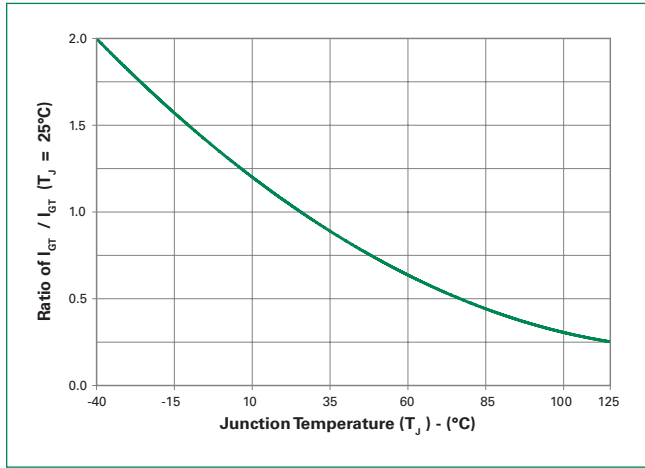

Figure 2: Normalized DC Gate Trigger Voltage vs. Junction Temperature

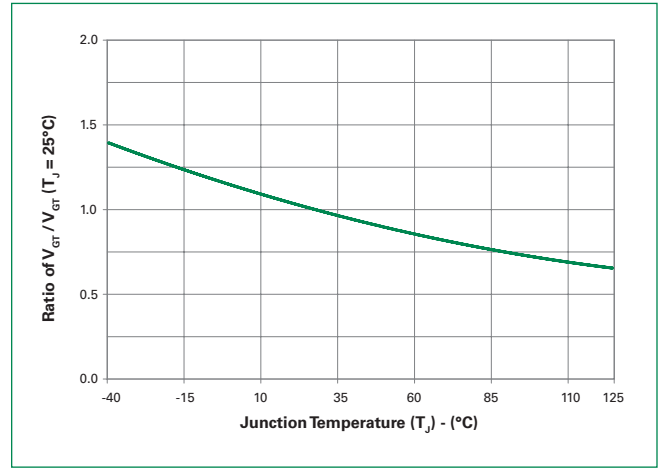

Figure 3: Normalized DC Holding Current vs. Junction Temperature

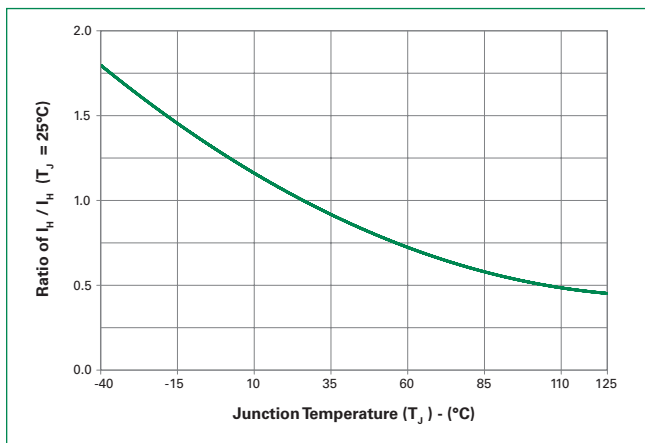

Figure 4: On-State Current vs. On-State Voltage (Typical)

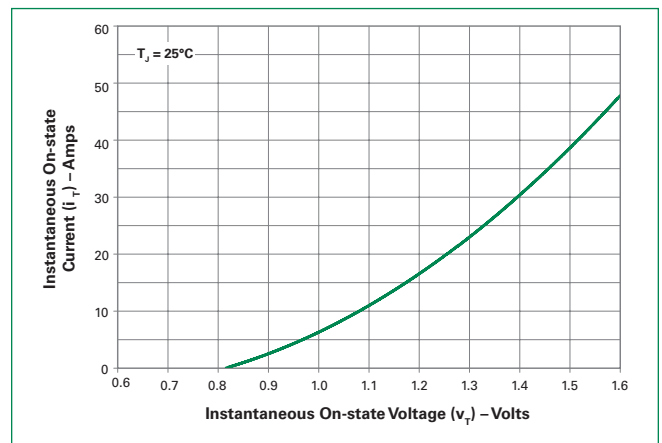

Figure 5: Power Dissipation (Typical) vs. RMS On-State Current

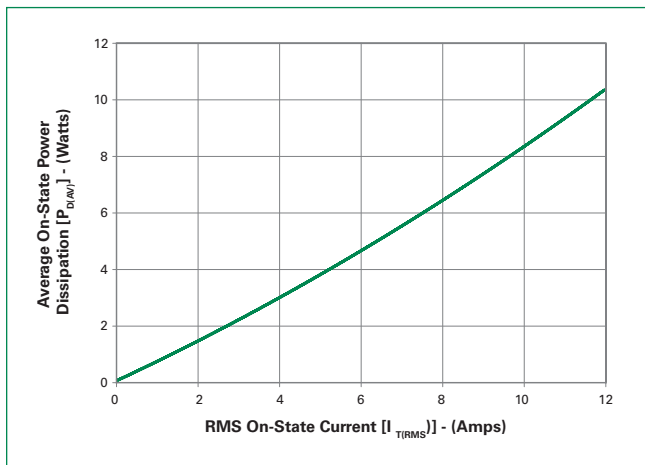

Figure 6: Maximum Allowable Case Temperature vs. RMS On-State Current

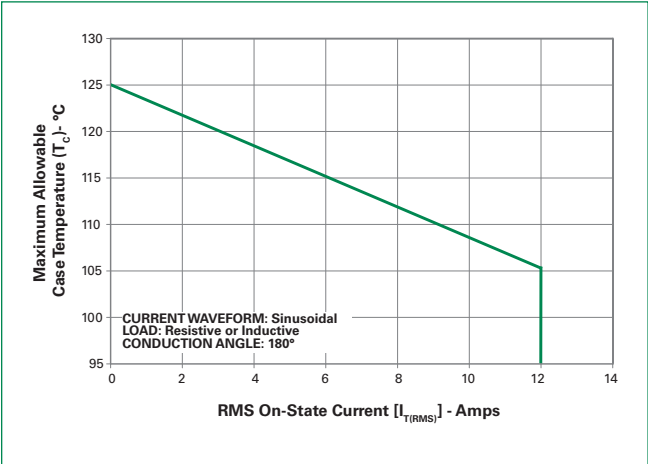

Figure 7: Maximum Allowable Case Temperature vs. Average On-State Current

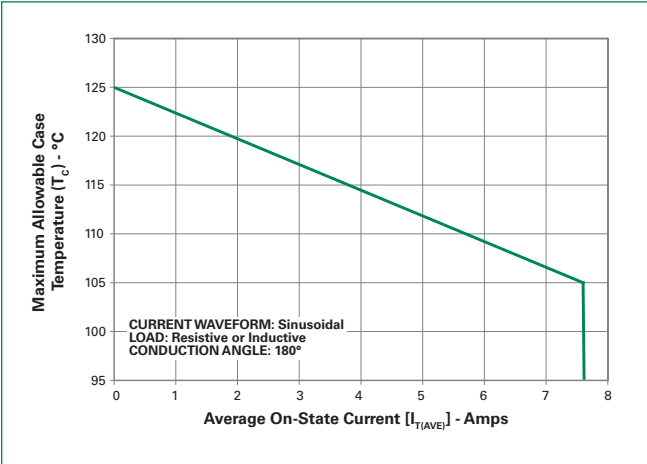
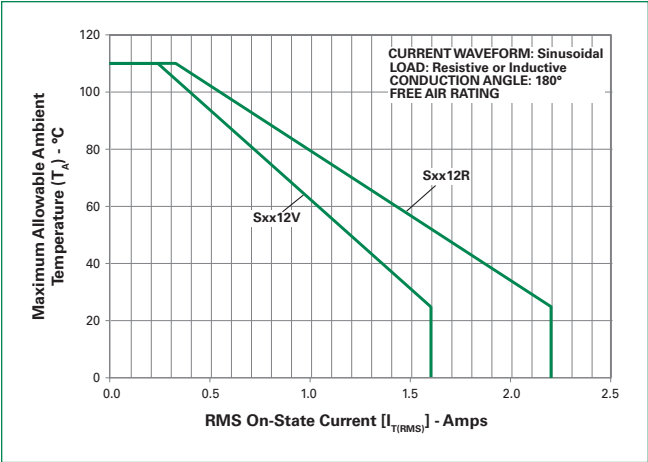

Figure 8: Maximum Allowable Ambient Temperature vs. RMS On-State Current



Note: xx = voltage

Figure 9: Maximum Allowable Ambient Temperature vs. Average On-State Current

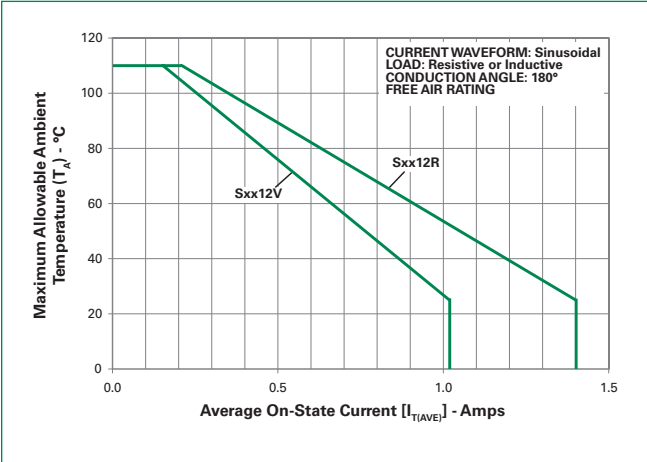

Figure 10: Peak Capacitor Discharge Current

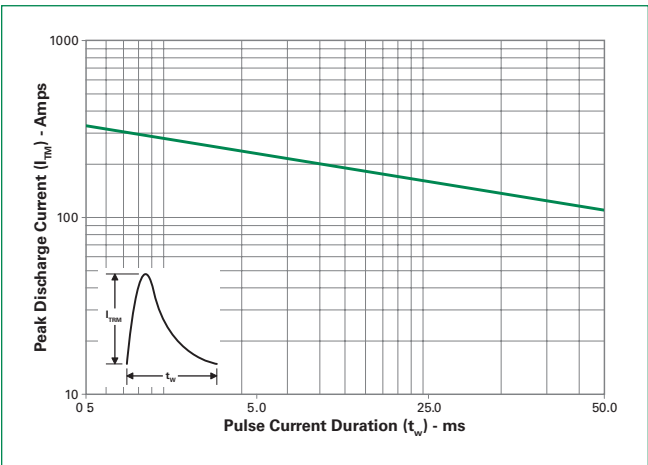

Figure 11: Peak Capacitor Discharge Current Derating

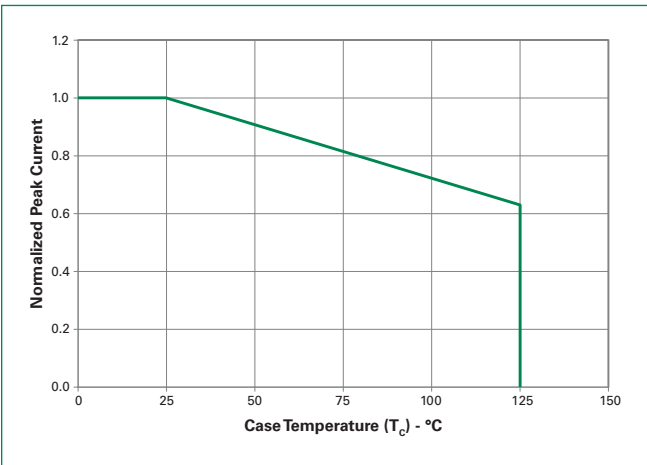
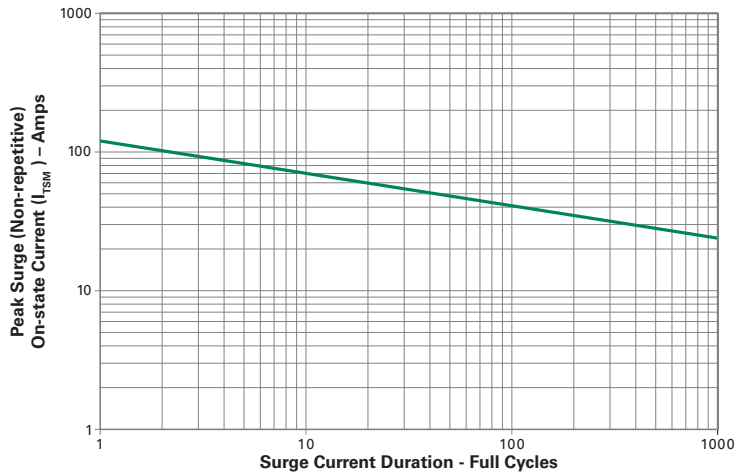

Figure 12: Surge Peak On-State Current vs. Number of Cycles



SUPPLY FREQUENCY: 60 Hz Sinusoidal
LOAD: Resistive
RMS On-State Current: [I_{T(RMS)}]: Maximum Rated Value at Specified Case Temperature

Notes:

1. Gate control may be lost during and immediately following surge current interval.
2. Overload may not be repeated until junction temperature has returned to steady-state rated value.

Soldering Parameters

Reflow Condition	Pb – Free assembly	
Pre Heat	- Temperature Min (T _{s(min)})	150°C
	- Temperature Max (T _{s(max)})	200°C
	- Time (min to max) (t _s)	60 – 180 secs
Average ramp up rate (Liquidus Temp) (T _L) to peak	5°C/second max	
T _{S(max)} to T _L - Ramp-up Rate	5°C/second max	
Reflow	- Temperature (T _L) (Liquidus)	217°C
	- Temperature (t _l)	60 – 150 seconds
Peak Temperature (T _p)	260 ^{+0/-5} °C	
Time within 5°C of actual peak Temperature (t _p)	20 – 40 seconds	
Ramp-down Rate	5°C/second max	
Time 25°C to peak Temperature (T _p)	8 minutes Max.	
Do not exceed	280°C	

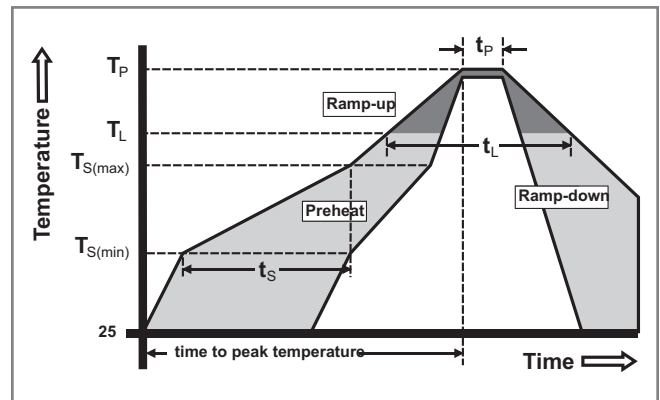

Physical Specifications

Terminal Finish	100% Matte Tin-plated
Body Material	UL recognized epoxy meeting flammability classification 94V-0
Lead Material	Copper Alloy

Design Considerations

Careful selection of the correct device for the application's operating parameters and environment will go a long way toward extending the operating life of the Thyristor. Good design practice should limit the maximum continuous current through the main terminals to 75% of the device rating. Other ways to ensure long life for a power discrete semiconductor are proper heat sinking and selection of voltage ratings for worst case conditions. Overheating, overvoltage (including dv/dt), and surge currents are the main killers of semiconductors. Correct mounting, soldering, and forming of the leads also help protect against component damage.

Environmental Specifications

Test	Specifications and Conditions
AC Blocking	MIL-STD-750, M-1040, Cond A Applied Peak AC voltage @ 125°C for 1008 hours
Temperature Cycling	MIL-STD-750, M-1051, 100 cycles; -40°C to +150°C; 15-min dwell-time
Temperature/Humidity	EIA / JEDEC, JESD22-A101 1008 hours; 320V - DC: 85°C; 85% rel humidity
High Temp Storage	MIL-STD-750, M-1031, 1008 hours; 150°C
Low-Temp Storage	1008 hours; -40°C
Thermal Shock	MIL-STD-750, M-1056 10 cycles; 0°C to 100°C; 5-min dwell-time at each temperature; 10 sec (max) transfer time between temperature
Autoclave	EIA / JEDEC, JESD22-A102 168 hours (121°C at 2 ATM) and 100% R/H
Resistance to Solder Heat	MIL-STD-750 Method 2031
Solderability	ANSI/J-STD-002, category 3, Test A
Lead Bend	MIL-STD-750, M-2036 Cond E

Dimensions — TO-220AB (R-Package) — Non-Isolated Mounting Tab Common with Center Lead

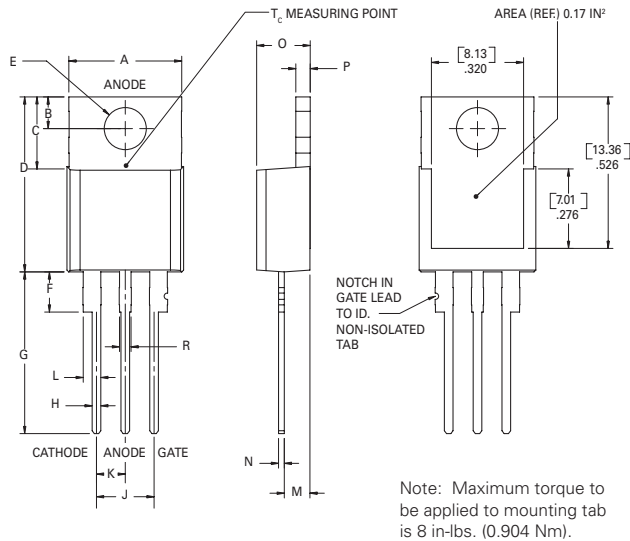

Dimension	Inches		Millimeters	
	Min	Max	Min	Max
A	0.380	0.420	9.65	10.67
B	0.105	0.115	2.67	2.92
C	0.230	0.250	5.84	6.35
D	0.590	0.620	14.99	15.75
E	0.142	0.147	3.61	3.73
F	0.110	0.130	2.79	3.30
G	0.540	0.575	13.72	14.61
H	0.025	0.035	0.64	0.89
J	0.195	0.205	4.95	5.21
K	0.095	0.105	2.41	2.67
L	0.060	0.075	1.52	1.91
M	0.085	0.095	2.16	2.41
N	0.018	0.024	0.46	0.61
O	0.178	0.188	4.52	4.78
P	0.045	0.060	1.14	1.52
R	0.038	0.048	0.97	1.22

Dimensions — TO-251AA (V/I-Package) — V/I-PAK Through Hole

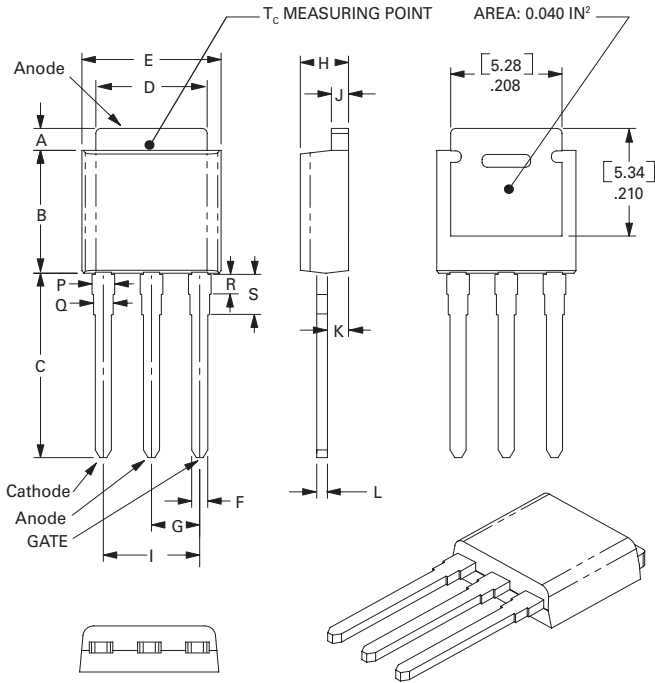

Dimension	Inches			Millimeters		
	Min	Typ	Max	Min	Typ	Max
A	0.040	0.044	0.050	1.02	1.11	1.27
B	0.235	0.242	0.245	5.97	6.15	6.22
C	0.350	0.361	0.375	8.89	9.18	9.53
D	0.205	0.208	0.213	5.21	5.29	5.41
E	0.255	0.262	0.265	6.48	6.66	6.73
F	0.027	0.031	0.033	0.69	0.80	0.84
G	0.087	0.090	0.093	2.21	2.28	2.36
H	0.085	0.092	0.095	2.16	2.34	2.41
I	0.176	0.180	0.184	4.47	4.57	4.67
J	0.018	0.020	0.023	0.46	0.51	0.58
K	0.038	0.040	0.044	0.97	1.01	1.12
L	0.018	0.020	0.023	0.46	0.52	0.58
P	0.042	0.047	0.052	1.06	1.20	1.32
Q	0.034	0.039	0.044	0.86	1.00	1.11
R	0.034	0.039	0.044	0.86	1.00	1.11
S	0.074	0.079	0.084	1.86	2.00	2.11

Dimensions — TO-252AA (D-Package) — D-PAK Surface Mount

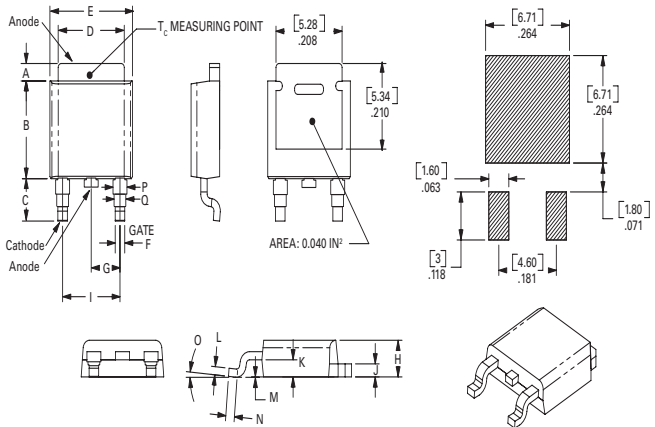

Dimension	Inches			Millimeters		
	Min	Typ	Max	Min	Typ	Max
A	0.040	0.043	0.050	1.02	1.09	1.27
B	0.235	0.243	0.245	5.97	6.16	6.22
C	0.106	0.108	0.113	2.69	2.74	2.87
D	0.205	0.208	0.213	5.21	5.29	5.41
E	0.255	0.262	0.265	6.48	6.65	6.73
F	0.027	0.031	0.033	0.69	0.80	0.84
G	0.087	0.090	0.093	2.21	2.28	2.36
H	0.085	0.092	0.095	2.16	2.33	2.41
I	0.176	0.179	0.184	4.47	4.55	4.67
J	0.018	0.020	0.023	0.46	0.51	0.58
K	0.038	0.040	0.044	0.97	1.02	1.12
L	0.018	0.020	0.023	0.46	0.51	0.58
M	0.000	0.000	0.004	0.00	0.00	0.10
N	0.021	0.026	0.027	0.53	0.67	0.69
O	0°	0°	5°	0°	0°	5°
P	0.042	0.047	0.052	1.06	1.20	1.32
Q	0.034	0.039	0.044	0.86	1.00	1.11

Product Selector

Part Number	Voltage				Gate Sensitivity	Type	Package
	400V	600V	800V	1000V			
Sxx12R	X	X	X	X	20mA	Sensitive SCR	TO-220R
Sxx12V	X	X	X	X	20mA	Standard SCR	TO-251
Sxx12D	X	X	X	X	20mA	Standard SCR	TO-252

Note: xx = voltage

Packing Options

Part Number	Marking	Weight	Packing Mode	Base Quantity
Sxx12R	Sxx12R	2.2 g	Bulk	500
Sxx12RTP	Sxx12R	2.2 g	Tube	500 (50 per tube)
Sxx12DTP	Sxx12D	0.3 g	Tube	750 (75 per tube)
Sxx12DRP	Sxx12D	0.3 g	Embossed Carrier	2500
Sxx12VTP	Sxx12V	0.4 g	Tube	750 (75 per tube)

Note: xx = Voltage

TO-252 Embossed Carrier Reel Pack (RP) Specifications

Meets all EIA-481-2 Standards

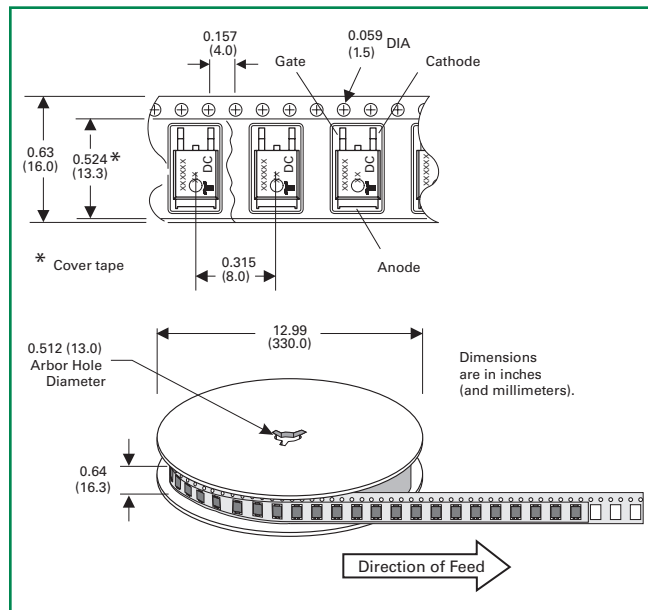

Part Marking System

TO-220 AB – (R Package)

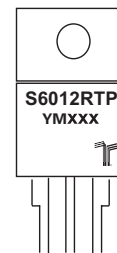

TO-251AA – (V Package)

TO-252AA – (D Package)

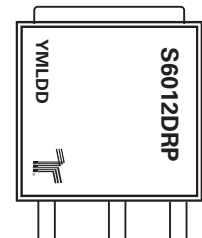

Part Numbering System

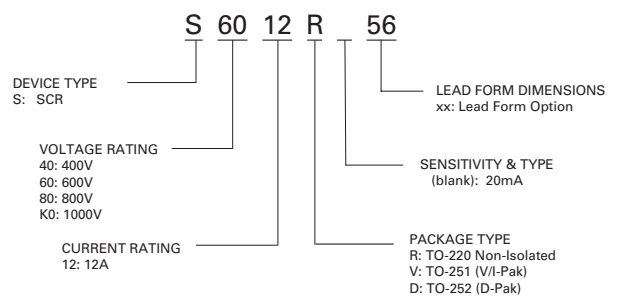



Компания «ЭлектроПласт» предлагает заключение долгосрочных отношений при поставках импортных электронных компонентов на взаимовыгодных условиях!

Наши преимущества:

- Оперативные поставки широкого спектра электронных компонентов отечественного и импортного производства напрямую от производителей и с крупнейших мировых складов;
- Поставка более 17-ти миллионов наименований электронных компонентов;
- Поставка сложных, дефицитных, либо снятых с производства позиций;
- Оперативные сроки поставки под заказ (от 5 рабочих дней);
- Экспресс доставка в любую точку России;
- Техническая поддержка проекта, помощь в подборе аналогов, поставка прототипов;
- Система менеджмента качества сертифицирована по Международному стандарту ISO 9001;
- Лицензия ФСБ на осуществление работ с использованием сведений, составляющих государственную тайну;
- Поставка специализированных компонентов (Xilinx, Altera, Analog Devices, Intersil, Interpoint, Microsemi, Aeroflex, Peregrine, Syfer, Eurofarad, Texas Instrument, Miteq, Cobham, E2V, MA-COM, Hittite, Mini-Circuits, General Dynamics и др.);

Помимо этого, одним из направлений компании «ЭлектроПласт» является направление «Источники питания». Мы предлагаем Вам помощь Конструкторского отдела:

- Подбор оптимального решения, техническое обоснование при выборе компонента;
- Подбор аналогов;
- Консультации по применению компонента;
- Поставка образцов и прототипов;
- Техническая поддержка проекта;
- Защита от снятия компонента с производства.



Как с нами связаться

Телефон: 8 (812) 309 58 32 (многоканальный)

Факс: 8 (812) 320-02-42

Электронная почта: org@eplast1.ru

Адрес: 198099, г. Санкт-Петербург, ул. Калинина, дом 2, корпус 4, литера А.