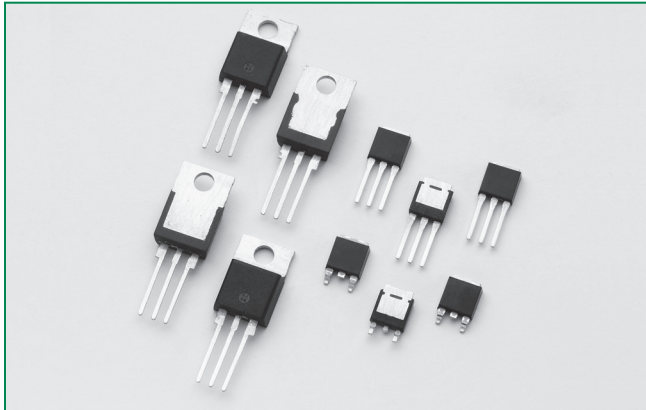


**RoHS** **Sxx12x Series**



**Description**

Excellent unidirectional switches for phase control applications such as heating and motor speed controls. Standard phase control SCRs are triggered with few milliamperes of current at less than 1.5V potential.

**Features & Benefits**

- RoHS compliant
- Glass – passivated junctions
- Voltage capability up to 1000 V
- Surge capability up to 120 A

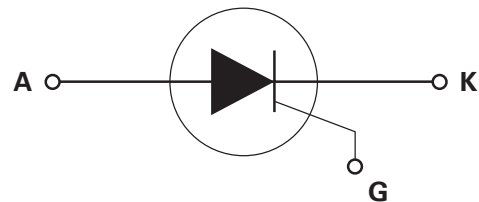
**Applications**

Typical applications are capacitive discharge systems for strobe lights, nailers, staplers and gas engine ignition. Also controls for power tools, home/brown goods and white goods appliances.

**Main Features**

Symbol	Value	Unit
$I_{T(RMS)}$	12	A
$V_{DRM}/V_{RRM}$	400 to 1000	V
$I_{GT}$	20	mA

**Schematic Symbol**



**Absolute Maximum Ratings**

Symbol	Parameter	Test Conditions		Value	Unit
$I_{T(RMS)}$	RMS on-state current	Sxx12R Sxx12D Sxx12V	$T_c = 105^\circ\text{C}$	12	A
$I_{T(AV)}$	Average on-state current	Sxx12R Sxx12D Sxx12V	$T_c = 105^\circ\text{C}$	7.6	A
$I_{TSM}$	Peak non-repetitive surge current	single half cycle; $f = 50\text{Hz}$ ; $T_J(\text{initial}) = 25^\circ\text{C}$		100	A
		single half cycle; $f = 60\text{Hz}$ ; $T_J(\text{initial}) = 25^\circ\text{C}$		120	
$I^2t$	$I^2t$ Value for fusing	$t_p = 8.3 \text{ ms}$		60	$\text{A}^2\text{s}$
$di/dt$	Critical rate of rise of on-state current	$f = 60\text{Hz}$ ; $T_J = 125^\circ\text{C}$		100	$\text{A}/\mu\text{s}$
$I_{GM}$	Peak gate current	$T_J = 125^\circ\text{C}$		2	A
$P_{G(AV)}$	Average gate power dissipation	$T_J = 125^\circ\text{C}$		0.5	W
$T_{stg}$	Storage temperature range			-40 to 150	$^\circ\text{C}$
$T_J$	Operating junction temperature range			-40 to 125	

Note: xx = voltage

**Electrical Characteristics (T<sub>J</sub> = 25°C, unless otherwise specified)**

Symbol	Test Conditions		Value	Unit	
I <sub>GT</sub>	V <sub>D</sub> = 12V R <sub>L</sub> = 60 Ω		MAX.	20	mA
V <sub>GT</sub>			MIN.	1	
				MAX.	1.5
dv/dt	V <sub>D</sub> = V <sub>DRM</sub> ; gate open; T <sub>J</sub> = 100°C	400V	MIN.	350	V/μs
		600V		300	
		800V		250	
		1000V		100	
	V <sub>D</sub> = V <sub>DRM</sub> ; gate open; T <sub>J</sub> = 125°C	400V		250	
		600V		225	
	800V	200			
V <sub>GD</sub>	V <sub>D</sub> = V <sub>DRM</sub> R <sub>L</sub> = 3.3 kΩ T <sub>J</sub> = 125°C		MIN.	0.2	V
I <sub>H</sub>	I <sub>T</sub> = 200mA (initial)		MAX.	40	mA
t <sub>q</sub>	I <sub>T</sub> = 2A; t <sub>p</sub> = 50μs; dv/dt = 5V/μs; di/dt = 30A/μs		MAX.	35	μs
t <sub>gt</sub>	I <sub>G</sub> = 2 x I <sub>GT</sub> PW = 15μs I <sub>T</sub> = 20A		TYP.	2	μs

**Static Characteristics**

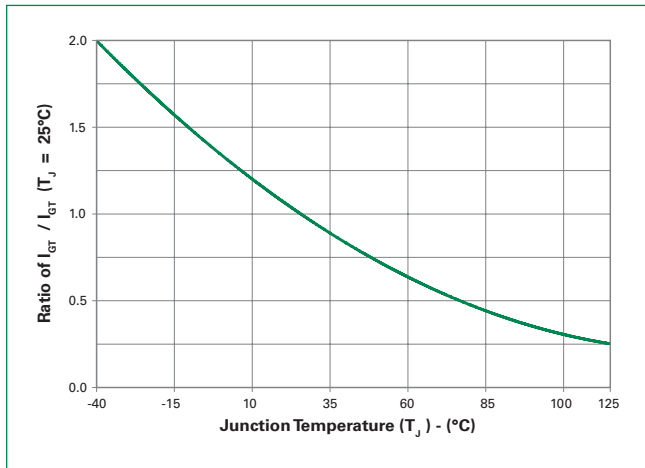
Symbol	Test Conditions		Value	Unit		
V <sub>TM</sub>	I <sub>T</sub> = 24A; t <sub>p</sub> = 380 μs		MAX.	1.6	V	
I <sub>DRM</sub> / I <sub>RRM</sub>	V <sub>DRM</sub> = V <sub>RRM</sub>	T <sub>J</sub> = 25°C	400 – 600V	MAX.	10	μA
			800 – 1000V		20	
		T <sub>J</sub> = 100°C	400 – 800V		500	
			1000V		3000	
		T <sub>J</sub> = 125°C	400 – 800V	1000		

**Thermal Resistances**

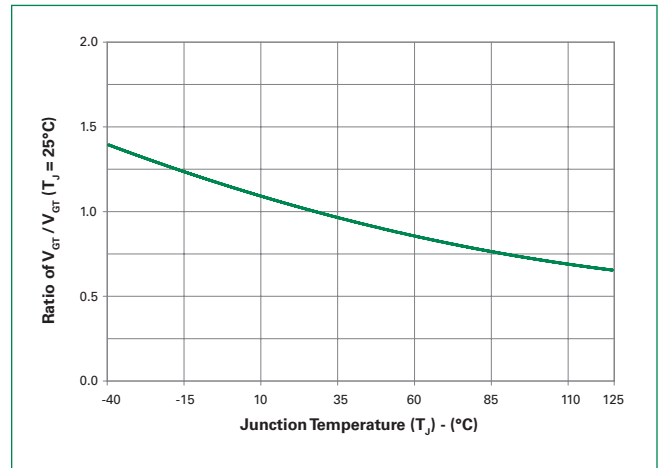
Symbol	Parameter	Value	Unit	
R <sub>θ(J-C)</sub>	Junction to case (AC)	Sxx12R	1.5	°C/W
		Sxx12V	1.6	
		Sxx12D	1.4	
R <sub>θ(J-A)</sub>	Junction to ambient	Sxx12R	40	°C/W
		Sxx12V	70	

Note: xx = voltage

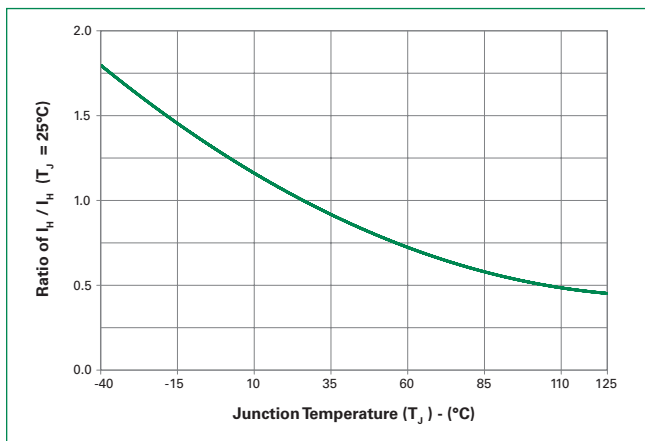
**Figure 1: Normalized DC Gate Trigger Current vs. Junction Temperature**



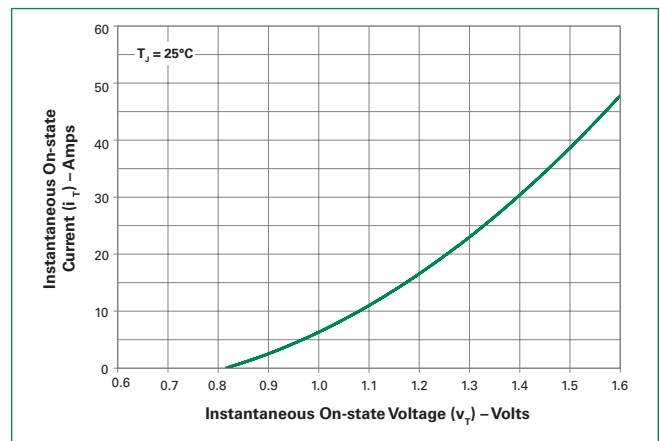
**Figure 2: Normalized DC Gate Trigger Voltage vs. Junction Temperature**



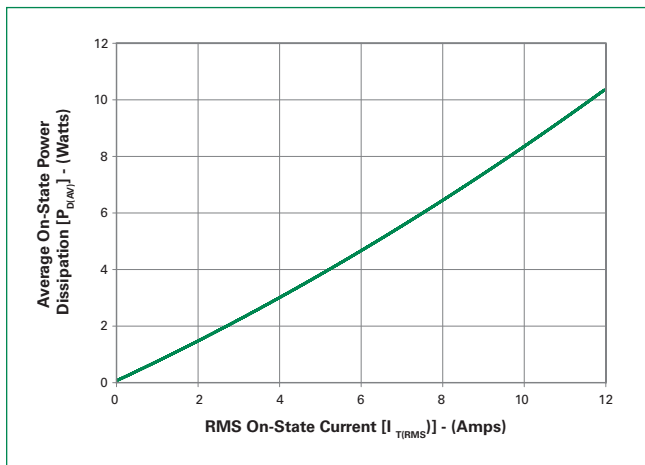
**Figure 3: Normalized DC Holding Current vs. Junction Temperature**



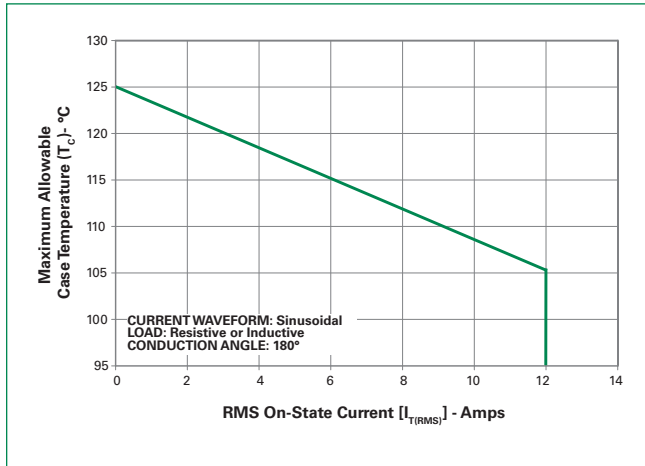
**Figure 4: On-State Current vs. On-State Voltage (Typical)**



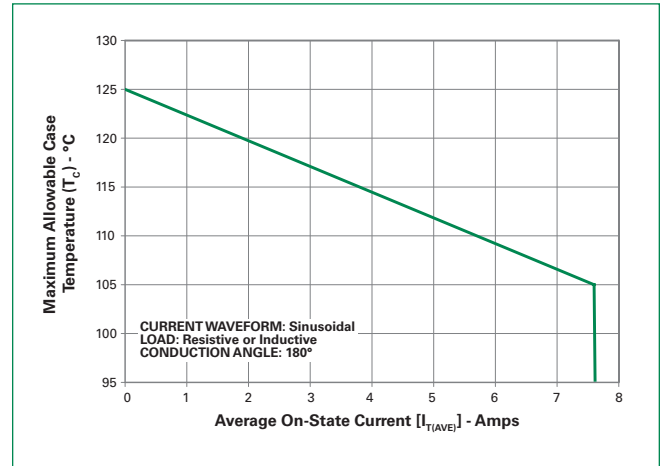
**Figure 5: Power Dissipation (Typical) vs. RMS On-State Current**



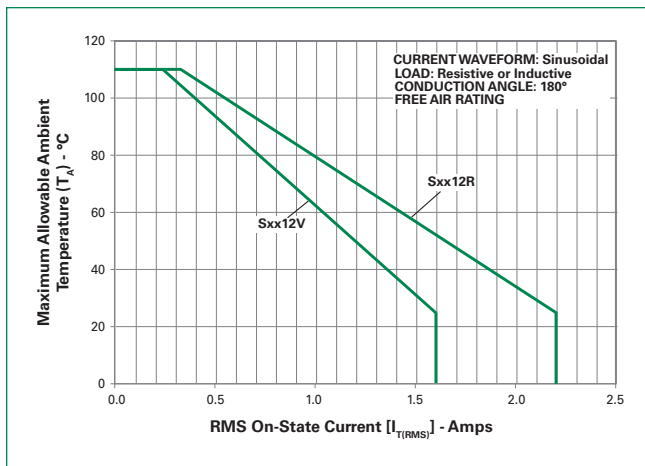
**Figure 6: Maximum Allowable Case Temperature vs. RMS On-State Current**



**Figure 7: Maximum Allowable Case Temperature vs. Average On-State Current**

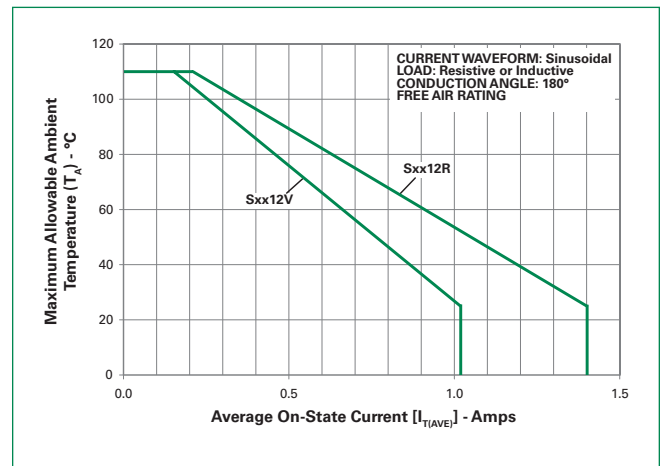


**Figure 8: Maximum Allowable Ambient Temperature vs. RMS On-State Current**

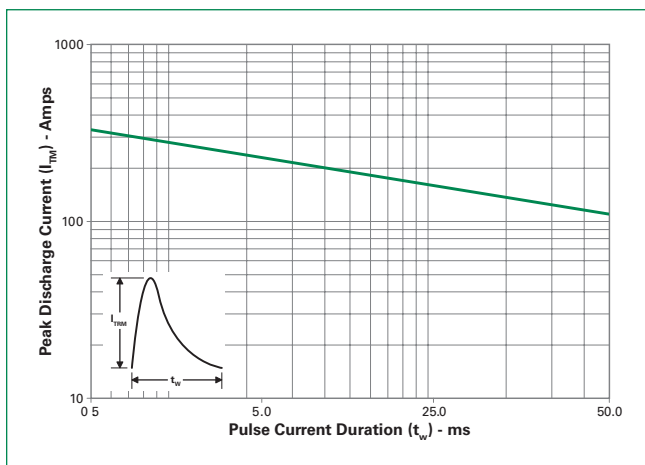


Note: xx = voltage

**Figure 9: Maximum Allowable Ambient Temperature vs. Average On-State Current**



**Figure 10: Peak Capacitor Discharge Current**



**Figure 11: Peak Capacitor Discharge Current Derating**

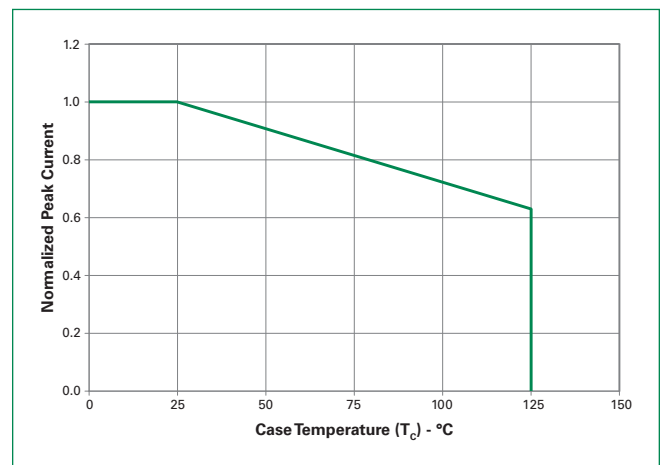
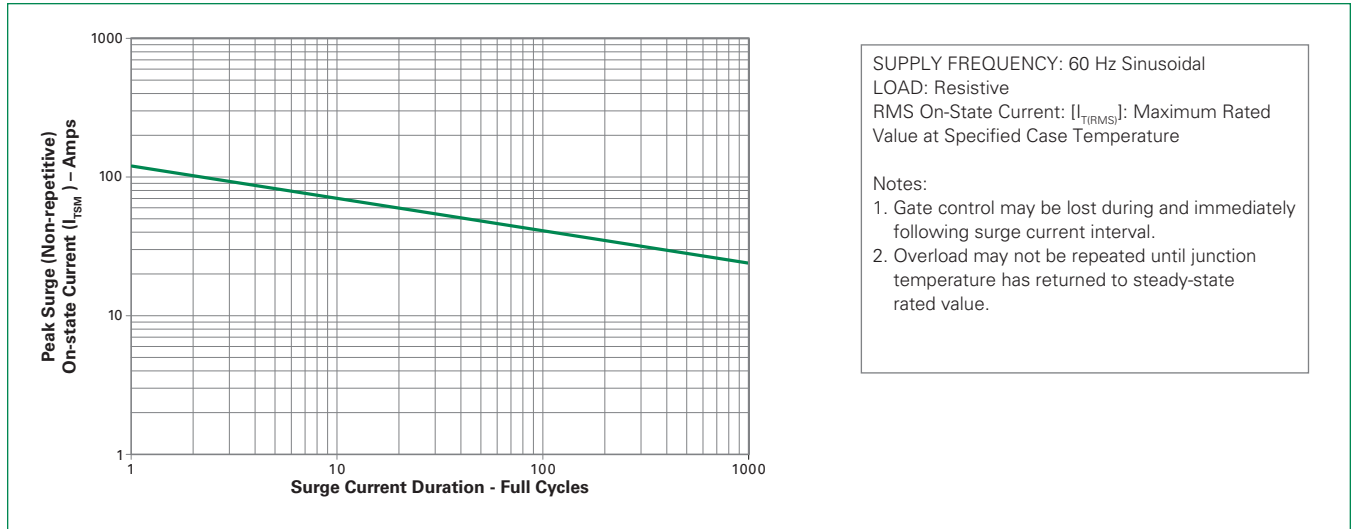
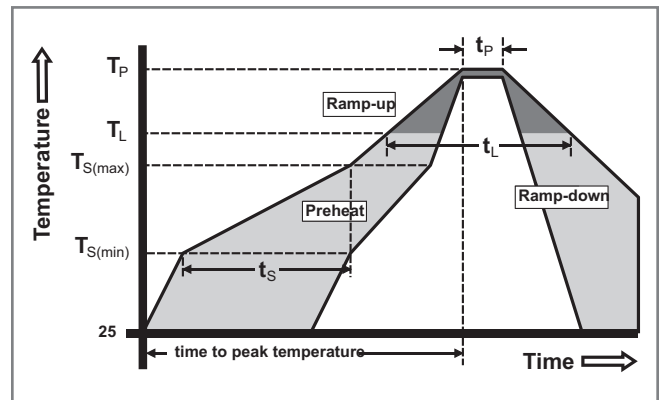


Figure 12: Surge Peak On-State Current vs. Number of Cycles



Soldering Parameters

Reflow Condition		Pb – Free assembly
Pre Heat	- Temperature Min ( $T_{s(min)}$ )	150°C
	- Temperature Max ( $T_{s(max)}$ )	200°C
	- Time (min to max) ( $t_s$ )	60 – 180 secs
Average ramp up rate (Liquidus Temp) ( $T_L$ ) to peak		5°C/second max
$T_{s(max)}$ to $T_L$ - Ramp-up Rate		5°C/second max
Reflow	- Temperature ( $T_L$ ) (Liquidus)	217°C
	- Temperature ( $t_l$ )	60 – 150 seconds
Peak Temperature ( $T_p$ )		260 <sup>+0/-5</sup> °C
Time within 5°C of actual peak Temperature ( $t_p$ )		20 – 40 seconds
Ramp-down Rate		5°C/second max
Time 25°C to peak Temperature ( $T_p$ )		8 minutes Max.
Do not exceed		280°C



**Physical Specifications**

<b>Terminal Finish</b>	100% Matte Tin-plated
<b>Body Material</b>	UL recognized epoxy meeting flammability classification 94V-0
<b>Lead Material</b>	Copper Alloy

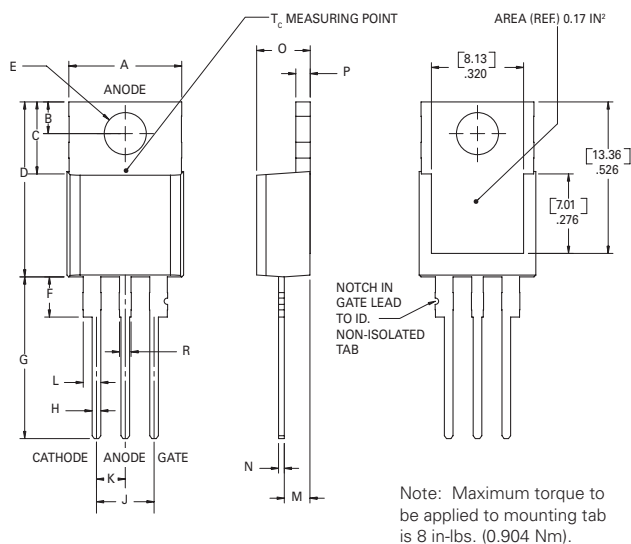
**Design Considerations**

Careful selection of the correct device for the application's operating parameters and environment will go a long way toward extending the operating life of the Thyristor. Good design practice should limit the maximum continuous current through the main terminals to 75% of the device rating. Other ways to ensure long life for a power discrete semiconductor are proper heat sinking and selection of voltage ratings for worst case conditions. Overheating, overvoltage (including dv/dt), and surge currents are the main killers of semiconductors. Correct mounting, soldering, and forming of the leads also help protect against component damage.

**Environmental Specifications**

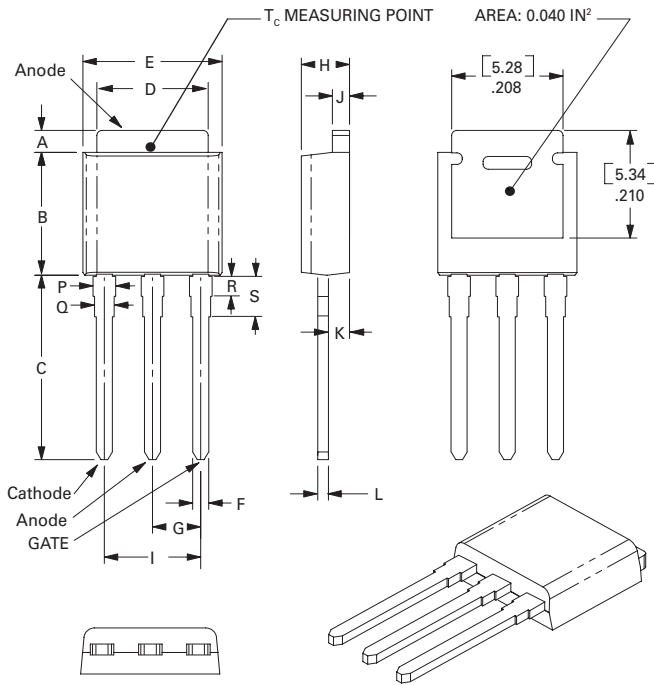
Test	Specifications and Conditions
<b>AC Blocking</b>	MIL-STD-750, M-1040, Cond A Applied Peak AC voltage @ 125°C for 1008 hours
<b>Temperature Cycling</b>	MIL-STD-750, M-1051, 100 cycles; -40°C to +150°C; 15-min dwell-time
<b>Temperature/Humidity</b>	EIA / JEDEC, JESD22-A101 1008 hours; 320V - DC: 85°C; 85% rel humidity
<b>High Temp Storage</b>	MIL-STD-750, M-1031, 1008 hours; 150°C
<b>Low-Temp Storage</b>	1008 hours; -40°C
<b>Thermal Shock</b>	MIL-STD-750, M-1056 10 cycles; 0°C to 100°C; 5-min dwell-time at each temperature; 10 sec (max) transfer time between temperature
<b>Autoclave</b>	EIA / JEDEC, JESD22-A102 168 hours (121°C at 2 ATMs) and 100% R/H
<b>Resistance to Solder Heat</b>	MIL-STD-750 Method 2031
<b>Solderability</b>	ANSI/J-STD-002, category 3, Test A
<b>Lead Bend</b>	MIL-STD-750, M-2036 Cond E

**Dimensions — TO-220AB (R-Package) — Non-Isolated Mounting Tab Common with Center Lead**



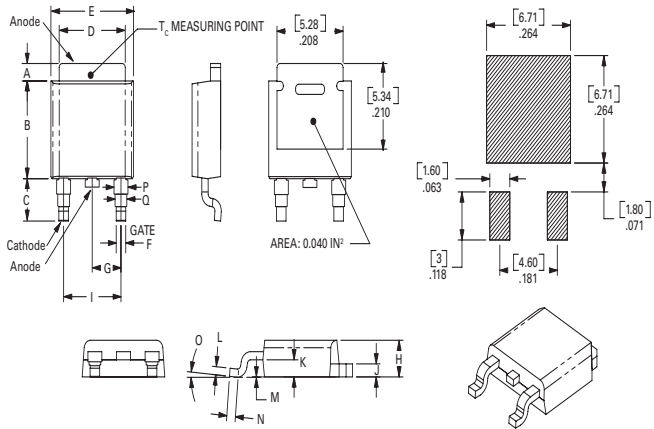
Dimension	Inches		Millimeters	
	Min	Max	Min	Max
A	0.380	0.420	9.65	10.67
B	0.105	0.115	2.67	2.92
C	0.230	0.250	5.84	6.35
D	0.590	0.620	14.99	15.75
E	0.142	0.147	3.61	3.73
F	0.110	0.130	2.79	3.30
G	0.540	0.575	13.72	14.61
H	0.025	0.035	0.64	0.89
J	0.195	0.205	4.95	5.21
K	0.095	0.105	2.41	2.67
L	0.060	0.075	1.52	1.91
M	0.085	0.095	2.16	2.41
N	0.018	0.024	0.46	0.61
O	0.178	0.188	4.52	4.78
P	0.045	0.060	1.14	1.52
R	0.038	0.048	0.97	1.22

**Dimensions — TO-251AA (V/I-Package) — V/I-PAK Through Hole**



Dimension	Inches			Millimeters		
	Min	Typ	Max	Min	Typ	Max
A	0.040	0.044	0.050	1.02	1.11	1.27
B	0.235	0.242	0.245	5.97	6.15	6.22
C	0.350	0.361	0.375	8.89	9.18	9.53
D	0.205	0.208	0.213	5.21	5.29	5.41
E	0.255	0.262	0.265	6.48	6.66	6.73
F	0.027	0.031	0.033	0.69	0.80	0.84
G	0.087	0.090	0.093	2.21	2.28	2.36
H	0.085	0.092	0.095	2.16	2.34	2.41
I	0.176	0.180	0.184	4.47	4.57	4.67
J	0.018	0.020	0.023	0.46	0.51	0.58
K	0.038	0.040	0.044	0.97	1.01	1.12
L	0.018	0.020	0.023	0.46	0.52	0.58
P	0.042	0.047	0.052	1.06	1.20	1.32
Q	0.034	0.039	0.044	0.86	1.00	1.11
R	0.034	0.039	0.044	0.86	1.00	1.11
S	0.074	0.079	0.084	1.86	2.00	2.11

**Dimensions — TO-252AA (D-Package) — D-PAK Surface Mount**



Dimension	Inches			Millimeters		
	Min	Typ	Max	Min	Typ	Max
A	0.040	0.043	0.050	1.02	1.09	1.27
B	0.235	0.243	0.245	5.97	6.16	6.22
C	0.106	0.108	0.113	2.69	2.74	2.87
D	0.205	0.208	0.213	5.21	5.29	5.41
E	0.255	0.262	0.265	6.48	6.65	6.73
F	0.027	0.031	0.033	0.69	0.80	0.84
G	0.087	0.090	0.093	2.21	2.28	2.36
H	0.085	0.092	0.095	2.16	2.33	2.41
I	0.176	0.179	0.184	4.47	4.55	4.67
J	0.018	0.020	0.023	0.46	0.51	0.58
K	0.038	0.040	0.044	0.97	1.02	1.12
L	0.018	0.020	0.023	0.46	0.51	0.58
M	0.000	0.000	0.004	0.00	0.00	0.10
N	0.021	0.026	0.027	0.53	0.67	0.69
O	0°	0°	5°	0°	0°	5°
P	0.042	0.047	0.052	1.06	1.20	1.32
Q	0.034	0.039	0.044	0.86	1.00	1.11

## Product Selector

Part Number	Voltage				Gate Sensitivity	Type	Package
	400V	600V	800V	1000V			
Sxx12R	X	X	X	X	20mA	Sensitive SCR	TO-220R
Sxx12V	X	X	X	X	20mA	Standard SCR	TO-251
Sxx12D	X	X	X	X	20mA	Standard SCR	TO-252

Note: xx = voltage

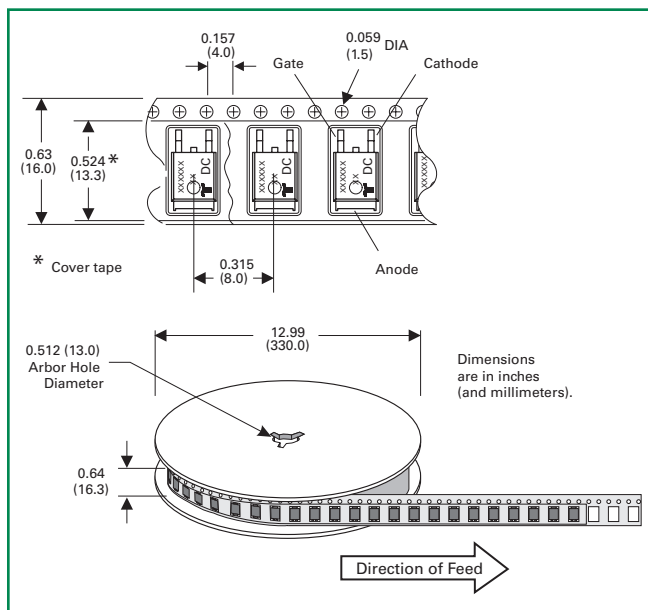
## Packing Options

Part Number	Marking	Weight	Packing Mode	Base Quantity
Sxx12R	Sxx12R	2.2 g	Bulk	500
Sxx12RTP	Sxx12R	2.2 g	Tube	500 (50 per tube)
Sxx12DTP	Sxx12D	0.3 g	Tube	750 (75 per tube)
Sxx12DRP	Sxx12D	0.3 g	Embossed Carrier	2500
Sxx12VTP	Sxx12V	0.4 g	Tube	750 (75 per tube)

Note: xx = Voltage

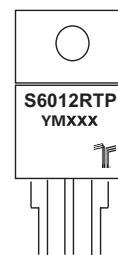
## TO-252 Embossed Carrier Reel Pack (RP) Specifications

### Meets all EIA-481-2 Standards



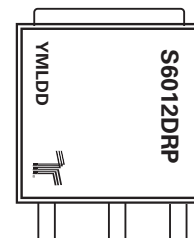
## Part Marking System

TO-220 AB – (R Package)

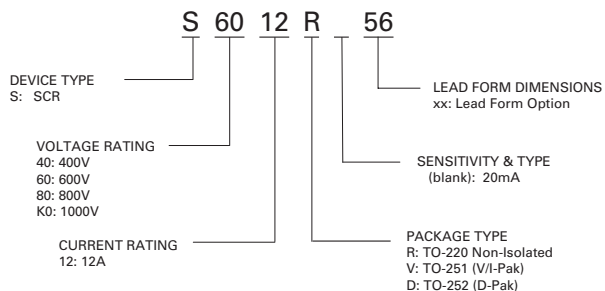


TO-251AA – (V Package)

TO-252AA – (D Package)



## Part Numbering System







Компания «ЭлектроПласт» предлагает заключение долгосрочных отношений при поставках импортных электронных компонентов на взаимовыгодных условиях!

Наши преимущества:

- Оперативные поставки широкого спектра электронных компонентов отечественного и импортного производства напрямую от производителей и с крупнейших мировых складов;
- Поставка более 17-ти миллионов наименований электронных компонентов;
- Поставка сложных, дефицитных, либо снятых с производства позиций;
- Оперативные сроки поставки под заказ (от 5 рабочих дней);
- Экспресс доставка в любую точку России;
- Техническая поддержка проекта, помощь в подборе аналогов, поставка прототипов;
- Система менеджмента качества сертифицирована по Международному стандарту ISO 9001;
- Лицензия ФСБ на осуществление работ с использованием сведений, составляющих государственную тайну;
- Поставка специализированных компонентов (Xilinx, Altera, Analog Devices, Intersil, Interpoint, Microsemi, Aeroflex, Peregrine, Syfer, Eurofarad, Texas Instrument, Miteq, Cobham, E2V, MA-COM, Hittite, Mini-Circuits, General Dynamics и др.);

Помимо этого, одним из направлений компании «ЭлектроПласт» является направление «Источники питания». Мы предлагаем Вам помощь Конструкторского отдела:

- Подбор оптимального решения, техническое обоснование при выборе компонента;
- Подбор аналогов;
- Консультации по применению компонента;
- Поставка образцов и прототипов;
- Техническая поддержка проекта;
- Защита от снятия компонента с производства.



#### Как с нами связаться

**Телефон:** 8 (812) 309 58 32 (многоканальный)

**Факс:** 8 (812) 320-02-42

**Электронная почта:** [org@eplast1.ru](mailto:org@eplast1.ru)

**Адрес:** 198099, г. Санкт-Петербург, ул. Калинина, дом 2, корпус 4, литера А.