

# High Efficiency Standard Rectifier

$$V_{RRM} = 800\text{ V}$$

$$I_{FAV} = 10\text{ A}$$

$$V_F = 1.16\text{ V}$$

Single Diode

Part number

**DLA10IM800UC**

Marking on Product: MARLUI

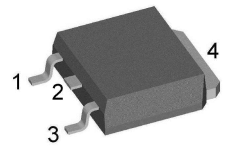

Backside: cathode

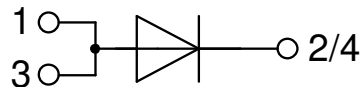

### Features / Advantages:

- Planar passivated chips
- Very low leakage current
- Very low forward voltage drop
- Improved thermal behaviour

### Applications:

- Diode for main rectification
- For single and three phase bridge configurations

### Package: TO-252 (DPak)

- Industry standard outline
- RoHS compliant
- Epoxy meets UL 94V-0

### Disclaimer Notice

Information furnished is believed to be accurate and reliable. However, users should independently evaluate the suitability of and test each product selected for their own applications. Littelfuse products are not designed for, and may not be used in, all applications. Read complete Disclaimer Notice at [www.littelfuse.com/disclaimer-electronics](http://www.littelfuse.com/disclaimer-electronics).

Rectifier				Ratings			
Symbol	Definition	Conditions		min.	typ.	max.	Unit
$V_{RSM}$	max. non-repetitive reverse blocking voltage					900	V
$V_{RRM}$	max. repetitive reverse blocking voltage					800	V
$I_R$	reverse current	$V_R = 800\text{ V}$	$T_{VJ} = 25^\circ\text{C}$			5	$\mu\text{A}$
		$V_R = 800\text{ V}$	$T_{VJ} = 150^\circ\text{C}$			0.05	mA
$V_F$	forward voltage drop	$I_F = 10\text{ A}$	$T_{VJ} = 25^\circ\text{C}$			1.22	V
		$I_F = 20\text{ A}$				1.40	V
		$I_F = 10\text{ A}$	$T_{VJ} = 150^\circ\text{C}$			1.16	V
		$I_F = 20\text{ A}$				1.45	V
$I_{FAV}$	average forward current	$T_C = 145^\circ\text{C}$ rectangular	$T_{VJ} = 175^\circ\text{C}$ d = 0.5			10	A
$V_{FO}$	threshold voltage	} for power loss calculation only				0.84	V
$r_F$	slope resistance					30	m $\Omega$
$R_{thJC}$	thermal resistance junction to case					2	K/W
$R_{thCH}$	thermal resistance case to heatsink				0.50		K/W
$P_{tot}$	total power dissipation			$T_C = 25^\circ\text{C}$		75	W
$I_{FSM}$	max. forward surge current	t = 10 ms; (50 Hz), sine	$T_{VJ} = 45^\circ\text{C}$			120	A
		t = 8,3 ms; (60 Hz), sine	$V_R = 0\text{ V}$			130	A
		t = 10 ms; (50 Hz), sine	$T_{VJ} = 150^\circ\text{C}$			100	A
		t = 8,3 ms; (60 Hz), sine	$V_R = 0\text{ V}$			110	A
$I^2t$	value for fusing	t = 10 ms; (50 Hz), sine	$T_{VJ} = 45^\circ\text{C}$			72	A <sup>2</sup> s
		t = 8,3 ms; (60 Hz), sine	$V_R = 0\text{ V}$			70	A <sup>2</sup> s
		t = 10 ms; (50 Hz), sine	$T_{VJ} = 150^\circ\text{C}$			50	A <sup>2</sup> s
		t = 8,3 ms; (60 Hz), sine	$V_R = 0\text{ V}$			50	A <sup>2</sup> s
$C_J$	junction capacitance	$V_R = 400\text{ V}; f = 1\text{ MHz}$		$T_{VJ} = 25^\circ\text{C}$		3	pF



Package TO-252 (DPak)			Ratings			
Symbol	Definition	Conditions	min.	typ.	max.	Unit
$I_{RMS}$	RMS current	per terminal <sup>1)</sup>			20	A
$T_{VJ}$	virtual junction temperature		-55		175	°C
$T_{op}$	operation temperature		-55		150	°C
$T_{stg}$	storage temperature		-55		150	°C
<b>Weight</b>				0.3		g
$F_C$	mounting force with clip		20		60	N

<sup>1)</sup>  $I_{RMS}$  is typically limited by the pin-to-chip resistance (1); or by the current capability of the chip (2). In case of (1) and a product with multiple pins for one chip-potential, the current capability can be increased by connecting the pins as one contact.

**Product Marking**

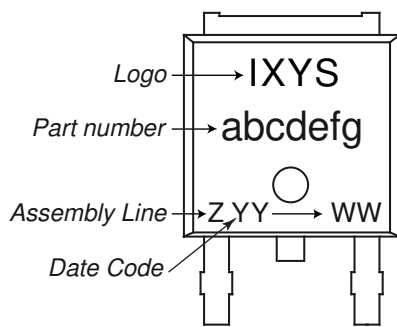

**Part description**

- D = Diode
- L = High Efficiency Standard Rectifier
- A = (up to 1200V)
- 10 = Current Rating [A]
- IM = Single Diode
- 800 = Reverse Voltage [V]
- UC = TO-252AA (DPak)

Ordering	Ordering Number	Marking on Product	Delivery Mode	Quantity	Code No.
Standard	DLA10IM800UC-TRL	MARLUI	Tape & Reel	2500	503668
Alternative	DLA10IM800UC-TUB	MARLUI	Tube	70	523435

**Equivalent Circuits for Simulation**

\* on die level

$T_{VJ} = 175\text{ °C}$



**Rectifier**

$V_{0\ max}$	threshold voltage	0.84	V
$R_{0\ max}$	slope resistance *	27	mΩ



**Outlines TO-252 (DPak)**

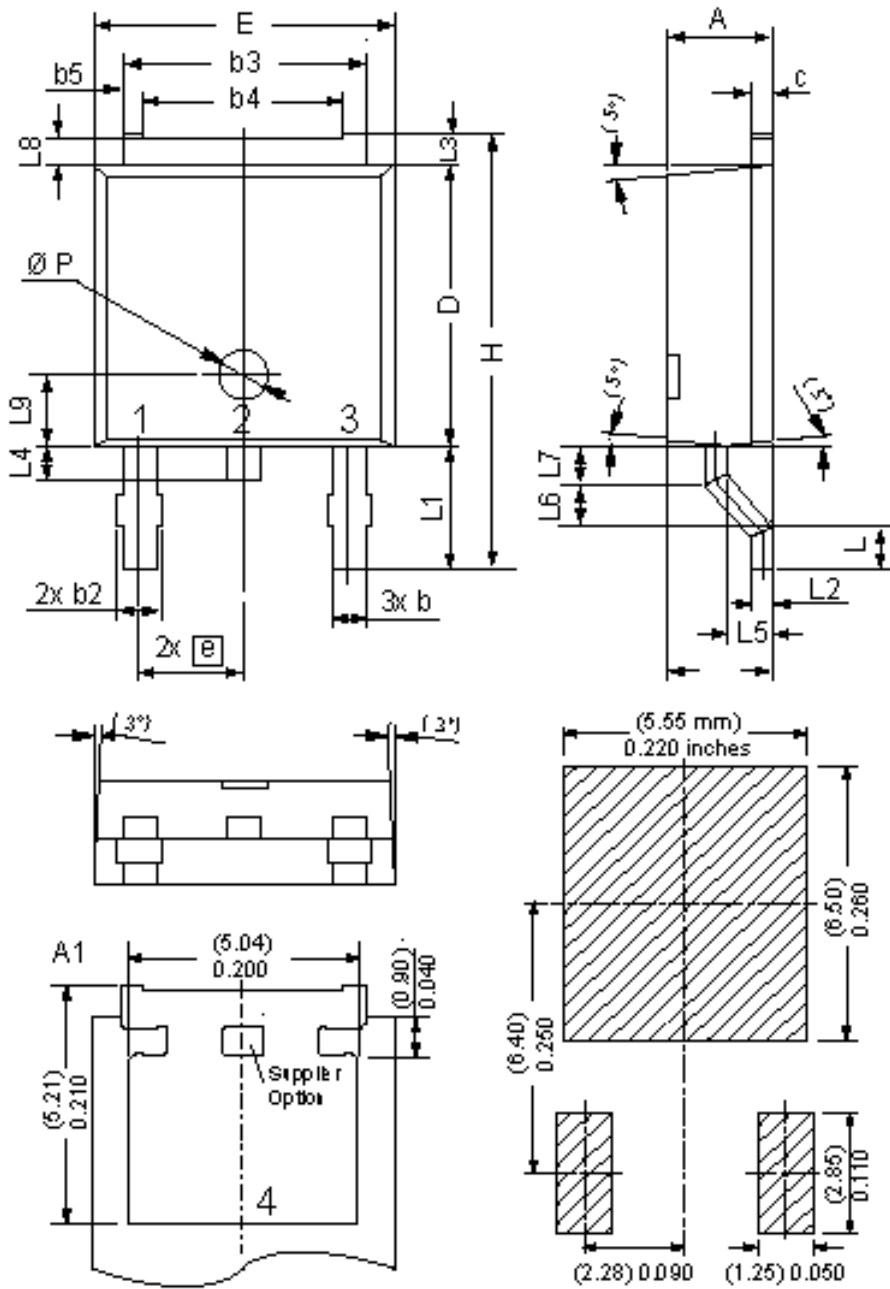

Dim	Millimeters		Inches	
	min	max	min	max
A	2.20	2.40	0.087	0.094
A1	2.10	2.50	0.083	0.098
b	0.66	0.86	0.026	0.034
b2	-	0.96	-	0.038
b3	5.04	5.64	0.198	0.222
b4	4.34 BSC		0.171 BSC	
b5	0.50 BSC		0.020 BSC	
c	0.40	0.86	0.016	0.034
D	5.90	6.30	0.232	0.248
E	6.40	6.80	0.252	0.268
e	2.10	2.50	0.083	0.098
H	9.20	10.10	0.362	0.398
L	0.55	1.28	0.022	0.050
L1	2.50	2.90	0.098	0.114
L2	0.40	0.60	0.016	0.024
L3	0.50	0.90	0.020	0.035
L4	0.60	1.00	0.024	0.039
L5	0.82	1.22	0.032	0.048
L6	0.79	0.99	0.031	0.039
L7	0.81	1.01	0.032	0.040
L8	0.40	0.80	0.016	0.031
L9	1.50 BSC		0.059 BSC	
Ø P	1.00 BSC		0.039 BSC	

Recommended min. footprint

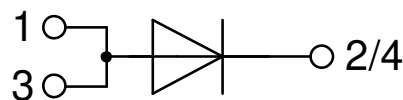



**Rectifier**

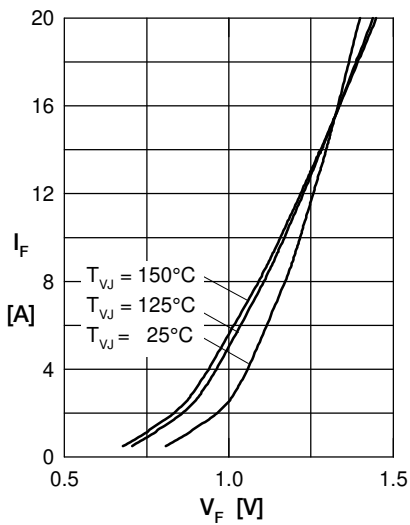

Fig. 1 Forward current versus voltage drop

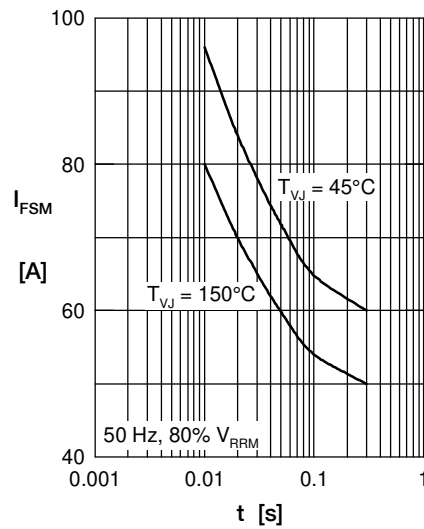

Fig. 2 Surge overload current

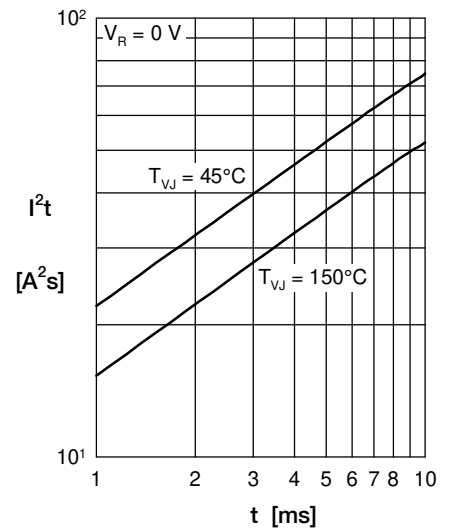

Fig. 3  $I^2t$  versus time

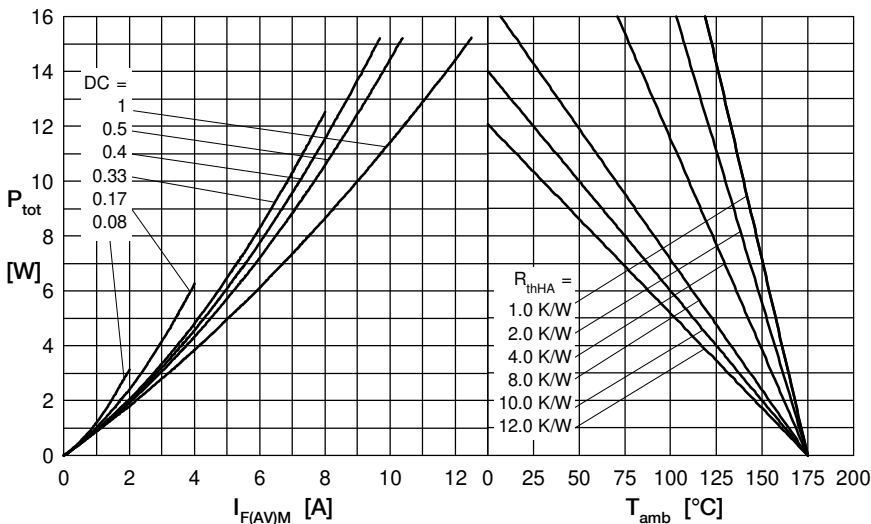

Fig. 4 Power dissipation versus direct output current and ambient temperature

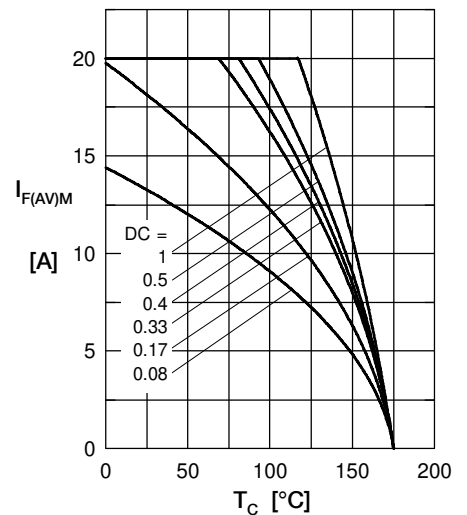

Fig. 5 Max. forward current vs. case temperature

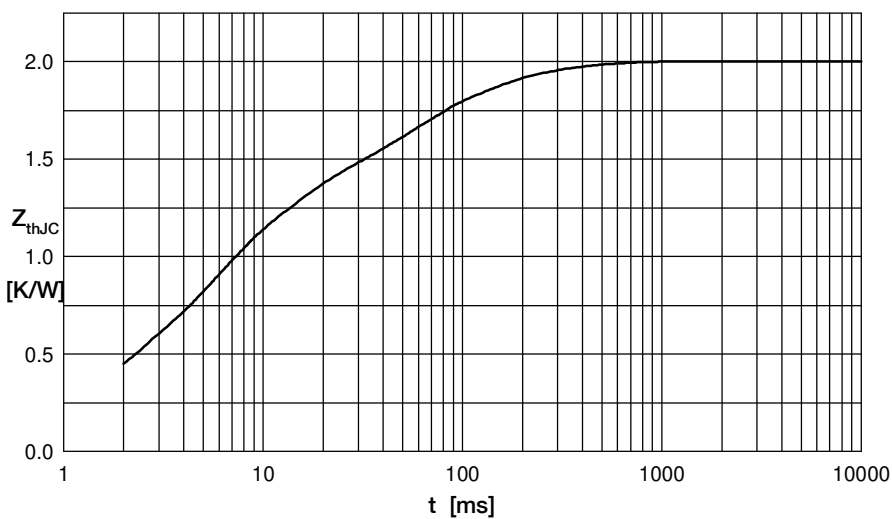

Fig. 6 Transient thermal impedance junction to case

Constants for  $Z_{thJC}$  calculation:

i	$R_{thi}$ (K/W)	$t_i$ (s)
1	1.1	0.005
2	0.06	0.0003
3	0.14	0.045
4	0.2	0.2
5	0.5	0.05



Компания «ЭлектроПласт» предлагает заключение долгосрочных отношений при поставках импортных электронных компонентов на взаимовыгодных условиях!

Наши преимущества:

- Оперативные поставки широкого спектра электронных компонентов отечественного и импортного производства напрямую от производителей и с крупнейших мировых складов;
- Поставка более 17-ти миллионов наименований электронных компонентов;
- Поставка сложных, дефицитных, либо снятых с производства позиций;
- Оперативные сроки поставки под заказ (от 5 рабочих дней);
- Экспресс доставка в любую точку России;
- Техническая поддержка проекта, помощь в подборе аналогов, поставка прототипов;
- Система менеджмента качества сертифицирована по Международному стандарту ISO 9001;
- Лицензия ФСБ на осуществление работ с использованием сведений, составляющих государственную тайну;
- Поставка специализированных компонентов (Xilinx, Altera, Analog Devices, Intersil, Interpoint, Microsemi, Aeroflex, Peregrine, Syfer, Eurofarad, Texas Instrument, Miteq, Cobham, E2V, MA-COM, Hittite, Mini-Circuits, General Dynamics и др.);

Помимо этого, одним из направлений компании «ЭлектроПласт» является направление «Источники питания». Мы предлагаем Вам помощь Конструкторского отдела:

- Подбор оптимального решения, техническое обоснование при выборе компонента;
- Подбор аналогов;
- Консультации по применению компонента;
- Поставка образцов и прототипов;
- Техническая поддержка проекта;
- Защита от снятия компонента с производства.



#### Как с нами связаться

**Телефон:** 8 (812) 309 58 32 (многоканальный)

**Факс:** 8 (812) 320-02-42

**Электронная почта:** [org@eplast1.ru](mailto:org@eplast1.ru)

**Адрес:** 198099, г. Санкт-Петербург, ул. Калинина, дом 2, корпус 4, литера А.