

20 19 18 17 16 15 14 13 12 11 10 9 8 7 6 5 4 3 2 1

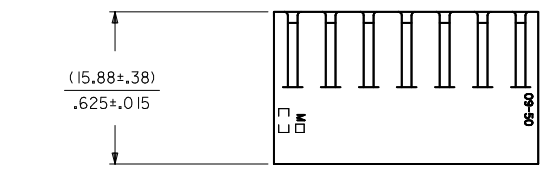
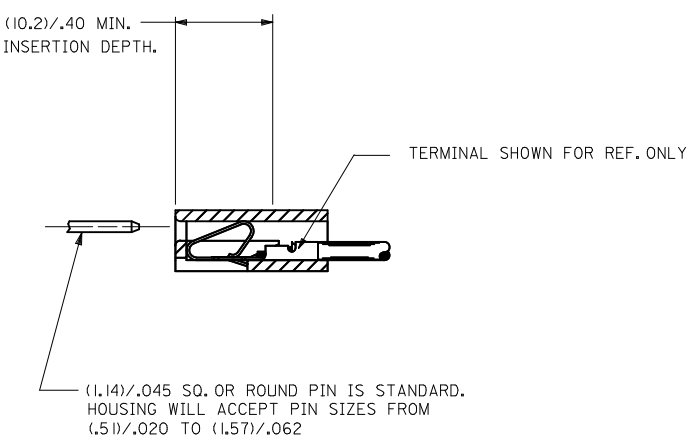
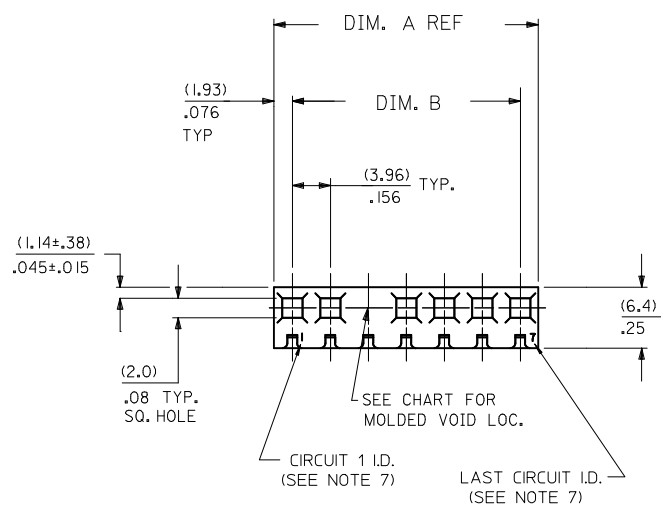

(1.14)±.045 SQ. OR ROUND PIN IS STANDARD.
HOUSING WILL ACCEPT PIN SIZES FROM
(.51)±.020 TO (1.57)±.062

OPTION CODE

OPT. CODE	RAMP	PACKAGING
A	STD. RAMP	PK-2139-001
C	NONE	

NO. OF CKT'S. 2139-N* - **

VOID CODE NO. CORRESPONDS TO CKT. NO. VOIDED. MULT. VOIDS START WITH 51.

DIM. A	DIM. B	NO. OF CKTS
(7.82)	(3.96±.13)	2
.308	.156±.005	
(11.79)	(7.92±.13)	3
.464	.312±.005	
(15.75)	(11.89±.13)	4
.620	.468±.005	
(19.71)	(15.85±.13)	5
.776	.624±.005	
(23.67)	(19.81±.13)	6
.932	.780±.005	
(27.64)	(23.77±.13)	7
1.088	.936±.005	
(31.60)	(27.74±.25)	8
1.244	1.092±.010	
(35.56)	(31.70±.25)	9
1.400	1.248±.010	
(39.52)	(35.66±.25)	10
1.556	1.404±.010	
(43.48)	(39.62±.25)	11
1.712	1.560±.010	
(47.45)	(43.59±.25)	12
1.868	1.716±.010	
(51.41)	(47.55±.31)	13
2.024	1.872±.012	
(55.37)	(51.51±.36)	14
2.180	2.028±.014	
(59.33)	(55.47±.36)	15
2.336	2.184±.014	
(63.30)	(59.44±.36)	16
2.492	2.340±.014	
(67.26)	(63.40±.36)	17
2.648	2.496±.014	
(71.22)	(67.36±.36)	18
2.804	2.652±.014	
(75.18)	(71.32±.36)	19
2.960	2.808±.014	
(79.15)	(75.29±.36)	20
3.116	2.964±.014	
(83.11)	(79.25±.46)	21
3.272	3.120±.018	
(87.07)	(83.21±.46)	22
3.428	3.276±.018	
(91.03)	(87.17±.46)	23
3.584	3.432±.018	
(95.00)	(91.14±.46)	24
3.740	3.588±.018	

- NOTES:
1. MATERIAL: NYLON, UL94V-2, COLOR: NATURAL
 2. FINISH: N/A
 3. PARTS CONFORM TO PRODUCT SPECIFICATION PS-08-50.
 4. PACKAGING INFORMATION: SEE LEGEND
 5. THIS HOUSING FOR USE WITH TERMINAL NO. 2478 (18 TO 24 GA) & 2578 (22 TO 26 GA). WITH (2.54)±.100 MAX. INSULATION DIA., HOUSING 41695 IS RECOMMENDED FOR OVER (2.54)±.100 DIA. INSULATION.
 6. DIMENSIONS GIVEN ACROSS CENTERLINES ARE SYMMETRICAL ABOUT THOSE CENTERLINES WITHIN HALF THE TOTAL TOLERANCE.
 7. FIRST CKT. NO. ON 2 THRU 5 CKT. HOUSINGS, FIRST AND LAST CKT. NO. ON 6 CKT HOUSING AND LARGER.
 8. MAX BOW .005 MM/MM OR .005 IN/IN
 9. THIS PART CONFORMS TO CLASS B REQUIREMENTS OF COSMETIC SPECIFICATION PS-45499-002.

OPTION C PKG EC NO. UCP202-2773 DRAWN BY: 2/01/03/06 CHECKED BY: 2/01/03/06 APPR: SMITH 2/01/03/06 AG	QUALITY SYMBOLS ∇=0 ∇=0 ∇=0	GENERAL TOLERANCES (UNLESS SPECIFIED) mm INCH 4 PLACES ± --- ± --- 3 PLACES ± --- ± .010 2 PLACES ± 0.25 ± .014 1 PLACE ± 0.36 ± --- ANGULAR ± 1/2°	DIMENSION STYLE MM/IN DRAWN BY: SAMIEC DATE: 1986/01/17 CHECKED BY: DATE: 1986/01/17 APPROVED BY: LENZ DATE: 1986/01/07	SCALE: 4:1 DESIGN UNITS: INCH THIRD ANGLE PROJECTION	TITLE: CONNECTOR HOUSING .156 CL CRIMP TERMINAL 2139 SERIES DWG. MOLEX INCORPORATED DOCUMENT NO. SD-2139	SHEET NO. 1 OF 2
	DRAFT WHERE APPLICABLE MUST REMAIN WITHIN DIMENSIONS		SEE CHART	THIS DRAWING CONTAINS INFORMATION THAT IS PROPRIETARY TO MOLEX INCORPORATED AND SHOULD NOT BE USED WITHOUT WRITTEN PERMISSION		
			SIZE D			

19 18 17 16 15 14 13 12 11 10 9 8 7 6 5 4 3 2 1

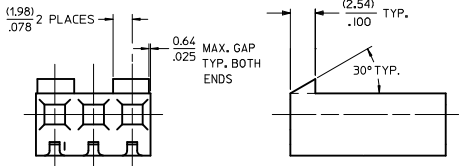

NO. OF CKT'S.	STANDARD RAMP IS LOCATED ON # OF CKT. NOS.
2	ACROSS ENTIRE PART
3	1,3
4	1,4
5	1,3,5
6	1,3,4,6
7	ACROSS ENTIRE PART
8	1,3,6,8
9	ACROSS ENTIRE PART
10	1,3,5,6,8,10
11	ACROSS ENTIRE PART
12	1,3,5,8,10,12
13	1,3,5,7,9,11,13
14	1,3,5,7,8,10,12,14
15	1,3,5,7,9,11,13,15
16	1,3,5,7,10,12,14,16
17	1,3,5,7,9,11,13,15,17
18	1,3,5,7,9,10,12,14,16,18
19	1,3,5,7,9,11,13,15,17,19
20	1,3,5,7,9,12,14,16,18,20
21	1,3,5,7,9,11,13,15,17,19,21
22	1,3,5,7,9,11,12,14,16,18,20,22
23	1,3,5,7,9,11,13,15,17,19,21,23
24	1,3,5,7,9,11,14,16,18,20,22,24

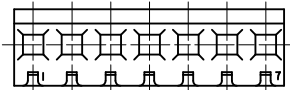
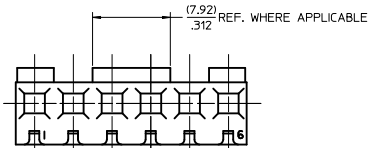
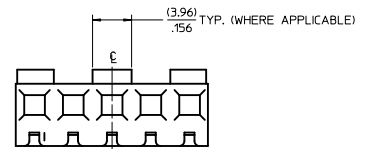
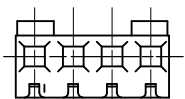

STD. RAMP OPTION
SEE CHART FOR RAMP LOCATIONS.

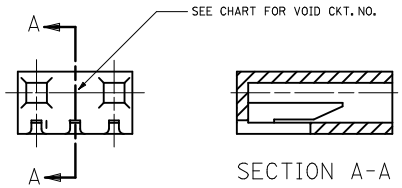

MOLDED VOID OPTION



ALTERNATE ENGRAVING LOCATION

2139-NA-*			2139-NC-*		
ORDER NO.	ENG. NO.	VOIDS	ORDER NO.	ENG. NO.	VOIDS
09-50-3021	2139-2A		09-50-7021	2139-2C	
09-50-3031	2139-3A		09-50-7031	2139-3C	
09-50-3041	2139-4A		09-50-7041	2139-4C	
09-50-3051	2139-5A		09-50-7051	2139-5C	
09-50-3061	2139-6A		09-50-7061	2139-6C	
09-50-3071	2139-7A		09-50-7071	2139-7C	
09-50-3081	2139-8A		09-50-7081	2139-8C	
09-50-3091	2139-9A		09-50-7091	2139-9C	
09-50-3101	2139-10A		09-50-7101	2139-10C	
09-50-3111	2139-11A		09-50-7111	2139-11C	
09-50-3121	2139-12A		09-50-7121	2139-12C	
09-50-3131	2139-13A		09-50-7131	2139-13C	
09-50-3141	2139-14A		09-50-7141	2139-14C	
09-50-3151	2139-15A		09-50-7151	2139-15C	
09-50-3161	2139-16A		09-50-7161	2139-16C	
09-50-3171	2139-17A		09-50-7171	2139-17C	
09-50-3181	2139-18A		09-50-7181	2139-18C	
09-50-3191	2139-19A		09-50-7191	2139-19C	
09-50-3201	2139-20A		09-50-7201	2139-20C	
09-50-3211	2139-21A		09-50-7211	2139-21C	
09-50-3221	2139-22A		09-50-7221	2139-22C	
09-50-3231	2139-23A		09-50-7231	2139-23C	
09-50-3241	2139-24A		09-50-7241	2139-24C	
09-50-3036	2139-3A-2	2	09-50-7117	2139-11C-51	2,7,10
	2139-10A-2	2	09-50-7166	2139-16C-2	2
	2139-10A-51	2,5	09-50-7106	2139-10C-2	2
	2139-7A-2	2	09-50-7107	2139-10C-51	2,5
	2139-11A-51	2,7,10	09-50-7076	2139-7C-2	2
09-50-3163	2139-16A-2	2		2139-4C-3	3
09-50-3073	2139-10A-7	7	T 09-50-7108	2139-10C-4	4
09-50-3083	2139-10A-8	8	T 09-50-7109	2139-10C-5	5
09-50-3104	2139-10A-9	9		2139-5C-2	2
09-50-3162	2139-16A-51	2,15	09-50-3077	2139-7C-3	3
09-50-3092	2139-9A-51	2,6	09-50-3078	2139-7C-5	5
09-50-3075	2139-7A-51	1,7	09-50-7142	2139-14C-5	5
	2139-7A-6	6			
	2139-5A-51	2,4			
09-50-3047	2139-4A-3	3			
	2139-11A-2	2			
09-50-3052	2139-5A-4	4			
09-50-3076	2139-7A-52	4,7			
09-50-3125	2139-12A-5	5			
	2139-7A-3	3			
	2139-7A-5	5			
09-50-3053	2139-5A-2	2			
	2139-9A-2	2			
09-50-3127	2139-12A-2	2			
09-50-3143	2139-14A-2	2			
09-50-3202	2139-20A-2	2			
	2139-9A-4	4			
09-50-3126	2139-12A-11	11			
09-50-3142	2139-14A-13	13			
09-50-3084	2139-8A-4	4			
09-50-3037	2139-3A-3	3			
09-50-3182	2139-18A-2	2			
09-50-3157	2139-15A-2	2			

RAMP DIMENSIONS IEC NO: IJCF2012-1374 DRAWN BY: DRWNK/KIPER 2011/10/27 CHECKED BY: CHYD/BANDERSON 2011/10/27 APPR:FSM/TH 2011/11/07	QUALITY SYMBOLS	GENERAL TOLERANCES (UNLESS SPECIFIED)	DIMENSION STYLE	SCALE	DESIGN UNITS	THIRD ANGLE PROJECTION
	▽=0	mm INCH	MM/IN	4:1	INCH	☉
	▽=0	4 PLACES ± --- ± ---	DRAWN BY DATE	TITLE		
	▽=0	3 PLACES ± --- ±.010	SAMIEC 1986/01/17	CONNECTOR HOUSING FOR CRIMP TERMINAL 2139 SERIES DWG.		
	2 PLACES ± 0.25 ±.014	CHECKED BY DATE	MOLEX INCORPORATED			
	1 PLACE ± 0.36 ± ---	APPROVED BY DATE	MATERIAL NO. SD-2139			
	ANGULAR ±1/2°	LENZ 1986/01/17	DOCUMENT NO. 2 OF 2			
	DRAFT WHERE APPLICABLE MUST REMAIN WITHIN DIMENSIONS	SEE CHART	THIS DRAWING CONTAINS INFORMATION THAT IS PROPRIETARY TO MOLEX INCORPORATED AND SHOULD NOT BE USED WITHOUT WRITTEN PERMISSION			



Компания «ЭлектроПласт» предлагает заключение долгосрочных отношений при поставках импортных электронных компонентов на взаимовыгодных условиях!

Наши преимущества:

- Оперативные поставки широкого спектра электронных компонентов отечественного и импортного производства напрямую от производителей и с крупнейших мировых складов;
- Поставка более 17-ти миллионов наименований электронных компонентов;
- Поставка сложных, дефицитных, либо снятых с производства позиций;
- Оперативные сроки поставки под заказ (от 5 рабочих дней);
- Экспресс доставка в любую точку России;
- Техническая поддержка проекта, помощь в подборе аналогов, поставка прототипов;
- Система менеджмента качества сертифицирована по Международному стандарту ISO 9001;
- Лицензия ФСБ на осуществление работ с использованием сведений, составляющих государственную тайну;
- Поставка специализированных компонентов (Xilinx, Altera, Analog Devices, Intersil, Interpoint, Microsemi, Aeroflex, Peregrine, Syfer, Eurofarad, Texas Instrument, Miteq, Cobham, E2V, MA-COM, Hittite, Mini-Circuits, General Dynamics и др.);

Помимо этого, одним из направлений компании «ЭлектроПласт» является направление «Источники питания». Мы предлагаем Вам помощь Конструкторского отдела:

- Подбор оптимального решения, техническое обоснование при выборе компонента;
- Подбор аналогов;
- Консультации по применению компонента;
- Поставка образцов и прототипов;
- Техническая поддержка проекта;
- Защита от снятия компонента с производства.



Как с нами связаться

Телефон: 8 (812) 309 58 32 (многоканальный)

Факс: 8 (812) 320-02-42

Электронная почта: org@eplast1.ru

Адрес: 198099, г. Санкт-Петербург, ул. Калинина, дом 2, корпус 4, литера А.