



Universal Multiwinding Transformers

PCA type

PCA series

PCA11/5ER
PCA14.5/6ER
PCA15EFD
PCA20EFD

REMINDERS FOR USING THESE PRODUCTS

Before using these products, be sure to request the delivery specifications.

SAFETY REMINDERS

Please pay sufficient attention to the warnings for safe designing when using these products.

REMINDERS

- The storage period is less than 12 months. Be sure to follow the storage conditions (Temperature: 5 to 40°C, Humidity: 10 to 75% RH or less).
If the storage period elapses, the soldering of the terminal electrodes may deteriorate.
- Do not use or store in locations where there are conditions such as gas corrosion (salt, acid, alkali, etc.).
- Before soldering, be sure to preheat components.
The preheating temperature should be set so that the temperature difference between the solder temperature and chip temperature does not exceed 150°C.
- Soldering corrections after mounting should be within the range of the conditions determined in the specifications.
If overheated, a short circuit, performance deterioration, or lifespan shortening may occur.
- When embedding a printed circuit board where a chip is mounted to a set, be sure that residual stress is not given to the chip due to the overall distortion of the printed circuit board and partial distortion such as at screw tightening portions.
- Self heating (temperature increase) occurs when the power is turned ON, so the tolerance should be sufficient for the set thermal design.
- Carefully lay out the coil for the circuit board design of the non-magnetic shield type.
A malfunction may occur due to magnetic interference.
- Use a wrist band to discharge static electricity in your body through the grounding wire.
- Do not expose the products to magnets or magnetic fields.
- Do not use for a purpose outside of the contents regulated in the delivery specifications.
- The products listed on this catalog are intended for use in general electronic equipment (AV equipment, telecommunications equipment, home appliances, amusement equipment, computer equipment, personal equipment, office equipment, measurement equipment, industrial robots) under a normal operation and use condition.
The products are not designed or warranted to meet the requirements of the applications listed below, whose performance and/or quality require a more stringent level of safety or reliability, or whose failure, malfunction or trouble could cause serious damage to society, person or property.
If you intend to use the products in the applications listed below or if you have special requirements exceeding the range or conditions set forth in the each catalog, please contact us.

- (1) Aerospace/Aviation equipment
- (2) Transportation equipment (cars, electric trains, ships, etc.)
- (3) Medical equipment
- (4) Power-generation control equipment
- (5) Atomic energy-related equipment
- (6) Seabed equipment
- (7) Transportation control equipment

- (8) Public information-processing equipment
- (9) Military equipment
- (10) Electric heating apparatus, burning equipment
- (11) Disaster prevention/crime prevention equipment
- (12) Safety equipment
- (13) Other applications that are not considered general-purpose applications

When designing your equipment even for general-purpose applications, you are kindly requested to take into consideration securing protection circuit/device or providing backup circuits in your equipment.

Universal Multiwinding Transformers

Product compatible with RoHS directive
Compatible with lead-free solders

PCA Type

Overview of the PCA Series

FEATURES

- Multi-functional DC/DC transformers with each type provided with six cores, available in various inductance values.
- Supporting various turn ratios and inductance values when coils are arbitrarily connected externally, and can be used for many different purposes.
- Can be used as inductors (coupled, step-down, step-up, resonance) or DC/DC transformers (flyback, forward, push-pull).
- Supporting automatic winding and achieves high quality and stable production.
- Available in four types.

APPLICATION

POL(Point of Load) DC/DC converters, digital home appliances, initial DC/DC power circuit check

PART NUMBER CONSTRUCTION

PCA	11/5	ER	-	U	01	S	002
Series name		Core shape		Internal code			

OPERATING TEMPERATURE RANGE, PACKAGE QUANTITY, PRODUCT WEIGHT

Type	Temperature range		Package quantity	Individual weight
	Operating temperature*	Storage temperature**		
	(°C)	(°C)	(pieces/reel)	(g)
PCA11/5ER	-40 to +85	-40 to +85	1500	1.5
PCA14.5/6ER	-40 to +85	-40 to +85	600	2.9
PCA15EFD	-40 to +85	-40 to +85	500	6.0
PCA20EFD	-40 to +85	-40 to +85	400	13.5

* Operating temperature range includes self-temperature rise.

** The Storage temperature range is for after the circuit board is mounted.

RoHS Directive Compliant Product: See the following for more details related to RoHS Directive compliant products. <http://www.tdk.co.jp/rohs/>

• All specifications are subject to change without notice.

Overview of the PCA Series

RECOMMENDED REFLOW PROFILE



Preheating			Soldering		Peak	
Temp.	Temp.	Time	Temp.	Time	Temp.	Time
T1	T2	t1	T3	t2	T4	t3
150°C	180°C	60 to 120s	230°C	10 to 30s	245°C	5s max.

PCA series

PCA11/5ER Type

SHAPE & DIMENSIONS



Dimensions in mm

RECOMMENDED LAND PATTERN

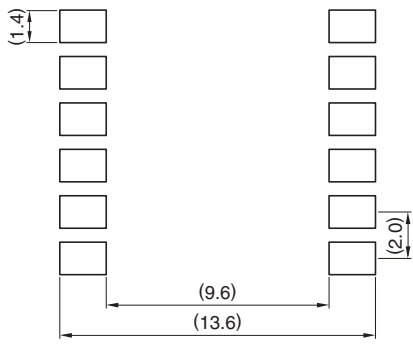

Suggested PCB layout

Dimensions in mm

CIRCUIT DIAGRAM

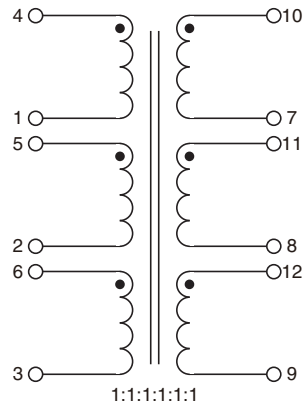

• All specifications are subject to change without notice.

PCA series PCA11/5ER Type

ELECTRICAL CHARACTERISTICS

CHARACTERISTICS SPECIFICATION TABLE

Part No.	Inductance (μH) @10KHz,0.1Vrms		Idc 1 ^{*1} (Amps) Typ.		Idc 2 ^{*2} (Amps) Typ.		DCR ($\text{m}\Omega$) $\pm 15\%$		ET Constant ($\text{V}\cdot\mu\text{S}$) max.		Leakage Inductance (nH)Typ.
	Parallel ^{*3}	Series ^{*4}	Parallel ^{*3}	Series ^{*4}	Parallel ^{*3}	Series ^{*4}	Parallel ^{*3}	Series ^{*4}	Parallel ^{*3}	Series ^{*4}	Single
PCA11/5ER-U01S002	193.0 $\pm 30\%$	6.9mH $\pm 30\%$	0.11	0.02	2.6	0.44	44.4	1607	42.8	257	183
PCA11/5ER-U02S002	85.8 $\pm 30\%$	3.1mH $\pm 30\%$	0.17	0.03	4.2	0.70	18.4	668	28.6	171	155
PCA11/5ER-U03S002	27.4 $\pm 20\%$	985 $\pm 20\%$	1.76	0.29	2.6	0.44	44.4	1607	42.8	257	183
PCA11/5ER-U04S002	12.2 $\pm 20\%$	438 $\pm 20\%$	2.60	0.43	4.2	0.70	18.4	668	28.6	171	155
PCA11/5ER-U05S002	14.7 $\pm 20\%$	529 $\pm 20\%$	3.74	0.62	2.6	0.44	44.4	1607	42.8	257	183
PCA11/5ER-U06S002	6.5 $\pm 20\%$	235 $\pm 20\%$	5.26	0.88	4.2	0.70	18.4	668	28.6	171	155
PCA11/5ER-U07S002	10.9 $\pm 20\%$	394 $\pm 20\%$	5.19	0.87	2.6	0.44	44.4	1607	42.8	257	183
PCA11/5ER-U08S002	4.9 $\pm 20\%$	175 $\pm 20\%$	7.50	1.25	4.2	0.70	18.4	668	28.6	171	155
PCA11/5ER-U09S002	8.5 $\pm 20\%$	306 $\pm 20\%$	6.57	1.10	2.6	0.44	44.4	1607	42.8	257	183
PCA11/5ER-U10S002	3.8 $\pm 20\%$	136 $\pm 20\%$	9.24	1.54	4.2	0.70	18.4	668	28.6	171	155

Electrical Specifications @23°C

*1 Idc 1 = Depend on inductance saturation. (30% below the initial value).

*2 Idc 2 = Depend on self temperature rise. (Temperature increase of 40°C).

*3 Parallel = 6 coils connected in parallel.

*4 Series = 6 coils connected in series.

PCA series

PCA14.5/6ER Type

SHAPE & DIMENSIONS



Dimensions in mm

RECOMMENDED LAND PATTERN



Suggested PCB layout

Dimensions in mm

CIRCUIT DIAGRAM



• All specifications are subject to change without notice.

PCA series **PCA14.5/6ER Type**

■ ELECTRICAL CHARACTERISTICS

□ CHARACTERISTICS SPECIFICATION TABLE

Part No.	Inductance (μH) @10KHz,0.1Vrms		Idc 1*1 (Amps) Typ.		Idc 2*2 (Amps) Typ.		DCR ($\text{m}\Omega$) $\pm 15\%$		ET Constant (V- μS) max.		Leakage Inductance (nH)Typ.
	Parallel*3	Series*4	Parallel*3	Series*4	Parallel*3	Series*4	Parallel*3	Series*4	Parallel*3	Series*4	Single
PCA14.5/6ER-U01S002	160.0 $\pm 30\%$	5.8mH $\pm 30\%$	0.2	0.03	5.9	0.98	18.0	662	53.0	317	120
PCA14.5/6ER-U02S002	78.4 $\pm 30\%$	2.8mH $\pm 30\%$	0.3	0.04	7.9	1.32	9.8	356	37.0	222	103
PCA14.5/6ER-U03S002	21.6 $\pm 20\%$	778 $\pm 20\%$	3.1	0.52	5.9	0.98	18.0	662	53.0	317	120
PCA14.5/6ER-U04S002	10.6 $\pm 20\%$	381 $\pm 20\%$	4.8	0.80	7.9	1.32	9.8	356	37.0	222	103
PCA14.5/6ER-U05S002	11.6 $\pm 20\%$	418 $\pm 20\%$	6.5	1.08	5.9	0.98	18.0	662	53.0	317	120
PCA14.5/6ER-U06S002	5.7 $\pm 20\%$	205 $\pm 20\%$	8.8	1.46	7.9	1.32	9.8	356	37.0	222	103
PCA14.5/6ER-U07S002	8.3 $\pm 20\%$	299 $\pm 20\%$	9.6	1.60	5.9	0.98	18.0	662	53.0	317	120
PCA14.5/6ER-U08S002	4.1 $\pm 20\%$	146 $\pm 20\%$	14.3	2.38	7.9	1.32	9.8	356	37.0	222	103
PCA14.5/6ER-U09S002	6.6 $\pm 20\%$	238 $\pm 20\%$	12.5	2.08	5.9	0.98	18.0	662	53.0	317	120
PCA14.5/6ER-U10S002	3.2 $\pm 20\%$	116 $\pm 20\%$	17.5	2.92	7.9	1.32	9.8	356	37.0	222	103

Electrical Specifications @23°C

*1 Idc 1 = Depend on inductance saturation. (30% below the initial value).

*2 Idc 2 = Depend on self temperature rise. (Temperature increase of 40°C).

*3 Parallel = 6 coils connected in parallel.

*4 Series = 6 coils connected in series.

PCA series

PCA15EFD Type

SHAPE & DIMENSIONS

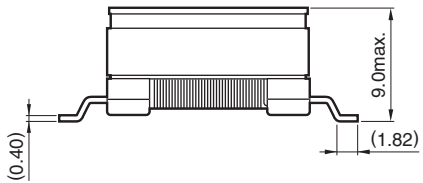
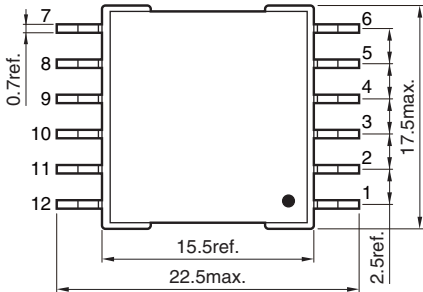

Dimensions in mm

RECOMMENDED LAND PATTERN

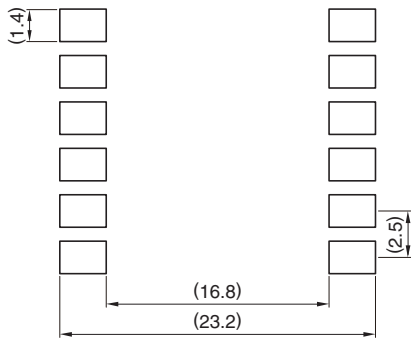

Suggested PCB layout

Dimensions in mm

CIRCUIT DIAGRAM

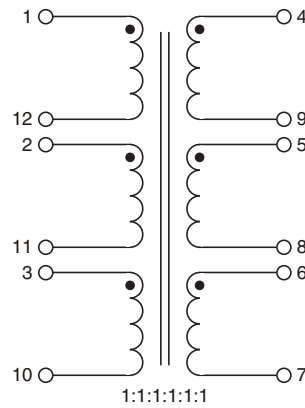

• All specifications are subject to change without notice.

PCA series PCA15EFD Type

■ ELECTRICAL CHARACTERISTICS

□ CHARACTERISTICS SPECIFICATION TABLE

Part No.	Inductance (μ H) @10KHz,0.1Vrms		Idc 1*1 (Amps) Typ.		Idc 2*2 (Amps) Typ.		DCR (m Ω) \pm 15%		ET Constant (V- μ S) max.		Leakage Inductance (nH)Typ.
	Parallel*3	Series*4	Parallel*3	Series*4	Parallel*3	Series*4	Parallel*3	Series*4	Parallel*3	Series*4	Single
PCA15EFD-U01S003	169.0 \pm 30%	6.1mH \pm 30%	0.1	0.02	6.4	1.07	12.9	466	47.4	284	117
PCA15EFD-U02S002	81.0 \pm 30%	2.9mH \pm 30%	0.2	0.04	8.0	1.34	8.9	323	32.8	197	98
PCA15EFD-U03S003	23.3 \pm 20%	840 \pm 20%	2.8	0.46	6.4	1.07	12.9	466	47.4	284	117
PCA15EFD-U04S002	11.2 \pm 20%	402 \pm 20%	3.8	0.64	8.0	1.34	8.9	323	32.8	197	98
PCA15EFD-U05S003	14.2 \pm 20%	511 \pm 20%	4.3	0.72	6.4	1.07	12.9	466	47.4	284	117
PCA15EFD-U06S002	6.8 \pm 20%	245 \pm 20%	7.1	1.19	8.0	1.34	8.9	323	32.8	197	98
PCA15EFD-U07S003	9.3 \pm 20%	335 \pm 20%	7.6	1.27	6.4	1.07	12.9	466	47.4	284	117
PCA15EFD-U08S002	4.5 \pm 20%	160 \pm 20%	11.3	1.88	8.0	1.34	8.9	323	32.8	197	98
PCA15EFD-U09S003	7.9 \pm 20%	286 \pm 20%	9.1	1.51	6.4	1.07	12.9	466	47.4	284	117
PCA15EFD-U10S002	3.8 \pm 20%	137 \pm 20%	13.4	2.23	8.0	1.34	8.9	323	32.8	197	98

Electrical Specifications @23°C

*1 Idc 1 = Depend on inductance saturation. (30% below the initial value).

*2 Idc 2 = Depend on self temperature rise. (Temperature increase of 40°C).

*3 Parallel = 6 coils connected in parallel.

*4 Series = 6 coils connected in series.

PCA series

PCA20EFD Type

SHAPE & DIMENSIONS



Dimensions in mm

RECOMMENDED LAND PATTERN



Suggested PCB layout

Dimensions in mm

CIRCUIT DIAGRAM



• All specifications are subject to change without notice.

PCA series PCA20EFD Type

ELECTRICAL CHARACTERISTICS

CHARACTERISTICS SPECIFICATION TABLE

Part No.	Inductance (μ H) @10KHz,0.1Vrms		Idc 1 ^{*1} (Amps) Typ.		Idc 2 ^{*2} (Amps) Typ.		DCR (m Ω) \pm 15%		ET Constant (V- μ S) max.		Leakage Inductance (nH)Typ.
	Parallel ^{*3}	Series ^{*4}	Parallel ^{*3}	Series ^{*4}	Parallel ^{*3}	Series ^{*4}	Parallel ^{*3}	Series ^{*4}	Parallel ^{*3}	Series ^{*4}	Single
PCA20EFD-U01S003	197.3 \pm 30%	7.1mH \pm 30%	0.2	0.03	9.6	1.6	7.9	285	102	610	160
PCA20EFD-U02S002	87.7 \pm 30%	3.2mH \pm 30%	0.3	0.06	12.0	2.0	5.2	188	68	407	109
PCA20EFD-U03S003	22.3 \pm 20%	804 \pm 20%	6.7	1.11	9.6	1.6	7.9	285	102	610	160
PCA20EFD-U04S002	9.9 \pm 20%	357 \pm 20%	8.6	1.43	12.0	2.0	5.2	188	68	407	109
PCA20EFD-U05S003	12.0 \pm 20%	430 \pm 20%	10.9	1.82	9.6	1.6	7.9	285	102	610	160
PCA20EFD-U06S002	5.3 \pm 20%	191 \pm 20%	16.1	2.68	12.0	2.0	5.2	188	68	407	109
PCA20EFD-U07S003	9.6 \pm 20%	347 \pm 20%	13.3	2.21	9.6	1.6	7.9	285	102	610	160
PCA20EFD-U08S002	4.3 \pm 20%	154 \pm 20%	20.5	3.42	12.0	2.0	5.2	188	68	407	109
PCA20EFD-U09S003	7.6 \pm 20%	275 \pm 20%	17.2	2.86	9.6	1.6	7.9	285	102	610	160
PCA20EFD-U10S002	3.4 \pm 20%	122 \pm 20%	26.2	4.36	12.0	2.0	5.2	188	68	407	109

Electrical Specifications @23°C

*1 Idc 1 = Depend on inductance saturation. (30% below the initial value).

*2 Idc 2 = Depend on self temperature rise. (Temperature increase of 40°C).

*3 Parallel 6 coils connected in parallel.

*4 Series 6 coils connected in series.

PCA series

Packaging style

REEL DIMENSIONS

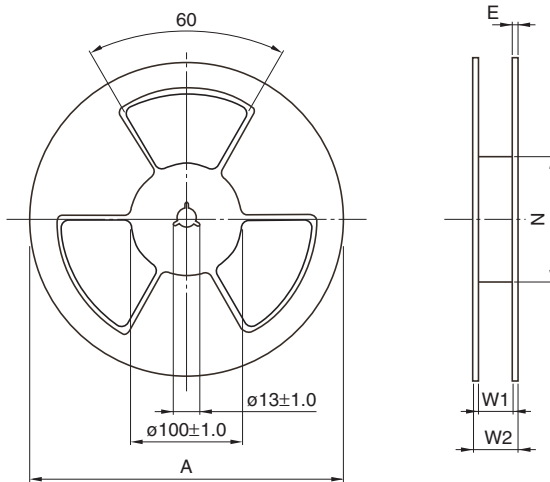

Dimensions in mm

Type	A	W1	W2	N	E
PCA11/5ER	ø330	24.5	28.5	ø99.4	2
PCA14.5/6ER	ø330	24.5	28.5	ø99.4	2
PCA15EFD	ø330	44.5	48.5	ø100	2
PCA20EFD	ø330	44.5	48.5	ø100	2

* These values are typical values.

TAPE DIMENSIONS

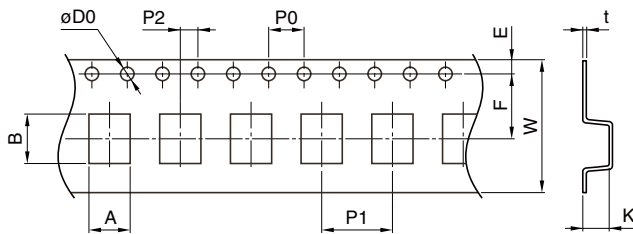

Dimensions in mm

Type	A	B	øD0	E	F	P0	P1	P2	W	K	t
PCA11/5ER	12.3±0.1	13.8±0.1	1.5±0.1	1.75±0.1	11.5±0.1	4.0±0.1	16.0±0.1	2.0±0.1	24.0±0.3	6.85±0.1	0.35±0.03
PCA14.5/6ER	15.3±0.1	17.0±0.1	1.5±0.1	1.75±0.1	11.5±0.1	4.0±0.1	24.0±0.1	2.0±0.1	24.0±0.3	7.4±0.2	0.50±0.05
PCA15EFD	17.3±0.1	24.0±0.1	1.5±0.1	1.75±0.1	20.2±0.1	4.0±0.1	24.0±0.1	2.0±0.1	44.0±0.3	8.8±0.1	0.50±0.05
PCA20EFD	21.4±0.1	31.0±0.1	1.5±0.1	1.75±0.1	20.2±0.1	4.0±0.1	28.0±0.1	2.0±0.1	44.0±0.3	11.1±0.1	0.50±0.05

• All specifications are subject to change without notice.



Компания «ЭлектроПласт» предлагает заключение долгосрочных отношений при поставках импортных электронных компонентов на взаимовыгодных условиях!

Наши преимущества:

- Оперативные поставки широкого спектра электронных компонентов отечественного и импортного производства напрямую от производителей и с крупнейших мировых складов;
- Поставка более 17-ти миллионов наименований электронных компонентов;
- Поставка сложных, дефицитных, либо снятых с производства позиций;
- Оперативные сроки поставки под заказ (от 5 рабочих дней);
- Экспресс доставка в любую точку России;
- Техническая поддержка проекта, помощь в подборе аналогов, поставка прототипов;
- Система менеджмента качества сертифицирована по Международному стандарту ISO 9001;
- Лицензия ФСБ на осуществление работ с использованием сведений, составляющих государственную тайну;
- Поставка специализированных компонентов (Xilinx, Altera, Analog Devices, Intersil, Interpoint, Microsemi, Aeroflex, Peregrine, Syfer, Eurofarad, Texas Instrument, Miteq, Cobham, E2V, MA-COM, Hittite, Mini-Circuits, General Dynamics и др.);

Помимо этого, одним из направлений компании «ЭлектроПласт» является направление «Источники питания». Мы предлагаем Вам помощь Конструкторского отдела:

- Подбор оптимального решения, техническое обоснование при выборе компонента;
- Подбор аналогов;
- Консультации по применению компонента;
- Поставка образцов и прототипов;
- Техническая поддержка проекта;
- Защита от снятия компонента с производства.



Как с нами связаться

Телефон: 8 (812) 309 58 32 (многоканальный)

Факс: 8 (812) 320-02-42

Электронная почта: org@eplast1.ru

Адрес: 198099, г. Санкт-Петербург, ул. Калинина, дом 2, корпус 4, литера А.