



FEATURES

- Patent Pending
- Footprint over pins 0.69cm²
- Single & dual isolated output
- 1kVDC Isolation
- Efficiency up to 88% (Typ.)
- MSL Level 1
- Power density 1.71W/cm³
- Wide temperature performance at full 1 Watt load, -40°C to 85°C
- UL 94V-0 Package material
- 3.3V, 5V & 12V Input
- 5V, 9V, 12V & 15V single & dual outputs
- Toroidal magnetics
- Custom solutions available
- Multi-layer ceramic capacitors

PRODUCT OVERVIEW

The MTU1 series is a new range of miniature surface mount, high performance 1W DC/DC converters. With a footprint reduction of over 50% from the previous generation of 1W SMD DC/DC, the MTU1 series offers 1W of available output power over the full industrial temperature range of -40°C to 85°C. The MTU1 series is more efficient and offers improved regulation performance for applications where a wide output voltage variation can not be tolerated.

The devices are suitable for all applications where high volume production is envisaged.



SELECTION GUIDE

Order Code ¹	Nominal Input Voltage	Output Voltage	Output Current	Load Regulation (Typ.)	Load Regulation (Max)	Ripple & Noise (Typ.) ³	Ripple & Noise (Max.) ³	Input Current at Full Load	Efficiency (Min.)	Efficiency (Typ.)	Isolation Capacitance	MTTF ²
	V	V	mA	%	%	mVp-p	mVp-p	mA	%	%	pF	kHrs
MTU1S0305MC	3.3	5	200	8.9	11.0	26	60	367	79	81	14	7660
MTU1S0505MC	5	5	200	7.3	9	35	60	241	80	83	19	5664
MTU1S0509MC	5	9	111	6.1	7.5	15	25	233	83	86	20	5488
MTU1S0512MC	5	12	83	5.6	7.5	15	25	230	84	87	21	5186
MTU1S0515MC	5	15	67	5.3	6.5	15	25	230	84	87	22	4773
MTU1S1205MC	12	5	200	5.6	8	20	40	99	80	84	22	5641
MTU1S1209MC	12	9	111	3.9	6	15	25	96	82	87	31	5467
MTU1S1212MC	12	12	83	3.5	6	10	25	95	83	88	40	5165
MTU1S1215MC	12	15	67	3.2	5	10	25	95	84	88	35	4753
MTU1D0305MC	3.3	±5	±100	8.0	9.5	18	35	356	80	83	17	5292
MTU1D0505MC	5	±5	±100	6.6	8	14	30	235	81	84	18	5053
MTU1D0509MC	5	±9	±56	5.6	6.5	7	20	229	83	86	21	5078
MTU1D0512MC	5	±12	±42	5.0	6	8	20	228	83	87	19	5545
MTU1D0515MC	5	±15	±33	5.1	6.5	8	20	224	84	88	22	5293
MTU1D1205MC	12	±5	±100	4.3	5	14	30	98	80	85	18	4335
MTU1D1209MC	12	±9	±56	3.1	4	7	20	95	82	87	27	4601
MTU1D1212MC	12	±12	±42	3.0	4	8	20	94	84	88	35	4834
MTU1D1215MC	12	±15	±33	2.6	3.5	8	20	94	84	88	35	4782

INPUT CHARACTERISTICS

Parameter	Conditions	Min.	Typ.	Max.	Units
Voltage range	Continuous operation, 3.3V input types	2.97	3.3	3.63	V
	Continuous operation, 5V input types	4.5	5.0	5.5	
	Continuous operation, 12V input types	10.8	12.0	13.2	
Reflected ripple current	Single output types	3.3V input types	10		mA p-p
		5V input types	6		
		12V input types	5		
	Dual output types	All variants	5		

ISOLATION CHARACTERISTICS

Parameter	Conditions	Min.	Typ.	Max.	Units
Isolation voltage	Flash tested for 1 second	1000			VDC
Resistance	Viso= 1000VDC	10			GΩ

GENERAL CHARACTERISTICS

Parameter	Conditions	Min.	Typ.	Max.	Units
Switching frequency	MTU1D0305MC		70		kHz
	3.3V & 5V input, all output types (except MTU1D0305MC)		82		
	12V input, single output types		90		
	12V input, dual output types		100		

OUTPUT CHARACTERISTICS

Parameter	Conditions	Min.	Typ.	Max.	Units
Rated power	T _A =-40°C to 85°C			1.0	W
Voltage set point accuracy	See tolerance envelope				
Line regulation	High V _{in} to low V _{in}		1.0	1.1	%/%

1. If components are required in tape and reel format suffix order code with -R, e.g. MTU10505MC-R.

2. Calculated using MIL-HDBK-217 FN2 calculation model with nominal input voltage at full load.

3. See ripple & noise characterisation method.

All specifications typical at T_A=25°C, nominal input voltage and rated output current unless otherwise specified.

ABSOLUTE MAXIMUM RATINGS

Input voltage V_{IN} , MTU1S03 types	5.5V
Input voltage V_{IN} , MTU1S05 types	7V
Input voltage V_{IN} , MTU1S12 types	15V

TEMPERATURE CHARACTERISTICS

Parameter	Conditions	Min.	Typ.	Max.	Units
Specification	All output types	-40		85	°C
Storage		-55		125	
Case temperature rise above ambient ⁴	MTU1xxx05MC		15		
	MTU1xxx09MC		14		
	MTU1xxx12MC & MTU1xxx15MC		11		
Cooling	Free air convection				

4. Measured after 1 hour continuous operation at nominal V_{IN} full load at the center of each PCB.

TECHNICAL NOTES

ISOLATION VOLTAGE

'Hi Pot Test', 'Flash Tested', 'Withstand Voltage', 'Proof Voltage', 'Dielectric Withstand Voltage' & 'Isolation Test Voltage' are all terms that relate to the same thing, a test voltage, applied for a specified time, across a component designed to provide electrical isolation, to verify the integrity of that isolation.

Murata Power Solutions MTU1 series of DC/DC converters are all 100% production tested at their stated isolation voltage. This is 1kVDC for 1 second.

A question commonly asked is, "What is the continuous voltage that can be applied across the part in normal operation?"

For a part holding no specific agency approvals, such as the MTU1 series, both input and output should normally be maintained within SELV limits i.e. less than 42.4V peak, or 60VDC. The isolation test voltage represents a measure of immunity to transient voltages and the part should never be used as an element of a safety isolation system. The part could be expected to function correctly with several hundred volts offset applied continuously across the isolation barrier; but then the circuitry on both sides of the barrier must be regarded as operating at an unsafe voltage and further isolation/insulation systems must form a barrier between these circuits and any user-accessible circuitry according to safety standard requirements.

REPEATED HIGH-VOLTAGE ISOLATION TESTING

It is well known that repeated high-voltage isolation testing of a barrier component can actually degrade isolation capability, to a lesser or greater degree depending on materials, construction and environment. The MTU1 series has toroidal isolation transformers, with no additional insulation between primary and secondary windings of enameled wire. While parts can be expected to withstand several times the stated test voltage, the isolation capability does depend on the wire insulation. Any material, including this enamel (typically polyurethane) is susceptible to eventual chemical degradation when subject to very high applied voltages thus implying that the number of tests should be strictly limited. We therefore strongly advise against repeated high voltage isolation testing, but if it is absolutely required, that the voltage be reduced by 20% from specified test voltage.

This consideration equally applies to agency recognized parts rated for better than functional isolation where the wire enamel insulation is always supplemented by a further insulation system of physical spacing or barriers.

TEMPERATURE DERATING GRAPH

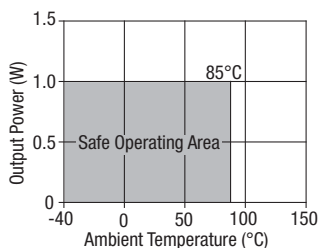

RoHS COMPLIANCE INFORMATION



This series is compatible with RoHS soldering systems with a peak reflow solder temperature of 245°C as per J-STD-020D.1.

The pin termination finish on this product series is Matte Tin over Nickel Preplate. The series is backward compatible with Sn/Pb soldering systems. The series has a Moisture Sensitivity Level (MSL) 1.

Samples of the product series were tested in accordance with the conditioning described for MSL level 1 in IPS/J-STD-020D.1.

The product series passed electrical tests and visual inspection criteria.

For further information, please visit: www.murata-ps.com/rohs

TOLERANCE ENVELOPES

3.3V Input Types

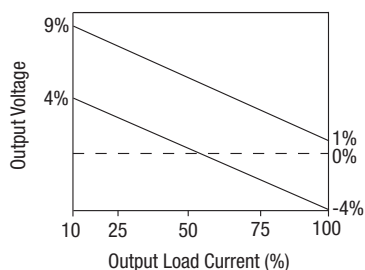

Single 5V output types (except 3.3V input)

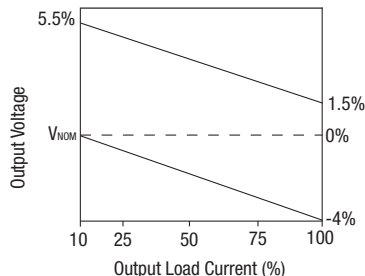

Dual 5V Output types (except 3.3V input)

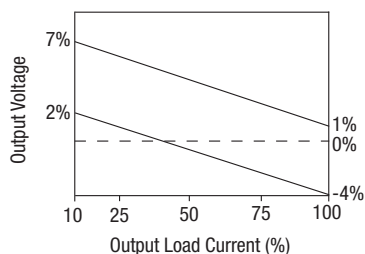

All other types

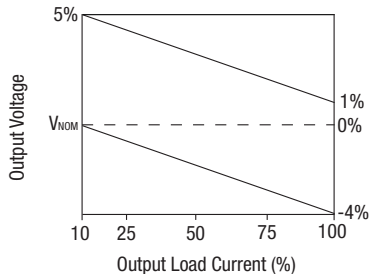

The voltage tolerance envelope shows typical load regulation characteristics for this product series. The tolerance envelope is the maximum output voltage variation due to changes in output loading and set point accuracy.

APPLICATION NOTES

Minimum load

The minimum load to meet datasheet specification is 10% of the full rated load across the specified input voltage range. Lower than 10% minimum loading will result in an increase in output voltage, which may rise to typically double the specified output voltage if the output load falls to less than 5%.

Capacitive loading and start up

Typical start up times for this series, with a typical input voltage rise time of 2.2µs and output capacitance of 10µF, are shown in the table below. The product series will start into a capacitance of 47µF with an increased start time, however, the maximum recommended output capacitance is 10µF.

	Start-up time ms		Start-up time ms
MTU1S0305MC	1.7	MTU1D0305MC	3.1
MTU1S0505MC	0.9	MTU1D0505MC	1.8
MTU1S0509MC	2.7	MTU1D0509MC	5.7
MTU1S0512MC	4.3	MTU1D0512MC	10.1
MTU1S0515MC	7.5	MTU1D0515MC	19.1
MTU1S1205MC	0.9	MTU1D1205MC	1.5
MTU1S1209MC	1.9	MTU1D1209MC	4
MTU1S1212MC	3.3	MTU1D1212MC	7.5
MTU1S1215MC	4.7	MTU1D1215MC	12.5

Typical Start-Up Wave Form

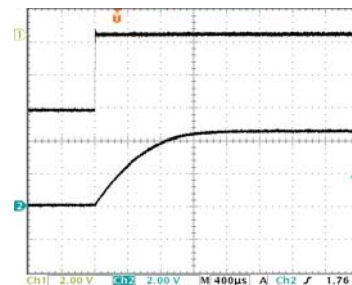

Ripple & Noise Characterisation Method

Ripple and noise measurements are performed with the following test configuration.

C1	1µF X7R multilayer ceramic capacitor, voltage rating to be a minimum of 3 times the output voltage of the DC/DC converter
C2	10µF tantalum capacitor, voltage rating to be a minimum of 1.5 times the output voltage of the DC/DC converter with an ESR of less than 100mΩ at 100 kHz
C3	100nF multilayer ceramic capacitor, general purpose
R1	450Ω resistor, carbon film, ±1% tolerance
R2	50Ω BNC termination
T1	3T of the coax cable through a ferrite toroid
RLOAD	Resistive load to the maximum power rating of the DC/DC converter. Connections should be made via twisted wires

Measured values are multiplied by 10 to obtain the specified values.

Differential Mode Noise Test Schematic

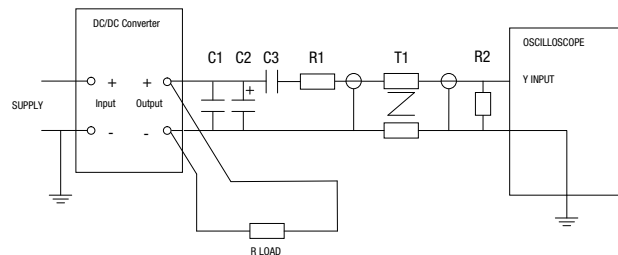

EFFICIENCY VS LOAD

MTU1x03xxMC

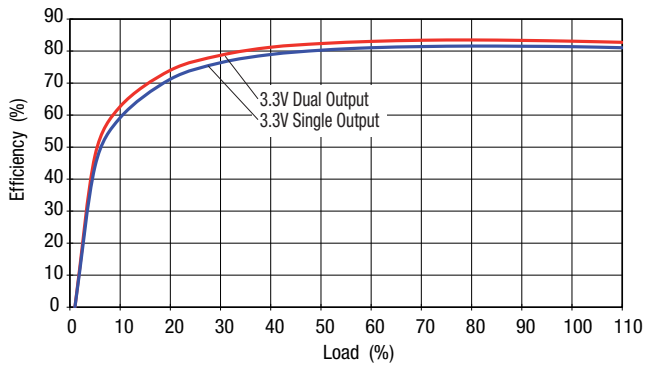

MTUx05xxMC

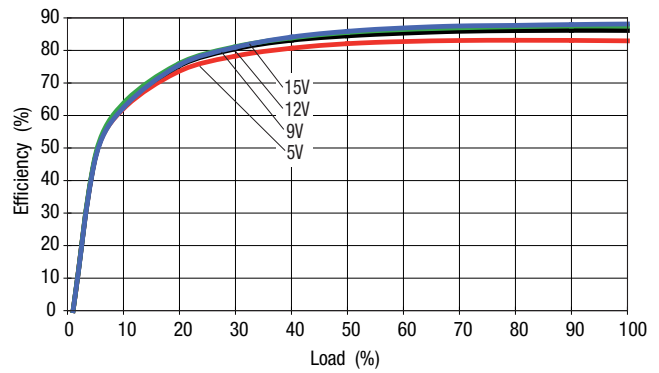

MTU1x12xxMC

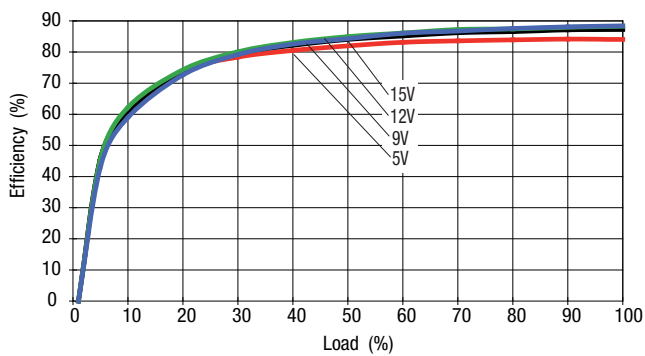

PACKAGE SPECIFICATIONS

MECHANICAL DIMENSIONS - Patent Pending

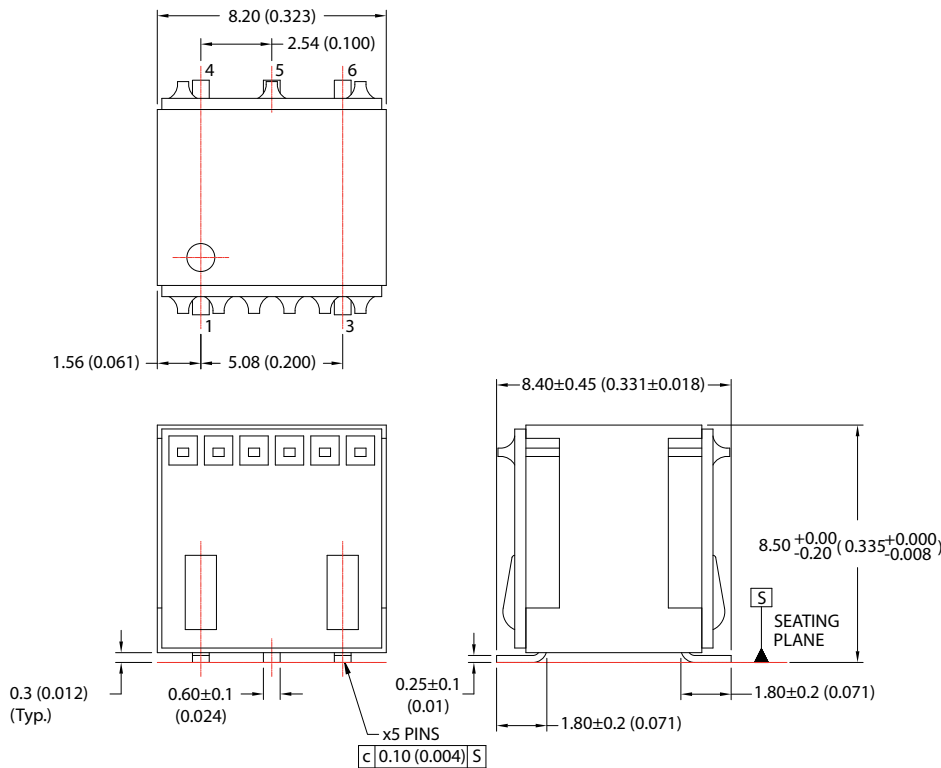

All dimensions in mm ± 0.25 mm (inches ± 0.01). All pins on a 2.54 (0.1) pitch and within 0.25 (0.01) of true position.

Weight: 0.75g, typ.

PIN CONNECTIONS

Single Output Types

Pin	Function
1	+V _{IN}
3	-V _{IN}
4	+V _{OUT}
5	OV
6	NC

Dual Output Types

Pin	Function
1	+V _{IN}
3	-V _{IN}
4	+V _{OUT}
5	OV
6	-V _{OUT}

RECOMMENDED FOOTPRINT DETAILS

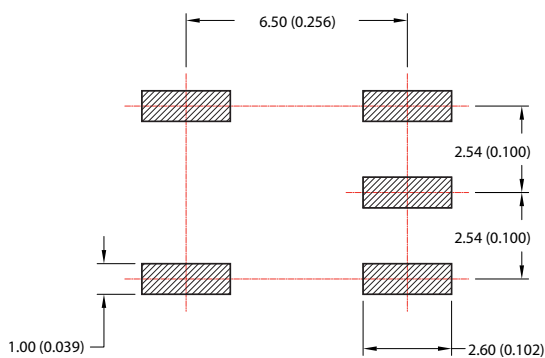

TUBE OUTLINE DIMENSIONS

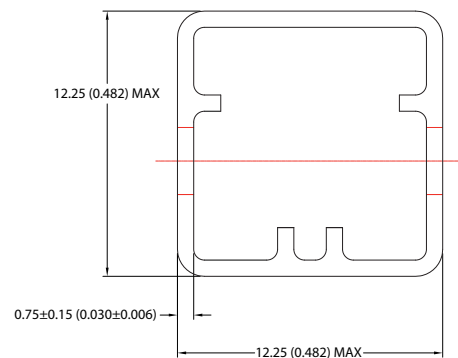

Unless otherwise stated all dimensions in mm ± 0.25 mm (inches).
Tube length: 520mm ± 2.00

Tube Quantity: 60

TAPE & REEL SPECIFICATIONS

REEL OUTLINE DIMENSIONS

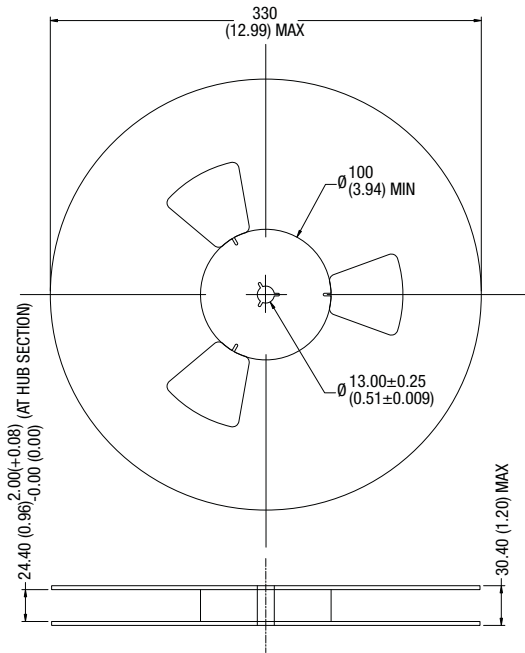

TAPE OUTLINE DIMENSIONS

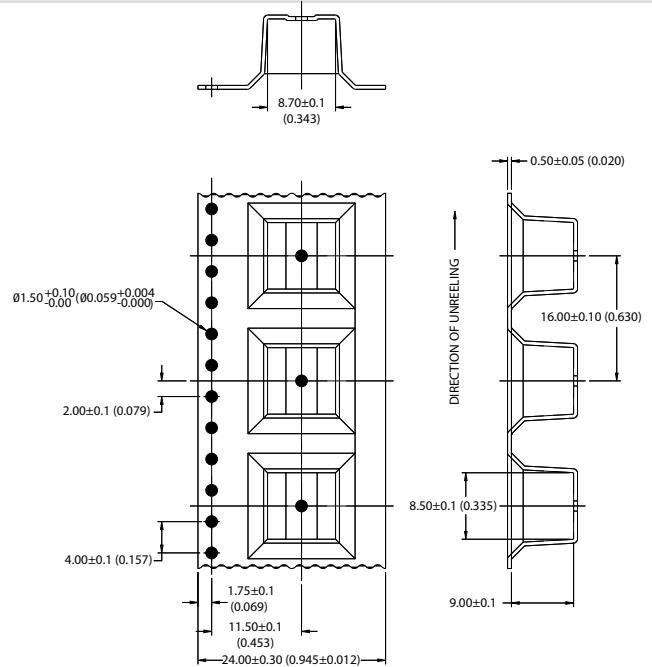

REEL PACKAGING DETAILS

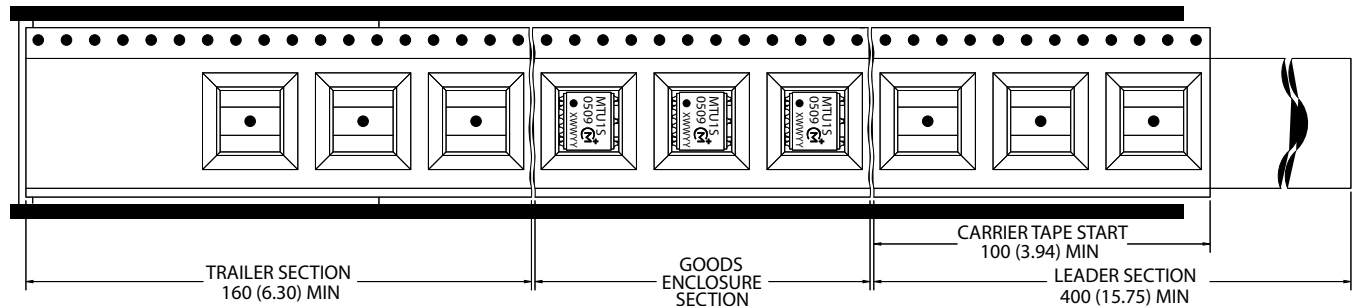

Product Orientation
Pin 1, located nearest to carrier drive sprocket.

Reel Quantity: 400 pcs.

Murata Power Solutions, Inc.
11 Cabot Boulevard, Mansfield, MA 02048-1151 U.S.A.
ISO 9001 and 14001 REGISTERED



This product is subject to the following **operating requirements** and the **Life and Safety Critical Application Sales Policy**:
Refer to: <http://www.murata-ps.com/requirements/>

Murata Power Solutions, Inc. makes no representation that the use of its products in the circuits described herein, or the use of other technical information contained herein, will not infringe upon existing or future patent rights. The descriptions contained herein do not imply the granting of licenses to make, use, or sell equipment constructed in accordance therewith. Specifications are subject to change without notice. © 2012 Murata Power Solutions, Inc.



Компания «ЭлектроПласт» предлагает заключение долгосрочных отношений при поставках импортных электронных компонентов на взаимовыгодных условиях!

Наши преимущества:

- Оперативные поставки широкого спектра электронных компонентов отечественного и импортного производства напрямую от производителей и с крупнейших мировых складов;
- Поставка более 17-ти миллионов наименований электронных компонентов;
- Поставка сложных, дефицитных, либо снятых с производства позиций;
- Оперативные сроки поставки под заказ (от 5 рабочих дней);
- Экспресс доставка в любую точку России;
- Техническая поддержка проекта, помощь в подборе аналогов, поставка прототипов;
- Система менеджмента качества сертифицирована по Международному стандарту ISO 9001;
- Лицензия ФСБ на осуществление работ с использованием сведений, составляющих государственную тайну;
- Поставка специализированных компонентов (Xilinx, Altera, Analog Devices, Intersil, Interpoint, Microsemi, Aeroflex, Peregrine, Syfer, Eurofarad, Texas Instrument, Miteq, Cobham, E2V, MA-COM, Hittite, Mini-Circuits, General Dynamics и др.);

Помимо этого, одним из направлений компании «ЭлектроПласт» является направление «Источники питания». Мы предлагаем Вам помощь Конструкторского отдела:

- Подбор оптимального решения, техническое обоснование при выборе компонента;
- Подбор аналогов;
- Консультации по применению компонента;
- Поставка образцов и прототипов;
- Техническая поддержка проекта;
- Защита от снятия компонента с производства.



Как с нами связаться

Телефон: 8 (812) 309 58 32 (многоканальный)

Факс: 8 (812) 320-02-42

Электронная почта: org@eplast1.ru

Адрес: 198099, г. Санкт-Петербург, ул. Калинина, дом 2, корпус 4, литера А.