



IQS228AS Datasheet

IQ Switch® - ProxSense® Series

Single Channel Capacitive Proximity/Touch Controller

The ProxSense® **IQS228AS** is a single channel self-capacitive sensor with Dynamic Calibration (DYCAL™) to allow for sensor drift during prolonged activation.

Features

- 1 Self capacitive channel
- DYCAL™: Intelligent Hysteresis
- Proximity and Touch outputs
- Automatic Tuning
- Internal Reference Capacitor

- Minimum external components
- 1-Wire data streaming
- I²C Debug option
- User selectable options (OTP):
 - Ext sync control or Ext filter control
 - I/O Sink or Source selection
 - Time-out for stuck key
 - Proximity and Touch sensitivity selections
 - Low Power modes
- Low power mode 2.5µA
- Supply voltage: 1.8V to 3.6V

RoHS2
Compliant

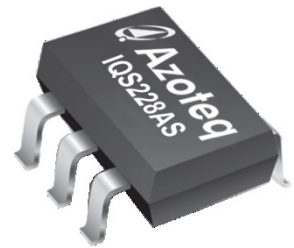

6 pin TSOT23-6
Representations only,
not actual markings

Applications

- Proximity sensors
- SAR detection for Tablets
- On-ear detection for mobile phones
- 3D glasses
- Personal Media Players
- White goods and appliances
- Human Interface Devices
- Proximity activated backlighting

Available Options

T_A	TSOT23-6
-20°C to 85°C	IQS228AS



Contents

1 OVERVIEW4

2 PACKAGING AND PIN-OUT5

3 USER CONFIGURABLE OPTIONS.....7

4 MEASURING CAPACITANCE USING THE *CHARGE TRANSFER* METHOD.....10

5 DYCAL™ OPERATION11

6 OPERATING PRINCIPLE12

7 CONFIGURABLE SETTINGS12

8 STREAMING MODE.....15

9 AUTO TUNING IMPLEMENTATION (ATI)16

10 DYCAL SPECIFIC SETTINGS18

11 ELECTRICAL SPECIFICATIONS19

12 DATASHEET AND PART-NUMBER INFORMATION23

13 REVISION HISTORY25

APPENDIX A. MEMORY MAP26

APPENDIX B. ERRATA29



List of Abbreviations

ATI	Automatic Tuning Implementation
BP	Boost Power Mode
CS	Counts (Number of Charge Transfers)
C _s	Internal Reference Capacitor
DYCAL™	Dynamic Calibration
EMI	Electromagnetic Interference
ESD	Electro-Static Discharge
FTB/EFT	(Electrical) Fast Transient Bursts
GND	Ground
HC	Halt Charge
LP	Low Power Mode
LTA	Long Term Average
ND	Noise Detect
THR	Threshold
TM	Touch Mode



1 Overview

1.1 Device

The IQS228AS is a single channel capacitive proximity and touch device which employs an internal voltage regulator and reference capacitor (C_s).

The IQS228AS device has a dedicated pin(s) for the connection of a sense electrode(s) (C_x) and output pin(s) for proximity and touch events on OUT. The polarity of the output pins can be configured. A 1-wire open drain data streaming protocol OR I²C interface is implemented for debugging purposes.

Special device configuration can be done by setting one time programmable (OTP) options.

The device automatically tracks slow varying environmental changes via various signal processing algorithms and has an Automatic Tuning Implementation (ATI) algorithm to calibrate the device to the sense electrode.

DYCAL™ (Dynamic Calibration) is a special form of hysteresis that can track slow varying environmental change even while the sensor is in a touch state. This is ideal for portable applications.

The *charge transfer* method of capacitive sensing is employed on the IQS228AS. (The charge transfer principle is thoroughly described in the application note: “AZD004 - Azoteq Capacitive Sensing”.)

1.2 Operation

The device has been designed to be used in applications where proximity is required and touch conditions can prevail for an extended period of time which may result in uncompensated drift in conventional capacitive sensors.

A low threshold is used to detect the proximity of an object, with a higher threshold for touch detection.

Dynamic Calibration is performed when a TOUCH condition is detected for longer than t_{DYCAL} . The hysteresis algorithm will now check for the release condition of the touch, while still tracking environmental changes

1.3 Applicability

All specifications, except where specifically mentioned otherwise, provided by this datasheet are applicable to the following ranges:

- Temperature: -20C to +85C
- Supply voltage (V_{DDHI}): 1.8V to 3.6V

2 Packaging and Pin-Out

The IQS228AS is available in a TSOT23-6 package.

2.1 IQS228AS

2.1.1 Pin-out TSOT23-6

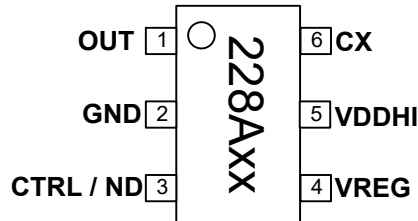

Figure 2.1 Pin-out of IQS228AS in the TSOT23-6 package.

Table 2.1 Pin-out description

IQS228AS in TSOT23-6			
Pin	Name	Type	Function
1	OUT	Digital Out	Output
2	GND	Ground	GND Reference
3	CTRL / ND	Digital Input/Output	Control input or proximity output / ND pin
4	VREG	Analogue Output	Internal Regulator Pin (Connect 1µF bypass capacitor)
5	VDDHI	Supply Input	Supply Voltage Input
6	CX	Analogue	Sense Electrode

2.1.2 Schematic

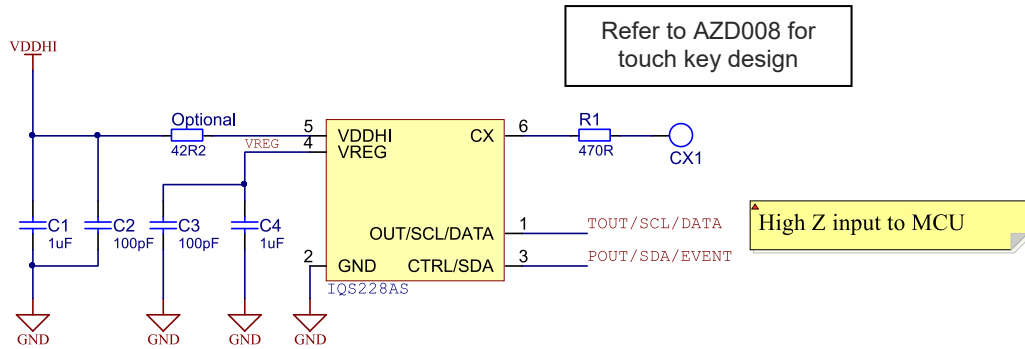

Figure 2.2 Typical application reference schematic of IQS228AS. C2 & C3 are optional for added RF immunity.

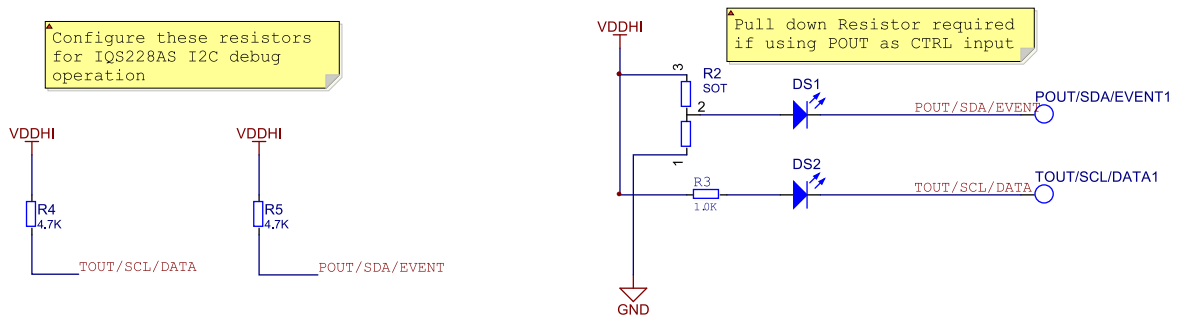

Figure 2.3 IQS228AS output pin configuration for I2C debug operation, or driving LEDs (active high or low option available).

Where a system level ESD strike is found to cause the IC to go into ESD induced latch-up, it is suggested that the supply current to the IQSXXX IC is limited by means of a series resistor that could limit the maximum supply current to the IC to <80mA.



3 User Configurable Options

This section lists the user configurable settings.

The device is fully functional in its default state, but some applications may require alternative configuration settings. These settings are enabled by configuring One Time Programmable (OTP) user options.

Configuration can be done on packaged devices or in-circuit. In-circuit configuration may be limited by values of external components chosen.

Popular configurations are available ex-stock – please check with the local distributor for availability. Azoteq can

supply pre-configured devices for large quantities.

3.1 Configuring Devices

Azoteq offers a Configuration Tool (CT210/20) and accompanying software (USBProg.exe) that can be used to program the OTP user options for prototyping purposes. More details regarding the configuration of the device with the USBProg program is explained by application note: “AZD007 – USBProg Overview” which can be found on the Azoteq website.

Alternative programming solutions for the IQS228AS also exist. For further enquiries regarding this, please contact Azoteq at ProxSenseSupport@azoteq.com or the local distributor

3.1.1 IQS228AS User Selectable Options

Table 3.1 IQS228AS Bank 0 User Selectable Options (0xC4H)

Bit	7	6	5	4	3	2	1	0
Name	IN_EN	REL _{THR}	LOGIC	T _{THR2}	T _{THR1}	T _{THR0}	P _{THR1}	P _{THR0}
bit 7	IN_EN: Input Enable 0 = Output (Proximity) 1 = Input						Section 10.2	
bit 6	REL_{THR}: Release Threshold 0 = 75% 1 = 87%						Section 10.1	
bit 5	LOGIC: Output logic select (Only when STREAMING mode is disabled) 0 = Software Open Drain Active Low 1 = Active High						Section 7.2	
bit 4-2	T_{THR}: Touch Threshold Selections 000 = 72/256 001 = 4/256 010 = 8/256 011 = 24/256 100 = 48/256 101 = 96/256 110 = 128/256 111 = 160/256						Section 7.5	
bit 1-0	P_{THR}: Proximity Threshold Selections 00 = 4 01 = 2 10 = 8 11 = 16						Section 7.4	

**Table 3.2 User Selectable Configuration Options: Bank 1 – Full ATI (0xC5H)**

t_{HALT1}	t_{HALT0}	~	~	TURBO	BASE ₂	BASE ₁	BASE ₀
bit 7				bit 0			
Bank1: bit 7-6		t_{HALT} : Halt times 00 = 20 seconds 01 = 40 seconds 10 = Never 11 = 3 seconds		Section 7.11			
Bank1: bit 5-4		Not used					
Bank1: bit 3		TURBO : DYCAL TURBO 0 = Disabled 1 = Enabled		Section 7.10			
Bank1: bit 2-0		BASE : Base Value 000 = 200 001 = 50 010 = 75 011 = 100 100 = 150 101 = 250 110 = 300 111 = 500		Section 9.3			

Table 3.3 User Selectable Configuration Options: Bank 1 – Partial ATI

t_{HALT1}	t_{HALT0}	MULT _{SENSE1}	MULT _{SENSE0}	MULT _{COMP3}	MULT _{COMP2}	MULT _{COMP1}	MULT _{COMP0}
bit 7				bit 0			
Bank1:7-6		t_{HALT} : Halt times 00 = 20 seconds 01 = 40 seconds 10 = Never 11 = 3 seconds		Section 7.11			
Bank1: bit 5-4		MULT : Multiplier for Sensitivity 00 01 10 11		Section 7.6			
Bank1: bit 3-0		MULT : Multiplier for Compensation 0000 to 1111		Section 7.6			



Table 3.4 User Selectable Configuration Options: Bank 2 (0xC6H)

STREAM	TRANS	COMMS	ND	Target	ATI	LP ₁	LP ₀	
bit 7								bit 0
Bank2: bit 7	STREAM: Steaming Method 0 = 1-wire 1 = 2-wire (I ² C)			Section 8.2				
Bank2: bit 6	TRANS: Charge Transfer Frequency 0 = 512kHz 1 = 250kHz			Section 7.7				
Bank2: bit 5	COMMS: Streaming 0 = Disabled 1 = Enabled			Section 8				
Bank2: bit 4	ND: Noise Detect 0 = Disabled 1 = Enabled (1-wire comms only)			Section 7.3				
Bank2: bit 3	Target: ATI target counts 0 = 1200 1 = 1024			Section 7.8				
Bank2: bit 2	ATI: ATI Selection 0 = Full 1 = Partial			Section 7.9				
Bank2: bit 1-0	LP: Power mode Selection 00 = BP, 9ms (64ms if zoom is disabled) 01 = NP, 128ms 10 = LP1, 256ms 11 = LP2, 512ms			Section 7.12				

Table 3.5 User Selectable Configuration Options: Bank 3 (0xC7H)

~	~	~	~	Zoom	~	~	CTRL	
bit 7								bit 0
Bank3: bit 7-4	System Use							
Bank3: bit 3	Zoom: Zoom Disable 0 = Zoom Enabled 1 = Zoom Disabled			Section 7.13				
Bank3: bit 2-1	System Use							
Bank3: bit 0	CTRL: Control Input 0 = Halt Charge 1 = Filter Halt			Section 7.1				



4 Measuring capacitance using the Charge Transfer method

The *charge transfer* method of capacitive sensing is employed on the IQS228AS. (The charge transfer principle is thoroughly described in the application note: “AZD004 - Azoteq Capacitive Sensing”.)

A charge cycle is used to take a measurement of the capacitance of the sense electrode (connected to Cx) relative to ground. It consists of a series of pulses charging Cx and discharging Cx to the reference capacitor, at the charge transfer frequency (F_{CX} - refer to Section 11). The number of the pulses required to reach a trip voltage on the reference capacitor is referred to as the **Count** value (CS) which is the instantaneous capacitive measurement. The Counts (CS) are used to determine if either a physical contact or proximity event occurred, based on the change in CS detected. The typical values of CS, without a touch or proximity condition range between 1344 and 1865 counts, although higher and lower counts can be used based on the application requirements. With CS larger than +/-1865

the gain of the system may become too high causing unsteady operation.

The IQS228AS schedules a charge cycle every t_{SAMPLE} seconds to ensure regular samples for processing of results. The duration of the charge cycle is defined as t_{CHARGE} and varies according to the counts required to reach the trip voltage. Following the charge cycle other activities such as data streaming is completed (if in streaming mode), before the next charge cycle is initiated.

Please note: Attaching a probe to the Cx pin will increase the capacitance of the sense plate and therefore C_s . This may have an immediate influence on the Counts value (decrease t_{CHARGE}) and cause a proximity or touch event. After t_{HALT} seconds the system will adjust to accommodate for this change. If the total load on Cx, with the probe attached is still lower than the maximum Cx load the system will continue to function normally after t_{HALT} seconds with the probe attached.

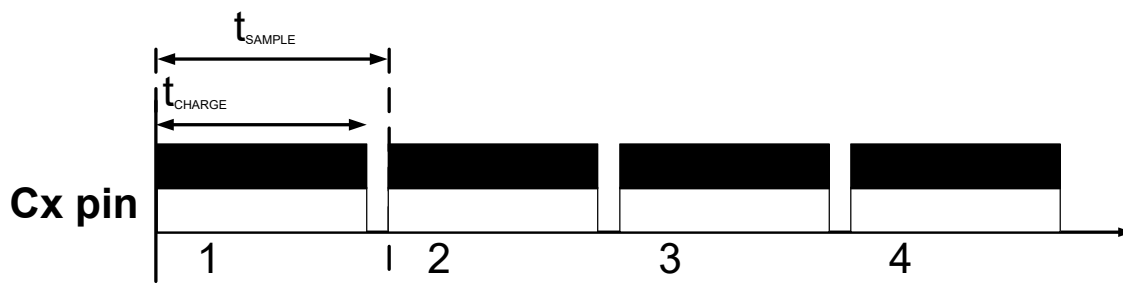

Figure 4.1 Charge cycles as can be seen on CX.



5 DYCAL™ Operation

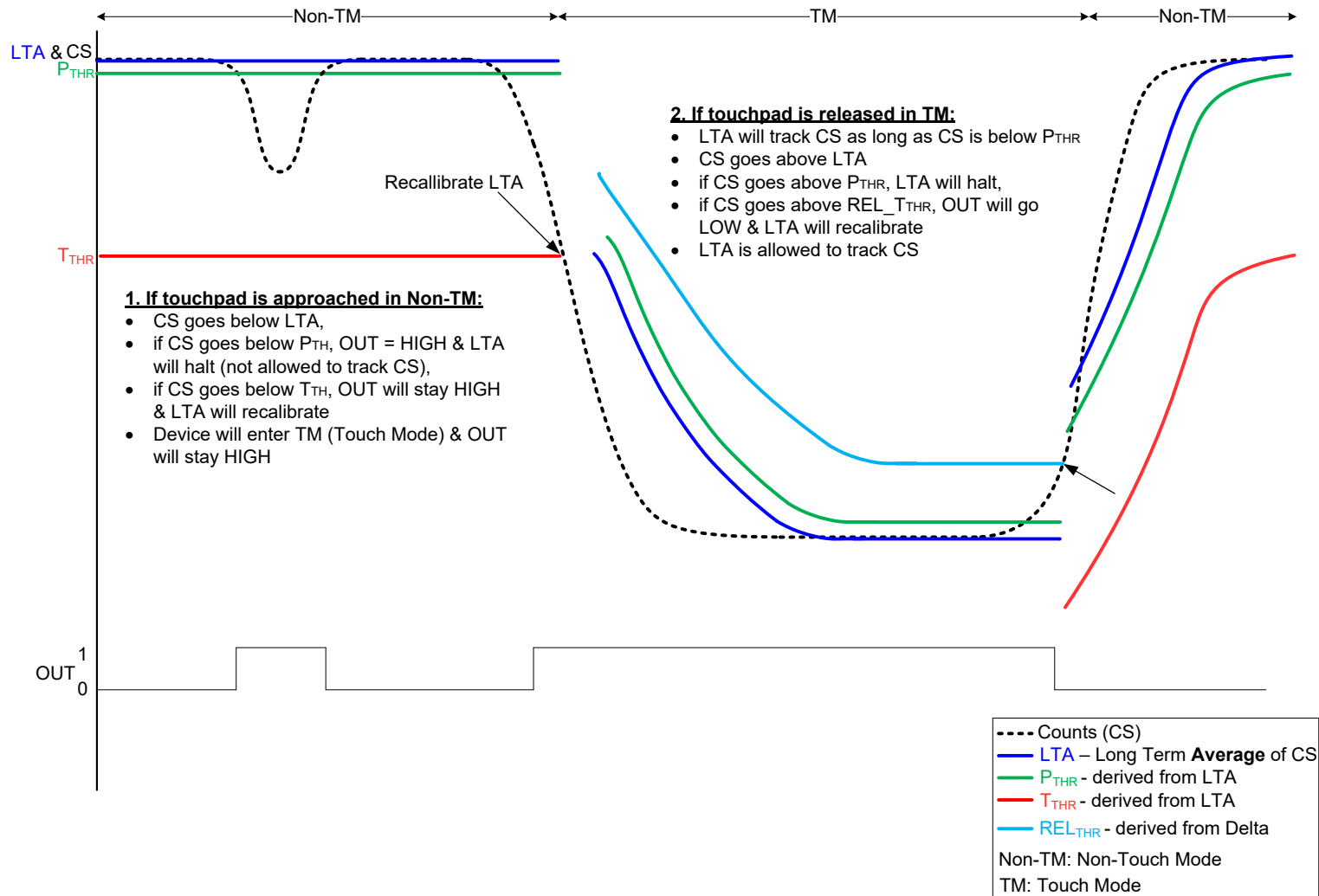

Figure 5.1 DYCAL Operation (Self Capacitive Sensing)

6 Operating Principle

Figure 5.1 is a visual representation of the DYCAL functionality. The OUT pin is used to indicate the status of a DYCAL event (both proximity and a touch event). The DYCAL functionality is summarised below.

Non-Touch Mode

The OUT pin is activated on the successful detection of a proximity event and will remain activated for the duration of the proximity event, permitting that this event is no longer than the filter halt timings. The LTA will be halted in this time.

As soon as a touch condition is detected (Count values, or CS, fall below T_{THR}), the controller will dynamically re-calibrate its LTA to the halted $LTA - T_{THR}$. The IC is now in Touch Mode.

Touch Mode

After the re-calibration of the LTA, it will follow the Counts (CS) and be allowed to track slow varying environmental changes. If the Counts (CS) were to exceed the LTA by the release threshold (REL_T_{THR}) the touch detection will stop and the OUT pin will return to its original state.

7 Configurable Settings

This section describes the user configurable options of the IQS228AS in more detail.

User programmable options are selected by configuring the OTP selections. Please refer

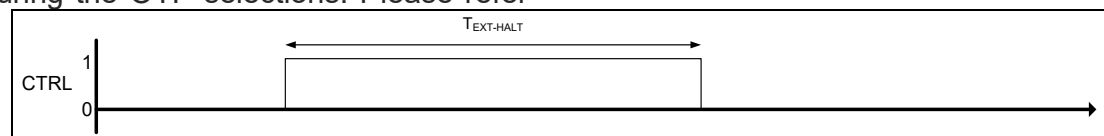

Figure 7.1 Master Output signal on CTRL pin to Halt Operation or Filter Halt

7.1.3 Pulse on CTRL:

The pulse on the CTRL pin needs to adhere to the following timing constraints:

$$25\text{ms} < T_{PULSE} < 35\text{ms}$$

7.1.3.1 IQS228AS: Reseed

A reseed condition can be initiated by generating a pulse on the CTRL pin. The

to Section 0 for an overview of the configurable settings.

7.1 CTRL: External Control

The user has the option to control some parameters of the IQS228AS from an external source. The IC can be used in default mode (CTRL unconnected) or the user can use the CTRL pin to select whether the master should halt the charge transfers (i.e. stop operation) or to halt LTA filter tracking on the IQS228AS.

7.1.1 Charge Halt

If CTRL is sampled high for longer than T_{EXT_HALT} , the charge conversion cycle will be halted, once the current conversion has been completed. The device will remain in this standby mode until the CTRL line is sampled low again. An automatic reseed is performed directly after CTRL is released to compensate for any environmental changes which might have occurred during the standby mode.

7.1.2 Halt LTA filter

When configured in this mode, CTRL can be used to control the LTA halt times when sampled high. The CTRL pin has precedence over the configurations bits selected for the halt timings.

If CTRL is sampled high for longer than T_{EXT_HALT} , the filter will be halted until this pin is sampled low.

LTA will be reset to the count, forcing the OUT pin to its original state.

If the count value is outside its allowable limits, the device will force an ATI event to reset the system sensitivity. (Please refer to section 8.1 for more detail).

7.1.3.2 IQS228AS: re-ATI

A re-ATI condition can be initiated by generating a pulse on the CTRL pin. This function can be issued at any time.

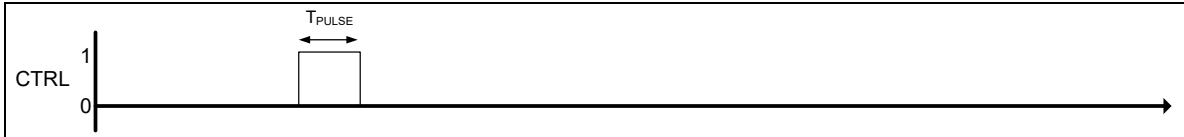

Figure 7.2 Master Output signal on CTRL to force a Reseed Condition

7.2 LOGIC

The logic used by the device can be selected as active HIGH or active LOW. The output pins OUT and CTRL will function based on this selection. When configured as Active High, the outputs will remain high after POR until ATI has completed. The ATI time will vary according to the capacitive load on the sensor, but typically does not exceed 500ms.

Configuration: [Bank0 bit5: Logic Output Selection](#)

Bit Selection

0	Software Open Drain Active Low
1	Active High

A software open drain output is implemented for the OUT pin when configured in active low mode. The voltage on the pull-up resistor is limited to the IQS228AS supply voltage. A 4k7-10kΩ resistor between OUT and VDDHI is recommended.

7.3 RF Noise on IQS228AS

7.3.1 ND: RF Noise Detection

The IQS228AS has RF Noise Detect (ND) functionality. If ND function is enabled, the IQS228AS is able to detect RF Noise on the TOUT/ND pin. Further details on the working of this can be found in the Application Notes: AZD015 and AZD015b.

7.3.2 IQS228AS RF Noise Immunity

The IQS228AS has advanced immunity to RF noise sources such as GSM cellular telephones, DECT, Bluetooth and WIFI devices. Design guidelines should however be followed to ensure the best noise immunity. The design of capacitive sensing applications can encompass a large range of situations but as a summary the following should be noted to improve a design:

- A ground plane should be placed under the IC, except under the Cx line.

- All the tracks on the PCB must be kept as short as possible.
- The capacitor between VDDHI and GND as well as between VREG and GND, must be placed as close as possible to the IC.
- A 100 pF capacitor should be placed in parallel with the 1uF capacitor between VDDHI and VSS. Another 100 pF capacitor can be placed in parallel with the 1uF capacitor between VREG and GND.
- If the device is too sensitive for a specific application a parasitic capacitor (max 20pF) can be added between the Cx line and ground.
- Proper sense electrode and button design principles must be followed.
- Unintentional coupling of sense electrode to ground and other circuitry must be limited by increasing the distance to these sources.
- In some instances a ground plane some distance from the device and sense electrode may provide significant shielding from undesired interference.

When the capacitance between the sense electrode and ground becomes too large the sensitivity of the device may be influenced.

7.4 Proximity Threshold

The IQS228AS has 4 proximity threshold settings indicated in counts. The proximity threshold is selected by the designer to obtain the desired sensitivity and noise immunity. A proximity event is triggered if the Counts (CS) diverges more than the selected threshold from the LTA for 6 consecutive cycles.

**Configuration: [Bank0 bit 1-0](#)****P_{THR1}:P_{THR0}:Proximity Thresholds****Bit Selection**

00	4
01	2 (Most sensitive)
10	8
11	16 (Least sensitive)

7.5 Touch Threshold

The IQS228AS has 8 touch threshold settings indicated in counts. The touch threshold is selected by the designer to obtain the desired touch sensitivity. A touch event is triggered if the Counts (CS) diverges more than the selected threshold from the LTA for 2 consecutive cycles.

In the NO-TOUCH state the Counts (CS) must diverge more than the touch threshold value below the LTA. Operating in the TOUCH STATE, the CS must diverge more than REL_T_{THR} of the touch threshold value above the LTA.

The following equation is used to determine if a touch or release event occurred.

NO TOUCH STATE: $LTA - CS \leq T_{THR}$

TOUCH STATE: $CS - LTA \geq REL_T_{THR}$

Configuration: [Bank0 bit 4-2](#) T_{THR2}:T_{THR0} Touch Thresholds**T_{THR2}:T_{THR0}: Touch Thresholds****Bit Selection**

000	72/256
001	4/256 (Most sensitive)
010	8/256
011	24/256
100	48/256
101	96/256
110	128/256
111	160/256 (Least sensitive)

7.6 Multipliers

When using partial ATI, the base value is set up using the multipliers. Compensation will still be added automatically to reach the target.

7.7 Charge Transfer

The charge transfer frequency of the IQS228AS is adjustable. Changing the

transfer frequency will affect sensitivity and response rate. Two options are available:

Configuration: [Bank2 bit6](#)**TRANS: Charge Transfer Frequency****Bit Selection**

0	512kHz
1	250kHz

7.8 Target Counts

The target of the ATI algorithm can be adjusted between 1200 (default) and 1024 counts. When less sensitivity is required, the lower counts will also increase response rate:

Configuration: [Bank2 bit3](#)**Target: ATI target counts****Bit Selection**

0	1200
1	1024

7.9 Enable Partial ATI

In some applications the startup time of the IQS228AS may be required to be decreased. This is possible by enabling partial ATI, if the multipliers required can be determined, and the compensation alone is adequate to account for environmental change.

Configuration: [Bank2 bit2](#)**ATI: Partial ATI****Bit Selection**

0	Disabled
1	Enabled

7.10 DYCAL TURBO

In some applications, it may be required to improve the entry and exit speed of Touch Mode by removing the entry reseed delay, as well as turning off the AC-filters. This can be done by enabling the DYCAL TURBO mode.

Configuration: [Bank1 bit3](#)**TURBO: DYCAL TURBO****Bit Selection**

0	Disabled
1	Enabled

Note that if Dycal Turbo is enabled, the LTA will halt at the reseed point for t_{HALT} if Touch Mode is entered before a proximity event is registered.



7.11 Filter Halt

The LTA filter only executes while no proximity events are detected to ensure compensation only for environmental changes. Once a touch event is detected the filter will resume operation and will no longer be halted. The halt timing configuration settings determine how long the filter is halted.

Configuration: [Bank1 bit 7-6](#)

Bit Selection

00 20 seconds
01 40 seconds
10 Never
11 3 seconds

The presence of a proximity condition for a time exceeding the halt time will be deemed as a fault state which would trigger a reseed event where after the output state on the OUT pin will be reset to its original condition.

7.12 Low Power Modes

There exist 4 LP modes. The LP modes will decrease the sampling frequency of CS which will reduce the [power consumption](#) of the device. However, this will also increase the response time of the device.

Configuration: [Bank2 bit 1-0](#)

Bit Selection

00 9.1ms (BP) 64ms if Zoom disabled
01 128ms (Normal Power Mode)
10 256ms (Low Power Mode 1)
11 512ms (Low Power Mode 2)

7.13 Zoom

The IQS228AS has the option to disable the zoom function. This means that the sample time will stay fixed, even when proximity and touch events are made. When this is activated, boost power mode will change from a 9ms sample time, to 64ms.

Configuration: [Bank3 bit3](#)

Zoom: Zoom Disable

Bit Selection

0 Enabled
1 Disabled

8 Streaming Mode

For a more complete description of the data streaming protocol, please refer to Application Note AZD017 on the Azoteq website.

The IQS228AS has the capability to stream data to a MCU. This provides the designer the ability to obtain the parameters and sensor data within the device in order to aid design into applications. Data streaming is performed as a 1-wire data protocol on the OUT pin OR I²C interface. The output function of this pin is therefore lost when the device is configured in streaming mode. Data Streaming can be enabled as indicated below:

Configuration: [Bank2 bit5: Streaming Mode](#)

Bit Selection

0 Disabled
1 Enabled

Figure 8.1 illustrates the communication protocol for initialising and sending data with the 1 wire communication protocol.

1. Communications initiated by a START bit. Bit defined as a low condition for T_{START} .
2. Following the START bit, is a synchronisation byte ($T_{INIT} = 0xAA$). This byte is used by the MCU for clock synchronisation.
3. Following T_{INIT} the data bytes will be sent. 8 Bytes will be sent after each charge cycle.
4. Each byte sent will be preceded by a START bit and a STOP bit will follow every byte.
5. STOP bit indicated by taking pin 1 high. The STOP bit does not have a defined period.

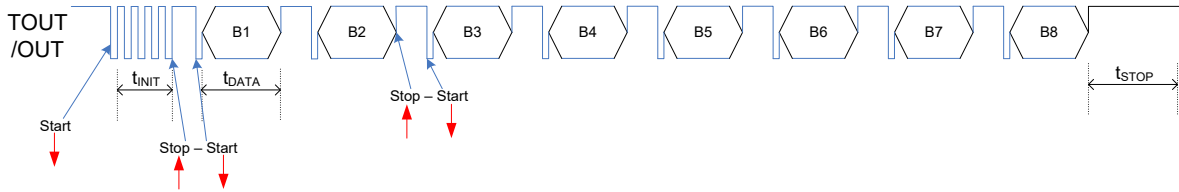

Figure 8.1 Debug: 1-wire streaming Debug Mode

The following table defines the bit definitions for the IQS228AS devices during Streaming Mode.

Table 8.1 Byte Definitions for Streaming Mode

Byte (B)	Bit	Value
0		AA
1	7:0	CS High byte
2	15:8	CS Low byte
3	23:16	LTA High byte
4	31:24	LTA Low byte
5 Sys Flags	39	~
	38	~
	37	Active High
	36	Filter Halt
	35	LP active
	34	ATI Busy
	33	Noise Found
32	In Zoom	
6	47	Touch
	46	Proximity
	45	Multipliers
	44	Multipliers
	43	Multipliers
	42	Multipliers
41	Multipliers	
40	Multipliers	
7	55:48	Compensation
8	63:56	Counter

8.1 Event Mode

The IQS228AS has Event Mode implemented during 1-wire communication. This allows the MCU to monitor the POUT pin for status changes (proximity or touch made or released events) instead of capturing data continuously. Upon a status change, the IQS228AS will pull the POUT pin for low to indicate to the MCU to read data. The POUT pin will stay low for 1.6ms.

8.2 I²C

The IQS228AS also allow for I²C streaming for debugging. Data Streaming can be changed from 1-wire protocol to I²C as shown below:

Configuration: Bank2 bit7: Streaming Mode

Bit Selection

- 0 1-Wire Protocol
- 1 I²C Streaming

The Memory Map for the IQS228AS can be found in Appendix A.

The IQS228AS can communicate on an I²C compatible bus structure. Note that 4.7kΩ pull-up resistors should be placed on SDA and SCL.

The Control byte indicates the 7-bit device address (0x44H) and the Read/Write indicator bit.

9 Auto Tuning Implementation (ATI)

ATI is a sophisticated technology implemented in the latest generation ProxSense® devices that optimises the performance of the sensor in a wide range of applications and environmental conditions (refer to application note AZD0027 - Auto Tuning Implementation).

ATI makes adjustments through external reference capacitors unnecessary (as required by most other solutions) to obtain optimum performance.

9.1 Full ATI

The IQS228AS implements an automatic ATI algorithm. This algorithm automatically adjusts the ATI parameters to optimise the sensing electrodes connection to the device.



The device will execute the ATI algorithm whenever the device starts-up and or when the counts are not within a predetermined range.

There are 2 important definitions to understand for ATI:

9.2 ATI Target

ATI adjusts internal circuitry according to two parameters, the **ATI multiplier** and the **ATI compensation**.

- The **ATI multiplier** can be viewed as a course adjustment of the Counts (CS), used to achieve the ATI BASE value.
- The **ATI compensation** is a fine adjustment used to reach the ATI TARGET value.

With these two parameters the Counts (CS) of the IQS228AS is tuned until an ATI target value of 1200 is achieved.

9.3 ATIBASE: Significance of ATI Base

As mentioned above, the **ATI multiplier** is used to select a base value for the ATI. The ATI BASE value is important, as this determines the sensitivity of the device. The sensitivity can be defined as:

$$\text{Sensitivity} = \text{ATI TARGET} / \text{ATI BASE}$$

The ATI Target remains fixed at 1200 and it can thus be seen from this that a larger base value will result in a less sensitive device. The designer has the option to increase/reduce the sensitivity of the system through the ATI BASE value. For most applications the ATI BASE should be kept default.

The options for the ATI BASE values are as follows:

Configuration: Bank1 bit 2-0

Bit Selection

000	200
001	50
010	75
011	100
100	150
101	250
110	300
111	500

9.4 Sensitivity due to ATI

The adjustment of the ATI parameters will result in variations in the count and sensitivity. Sensitivity can be observed as the change in count as the result of a fixed change in sensed capacitance. The ATI parameters have been chosen to provide significant overlap. It may therefore be possible to select various combinations of ATI multiplier and ATI compensation settings to obtain the same count. The sensitivity of the various options may however be different for the same count.

9.5 ATI Procedure

While the Automatic ATI algorithm is in progress this condition will be indicated in the streaming data and proximity and touch events cannot be detected. The device will only briefly remain in this condition and it will be entered only when relatively large shifts in the count has been detected.

The automatic ATI function aims to maintain a constant count, regardless of the capacitance of the sense electrode (within the maximum range of the device).

The effects of auto-ATI on the application are the following:

- Automatic adjustment of the device configuration and processing parameters for a wide range of PCB and application designs to maintain an optimal configuration for proximity and touch detection.
- Automatic tuning of the sense electrode at start-up to optimise the sensitivity of the application.
- Automatic re-tuning when the device detects changes in the sensing electrodes capacitance to



accommodate a large range of changes in the environment of the application that influences the sensing electrode.

- Re-tuning only occurs during device operation when a relatively large sensitivity reduction is detected. This is to ensure smooth operation of the device during operation.
- Re-tuning may temporarily influences the normal functioning of the device, but in most instances the effect will be hardly noticeable.
- Shortly after the completion of the re-tuning process the sensitivity of a Proximity detection may be reduced slightly for a few seconds as internal filters stabilises.

Automatic ATI can be implemented so effectively due to:

- Excellent system signal to noise ratio (SNR).
- Effective digital signal processing to remove AC and other noise.
- The very stable core of the devices.
- The built-in capability to accommodate a large range of sensing electrode capacitances.

10 DYCAL Specific settings

10.1 Release Threshold

The IQS228AS has the option to increase the release threshold when in TM. This helps that small variations caused by moving a finger/hand on a touch pad will not cause the IC to exit TM, making the solution more robust. The options available are shown below:

Configuration: [Bank0 bit6](#)

Bit Selection	
0	75% of Entry Delta
1	87.5% of Entry Delta

After entering TM, as soon as the LTA follows to within 16 counts, a Entry Delta value is calculated as:

- $Entry\ Delta = LTA_{entry} - LTA_{current}$

This calculated Entry Delta value is used for the Release Threshold as shown above.

If upon entry, the LTA value is already within 16 Counts, the Entry Delta is taken as the calculated touch threshold value.

10.2 Input Enable

The IQS228AS can be configured to have the CTRL pin function as an output on a Proximity event.

Choosing the CTRL pin as output removes the Filter Halt and Halt Charge options of the pin as an input.

Using a touch event to activate OUT will make the system less sensitive which is needed in some applications. The LTA will still halt with the detection of a proximity but will not have an influence on the OUT pin. The LTA will still re-calibrate once a touch condition is detected.

Configuration: [Bank0 bit7](#)

Bit Selection	
0	Output
1	Input



11 Electrical Specifications

11.1 Absolute Maximum Specifications

Exceeding these maximum specifications may cause damage to the device.

Operating temperature	-20°C to 85°C
Supply Voltage ($V_{DDHI} - V_{SS}$)	3.6V
Maximum pin voltage (OUT, CTRL)	$V_{DDHI} + 0.3V$
Pin voltage (Cx)	1.7V
Minimum pin voltage (VDDHI, VREG, OUT, CTRL, Cx)	$V_{SS} - 0.3V$
Minimum power-on slope	100V/s
ESD protection (VDDHI, VREG, V_{SS} , OUT, CTRL, Cx)	8kV

11.2 General Characteristics

IQS228AS devices are rated for supply voltages between 1.8V and 3.6V.

Table 11.1 IQS228AS General Operating Conditions

DESCRIPTION	Conditions	PARAMETER	MIN	TYP	MAX	UNIT
Supply voltage		V_{DDHI}	1.8		3.6	V
Internal regulator output	$1.8 \leq V_{DDHI} \leq 3.6$	V_{REG}	1.64	1.7	1.76	V
Boost Power operating current	$1.8 \leq V_{DDHI} \leq 3.6$	$I_{IQS228AS_BP}$	120	129	135	μA
Normal Power operating current	$1.8 \leq V_{DDHI} \leq 3.6$	$I_{IQS228AS_NP}$	4.9	6.45	8.1	μA
Low power 1 operating current	$1.8 \leq V_{DDHI} \leq 3.6$	$I_{IQS228AS_LP1}$	2.95	3.8	4.85	μA
Low power 2 operating current	$1.8 \leq V_{DDHI} \leq 3.6$	$I_{IQS228AS_LP2}$	1.88	$<2.5^1$	3.2	μA

Charge Transfer Timings for low power mode is found in [Section 7.12](#).

Table 11.2 Start-up and shut-down slope Characteristics

DESCRIPTION	Conditions	PARAMETER	MIN	MAX	UNIT
POR	V_{DDHI} Slope $\geq 100V/s$	POR		1.55	V
BOD		BOD	1		V

¹ All low power current values arise from characterization done from (-)35°C to (+)85°C at 3.3V.



11.3 Output Characteristics¹

Table 11.3 TOUT Characteristics

Symbol	Description	V _{OH}	Conditions	MIN	TYP	MAX	UNIT
I _{SOURCE}	Output High voltage	0.9*VDDHI	V _{DDHI} = 3.6V	~	~	TBD	mA
		0.9*VDDHI	V _{DDHI} = 3.3V	~	10	~	
		0.9*VDDHI	V _{DDHI} = 1.8V	TBD	~	~	
Symbol	Description	V _{OL}	Conditions	MIN	TYP	MAX	UNIT
I _{SINK}	Output Low voltage	100mV	V _{DDHI} = 3.6V			TBD	mA
		100mV	V _{DDHI} = 3.3V		10		
		100mV	V _{DDHI} = 1.8V	TBD			

Table 11.4 POUT Characteristics

Symbol	Description	V _{OH}	Conditions	MIN	TYP	MAX	UNIT
I _{SOURCE}	Output High voltage	0.9*VDDHI	V _{DDHI} = 3.6V	~	~	TBD	mA
		0.9*VDDHI	V _{DDHI} = 3.3V	~	10	~	
		0.9*VDDHI	V _{DDHI} = 1.8V	TBD	~	~	
Symbol	Description	V _{OL}	Conditions	MIN	TYP	MAX	UNIT
I _{SINK}	Output Low voltage	0.1V	V _{DDHI} = 3.6V			TBD	mA
		0.1V	V _{DDHI} = 3.3V		10		
		0.1V	V _{DDHI} = 1.8V	TBD			

Table 11.5 Combined Characteristics

Symbol	Description	V _{OH}	Conditions	MIN	TYP	MAX	UNIT
I _{SOURCE}	Output High voltage	0.9*VDDHI	V _{DDHI} = 3.6V	~	~	TBD	mA
		0.9*VDDHI	V _{DDHI} = 3.3V	~	17	~	
		0.9*VDDHI	V _{DDHI} = 1.8V	TBD	~	~	
Symbol	Description	V _{OL}	Conditions	MIN	TYP	MAX	UNIT
I _{SINK}	Output Low voltage	0.1V	V _{DDHI} = 3.6V			TBD	mA
		0.V	V _{DDHI} = 3.3V		20		
		0.1V	V _{DDHI} = 1.8V	TBD			

¹ I/O sink capabilities only in Active Low configuration. I/O source capabilities only in Active High configuration.

11.4 Packaging Information

11.4.1 TSOT23-6

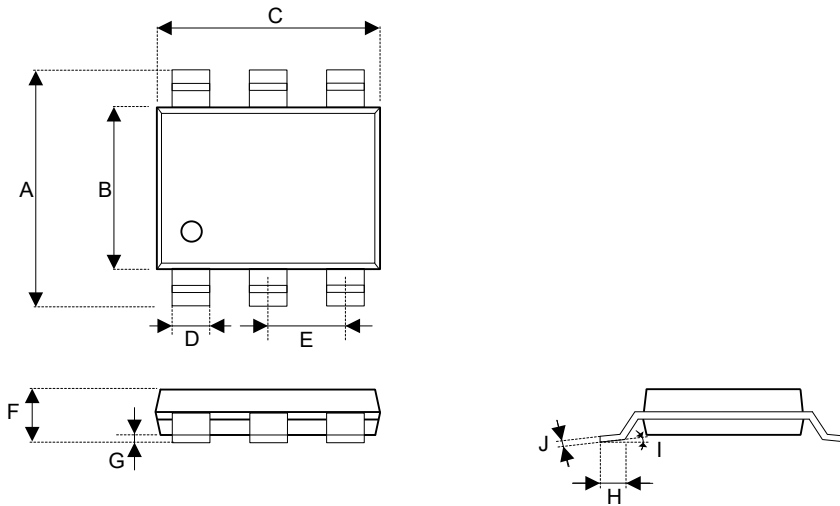

Figure 11.1 TSOT23-6 Packaging¹

Table 11.6 TSOT23-6 Dimensions

Dimension	Min (mm)	Max (mm)
A	2.60	3.00
B	1.50	1.70
C	2.80	3.00
D	0.30	0.50
E	0.95 Basic	
F	0.84	1.00
G	0.00	0.10
H	0.30	0.50
I	0°	8°
J	0.03	0.20

¹ Drawing not on Scale



11.4.2 MSL Level

Moisture Sensitivity Level (MSL) relates to the packaging and handling precautions for some semiconductors. The MSL is an electronic standard for the time period in which a moisture sensitive device can be exposed to ambient room conditions (approximately 30°C/85%RH see J-STD033C for more info) before reflow occur.

Package	Level (duration)
TSOT23-6	MSL 1 (Unlimited at ≤ 30 °C/85% RH) Reflow profile peak temperature < 260 °C for < 30 seconds



12 Datasheet and Part-number Information

12.1 Ordering Information

Orders will be subject to a MOQ (Minimum Order Quantity) of a full reel. Contact the official distributor for sample quantities. A list of the distributors can be found under the “Distributors” section of www.azoteq.com.

For large orders, Azoteq can provide pre-configured devices.

The Part-number can be generated by using USBProg.exe or the Interactive Part Number generator on the website.

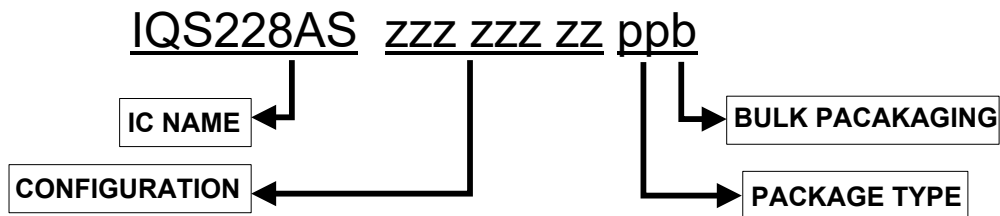

IC NAME	IQS228AS = IQS228 Self Capacitive
CONFIGURATION	zzz zzz zz = IC Configuration (hexadecimal)
PACKAGE TYPE	TS = TSOT23-6
BULK PACKAGING	R = Reel (3000pcs/reel) MOQ = 1 reel. Mass production orders shipped as full reels.

12.2 Device Marking – Top

There are 2 marking versions in circulation for IQS228AS:

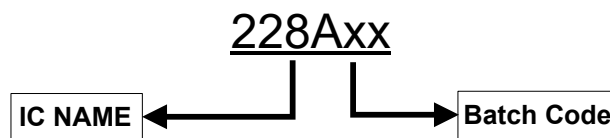

Figure 12.1 First Marking Variant.

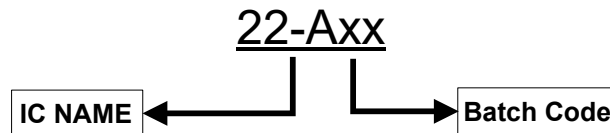
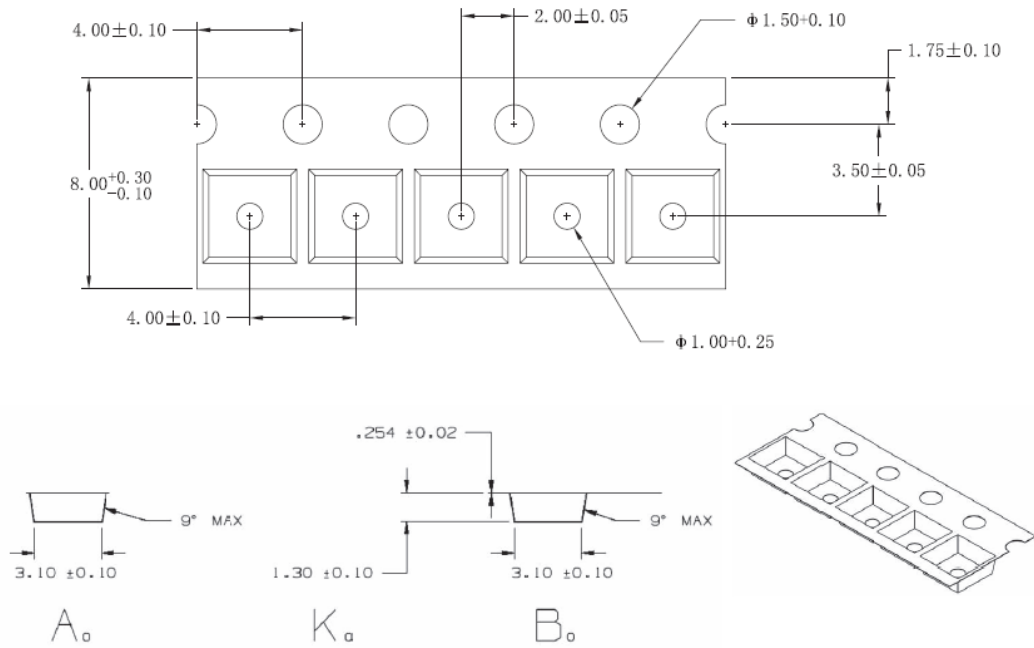

Figure 12.2 Second Marking Variant.

IC NAME	228A = IQS228AS Self Capacitive 22-A = IQS228AS Self Capacitive
Batch Code	xx = AA to ZZ



NOTE:
1. Material is PC;
2. Material : 3000.

Figure 12.3 TSOT23-6 Tape Specification.



13 Revision History

Revision	Device ID ⁴	Package Markings	Description
0		228S	Released to alpha customers
1	39 29	228AAB	IQS228AS Self Capacitive Sensor Mass Production

⁴ Refers to product number and firmware version



Appendix A. Memory Map

Device Information

00H		Product Number (PROD_NR)								
		Bit	7	6	5	4	3	2	1	0
Access	R	Value	39 (Decimal)							
		Note								

01H		Software Number (SW_NR)								
		Bit	7	6	5	4	3	2	1	0
Access	R	Value	29 (Decimal)							
		Note								

[00H] PROD_NR

The product number for the IQS228A is 39 (decimal).

[01H] SW_NR

The software version number of the device ROM can be read in this byte. The latest software version is 29 (decimal).

10H		System Flags (Sys_Flags)								
		Bit	7	6	5	4	3	2	1	0
Access	R	Value		~	Logic	Halt	LP	ATI	ND	Zoom
		Note								

[10H] SYSFLAGS0

Bit 7-6: **SYSTEM_USE**

Bit 5: **Logic:** Logic Output Indication

0 = Active Low

1 = Active High

Bit 4: **Halt:** Indicates Filter Halt status

0 = LTA not being Halted

1 = LTA Halted

Bit 3: **LP:** Low Power Mode

0 = Sample time BP

1 = Sample time LP

Bit 2: **ATI:** Status of automated ATI routine

0 = ATI is not busy

1 = ATI in progress

Bit 1: **ND:** This bit indicates the presence of noise interference.

0 = IC has not detected the presence of noise



1 = IC has detected the presence of noise

Bit 0:

ZOOM: Zoom will indicate full-speed charging once an undebounced proximity is detected. In BP mode, this will not change the charging frequency.

0 = IC not zoomed in

1 = IC detected undebounced proximity and IC is charging at full-speed (BP)

31H

		Status							
		7	6	5	4	3	2	1	0
Access		DYCAL						Touch	Proximity
	R	Note							

[31H] Status

Bit 7:

Dycal: Dycal Detection

0 = Not Active

1 = Active

Bit 6:2:

SYSTEM_USE

Bit 1:

Touch: Touch Detection

0 = Not Active

1 = Active

Bit 0:

Prox: Proximity Detection

0 = Not Active

1 = Active

42H

		Counts_High (CS_H)							
		7	6	5	4	3	2	1	0
Access		Counts High Byte							
	R	Note							

43H

		Counts_Low (CS_L)							
		7	6	5	4	3	2	1	0
Access		Counts Low Byte							
	R	Note							

83H

		LTA_High (LTA_H)							
		7	6	5	4	3	2	1	0
Access		Long Term Average High Byte							
	R	Note							



84H	LTA_Low (LTA_L)								
	Bit	7	6	5	4	3	2	1	0
	Access	Value							
	R	Long Term Average Low Byte							
	Note								

C4H	Fuse Bank 0 (FB_0)								
	Bit	7	6	5	4	3	2	1	0
	Access	Value							
	R	See Table 3.1 for more details							
	Note								

C5H	Fuse Bank 1 (FB_1)								
	Bit	7	6	5	4	3	2	1	0
	Access	Value							
	R	See Table 3.2 for more details							
	Note								

C6H	Fuse Bank 2 (FB_2)								
	Bit	7	6	5	4	3	2	1	0
	Access	Value							
	R	See Table 3.4 for more details							
	Note								

C7H	Fuse Bank 3 (FB_3)								
	Bit	7	6	5	4	3	2	1	0
	Access	Value							
	R	See Table 3.5 for more details							
	Note								

C8H	DEFAULT_COMMS_POINTER								
	Bit	7	6	5	4	3	2	1	0
	Access	Value							
	R/W	(Beginning of Device Specific Data)							
	Default	10H							

[C8H] Default Comms Pointer

The value stored in this register will be loaded into the Comms Pointer at the start of a communication window. For example, if the design only requires the Proximity Status information each cycle, then the *Default Comms Pointer* can be set to ADDRESS '31H'. This would mean that at the start of each communication window, the comms pointer would already be set to the Proximity Status register, simply allowing a READ to retrieve the data, without the need of setting up the address.



Appendix B. Errata

Filter halt times

When the “[Zoom Disable](#)” bit is set, the halt times as specified in Section 3 will be scaled 16 x longer, due to added dead time when the IC core is turned off to reduce power consumption:

User Selectable Configuration Options: Bank 1 – Full ATI ([0xC5H](#))

t_{HALT1}	t_{HALT0}	~	~	TURBO	BASE ₂	BASE ₁	BASE ₀
bit 7							bit 0

Bank1: bit 7-6 t_{HALT} : Halt times [Section 7.11](#)
 00 = 320 seconds
 01 = 640 seconds
 10 = Never
 11 = 48 seconds



Appendix C. Contact Information

	USA	Asia	South Africa
Physical Address	6507 Jester Blvd Bldg 5, suite 510G Austin TX 78750 USA	Rm2125, Glittery City Shennan Rd Futian District Shenzhen, 518033 China	109 Main Street Paarl 7646 South Africa
Postal Address	6507 Jester Blvd Bldg 5, suite 510G Austin TX 78750 USA	Rm2125, Glittery City Shennan Rd Futian District Shenzhen, 518033 China	PO Box 3534 Paarl 7620 South Africa
Tel	+1 512 538 1995	+86 755 8303 5294 ext 808	+27 21 863 0033
Fax	+1 512 672 8442		+27 21 863 1512
Email	info@azoteq.com	info@azoteq.com	info@azoteq.com

Please visit www.azoteq.com for a list of distributors and worldwide representation.

The following patents relate to the device or usage of the device: US 6,249,089; US 6,952,084; US 6,984,900; US 7,084,526; US 7,084,531; US 8,395,395; US 8,531,120; US 8,659,306; US 8,823,273; US 9,209,803; US 9,360,510; EP 2,351,220; EP 2,559,164; EP 2,656,189; HK 1,156,120; HK 1,157,080; SA 2001/2151; SA 2006/05363; SA 2014/01541; SA 2015/023634

IQ Switch®, SwipeSwitch™, ProxSense®, LightSense™, AirButton™, ProxFusion™, Crystal Driver™ and the  logo are trademarks of Azoteq.

The information in this Datasheet is believed to be accurate at the time of publication. Azoteq uses reasonable effort to maintain the information up-to-date and accurate, but does not warrant the accuracy, completeness or reliability of the information contained herein. All content and information are provided on an "as is" basis only, without any representations or warranties, express or implied, of any kind, including representations about the suitability of these products or information for any purpose. Values in the datasheet is subject to change without notice, please ensure to always use the latest version of this document. Application specific operating conditions should be taken into account during design and verified before mass production. Azoteq disclaims all warranties and conditions with regard to these products and information, including but not limited to all implied warranties and conditions of merchantability, fitness for a particular purpose, title and non-infringement of any third party intellectual property rights. Azoteq assumes no liability for any damages or injury arising from any use of the information or the product or caused by, without limitation, failure of performance, error, omission, interruption, defect, delay in operation or transmission, even if Azoteq has been advised of the possibility of such damages. The applications mentioned herein are used solely for the purpose of illustration and Azoteq makes no warranty or representation that such applications will be suitable without further modification, nor recommends the use of its products for application that may present a risk to human life due to malfunction or otherwise. Azoteq products are not authorized for use as critical components in life support devices or systems. No licenses to patents are granted, implicitly, express or implied, by estoppel or otherwise, under any intellectual property rights. In the event that any of the abovementioned limitations or exclusions does not apply, it is agreed that Azoteq's total liability for all losses, damages and causes of action (in contract, tort (including without limitation, negligence) or otherwise) will not exceed the amount already paid by the customer for the products. Azoteq reserves the right to alter its products, to make corrections, deletions, modifications, enhancements, improvements and other changes to the content and information, its products, programs and services at any time or to move or discontinue any contents, products, programs or services without prior notification. For the most up-to-date information and binding Terms and Conditions please refer to www.azoteq.com

www.azoteq.com/ip

info@azoteq.com



Компания «ЭлектроПласт» предлагает заключение долгосрочных отношений при поставках импортных электронных компонентов на взаимовыгодных условиях!

Наши преимущества:

- Оперативные поставки широкого спектра электронных компонентов отечественного и импортного производства напрямую от производителей и с крупнейших мировых складов;
- Поставка более 17-ти миллионов наименований электронных компонентов;
- Поставка сложных, дефицитных, либо снятых с производства позиций;
- Оперативные сроки поставки под заказ (от 5 рабочих дней);
- Экспресс доставка в любую точку России;
- Техническая поддержка проекта, помощь в подборе аналогов, поставка прототипов;
- Система менеджмента качества сертифицирована по Международному стандарту ISO 9001;
- Лицензия ФСБ на осуществление работ с использованием сведений, составляющих государственную тайну;
- Поставка специализированных компонентов (Xilinx, Altera, Analog Devices, Intersil, Interpoint, Microsemi, Aeroflex, Peregrine, Syfer, Eurofarad, Texas Instrument, Miteq, Cobham, E2V, MA-COM, Hittite, Mini-Circuits, General Dynamics и др.);

Помимо этого, одним из направлений компании «ЭлектроПласт» является направление «Источники питания». Мы предлагаем Вам помощь Конструкторского отдела:

- Подбор оптимального решения, техническое обоснование при выборе компонента;
- Подбор аналогов;
- Консультации по применению компонента;
- Поставка образцов и прототипов;
- Техническая поддержка проекта;
- Защита от снятия компонента с производства.



Как с нами связаться

Телефон: 8 (812) 309 58 32 (многоканальный)

Факс: 8 (812) 320-02-42

Электронная почта: org@eplast1.ru

Адрес: 198099, г. Санкт-Петербург, ул. Калинина, дом 2, корпус 4, литера А.