



Product Description

GRF2374 is a low noise amplifier (LNA) with bypass designed for high-performance WLAN/ISM and other applications up to 3.8 GHz. Ideal for low power, cost sensitive bypass amplifier applications.

The LNA is operated from a single positive supply of 2.7 to 5.0 V with typical bias condition of 3.3 volts and 15 mA.

Consult with the GRF applications engineering team for custom tuning/evaluation board data and device s-parameters.

Features

Reference: 3.3V/15mA/2.4 GHz

- EVB NF: 1.4 dB
- Gain: 14.0 dB
- Bypass Gain: -2.0 dB
- OP1dB: 10.0 dBm

- Flexible voltage: 2.7 to 5.0 volts
- Simple matching to 50 ohms
- Process: InGaP HBT

Applications

- WiFi Access Points
- Mobile WiFi Devices
- Cellular Boosters
- Drones
- Set Top Boxes
- VHF/UHF/900/2400 ISM

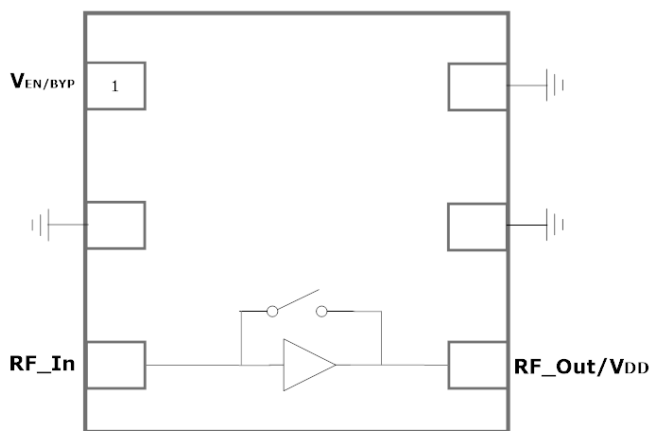

1.5 x 1.5 mm DFN-6

Absolute Ratings:

Parameter	Symbol	Min.	Max.	Unit
Supply Voltage	V _{DD}	0	5.5	V
RF Input Power: (Load VSWR < 2:1; V _c : 5.0 volts)	P _{IN MAX}		20	dBm
Operating Temperature (Package Heat Sink)	T _{AMB}	-40	85	°C
Maximum Channel Temperature (MTTF > 10 ⁶ Hours)	T _{MAX}		150	°C
Maximum Dissipated Power	P _{DISS MAX}		100	mW
Electrostatic Discharge:				
Charged Device Model: (TBD)	CDM	1500		V
Human Body Model: (TBD)	HBM	250		V
Storage:				
Storage Temperature	T _{STG}	-65	150	°C
Moisture Sensitivity Level	MSL		1	--



Caution! ESD Sensitive Device



Exceeding Absolute Maximum Rating conditions may cause permanent damage to the device.

Note: For package dimensions and manufacturing information, see the Guerrilla-RF.com website for the following document located on the GRF2374 landing page (coming soon): Manufacturing Note—MN-001 Product Tape and Reel, Solderability and Package Outline Specification.

[Link to manufacturing note](#)

Pin Out (Top View)

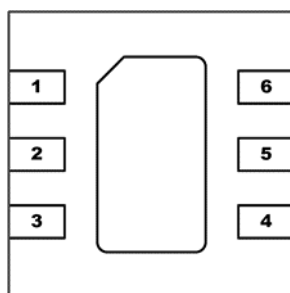

Pin Assignments:

Pin	Name	Description	Note
1	V_{ENABLE}/BYPASS	LNA enable/Bypass Control	V _{ENABLE} and series resistor set I _{DDQ} . V _{ENABLE} < 0.2 volts disables device. On-die pull-down resistor will turn the part off if this node is allowed to float.
2	NC	No Connect or Ground	No internal connections to die
3	RF_In	LNA RF input	Requires external DC block.
4	RF_Out/V_{CC}	LNA RF output	Requires external bias inductor followed by DC block.
5	NC	No Connect or Ground	No internal connections to die
6	NC	No Connect or Ground	No internal connections to die
PKG BASE	GND	Ground	Provides DC and RF ground for LNA, as well as thermal heat sink. Recommend multiple 8 mil vias beneath the package for optimal RF and thermal performance. Refer to evaluation board top layer graphic on schematic page.

V_{ENABLE} Truth Table:

Mode	Description	V _{ENABLE} /BYPASS
High Gain	High LNA Gain	1
Bypass	High Linearity Bypass	0
Logic Level "0"	Logic Low	0.0V to 0.3V
Logic Level "1"	Logic High	1.5V to V _{CC}



Preliminary

GRF2374

Low Current LNA w/Bypass
Tuning Range: 0.1 to 3.8 GHz

Nominal Operating Parameters:

Parameter	Symbol	Specification			Unit	Condition
		Min.	Typ.	Max.		
High Gain Mode						$V_{CC} = 3.3\text{ V}; V_{ENABLE}: \text{High}$
Test Frequency	F_{TEST}		2.4		GHz	
Gain	S21		14.0		dB	
Noise Figure (Evaluation Board)	NF		1.4		dB	
Input Power for 1.0% EVM (Gain Mode)	IP1%		TBD		dBm	Waveform: 802.11g;/n PAR: 11.6 dB
Input Power for 1.0% EVM (Bypass Mode)	IP1%		TBD		dBm	Waveform: 802.11g;/n PAR: 11.6 dB
Output 1dB Compression Point	OP1dB		10.0		dBm	
Output Intercept Point	OIP3		19.5		dBm	-5.0 dBm P_{OUT} per tone (2399 and
Supply Current	I_{CC}		15		mA	
Enable Current	I_{ENABLE}		1.7		mA	
Bypass Mode						$V_{CC}: 3.3\text{ V}; V_{EN}: 0.0\text{ V}$
Gain	S(2,1)		-2.0		dB	
Supply Current	I_{CC}		4.0		mA	
Thermal Data						
Thermal Resistance (Infra-Red Scan)	Θ_{JC}		700		$^{\circ}\text{C}/\text{W}$	
Channel Temperature @ +85 C reference (Package heat sink)	$T_{CHANNEL}$		120		$^{\circ}\text{C}$	$V_{CC}: 3.3\text{ V}; I_{CC}: 15\text{ mA}; \text{No RF}; \text{Dissipated Power}: 50\text{ mW}$



Preliminary

GRF2374

Low Current LNA w/Bypass
Tuning Range: 0.1 to 3.8 GHz

GRF2374 Evaluation Board Measured Data (Gain and Bypass Modes)

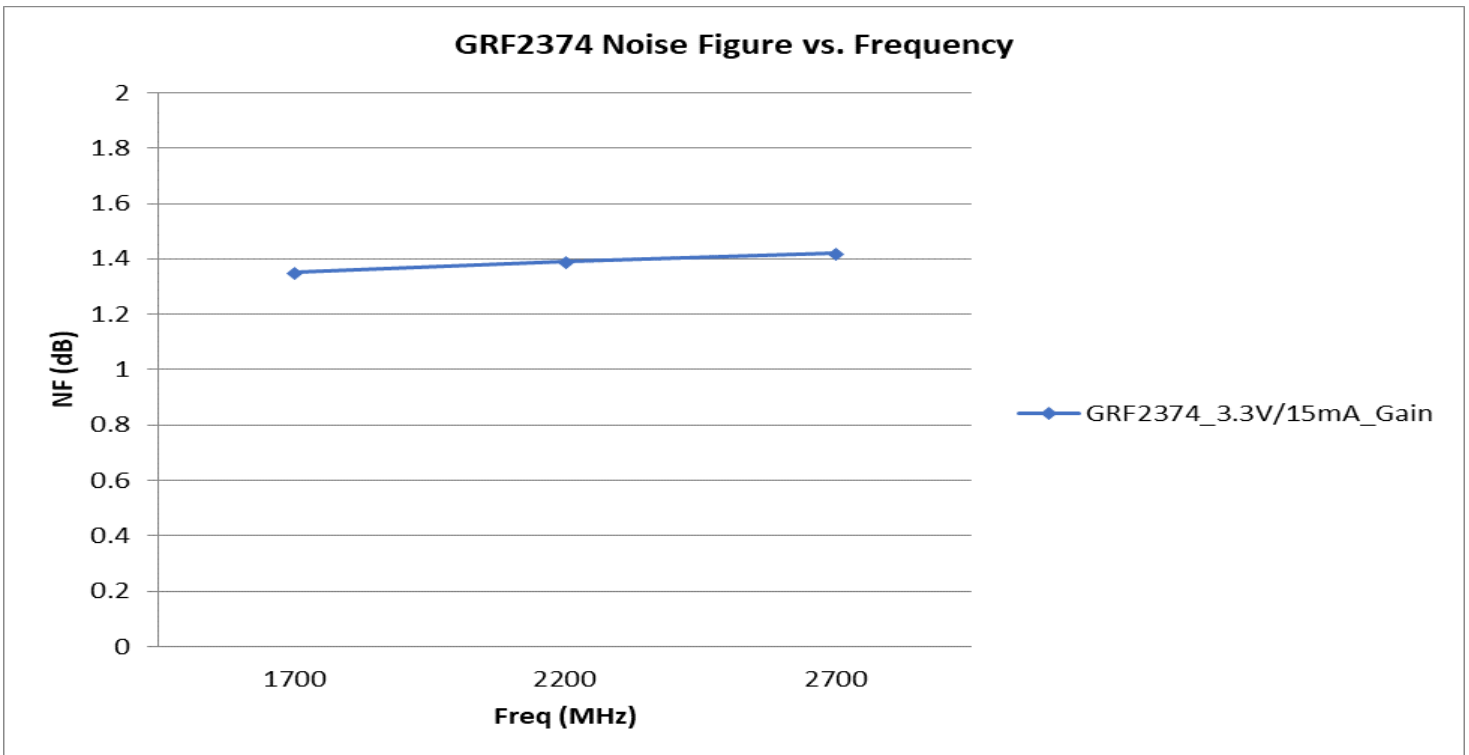
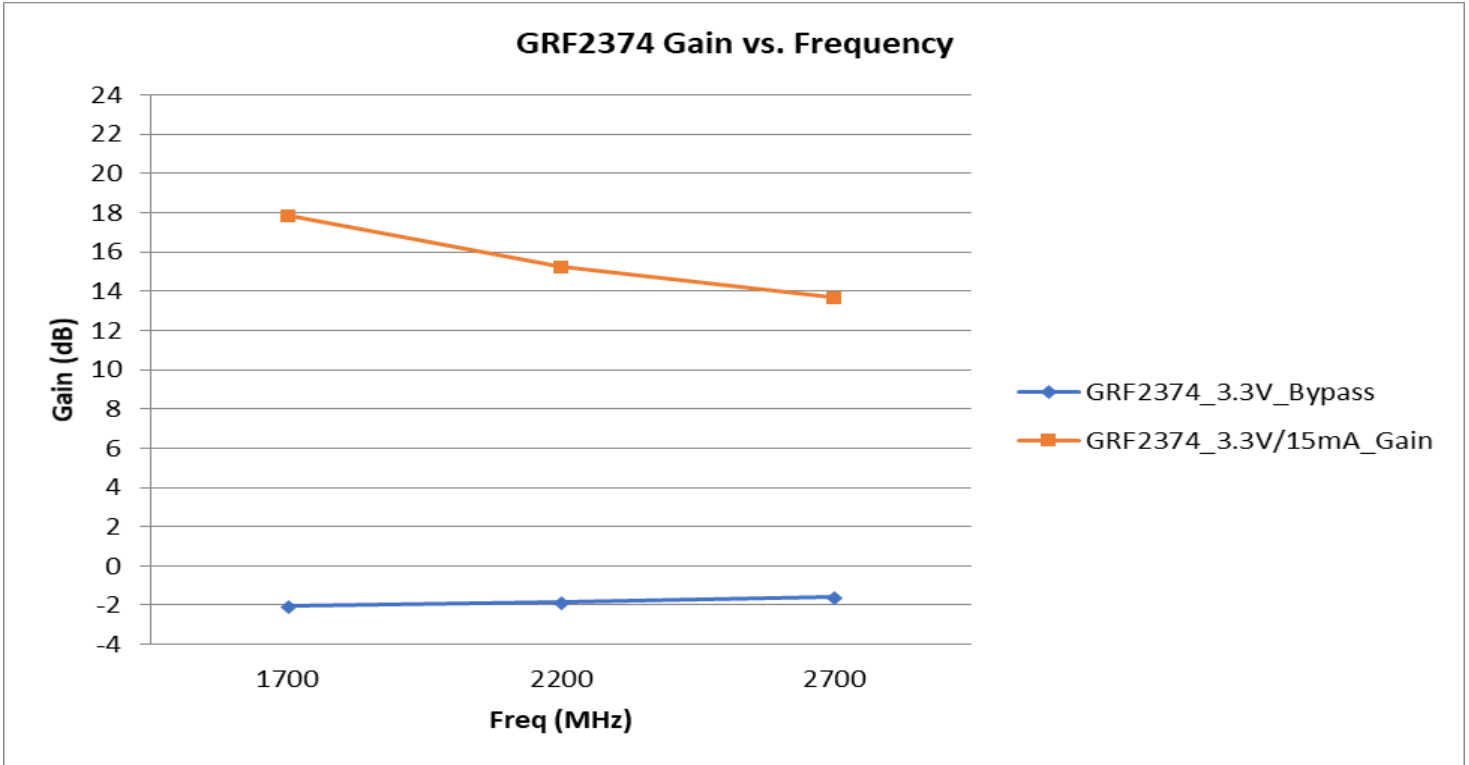



Preliminary

GRF2374

Low Current LNA w/Bypass
Tuning Range: 0.1 to 3.8 GHz

GRF2374 Evaluation Board Measured Data (Gain and Bypass Modes)

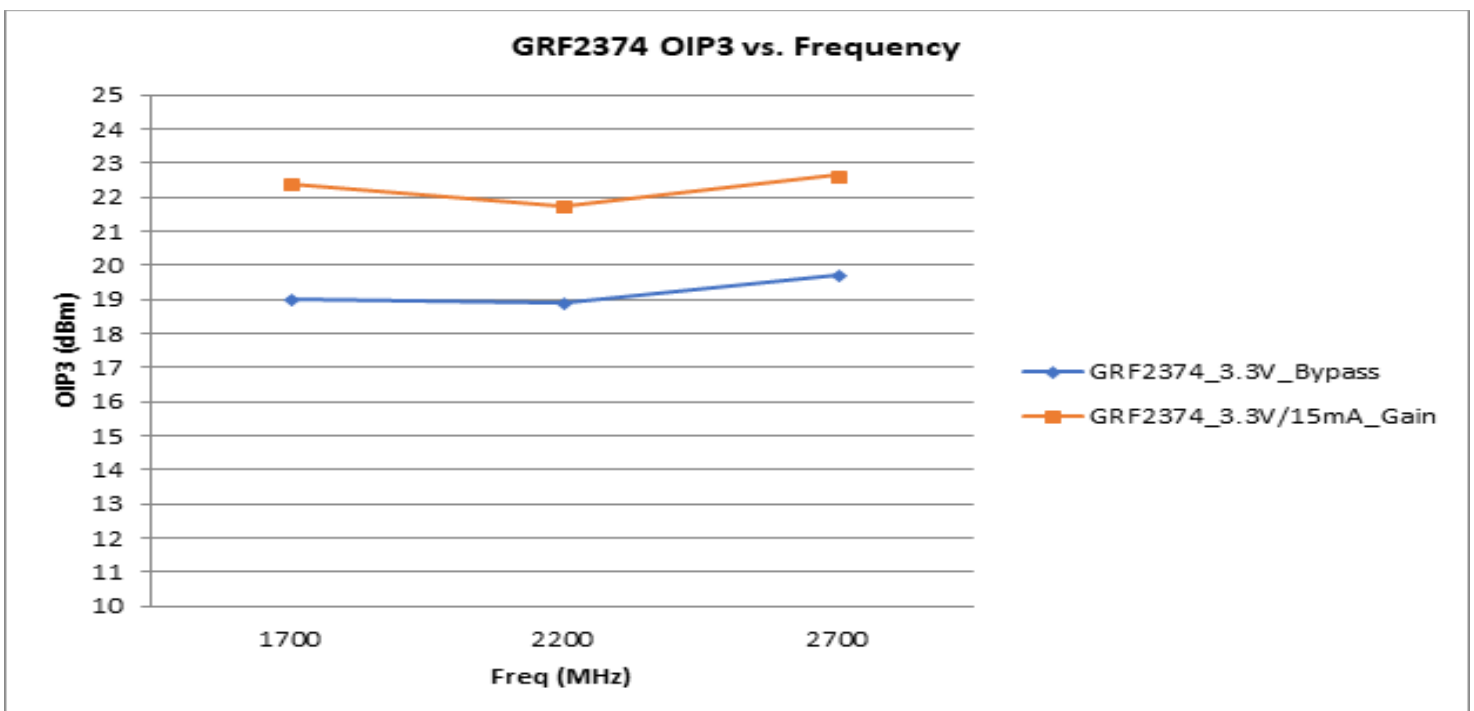
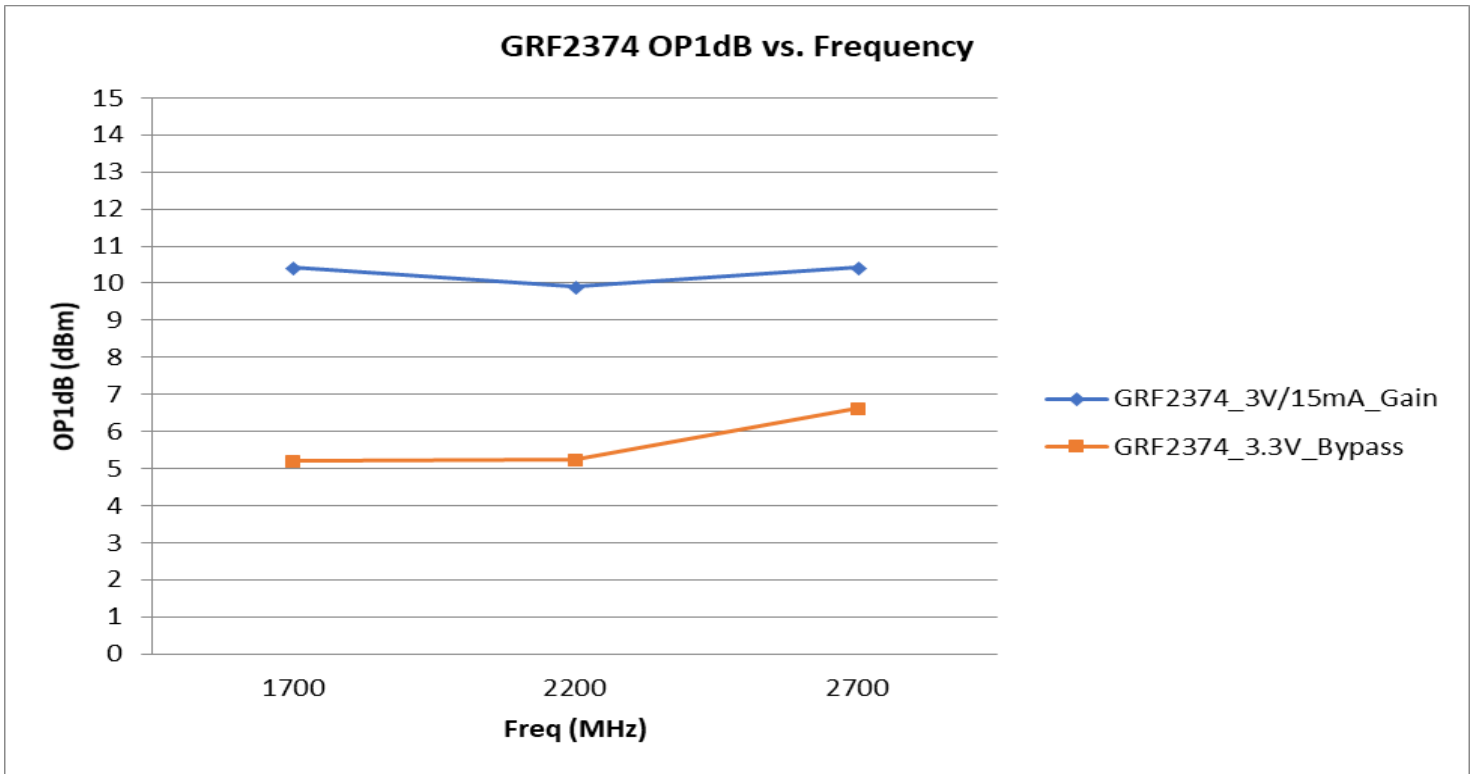



Preliminary

GRF2374

Low Current LNA w/Bypass
Tuning Range: 0.1 to 3.8 GHz

GRF2370 Evaluation Board S-Pars and Stability Mu Factor (Gain/Bypass Modes)

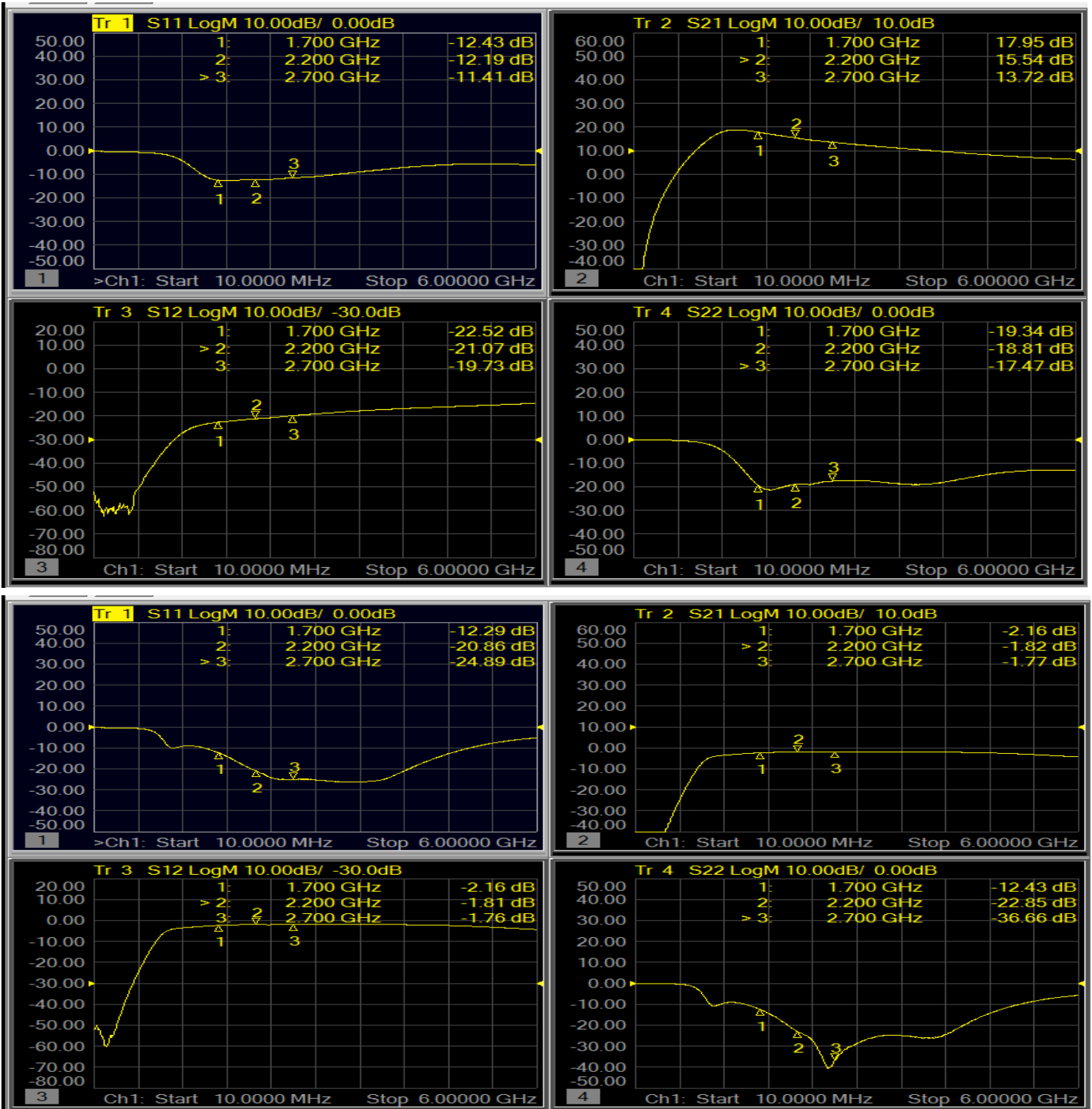

Note: $\mu \geq 1.0$ implies unconditional stability

Guerrilla RF Proprietary Information. Guerrilla RF™ and the composite logo of Guerrilla RF™ are trademarks of Guerrilla RF, Inc. ©2014 Guerrilla RF, Inc. All rights reserved.



Preliminary

GRF2374

Low Current LNA w/Bypass
Tuning Range: 0.1 to 3.8 GHz

GRF2370 Evaluation Board S-Pars (Bypass Mode): (1500-3800 MHz Tune)

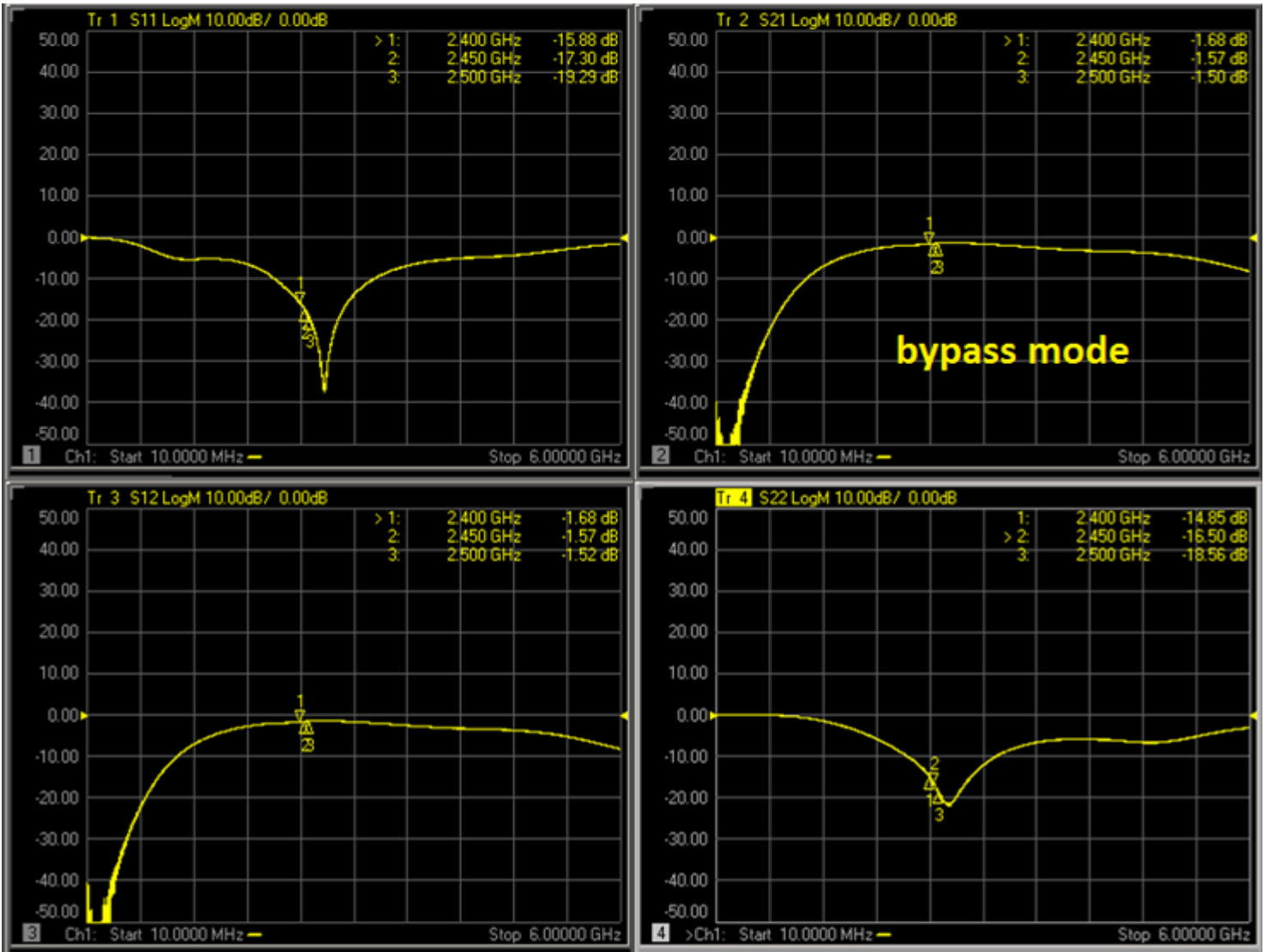

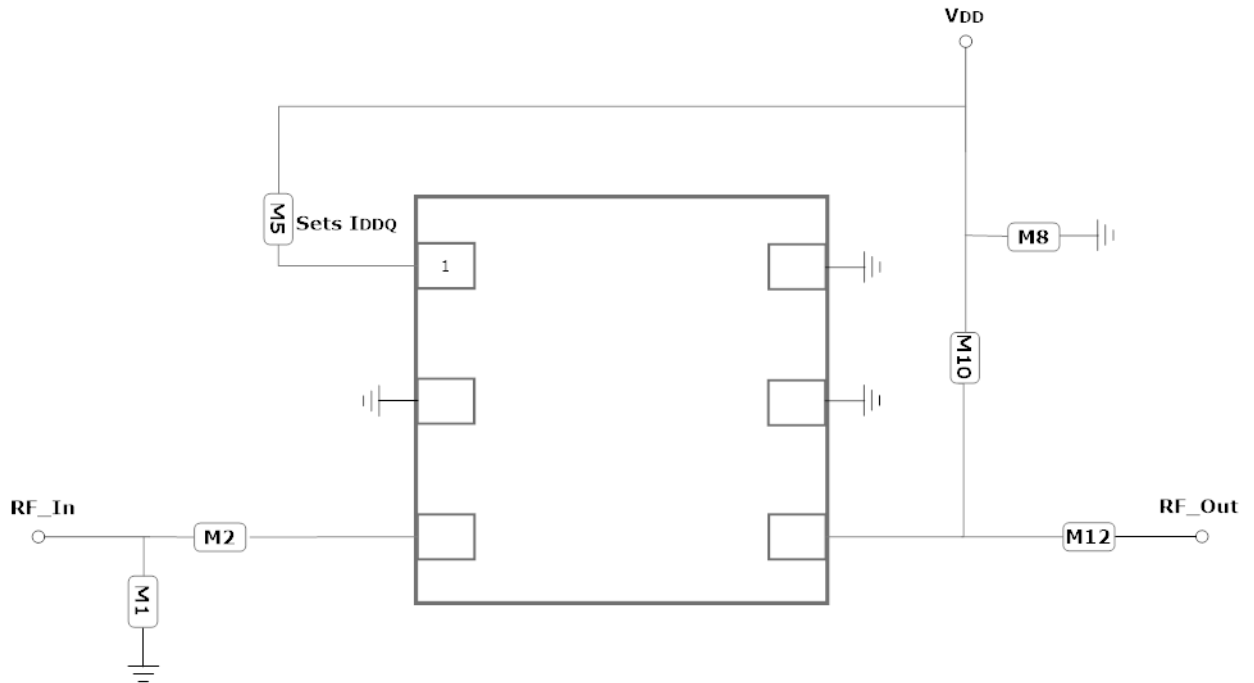

GRF2374 Application Schematic

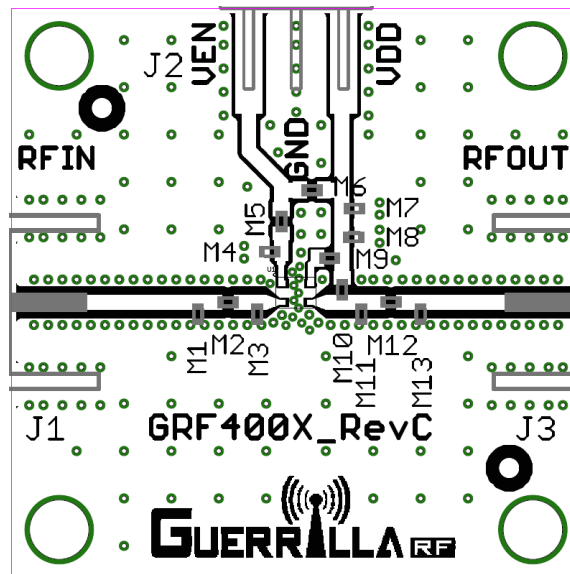

GRF2374 Evaluation Board Assembly Diagram



Preliminary

GRF2374

Low Current LNA w/Bypass
Tuning Range: 0.1 to 3.8 GHz

GRF2374 Standard Evaluation Board BOM: (1.7 to 2.7 GHz Tune)

Component	Type	Manufacturer	Family	Value	Package Size	Substitution
M1	Inductor	Murata	LQG	5.1 nH	0402	Yes
M2	Capacitor	Murata	GJM	3.0 pF	0402	Yes
M5 (Sets Iddq)	Resistor	Various	—	TBD	0402	Yes
M9	Capacitor	Murata	GRM	0.1 uF	0402	Yes
M10	Inductor	Murata	LQG	3.0 nH	0402	Yes
M12	Capacitor	Murata	GJM	2.7 pF	0402	Yes
Evaluation Board:	GRF400X_Rev C					



Preliminary

GRF2374

Low Current LNA w/Bypass
Tuning Range: 0.1 to 3.8 GHz

Data Sheet Release Status:	Notes
Advance	S-parameter and NF data based on EM simulations for the fully packaged device using foundry supplied transistor s-parameters. Linearity estimates based on device size, bias condition and experience with related devices.
Preliminary	All data based on evaluation board measurements in the Guerrilla RF Applications Lab.
Released	All data based on device qualification data. Typically, this data is nearly identical to the data found in the preliminary version. Max and min values for key RF parameters are included.

Information in this datasheet is specific to the Guerrilla RF, Inc. ("Guerrilla RF") product identified.

This datasheet, including the information contained in it, is provided by Guerrilla RF as a service to its customers and may be used for informational purposes only by the customer. Guerrilla RF assumes no responsibility for errors or omissions on this datasheet or the information contained herein. Information provided is believed to be accurate and reliable, however, no responsibility is assumed by Guerrilla RF for its use, nor for any infringement of patents, or other rights of third parties, resulting from its use. Guerrilla RF assumes no liability for any datasheet, datasheet information, materials, products, product information, or other information provided hereunder, including the sale, distribution, reproduction or use of Guerrilla RF products, information or materials.

No license, whether express, implied, by estoppel, by implication or otherwise is granted by this datasheet for any intellectual property of Guerrilla RF, or any third party, including without limitation, patents, patent rights, copyrights, trademarks and trade secrets. All rights are reserved by Guerrilla RF.

All information herein, products, product information, datasheets, and datasheet information are subject to change and availability without notice. Guerrilla RF reserves the right to change component circuitry, recommended application circuitry and specifications at any time without prior notice. Guerrilla RF may further change its datasheet, product information, documentation, products, services, specifications or product descriptions at any time, without notice. Guerrilla RF makes no commitment to update any materials or information and shall have no responsibility whatsoever for conflicts, incompatibilities, or other difficulties arising from any future changes.

GUERRILLA RF INFORMATION, PRODUCTS, PRODUCT INFORMATION, DATASHEETS AND DATASHEET INFORMATION ARE PROVIDED "AS IS" AND WITHOUT WARRANTY OF ANY KIND, WHETHER EXPRESS, IMPLIED, STATUTORY, OR OTHERWISE, INCLUDING FITNESS FOR A PARTICULAR PURPOSE OR USE, MERCHANTABILITY, PERFORMANCE, QUALITY OR NON-INFRINGEMENT OF ANY INTELLECTUAL PROPERTY RIGHT; ALL SUCH WARRANTIES ARE HEREBY EXPRESSLY DISCLAIMED. GUERRILLA RF DOES NOT WARRANT THE ACCURACY OR COMPLETENESS OF THE INFORMATION, TEXT, GRAPHICS OR OTHER ITEMS CONTAINED WITHIN THESE MATERIALS. GUERRILLA RF SHALL NOT BE LIABLE FOR ANY DAMAGES, INCLUDING BUT NOT LIMITED TO ANY SPECIAL, INDIRECT, INCIDENTAL, STATUTORY, OR CONSEQUENTIAL DAMAGES, INCLUDING WITHOUT LIMITATION, LOST REVENUES OR LOST PROFITS THAT MAY RESULT FROM THE USE OF THE MATERIALS OR INFORMATION, WHETHER OR NOT THE RECIPIENT OF MATERIALS HAS BEEN ADVISED OF THE POSSIBILITY OF SUCH DAMAGE.

Customers are solely responsible for their use of Guerrilla RF products in the Customer's products and applications or in ways which deviate from Guerrilla RF's published specifications, either intentionally or as a result of design defects, errors, or operation of products outside of published parameters or design specifications. Customers should include design and operating safeguards to minimize these and other risks. Guerrilla RF assumes no liability or responsibility for applications assistance, customer product design, or damage to any equipment resulting from the use of Guerrilla RF products outside of stated published specifications or parameters.



Компания «ЭлектроПласт» предлагает заключение долгосрочных отношений при поставках импортных электронных компонентов на взаимовыгодных условиях!

Наши преимущества:

- Оперативные поставки широкого спектра электронных компонентов отечественного и импортного производства напрямую от производителей и с крупнейших мировых складов;
- Поставка более 17-ти миллионов наименований электронных компонентов;
- Поставка сложных, дефицитных, либо снятых с производства позиций;
- Оперативные сроки поставки под заказ (от 5 рабочих дней);
- Экспресс доставка в любую точку России;
- Техническая поддержка проекта, помощь в подборе аналогов, поставка прототипов;
- Система менеджмента качества сертифицирована по Международному стандарту ISO 9001;
- Лицензия ФСБ на осуществление работ с использованием сведений, составляющих государственную тайну;
- Поставка специализированных компонентов (Xilinx, Altera, Analog Devices, Intersil, Interpoint, Microsemi, Aeroflex, Peregrine, Syfer, Eurofarad, Texas Instrument, Miteq, Cobham, E2V, MA-COM, Hittite, Mini-Circuits, General Dynamics и др.);

Помимо этого, одним из направлений компании «ЭлектроПласт» является направление «Источники питания». Мы предлагаем Вам помощь Конструкторского отдела:

- Подбор оптимального решения, техническое обоснование при выборе компонента;
- Подбор аналогов;
- Консультации по применению компонента;
- Поставка образцов и прототипов;
- Техническая поддержка проекта;
- Защита от снятия компонента с производства.



Как с нами связаться

Телефон: 8 (812) 309 58 32 (многоканальный)

Факс: 8 (812) 320-02-42

Электронная почта: org@eplast1.ru

Адрес: 198099, г. Санкт-Петербург, ул. Калинина, дом 2, корпус 4, литера А.