

1A High-Speed MOSFET Drivers

Features

- Latch-Up Protected: Withstands 500 mA Reverse Current
- Input Withstands Negative Inputs Up to 5V
- Electrostatic Discharge (ESD) Protected: 2.0 kV (HBM) and 400V (MM)
- High Peak Output Current: 1A
- Wide Input Supply Voltage Operating Range:
 - 4.5V to 16V
- High Capacitive Load Drive Capability:
 - 1000 pF in 25 ns
- Short Delay Time: 30 ns typical
- Matched Delay Times
- Low Supply Current
 - With Logic '1' Input: 500 μ A
 - With Logic '0' Input: 100 μ A
- Low Output Impedance: 8 Ω
- Available in Space-Saving 8-pin MSOP Package
- Pinout – same as TC1410/TC1412/TC1413

Applications

- Switch Mode Power Supplies
- Pulse Transformer Drive
- Line Drivers
- Relay Driver

General Description

The TC1411/TC1411N are 1A CMOS buffers/drivers. They do not latch up under any conditions within their power and voltage ratings. They are not subject to damage when up to 5V of noise spiking of either polarity occurs on the ground pin. They can accept, without damage or logic upset, up to 500 mA of current of either polarity being forced back into their output. All terminals are fully protected against Electrostatic Discharge (ESD) up to 2.0 kV (HBM) and 400V (MM).

As MOSFET drivers, the TC1411/TC1411N can easily charge a 1000 pF gate capacitance in 25 ns with matched rise and fall times. To ensure that the MOSFET's intended state is not affected even by large transients, low enough impedance in both the 'ON' and 'OFF' states are provided. The leading and trailing edge propagation delay times are also matched to allow driving short-duration inputs with greater accuracy.

Package Types



1.0 ELECTRICAL CHARACTERISTICS

Absolute Maximum Ratings †

Supply Voltage	+20V
Input Voltage	$V_{DD} + 0.3V$ to GND – 5.0V
Power Dissipation ($T_A \leq 70^\circ\text{C}$)	
MSOP	340 mW
PDIP	730 mW
SOIC.....	470 mW
Storage Temperature Range	-65°C to +150°C
Maximum Junction Temperature	+150°C

† **Notice:** Stresses above those listed under “Absolute Maximum Ratings” may cause permanent damage to the device. These are stress ratings only and functional operation of the device at these or any other conditions above those indicated in the operation sections of the specifications is not implied. Exposure to Absolute Maximum Rating conditions for extended periods may affect device reliability.

DC CHARACTERISTICS

Electrical Specifications: Unless otherwise noted, over the operating temperature range with $4.5V \leq V_{DD} \leq 16V$. Typical values are measured at $T_A = +25^\circ\text{C}$, $V_{DD} = 16V$.

Parameters	Sym	Min	Typ	Max	Units	Conditions
Input						
Logic '1', High Input Voltage	V_{IH}	2.0	—	—	V	
Logic '0', Low Input Voltage	V_{IL}	—	—	0.8	V	
Input Current	I_{IN}	-1.0	—	1.0	μA	$0V \leq V_{IN} \leq V_{DD}$, $T_A = +25^\circ\text{C}$
		-10	—	10		$-40^\circ\text{C} \leq T_A \leq +85^\circ\text{C}$
Output						
High Output Voltage	V_{OH}	$V_{DD} - 0.025$	—	—	V	DC Test
Low Output Voltage	V_{OL}	—	—	0.025	V	DC Test
Output Resistance	R_O	—	8	11	Ω	$V_{DD} = 16V$, $I_O = 10\text{ mA}$, $T_A = +25^\circ\text{C}$
		—	10	14		$0^\circ\text{C} \leq T_A \leq +70^\circ\text{C}$
		—	10	14		$-40^\circ\text{C} \leq T_A \leq +85^\circ\text{C}$
Peak Output Current	I_{PK}	—	1.0	—	A	$V_{DD} = 16V$
Latch-Up Protection Withstand Reverse Current	I_{REV}	—	0.5	—	A	Duty cycle $\leq 2\%$, $t \leq 300\ \mu\text{s}$, $V_{DD} = 16V$
Switching Time (Note 1)						
Rise Time	t_R	—	25	35	ns	$T_A = +25^\circ\text{C}$
		—	27	40		$0^\circ\text{C} \leq T_A \leq +70^\circ\text{C}$
		—	29	40		$-40^\circ\text{C} \leq T_A \leq +85^\circ\text{C}$, Figure 4-1
Fall Time	t_F	—	25	35	ns	$T_A = +25^\circ\text{C}$
		—	27	40		$0^\circ\text{C} \leq T_A \leq +70^\circ\text{C}$
		—	29	40		$-40^\circ\text{C} \leq T_A \leq +85^\circ\text{C}$, Figure 4-1
Delay Time	t_{D1}	—	30	40	ns	$T_A = +25^\circ\text{C}$
		—	33	45		$0^\circ\text{C} \leq T_A \leq +70^\circ\text{C}$
		—	35	45		$-40^\circ\text{C} \leq T_A \leq +85^\circ\text{C}$, Figure 4-1
Delay Time	t_{D2}	—	30	40	ns	$T_A = +25^\circ\text{C}$
		—	33	45		$0^\circ\text{C} \leq T_A \leq +70^\circ\text{C}$
		—	35	45		$-40^\circ\text{C} \leq T_A \leq +85^\circ\text{C}$, Figure 4-1

Note 1: Switching times ensured by design.

TC1411/TC1411N

DC CHARACTERISTICS (CONTINUED)

Electrical Specifications: Unless otherwise noted, over the operating temperature range with $4.5V \leq V_{DD} \leq 16V$. Typical values are measured at $T_A = +25^\circ C$, $V_{DD} = 16V$.

Parameters	Sym	Min	Typ	Max	Units	Conditions
Power Supply						
Power Supply Current	I_S	—	0.5	1.0	mA	$V_{IN} = 3V, V_{DD} = 16V$
		—	0.1	0.15		$V_{IN} = 0V$

Note 1: Switching times ensured by design.

TEMPERATURE CHARACTERISTICS

Electrical Specifications: Unless otherwise noted, all parameters apply with $4.5V \leq V_{DD} \leq 16V$.

Parameters	Sym	Min	Typ	Max	Units	Conditions
Temperature Ranges						
Specified Temperature Range (C)	T_A	0	—	+70	$^\circ C$	
Specified Temperature Range (E)	T_A	-40	—	+85	$^\circ C$	
Specified Temperature Range (V)	T_A	-40	—	+125	$^\circ C$	
Maximum Junction Temperature	T_J	—	—	+150	$^\circ C$	
Storage Temperature Range	T_A	-65	—	+150	$^\circ C$	
Package Thermal Resistances						
Thermal Resistance, 8L-MSOP	θ_{JA}	—	211	—	$^\circ C/W$	
Thermal Resistance, 8L-PDIP	θ_{JA}	—	89.3	—	$^\circ C/W$	
Thermal Resistance, 8L-SOIC	θ_{JA}	—	149.5	—	$^\circ C/W$	

2.0 TYPICAL PERFORMANCE CURVES

Note: The graphs and tables provided following this note are a statistical summary based on a limited number of samples and are provided for informational purposes only. The performance characteristics listed herein are not tested or guaranteed. In some graphs or tables, the data presented may be outside the specified operating range (e.g., outside specified power supply range) and therefore outside the warranted range.

Note: Unless otherwise indicated, over operating temperature range with $4.5V \leq V_{DD} \leq 16V$.

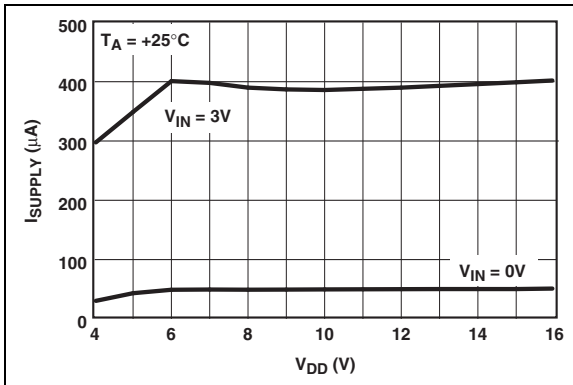

FIGURE 2-1: Quiescent Supply Current vs. Supply Voltage.



FIGURE 2-4: Quiescent Supply Current vs. Temperature.

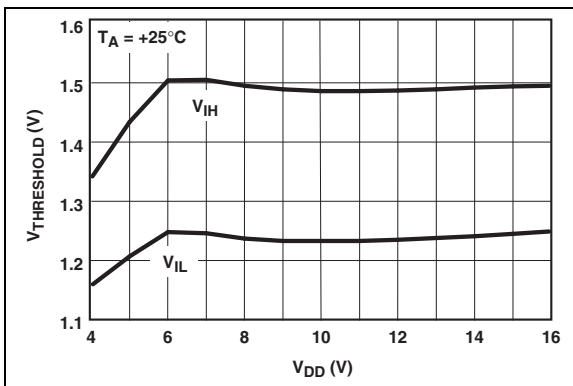

FIGURE 2-2: Input Threshold vs. Supply Voltage.



FIGURE 2-5: Input Threshold vs. Temperature.

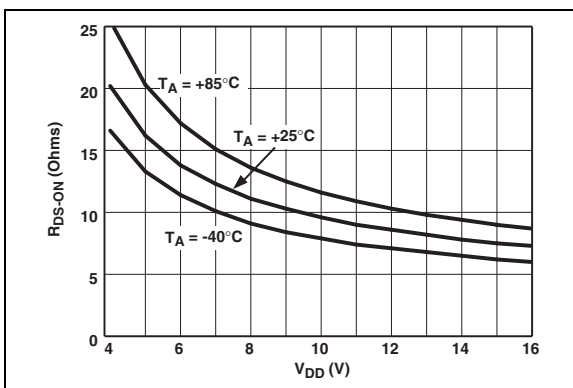

FIGURE 2-3: High-State Output Resistance vs. Supply Voltage.

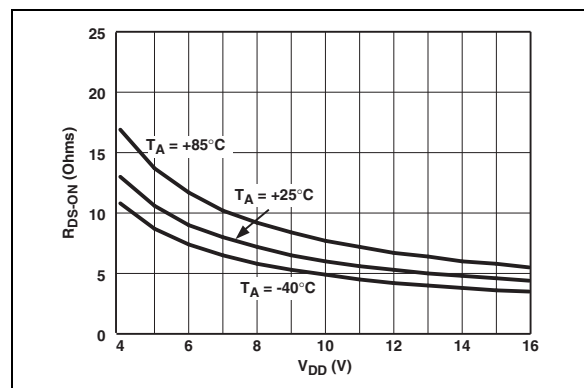

FIGURE 2-6: Low-State Output Resistance vs. Supply Voltage.

TC1411/TC1411N

Note: Unless otherwise indicated, over operating temperature range with $4.5V \leq V_{DD} \leq 16V$.

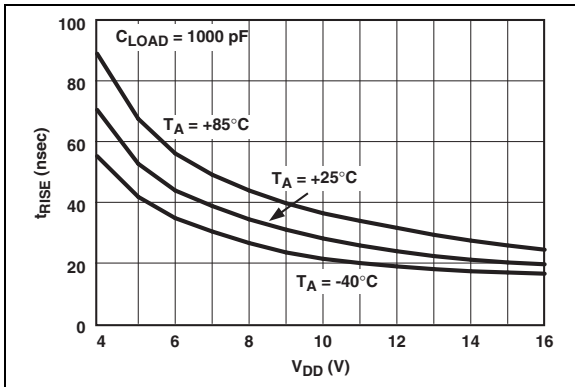

FIGURE 2-7: Rise Time vs. Supply Voltage.

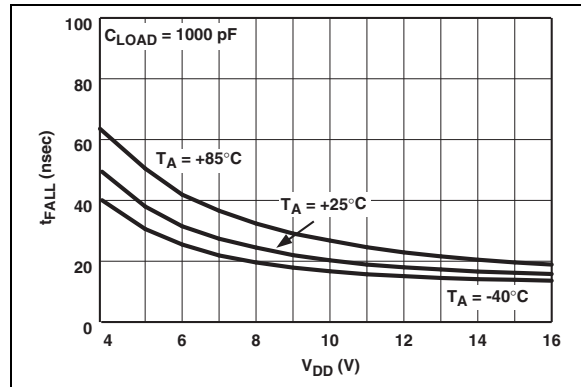

FIGURE 2-10: Fall Time vs. Supply Voltage.

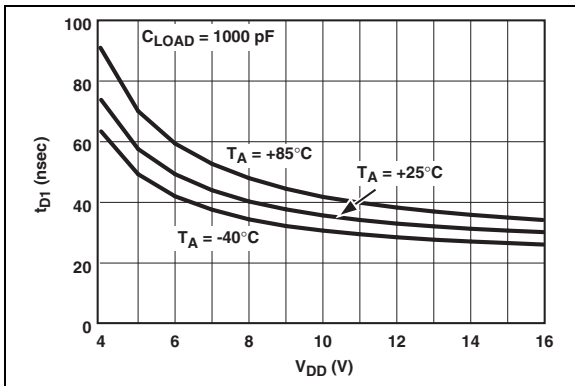

FIGURE 2-8: Propagation Delay vs. Supply Voltage.

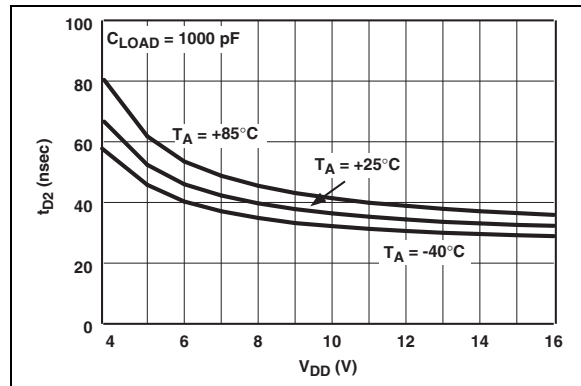

FIGURE 2-11: Propagation Delay vs. Supply Voltage.

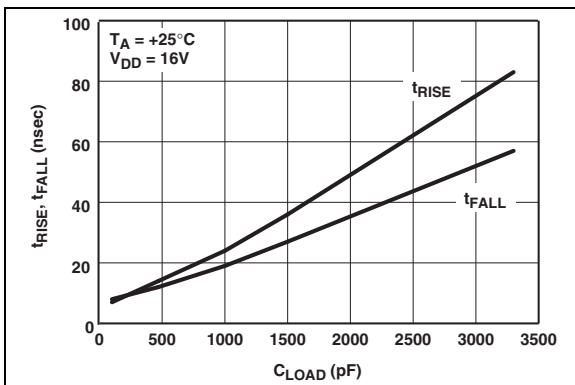

FIGURE 2-9: Rise and Fall Times vs. Capacitive Load.

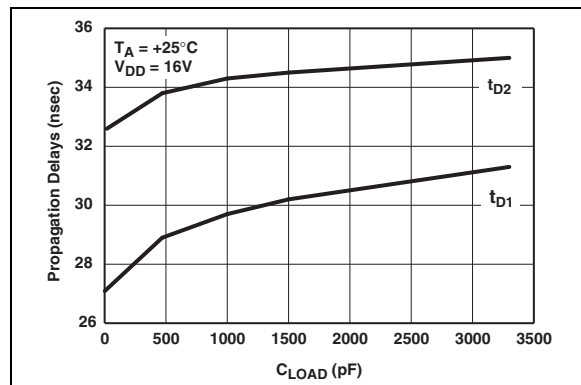

FIGURE 2-12: Propagation Delays vs. Capacitive Load.

3.0 PIN DESCRIPTIONS

The descriptions of the pins are listed in [Table 3-1](#).

TABLE 3-1: PIN FUNCTION TABLE

Pin No.	TC1411 MSOP, PDIP, SOIC	TC1411N MSOP, PDIP, SOIC	Description
1	V _{DD}	V _{DD}	Supply input, 4.5V to 16V
2	IN	IN	Control input
3	NC	NC	No connection
4	GND	GND	Ground
5	GND	GND	Ground
6	$\overline{\text{OUT}}$	OUT	CMOS push-pull output, common to pin 7
7	$\overline{\text{OUT}}$	OUT	CMOS push-pull output, common to pin 6
8	V _{DD}	V _{DD}	Supply input, 4.5V to 16V

3.1 Supply Input (V_{DD})

The V_{DD} input is the bias supply for the MOSFET driver and is rated for 4.5V to 16V with respect to the ground pin. The V_{DD} input should be bypassed to ground with a local ceramic capacitor. The value of the capacitor is chosen based on the capacitive load that is being driven. A value of 1.0 μF is suggested.

3.2 Control Input (IN)

The MOSFET driver input is a high-impedance, TTL/CMOS-compatible input. The input has 300 mV of hysteresis between the high and low thresholds that prevents output glitching even when the rise and fall time of the input signal is very slow.

3.3 CMOS Push-pull Output (OUT, $\overline{\text{OUT}}$)

The MOSFET driver output is a low impedance, CMOS push-pull style output, capable of driving a capacitive load with 1A peak currents.

3.4 Ground (GND)

The ground pins are the return path for the bias current and for the high peak currents which discharge the load capacitor. The ground pins should be tied into a ground plane or have very short traces to the bias supply source return.

3.5 No Connect (NC)

No internal connection.

TC1411/TC1411N

4.0 APPLICATION INFORMATION

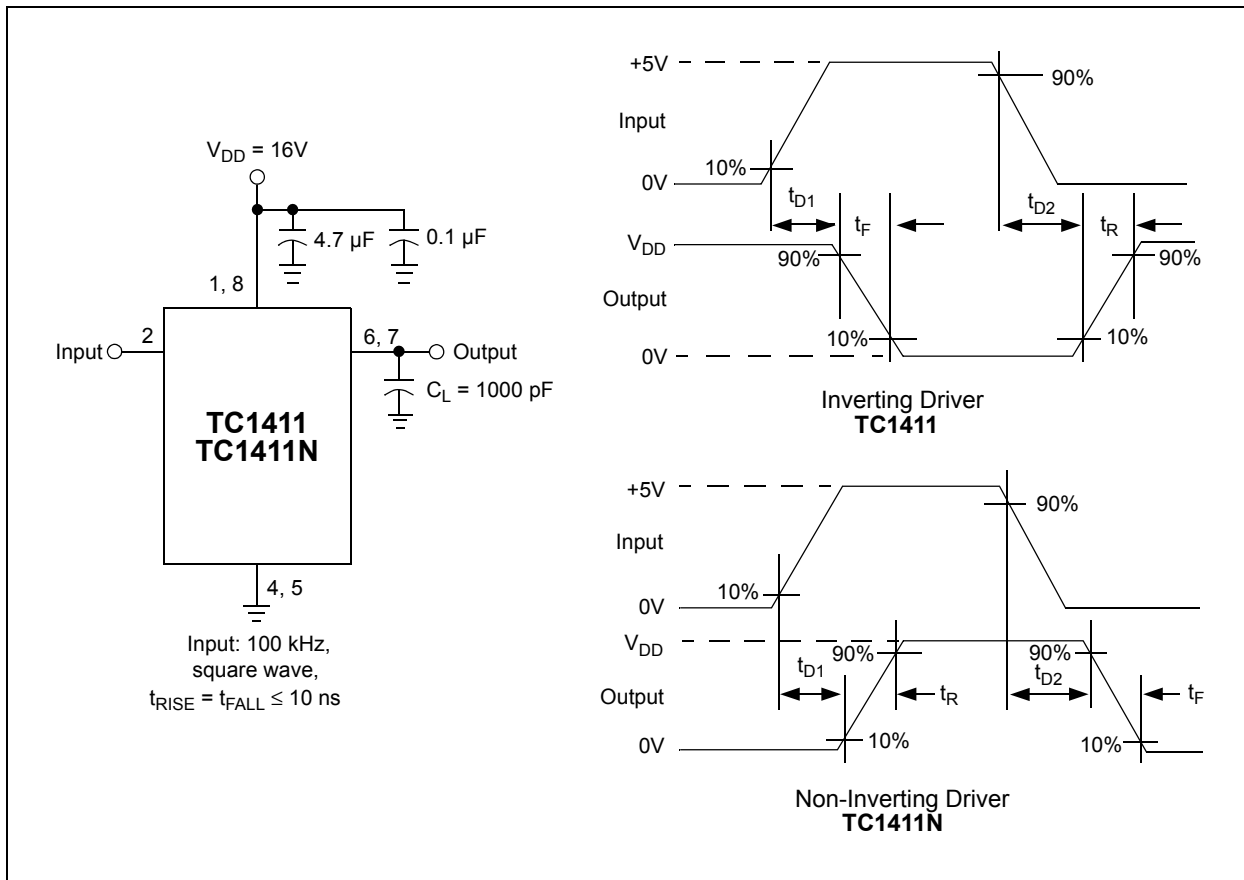

FIGURE 4-1: Switching Time Test Circuit.

5.0 PACKAGING INFORMATION

5.1 Package Marking Information

8-Lead PDIP (300 mil)



Example



OR



Legend:	XX...X	Customer-specific information
	Y	Year code (last digit of calendar year)
	YY	Year code (last 2 digits of calendar year)
	WW	Week code (week of January 1 is week '01')
	NNN	Alphanumeric traceability code
	(e3)	RoHS Compliant JEDEC designator for Matte Tin (Sn)
	*	This package is RoHS Compliant. The RoHS Compliant JEDEC designator ((e3)) can be found on the outer packaging for this package.

Note: In the event the full Microchip part number cannot be marked on one line, it will be carried over to the next line, thus limiting the number of available characters for customer-specific information.

TC1411/TC1411N

8-Lead SOIC (3.90 mm)

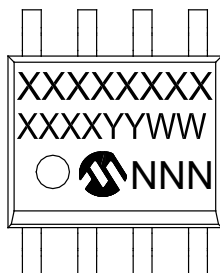

Example

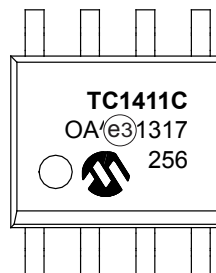

OR

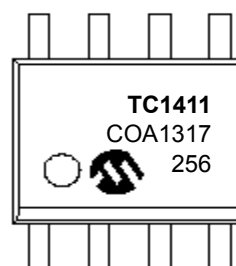

8-Lead MSOP (3x3 mm)

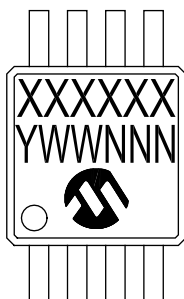

Example

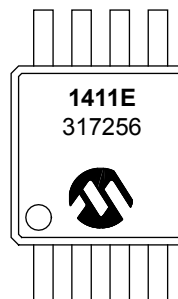

8-Lead Plastic Micro Small Outline Package (UA) [MSOP]

Note: For the most current package drawings, please see the Microchip Packaging Specification located at <http://www.microchip.com/packaging>



Microchip Technology Drawing C04-111C Sheet 1 of 2

TC1411/TC1411N

8-Lead Plastic Micro Small Outline Package (UA) [MSOP]

Note: For the most current package drawings, please see the Microchip Packaging Specification located at <http://www.microchip.com/packaging>



Dimension Limits	Units	MILLIMETERS		
		MIN	NOM	MAX
Number of Pins	N		8	
Pitch	e	0.65 BSC		
Overall Height	A	-	-	1.10
Molded Package Thickness	A2	0.75	0.85	0.95
Standoff	A1	0.00	-	0.15
Overall Width	E	4.90 BSC		
Molded Package Width	E1	3.00 BSC		
Overall Length	D	3.00 BSC		
Foot Length	L	0.40	0.60	0.80
Footprint	L1	0.95 REF		
Foot Angle	ϕ	0°	-	8°
Lead Thickness	c	0.08	-	0.23
Lead Width	b	0.22	-	0.40

Notes:

- Pin 1 visual index feature may vary, but must be located within the hatched area.
- Dimensions D and E1 do not include mold flash or protrusions. Mold flash or protrusions shall not exceed 0.15mm per side.
- Dimensioning and tolerancing per ASME Y14.5M.
 BSC: Basic Dimension. Theoretically exact value shown without tolerances.
 REF: Reference Dimension, usually without tolerance, for information purposes only.

Microchip Technology Drawing C04-111C Sheet 2 of 2

8-Lead Plastic Micro Small Outline Package (UA) [MSOP]

Note: For the most current package drawings, please see the Microchip Packaging Specification located at <http://www.microchip.com/packaging>



RECOMMENDED LAND PATTERN

Dimension Limits	Units	MILLIMETERS		
		MIN	NOM	MAX
Contact Pitch	E	0.65 BSC		
Contact Pad Spacing	C		4.40	
Overall Width	Z			5.85
Contact Pad Width (X8)	X1			0.45
Contact Pad Length (X8)	Y1			1.45
Distance Between Pads	G1	2.95		
Distance Between Pads	GX	0.20		

Notes:

1. Dimensioning and tolerancing per ASME Y14.5M

BSC: Basic Dimension. Theoretically exact value shown without tolerances.

Microchip Technology Drawing No. C04-2111A

TC1411/TC1411N

8-Lead Plastic Dual In-Line (PA) – 300 mil Body [PDIP]

Note: For the most current package drawings, please see the Microchip Packaging Specification located at <http://www.microchip.com/packageing>



Dimension Limits	Units	INCHES		
		MIN	NOM	MAX
Number of Pins	N	8		
Pitch	e	.100 BSC		
Top to Seating Plane	A	–	–	.210
Molded Package Thickness	A2	.115	.130	.195
Base to Seating Plane	A1	.015	–	–
Shoulder to Shoulder Width	E	.290	.310	.325
Molded Package Width	E1	.240	.250	.280
Overall Length	D	.348	.365	.400
Tip to Seating Plane	L	.115	.130	.150
Lead Thickness	c	.008	.010	.015
Upper Lead Width	b1	.040	.060	.070
Lower Lead Width	b	.014	.018	.022
Overall Row Spacing §	eB	–	–	.430

Notes:

- Pin 1 visual index feature may vary, but must be located with the hatched area.
- § Significant Characteristic.
- Dimensions D and E1 do not include mold flash or protrusions. Mold flash or protrusions shall not exceed .010" per side.
- Dimensioning and tolerancing per ASME Y14.5M.
BSC: Basic Dimension. Theoretically exact value shown without tolerances.

Microchip Technology Drawing C04-018B

8-Lead Plastic Small Outline (OA) - Narrow, 3.90 mm Body [SOIC]

Note: For the most current package drawings, please see the Microchip Packaging Specification located at <http://www.microchip.com/packaging>



Microchip Technology Drawing No. C04-057C Sheet 1 of 2

TC1411/TC1411N

8-Lead Plastic Small Outline (OA) - Narrow, 3.90 mm Body [SOIC]

Note: For the most current package drawings, please see the Microchip Packaging Specification located at <http://www.microchip.com/packaging>



		Units	MILLIMETERS		
Dimension Limits			MIN	NOM	MAX
Number of Pins	N		8		
Pitch	e		1.27 BSC		
Overall Height	A	-	-	-	1.75
Molded Package Thickness	A2		1.25	-	-
Standoff §	A1		0.10	-	0.25
Overall Width	E		6.00 BSC		
Molded Package Width	E1		3.90 BSC		
Overall Length	D		4.90 BSC		
Chamfer (Optional)	h		0.25	-	0.50
Foot Length	L		0.40	-	1.27
Footprint	L1		1.04 REF		
Foot Angle	φ		0°	-	8°
Lead Thickness	c		0.17	-	0.25
Lead Width	b		0.31	-	0.51
Mold Draft Angle Top	α		5°	-	15°
Mold Draft Angle Bottom	β		5°	-	15°

Notes:

1. Pin 1 visual index feature may vary, but must be located within the hatched area.
2. § Significant Characteristic
3. Dimensions D and E1 do not include mold flash or protrusions. Mold flash or protrusions shall not exceed 0.15mm per side.
4. Dimensioning and tolerancing per ASME Y14.5M

BSC: Basic Dimension. Theoretically exact value shown without tolerances.

REF: Reference Dimension, usually without tolerance, for information purposes only.

Microchip Technology Drawing No. C04-057C Sheet 2 of 2

8-Lead Plastic Small Outline (OA) – Narrow, 3.90 mm Body [SOIC]

Note: For the most current package drawings, please see the Microchip Packaging Specification located at <http://www.microchip.com/packaging>



RECOMMENDED LAND PATTERN

Dimension Limits	Units	MILLIMETERS		
		MIN	NOM	MAX
Contact Pitch	E	1.27 BSC		
Contact Pad Spacing	C	5.40		
Contact Pad Width (X8)	X1			0.60
Contact Pad Length (X8)	Y1			1.55

Notes:

1. Dimensioning and tolerancing per ASME Y14.5M

BSC: Basic Dimension. Theoretically exact value shown without tolerances.

Microchip Technology Drawing No. C04-2057A

TC1411/TC1411N

NOTES:

APPENDIX A: REVISION HISTORY

Revision E (June 2013)

The following is the list of modifications:

- Updated the values for Electrostatic Discharge (ESD) in the [Features](#) and [General Description](#) columns.
- Updated the Pin Description table in [Section 3.0, Pin Descriptions](#).
- Updated package marking information and drawings in [Section 5.0, Packaging Information](#).
- Minor grammatical and spelling corrections.

Revision D (September 2006)

- Added -40°C to +125°C temperature range to Temperature Characteristics table and Product Information System page.
- Added disclaimer to package outline drawings.

Revision C (March 2003)

- Added 8-Lead MSOP Package.

Revision B (May 2002)

- Converted TELCOM data sheet for Embedded Control Handbook

Revision A (March 2001)

- Original Release of this Document.

TC1411/TC1411N

NOTES:

PRODUCT IDENTIFICATION SYSTEM

To order or obtain information, e.g., on pricing or delivery, refer to the factory or the listed sales office.

<u>PART NO.</u>	<u>X</u>	<u>/XX</u>	
Device	Temperature Range	Package	
<p>Device: TC1411: 1 A Single MOSFET Driver, Inverting TC1411N: 1 A Single MOSFET Driver, Non-Inverting</p> <p>Temperature Range: C = 0°C to +70°C E = -40°C to +85°C V = -40°C to +125°C</p> <p>Package: OA = Plastic SOIC, (150 mil Body), 8-lead OA713 = Plastic SOIC, (150 mil Body), 8-lead (Tape and Reel) UA = Plastic Micro Small Outline (MSOP), 8-lead * UA713 = Plastic Micro Small Outline (MSOP), 8-lead * (Tape and Reel) PA = Plastic DIP (300 mil Body), 8-lead * MSOP package is only available in E-Temp.</p>			
			<p>Examples:</p> <p>a) TC1411COA: 1A Single MOSFET driver, 8LD SOIC package, 0°C to +70°C.</p> <p>b) TC1411CPA: 1A Single MOSFET driver, 8LD PDIP package, 0°C to +70°C.</p> <p>c) TC1411EUA713: Tape and Reel, 1A Single MOSFET driver, 8LD MSOP package, -40°C to +85°C.</p> <p>d) TC1411VOA713: Tape and Reel, 1A Single MOSFET driver, 8LD SOIC package, -40°C to +125°C.</p> <p>a) TC1411NCPA: 1A Single MOSFET driver, 8LD PDIP package, 0°C to +70°C.</p> <p>b) TC1411NEPA: 1A Single MOSFET driver, 8LD PDIP package, -40°C to +85°C.</p> <p>c) TC1411NEUA: 1A Single MOSFET driver, 8LD MSOP package, -40°C to +85°C.</p> <p>d) TC1411NVPA: 1A Single MOSFET driver, 8LD PDIP package, -40°C to +125°C.</p>

TC1411/TC1411N

NOTES:

THE MICROCHIP WEB SITE

Microchip provides online support via our WWW site at www.microchip.com. This web site is used as a means to make files and information easily available to customers. Accessible by using your favorite Internet browser, the web site contains the following information:

- **Product Support** – Data sheets and errata, application notes and sample programs, design resources, user's guides and hardware support documents, latest software releases and archived software
- **General Technical Support** – Frequently Asked Questions (FAQ), technical support requests, online discussion groups, Microchip consultant program member listing
- **Business of Microchip** – Product selector and ordering guides, latest Microchip press releases, listing of seminars and events, listings of Microchip sales offices, distributors and factory representatives

CUSTOMER CHANGE NOTIFICATION SERVICE

Microchip's customer notification service helps keep customers current on Microchip products. Subscribers will receive e-mail notification whenever there are changes, updates, revisions or errata related to a specified product family or development tool of interest.

To register, access the Microchip web site at www.microchip.com. Under "Support", click on "Customer Change Notification" and follow the registration instructions.

CUSTOMER SUPPORT

Users of Microchip products can receive assistance through several channels:

- Distributor or Representative
- Local Sales Office
- Field Application Engineer (FAE)
- Technical Support

Customers should contact their distributor, representative or Field Application Engineer (FAE) for support. Local sales offices are also available to help customers. A listing of sales offices and locations is included in the back of this document.

Technical support is available through the web site at: <http://microchip.com/support>

TC1411/TC1411N

NOTES:

Note the following details of the code protection feature on Microchip devices:

- Microchip products meet the specification contained in their particular Microchip Data Sheet.
- Microchip believes that its family of products is one of the most secure families of its kind on the market today, when used in the intended manner and under normal conditions.
- There are dishonest and possibly illegal methods used to breach the code protection feature. All of these methods, to our knowledge, require using the Microchip products in a manner outside the operating specifications contained in Microchip's Data Sheets. Most likely, the person doing so is engaged in theft of intellectual property.
- Microchip is willing to work with the customer who is concerned about the integrity of their code.
- Neither Microchip nor any other semiconductor manufacturer can guarantee the security of their code. Code protection does not mean that we are guaranteeing the product as “unbreakable.”

Code protection is constantly evolving. We at Microchip are committed to continuously improving the code protection features of our products. Attempts to break Microchip's code protection feature may be a violation of the Digital Millennium Copyright Act. If such acts allow unauthorized access to your software or other copyrighted work, you may have a right to sue for relief under that Act.

Information contained in this publication regarding device applications and the like is provided only for your convenience and may be superseded by updates. It is your responsibility to ensure that your application meets with your specifications. MICROCHIP MAKES NO REPRESENTATIONS OR WARRANTIES OF ANY KIND WHETHER EXPRESS OR IMPLIED, WRITTEN OR ORAL, STATUTORY OR OTHERWISE, RELATED TO THE INFORMATION, INCLUDING BUT NOT LIMITED TO ITS CONDITION, QUALITY, PERFORMANCE, MERCHANTABILITY OR FITNESS FOR PURPOSE. Microchip disclaims all liability arising from this information and its use. Use of Microchip devices in life support and/or safety applications is entirely at the buyer's risk, and the buyer agrees to defend, indemnify and hold harmless Microchip from any and all damages, claims, suits, or expenses resulting from such use. No licenses are conveyed, implicitly or otherwise, under any Microchip intellectual property rights.

Trademarks

The Microchip name and logo, the Microchip logo, dsPIC, FlashFlex, KEELOQ, KEELOQ logo, MPLAB, PIC, PICmicro, PICSTART, PIC³² logo, rPIC, SST, SST Logo, SuperFlash and UNI/O are registered trademarks of Microchip Technology Incorporated in the U.S.A. and other countries.

FilterLab, Hampshire, HI-TECH C, Linear Active Thermistor, MTP, SEEVAL and The Embedded Control Solutions Company are registered trademarks of Microchip Technology Incorporated in the U.S.A.

Silicon Storage Technology is a registered trademark of Microchip Technology Inc. in other countries.

Analog-for-the-Digital Age, Application Maestro, BodyCom, chipKIT, chipKIT logo, CodeGuard, dsPICDEM, dsPICDEM.net, dsPICworks, dsSPEAK, ECAN, ECONOMONITOR, FanSense, HI-TIDE, In-Circuit Serial Programming, ICSP, Mindi, MiWi, MPASM, MPF, MPLAB Certified logo, MPLIB, MPLINK, mTouch, Omniclient Code Generation, PICC, PICC-18, PICDEM, PICDEM.net, PICkit, PICtail, REAL ICE, rLAB, Select Mode, SQI, Serial Quad I/O, Total Endurance, TSHARC, UniWinDriver, WiperLock, ZENA and Z-Scale are trademarks of Microchip Technology Incorporated in the U.S.A. and other countries.

SQTP is a service mark of Microchip Technology Incorporated in the U.S.A.

GestIC and ULPP are registered trademarks of Microchip Technology Germany II GmbH & Co. KG, a subsidiary of Microchip Technology Inc., in other countries.

All other trademarks mentioned herein are property of their respective companies.

© 2001-2013, Microchip Technology Incorporated, Printed in the U.S.A., All Rights Reserved.

 Printed on recycled paper.

ISBN: 978-1-62077-244-7

QUALITY MANAGEMENT SYSTEM
CERTIFIED BY DNV
== ISO/TS 16949 ==

Microchip received ISO/TS-16949:2009 certification for its worldwide headquarters, design and wafer fabrication facilities in Chandler and Tempe, Arizona; Gresham, Oregon and design centers in California and India. The Company's quality system processes and procedures are for its PIC[®] MCUs and dsPIC[®] DSCs, KEELOQ[®] code hopping devices, Serial EEPROMs, microperipherals, nonvolatile memory and analog products. In addition, Microchip's quality system for the design and manufacture of development systems is ISO 9001:2000 certified.



MICROCHIP

Worldwide Sales and Service

AMERICAS

Corporate Office
2355 West Chandler Blvd.
Chandler, AZ 85224-6199
Tel: 480-792-7200
Fax: 480-792-7277
Technical Support:
<http://www.microchip.com/support>
Web Address:
www.microchip.com

Atlanta
Duluth, GA
Tel: 678-957-9614
Fax: 678-957-1455

Boston
Westborough, MA
Tel: 774-760-0087
Fax: 774-760-0088

Chicago
Itasca, IL
Tel: 630-285-0071
Fax: 630-285-0075

Cleveland
Independence, OH
Tel: 216-447-0464
Fax: 216-447-0643

Dallas
Addison, TX
Tel: 972-818-7423
Fax: 972-818-2924

Detroit
Farmington Hills, MI
Tel: 248-538-2250
Fax: 248-538-2260

Indianapolis
Noblesville, IN
Tel: 317-773-8323
Fax: 317-773-5453

Los Angeles
Mission Viejo, CA
Tel: 949-462-9523
Fax: 949-462-9608

Santa Clara
Santa Clara, CA
Tel: 408-961-6444
Fax: 408-961-6445

Toronto
Mississauga, Ontario,
Canada
Tel: 905-673-0699
Fax: 905-673-6509

ASIA/PACIFIC

Asia Pacific Office
Suites 3707-14, 37th Floor
Tower 6, The Gateway
Harbour City, Kowloon
Hong Kong
Tel: 852-2401-1200
Fax: 852-2401-3431

Australia - Sydney
Tel: 61-2-9868-6733
Fax: 61-2-9868-6755

China - Beijing
Tel: 86-10-8569-7000
Fax: 86-10-8528-2104

China - Chengdu
Tel: 86-28-8665-5511
Fax: 86-28-8665-7889

China - Chongqing
Tel: 86-23-8980-9588
Fax: 86-23-8980-9500

China - Hangzhou
Tel: 86-571-2819-3187
Fax: 86-571-2819-3189

China - Hong Kong SAR
Tel: 852-2943-5100
Fax: 852-2401-3431

China - Nanjing
Tel: 86-25-8473-2460
Fax: 86-25-8473-2470

China - Qingdao
Tel: 86-532-8502-7355
Fax: 86-532-8502-7205

China - Shanghai
Tel: 86-21-5407-5533
Fax: 86-21-5407-5066

China - Shenyang
Tel: 86-24-2334-2829
Fax: 86-24-2334-2393

China - Shenzhen
Tel: 86-755-8864-2200
Fax: 86-755-8203-1760

China - Wuhan
Tel: 86-27-5980-5300
Fax: 86-27-5980-5118

China - Xian
Tel: 86-29-8833-7252
Fax: 86-29-8833-7256

China - Xiamen
Tel: 86-592-2388138
Fax: 86-592-2388130

China - Zhuhai
Tel: 86-756-3210040
Fax: 86-756-3210049

ASIA/PACIFIC

India - Bangalore
Tel: 91-80-3090-4444
Fax: 91-80-3090-4123

India - New Delhi
Tel: 91-11-4160-8631
Fax: 91-11-4160-8632

India - Pune
Tel: 91-20-2566-1512
Fax: 91-20-2566-1513

Japan - Osaka
Tel: 81-6-6152-7160
Fax: 81-6-6152-9310

Japan - Tokyo
Tel: 81-3-6880-3770
Fax: 81-3-6880-3771

Korea - Daegu
Tel: 82-53-744-4301
Fax: 82-53-744-4302

Korea - Seoul
Tel: 82-2-554-7200
Fax: 82-2-558-5932 or
82-2-558-5934

Malaysia - Kuala Lumpur
Tel: 60-3-6201-9857
Fax: 60-3-6201-9859

Malaysia - Penang
Tel: 60-4-227-8870
Fax: 60-4-227-4068

Philippines - Manila
Tel: 63-2-634-9065
Fax: 63-2-634-9069

Singapore
Tel: 65-6334-8870
Fax: 65-6334-8850

Taiwan - Hsin Chu
Tel: 886-3-5778-366
Fax: 886-3-5770-955

Taiwan - Kaohsiung
Tel: 886-7-213-7828
Fax: 886-7-330-9305

Taiwan - Taipei
Tel: 886-2-2508-8600
Fax: 886-2-2508-0102

Thailand - Bangkok
Tel: 66-2-694-1351
Fax: 66-2-694-1350

EUROPE

Austria - Wels
Tel: 43-7242-2244-39
Fax: 43-7242-2244-393

Denmark - Copenhagen
Tel: 45-4450-2828
Fax: 45-4485-2829

France - Paris
Tel: 33-1-69-53-63-20
Fax: 33-1-69-30-90-79

Germany - Munich
Tel: 49-89-627-144-0
Fax: 49-89-627-144-44

Italy - Milan
Tel: 39-0331-742611
Fax: 39-0331-466781

Netherlands - Drunen
Tel: 31-416-690399
Fax: 31-416-690340

Spain - Madrid
Tel: 34-91-708-08-90
Fax: 34-91-708-08-91

UK - Wokingham
Tel: 44-118-921-5869
Fax: 44-118-921-5820

11/29/12

Mouser Electronics

Authorized Distributor

Click to View Pricing, Inventory, Delivery & Lifecycle Information:

Microchip:

[TC1411CPA](#) [TC1411COA](#) [TC1411NCOA713](#) [TC1411NEUA](#) [TC1411NEUA713](#) [TC1411NEOA](#) [TC1411NEPA](#)
[TC1411EPA](#) [TC1411NEOA713](#) [TC1411EUA713](#) [TC1411NCPA](#) [TC1411NCOA](#) [TC1411COA713](#) [TC1411EOA](#)
[TC1411EUA](#) [TC1411NVOA](#) [TC1411NVOA713](#) [TC1411NVPA](#) [TC1411NVUA](#) [TC1411NVUA713](#) [TC1411VOA](#)
[TC1411VOA713](#) [TC1411VPA](#) [TC1411VUA](#) [TC1411VUA713](#) [TC1411EOA713](#)



Компания «ЭлектроПласт» предлагает заключение долгосрочных отношений при поставках импортных электронных компонентов на взаимовыгодных условиях!

Наши преимущества:

- Оперативные поставки широкого спектра электронных компонентов отечественного и импортного производства напрямую от производителей и с крупнейших мировых складов;
- Поставка более 17-ти миллионов наименований электронных компонентов;
- Поставка сложных, дефицитных, либо снятых с производства позиций;
- Оперативные сроки поставки под заказ (от 5 рабочих дней);
- Экспресс доставка в любую точку России;
- Техническая поддержка проекта, помощь в подборе аналогов, поставка прототипов;
- Система менеджмента качества сертифицирована по Международному стандарту ISO 9001;
- Лицензия ФСБ на осуществление работ с использованием сведений, составляющих государственную тайну;
- Поставка специализированных компонентов (Xilinx, Altera, Analog Devices, Intersil, Interpoint, Microsemi, Aeroflex, Peregrine, Syfer, Eurofarad, Texas Instrument, Miteq, Cobham, E2V, MA-COM, Hittite, Mini-Circuits, General Dynamics и др.);

Помимо этого, одним из направлений компании «ЭлектроПласт» является направление «Источники питания». Мы предлагаем Вам помощь Конструкторского отдела:

- Подбор оптимального решения, техническое обоснование при выборе компонента;
- Подбор аналогов;
- Консультации по применению компонента;
- Поставка образцов и прототипов;
- Техническая поддержка проекта;
- Защита от снятия компонента с производства.



Как с нами связаться

Телефон: 8 (812) 309 58 32 (многоканальный)

Факс: 8 (812) 320-02-42

Электронная почта: org@eplast1.ru

Адрес: 198099, г. Санкт-Петербург, ул. Калинина, дом 2, корпус 4, литера А.