

### FEATURES

- DAC update rate up to 12 GSPS (minimum)**
- Direct RF synthesis at 6 GSPS (minimum)**
  - DC to 2.5 GHz in baseband 1× bypass mode
  - DC to 6 GHz in 2× nonreturn-to-zero (NRZ) mode
  - 1.5 GHz to 7.5 GHz in Mix-Mode
- Bypassable interpolation (1× or bypass mode)**
  - 2×, 3×, 4×, 6×, 8×, 12×, 16×, 24×
- Excellent dynamic performance**

### APPLICATIONS

- Broadband communications systems**
  - DOCSIS 3.1 cable modem termination system (CMTS)/video on demand (VOD)/edge quadrature amplitude modulation (EQAM)
- Wireless communications infrastructure**
  - W-CDMA, LTE, LTE-A, point to point
- Instrumentation, automatic test equipment (ATE)**
- Radars and jammers**

### GENERAL DESCRIPTION

The AD9161/AD9162<sup>1</sup> are high performance, 11-bit/16-bit digital-to-analog converters (DACs) that supports data rates to 6 GSPS. The DAC core is based on a quad-switch architecture coupled with a 2× interpolator filter that enables an effective DAC update rate of up to 12 GSPS in some modes. The high dynamic range and bandwidth makes these DACs ideally suited for the most demanding high speed radio frequency (RF) DAC applications.

In baseband mode, wide bandwidth capability combines with high dynamic range to support DOCSIS 3.1 cable infrastructure compliance from the minimum of two carriers to full maximum spectrum of 1.794 GHz. A 2× interpolator filter (FIR85) enables the AD9161/AD9162 to be configured for lower data rates and converter clocking to reduce the overall system power and ease the filtering requirements. In Mix-Mode™ operation, the AD9161/AD9162 can reconstruct RF carriers in the second and third Nyquist zones up to 7.5 GHz while still maintaining exceptional dynamic range. The output current can be programmed from 8 mA to 38.76 mA. The AD9161/AD9162 data interface consists of up to eight JESD204B serializer/deserializer (SERDES) lanes that are programmable in terms of lane speed and number of lanes to enable application flexibility.

A serial peripheral interface (SPI) can configure the AD9161/AD9162 and monitor the status of all registers. The AD9161/AD9162 are offered in an 165-ball, 8.0 mm × 8.0 mm, 0.5 mm pitch, CSP\_BGA package and in an 169-ball, 11 mm × 11 mm, 0.8 mm pitch, CSP\_BGA package, including a leaded ball option for the AD9162.

### PRODUCT HIGHLIGHTS

1. High dynamic range and signal reconstruction bandwidth supports RF signal synthesis of up to 7.5 GHz.
2. Up to eight lanes JESD204B SERDES interface flexible in terms of number of lanes and lane speed.
3. Bandwidth and dynamic range to meet DOCSIS 3.1 compliance with margin.

### FUNCTIONAL BLOCK DIAGRAM

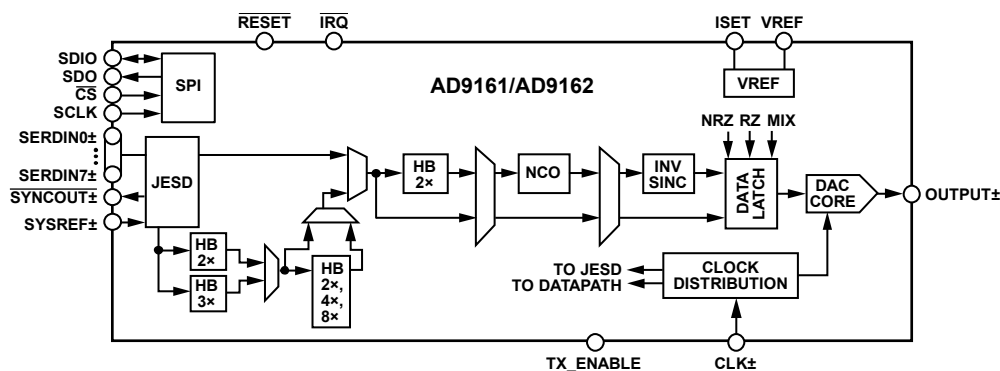

Figure 1.

<sup>1</sup> Protected by U.S. Patents 6,842,132 and 7,796,971.

## TABLE OF CONTENTS

|  |    |                                       |     |
|--|----|---------------------------------------|-----|
| Features .....                                       | 1  | JESD204B Overview .....               | 46  |
| Applications .....                                   | 1  | Physical Layer .....                  | 47  |
| General Description .....                            | 1  | Data Link Layer .....                 | 50  |
| Product Highlights .....                             | 1  | Transport Layer .....                 | 58  |
| Functional Block Diagram .....                       | 1  | JESD204B Test Modes .....             | 60  |
| Revision History .....                               | 3  | JESD204B Error Monitoring .....       | 62  |
| Specifications .....                                 | 4  | Hardware Considerations .....         | 64  |
| DC Specifications .....                              | 4  | Main Digital Datapath .....           | 65  |
| DAC Input Clock Overclocking Specifications .....    | 5  | Data Format .....                     | 65  |
| Power Supply DC Specifications .....                 | 5  | Interpolation Filters .....           | 65  |
| Serial Port and CMOS Pin Specifications .....        | 8  | Digital Modulation .....              | 68  |
| JESD204B Serial Interface Speed Specifications ..... | 9  | Inverse Sinc .....                    | 70  |
| SYSREF± to DAC Clock Timing Specifications .....     | 9  | Downstream Protection .....           | 70  |
| Digital Input Data Timing Specifications .....       | 10 | Datapath PRBS .....                   | 71  |
| JESD204B Interface Electrical Specifications .....   | 10 | Datapath PRBS IRQ .....               | 71  |
| AC Specifications .....                              | 11 | Interrupt Request Operation .....     | 73  |
| Absolute Maximum Ratings .....                       | 13 | Interrupt Service Routine .....       | 73  |
| Reflow Profile .....                                 | 13 | Applications Information .....        | 74  |
| Thermal Management .....                             | 13 | Hardware Considerations .....         | 74  |
| Thermal Resistance .....                             | 13 | Analog Interface Considerations ..... | 77  |
| ESD Caution .....                                    | 13 | Analog Modes of Operation .....       | 77  |
| Pin Configurations and Function Descriptions .....   | 14 | Clock Input .....                     | 78  |
| Typical Performance Characteristics .....            | 18 | Shuffle Mode .....                    | 79  |
| AD9161 .....   | 18 | DLL .....                             | 79  |
| AD9162 .....   | 28 | Voltage Reference .....               | 79  |
| Terminology .....                                    | 42 | Temperature Sensor .....              | 80  |
| Theory of Operation .....                            | 43 | Analog Outputs .....                  | 80  |
| Serial Port Operation .....                          | 44 | Start-Up Sequence .....               | 82  |
| Data Format .....                                    | 44 | Register Summary .....                | 84  |
| Serial Port Pin Descriptions .....                   | 44 | Register Details .....                | 91  |
| Serial Port Options .....                            | 44 | Outline Dimensions .....              | 143 |
| JESD204B Serial Data Interface .....                 | 46 | Ordering Guide .....                  | 144 |

**REVISION HISTORY****5/2019—Rev. C to Rev. D**

|  |     |
|--|-----|
| Changes to INPUTS (SDIO, SCLK, $\overline{\text{CS}}$ , $\overline{\text{RESET}}$ , TX_ENABLE) Parameters, Table 4 ..... | 8   |
| Changes to Table 11 .....  | 13  |
| Change to Figure 30 Caption .....  | 22  |
| Change to Transport Layer Testing Section.....   | 61  |
| Changes to Data Format Section.....  | 65  |
| Deleted Table 38; Renumbered Sequentially .....  | 70  |
| Changes to Changing the Main NCO Frequency Section.....  | 70  |
| Changes to Peak DAC Output Power Capability Section.....   | 80  |
| Changes to Table 42 .....  | 83  |
| Change to Register 0x280 Value Column, Table 43.....   | 84  |
| Changes to Table 45 .....  | 86  |
| Changes to Table 46 .....  | 93  |
| Updated Outline Dimensions.....  | 143 |

**7/2017—Rev. B to Rev. C**

|  |     |
|--|-----|
| Changes to Thermal Management Section and Thermal Resistance Section ..... | 13  |
| Changes to Table 46 .....  | 89  |
| Changes to Table 47 .....  | 134 |

**4/2017—Rev. A to Rev. B**

|  |     |
|--|-----|
| Change to OUTPUT $\pm$ to VNEG_NIP2 Parameter, Table 11.....             | 13  |
| Changes to Figure 153 .....  | 53  |
| Changes to Link Delay Setup Examples, with Known Delays Section .....    | 55  |
| Changes to Link Delay Setup Examples, without Known Delays Section ..... | 56  |
| Changes to Table 31 .....  | 61  |
| Added Datapath PRBS Section.....   | 71  |
| Added Datapath PRBS IRQ Section .....                                    | 72  |
| Changes to Equivalent DAC Output and Transfer Function Section .....     | 80  |
| Changes to Output Stage Configuration Section.....                       | 81  |
| Change to Register 0x230, Table 47 .....                                 | 101 |

**9/2016—Rev. 0 to Rev. A**

|   |     |
|---|-----|
| Changes to Table 1 .....  | 3   |
| Change to AC Specifications Section .....   | 10  |
| Added Reflow Profile Section, Thermal Management Section, and Figure 3, Renumbered Sequentially ..... | 12  |
| Changes to Figure 80 .....  | 30  |
| Changes to Link Delay Setup Example, With Known Delays Section .....                                  | 54  |
| Changes to Table 25 .....   | 57  |
| Moved Figure 188.....   | 77  |
| Added Temperature Sensor Section .....  | 78  |
| Changes to Table 46 .....   | 87  |
| Changes to Table 47 .....   | 99  |
| Changes to Ordering Guide.....  | 139 |

**5/2016—Revision 0: Initial Version**

## SPECIFICATIONS

## DC SPECIFICATIONS

VDD25\_DAC = 2.5 V, VDD12A = VDD12\_CLK = 1.2 V, VNEG\_N1P2 = -1.2 V, DVDD = 1.2 V, IOVDD = 2.5 V, VDD\_1P2 = DVDD\_1P2 = PLL\_LDO\_VDD12 = 1.2 V, SYNC\_VDD\_3P3 = 3.3 V, DAC output full-scale current ( $I_{OUTFS}$ ) = 40 mA, and  $T_A$  = -40°C to +85°C, unless otherwise noted.

Table 1.

| Parameter                            | Test Conditions/Comments   | Min   | Typ   | Max   | Unit   |
|--------------------------------------|--|-------|-------|-------|--------|
| RESOLUTION                           |  | 11    |       |       | Bit    |
| AD9161                               |  |       |       |       |        |
| DAC Update Rate                      |  |       |       |       |        |
| Minimum                              |  |       |       | 1.5   | GSPS   |
| Maximum                              | VDDx <sup>1</sup> = 1.3 V ± 2% <sup>2</sup>  | 6     | 6.4   |       | GSPS   |
| Maximum                              | VDDx <sup>1</sup> = 1.3 V ± 2% <sup>2</sup> , FIR85 <sup>3</sup> 2× interpolator enabled | 12    | 12.8  |       | GSPS   |
| Adjusted <sup>4</sup>                | VDDx <sup>1</sup> = 1.3 V ± 2% <sup>2</sup> , minimum 2× interpolation                   | 3     | 3.2   |       | GSPS   |
| AD9162                               |  | 16    |       |       | Bit    |
| DAC Update Rate                      |  |       |       |       |        |
| Minimum                              |  |       |       | 1.5   | GSPS   |
| Maximum                              | VDDx <sup>1</sup> = 1.3 V ± 2% <sup>2</sup>  | 6     | 6.4   |       | GSPS   |
| Maximum                              | VDDx <sup>1</sup> = 1.3 V ± 2% <sup>2</sup> , FIR85 <sup>3</sup> 2× interpolator enabled | 12    | 12.8  |       | GSPS   |
| Adjusted <sup>4</sup>                | VDDx <sup>1</sup> = 1.3 V ± 2% <sup>2</sup>  | 6     | 6.4   |       | GSPS   |
| ACCURACY                             |  |       |       |       |        |
| Integral Nonlinearity (INL)          |  |       | ±2.7  |       | LSB    |
| Differential Nonlinearity (DNL)      |  |       | ±1.7  |       | LSB    |
| ANALOG OUTPUTS                       |  |       |       |       |        |
| Gain Error (with Internal Reference) |  |       | -1.7  |       | %      |
| Full-Scale Output Current            |  |       |       |       |        |
| Minimum                              | R <sub>SET</sub> = 9.76 kΩ   | 7.37  | 8     | 8.57  | mA     |
| Maximum                              | R <sub>SET</sub> = 9.76 kΩ   | 35.8  | 38.76 | 41.3  | mA     |
| DAC CLOCK INPUT (CLK+, CLK-)         |  |       |       |       |        |
| Differential Input Power             | R <sub>LOAD</sub> = 90 Ω differential on-chip  | -20   | 0     | +10   | dBm    |
| Common-Mode Voltage                  | AC-coupled   |       | 0.6   |       | V      |
| Input Impedance <sup>5</sup>         | 3 GSPS input clock   |       | 90    |       | Ω      |
| TEMPERATURE DRIFT                    |  |       |       |       |        |
| Gain                                 |  |       | 105   |       | ppm/°C |
| Reference Voltage                    |  |       | 75    |       | ppm/°C |
| TEMPERATURE SENSOR                   |  |       |       |       |        |
| Accuracy                             | After one-point calibration (see the Temperature Sensor section)                         |       | ±5    |       | %      |
| REFERENCE                            |  |       |       |       |        |
| Internal Reference Voltage           |  |       | 1.19  |       | V      |
| ANALOG SUPPLY VOLTAGES               |  |       |       |       |        |
| VDD25_DAC                            |  | 2.375 | 2.5   | 2.625 | V      |
| VDD12A <sup>6</sup>                  |  | 1.14  | 1.2   | 1.326 | V      |
| VDD12_CLK <sup>6</sup>               |  | 1.14  | 1.2   | 1.326 | V      |
| VNEG_N1P2                            |  | -1.26 | -1.2  | -1.14 | V      |
| DIGITAL SUPPLY VOLTAGES              |  |       |       |       |        |
| DVDD                                 | Includes VDD12_DCD/DLL   | 1.14  | 1.2   | 1.326 | V      |
| IOVDD <sup>7</sup>                   |  | 1.71  | 2.5   | 3.465 | V      |
| SERDES SUPPLY VOLTAGES               |  |       |       |       |        |
| VDD_1P2                              |  | 1.14  | 1.2   | 1.326 | V      |
| VTT_1P2                              | Can connect to VDD_1P2   | 1.14  | 1.2   | 1.326 | V      |

| Parameter     | Test Conditions/Comments     | Min   | Typ | Max   | Unit |
|---------------|------------------------------|-------|-----|-------|------|
| DVDD_1P2      |                              | 1.14  | 1.2 | 1.326 | V    |
| PLL_LDO_VDD12 |                              | 1.14  | 1.2 | 1.326 | V    |
| PLL_CLK_VDD12 | Can connect to PLL_LDO_VDD12 | 1.14  | 1.2 | 1.326 | V    |
| SYNC_VDD_3P3  |                              | 3.135 | 3.3 | 3.465 | V    |
| BIAS_VDD_1P2  | Can connect to VDD_1P2       | 1.14  | 1.2 | 1.326 | V    |

<sup>1</sup> VDDx is VDD12\_CLK, DVDD, VDD\_1P2, DVDD\_1P2, and PLL\_LDO\_VDD12. Any clock speed over 5.1 GSPS requires a maximum junction temperature of 105°C to avoid damage to the device. See Table 11 for details on maximum junction temperature permitted for certain clock speeds.

<sup>2</sup> See Table 2 for the complete details on the guaranteed speed performance.

<sup>3</sup> FIR85 is the finite impulse response filter with 85 dB digital attenuation that implements 2× NRZ mode.

<sup>4</sup> The adjusted DAC update rate is calculated as  $f_{DAC}$  divided by the minimum required interpolation factor. For the AD9162, the minimum interpolation factor is 1. Therefore, with  $f_{DAC} = 6$  GSPS,  $f_{DAC}$  adjusted = 6 GSPS. For the AD9161, the minimum interpolation is 2×. Therefore, with  $f_{DAC} = 6$  GSPS,  $f_{DAC}$  adjusted = 3 GSPS. When FIR85 is enabled, which puts the device into 2× NRZ mode,  $f_{DAC} = 2 \times$  (DAC clock input frequency), and the minimum interpolation increases to 2× (interpolation value). Thus, for the AD9162, with FIR85 enabled and DAC clock = 6 GSPS,  $f_{DAC} = 12$  GSPS, minimum interpolation = 2×, and the adjusted DAC update rate = 6 GSPS.

<sup>5</sup> See the Clock Input section for more details.

<sup>6</sup> For the lowest noise performance, use a separate power supply filter network for the VDD12\_CLK and the VDD12A pins.

<sup>7</sup> IOVDD can range from 1.8 V to 3.3 V, with ±5% tolerance.

## DAC INPUT CLOCK OVERCLOCKING SPECIFICATIONS

VDD25\_DAC = 2.5 V, VDD12A = VDD12\_CLK = 1.2 V, VNEG\_N1P2 = -1.2 V, DVDD = 1.2 V, IOVDD = 2.5 V, VDD\_1P2 = DVDD\_1P2 = PLL\_LDO\_VDD12 = 1.2 V, SYNC\_VDD\_3P3 = 3.3 V,  $I_{OUTFS} = 40$  mA,  $T_A = -40^\circ\text{C}$  to  $+85^\circ\text{C}$ , unless otherwise noted.

Maximum guaranteed speed using the temperatures and voltages conditions as shown in Table 2, where VDDx is VDD12\_CLK, DVDD, VDD\_1P2, DVDD\_1P2, and PLL\_LDO\_VDD12. Any DAC clock speed over 5.1 GSPS requires a maximum junction temperature of 105°C to avoid damage to the device. See Table 11 for details on maximum junction temperature permitted for certain clock speeds.

Table 2.

| Parameter <sup>1</sup>  | Test Conditions/Comments       | Min | Typ | Max | Unit |
|-------------------------|--------------------------------|-----|-----|-----|------|
| MAXIMUM DAC UPDATE RATE |                                |     |     |     |      |
| VDDx = 1.2 V ± 5%       | $T_{JMAX} = 25^\circ\text{C}$  | 6.0 |     |     | GSPS |
|                         | $T_{JMAX} = 85^\circ\text{C}$  | 5.6 |     |     | GSPS |
|                         | $T_{JMAX} = 105^\circ\text{C}$ | 5.4 |     |     | GSPS |
| VDDx = 1.2 V ± 2%       | $T_{JMAX} = 25^\circ\text{C}$  | 6.1 |     |     | GSPS |
|                         | $T_{JMAX} = 85^\circ\text{C}$  | 5.8 |     |     | GSPS |
|                         | $T_{JMAX} = 105^\circ\text{C}$ | 5.6 |     |     | GSPS |
| VDDx = 1.3 V ± 2%       | $T_{JMAX} = 25^\circ\text{C}$  | 6.4 |     |     | GSPS |
|                         | $T_{JMAX} = 85^\circ\text{C}$  | 6.2 |     |     | GSPS |
|                         | $T_{JMAX} = 105^\circ\text{C}$ | 6.0 |     |     | GSPS |

<sup>1</sup>  $T_{JMAX}$  is the maximum junction temperature.

## POWER SUPPLY DC SPECIFICATIONS

$I_{OUTFS} = 40$  mA,  $T_A = -40^\circ\text{C}$  to  $+85^\circ\text{C}$ , unless otherwise noted. FIR85 is the finite impulse response with 85 dB digital attenuation.

Table 3.

| Parameter                               | Test Conditions/Comments                             | Min  | Typ   | Max | Unit |
|---|--|------|-------|-----|------|
| 8 LANES, 2× INTERPOLATION (80%), 3 GSPS | Numerically controlled oscillator (NCO) on, FIR85 on |      |       |     |      |
| Analog Supply Currents                  |  |      |       |     |      |
| VDD25_DAC = 2.5 V                       |  |      | 93.8  | 100 | mA   |
| VDD12A = 1.2 V                          |  |      | 3.7   | 150 | μA   |
| VDD12_CLK = 1.2 V                       |  |      | 229   | 279 | mA   |
| VNEG_N1P2 = -1.2 V                      |  | -119 | -112  |     | mA   |
| Digital Supply Currents                 |  |      |       |     |      |
| DVDD = 1.2 V                            | Includes VDD12_DCD/DLL                               |      | 621.3 | 971 | mA   |
| IOVDD <sup>1</sup> = 2.5 V              |  |      | 2.5   | 2.7 | mA   |

| Parameter   | Test Conditions/Comments   | Min  | Typ  | Max  | Unit   |
|---|--|------|--|--|--|
| SERDES Supply Currents<br>VDD_1P2 = 1.2 V<br>DVDD_1P2 = 1.2 V<br>PLL_LDO_VDD12 = 1.2 V<br>SYNC_VDD_3P3 = 3.3 V  | Includes VTT_1P2, BIAS_VDD_1P2<br><br>Connected to PLL_CLK_VDD12   |      | 425.5<br>62<br>84.4<br>9.3   | 550<br>86<br>106<br>11   | mA<br>mA<br>mA<br>mA   |
| 8 LANES, 6× INTERPOLATION (80%), 3 GSPS<br>Analog Supply Currents<br>VDD25_DAC = 2.5 V<br>VDD12A = 1.2 V<br>VDD12_CLK = 1.2 V<br>VNEG_N1P2 = -1.2 V<br>Digital Supply Currents<br>DVDD = 1.2 V<br>IOVDD <sup>1</sup> = 2.5 V<br>SERDES Supply Currents<br>VDD_1P2 = 1.2 V<br>DVDD_1P2 = 1.2 V<br>PLL_LDO_VDD12 = 1.2 V<br>SYNC_VDD_3P3 = 3.3 V  | NCO on, FIR85 on<br><br><br><br><br>Includes VDD12_DCD/DLL<br><br>Includes VTT_1P2, BIAS_VDD_1P2<br><br>Connected to PLL_CLK_VDD12   |      | 93.8<br>3.7<br>228.7<br>-120.7<br><br>598.4<br>2.5<br>443.4<br>72.3<br>81.8<br>9.4   |  | mA<br>μA<br>mA<br>mA<br><br>mA<br>mA<br>mA<br>mA                               |
| NCO ONLY MODE, 5 GSPS<br>Analog Supply Currents<br>VDD25_DAC = 2.5 V<br>VDD12A = 1.2 V<br>VDD12_CLK = 1.2 V<br>VNEG_N1P2 = -1.2 V<br>Digital Supply Currents<br>DVDD = 1.2 V<br>IOVDD <sup>1</sup> = 2.5 V<br>SERDES Supply Currents<br>VDD_1P2 = 1.2 V<br>DVDD_1P2 = 1.2 V<br>PLL_LDO_VDD12 = 1.2 V<br>SYNC_VDD_3P3 = 3.3 V  | <br><br><br><br><br>Includes VDD12_DCD/DLL<br><br>Includes VTT_1P2, BIAS_VDD_1P2<br><br>Connected to PLL_CLK_VDD12   | -119 | 93.7<br>10<br>340.6<br>-112<br><br>425.5<br>2.5<br>1.4<br>1.0<br>0.13<br>0.32  | 100<br>150<br>432<br><br>753<br>2.7<br>34<br>14.1<br>1.5<br>0.43                     | mA<br>μA<br>mA<br>mA<br><br>mA<br>mA<br>mA<br>mA                               |
| 8 LANES, 4× INTERPOLATION (80%), 5 GSPS<br>Analog Supply Currents<br>VDD25_DAC = 2.5 V<br>VDD12A = 1.2 V<br>VDD12_CLK = 1.2 V<br><br>VNEG_N1P2 = -1.2 V<br>Digital Supply Currents<br>DVDD = 1.2 V (Includes VDD12_DCD/DLL)<br>DVDD = 1.2 V<br><br>IOVDD <sup>1</sup> = 2.5 V<br>SERDES Supply Currents<br>VDD_1P2 = 1.2 V<br>DVDD_1P2 = 1.2 V<br>PLL_LDO_VDD12 = 1.2 V<br>SYNC_VDD_3P3 = 3.3 V | NCO on, FIR85 off (unless otherwise noted)<br><br><br><br>At 6 GSPS<br><br>NCO on, FIR85 off<br>NCO off, FIR85 on<br>NCO on, FIR85 on<br>NCO on, FIR85 on, at 6 GSPS<br><br>Includes VTT_1P2, BIAS_VDD_1P2<br><br>Connected to PLL_CLK_VDD12 |      | 102<br>80<br>340.5<br>408<br>-127.4<br>-120.2<br><br>665.4<br>706.5<br>894.6<br>1090<br>2.5<br>2.7<br>411.2<br>52.1<br>85.8<br>9.3 | 108<br>150<br>432.4<br><br><br><br>1033<br><br><br><br>2.7<br>550<br>73<br>105<br>11 | mA<br>μA<br>mA<br>mA<br>mA<br><br>mA<br>mA<br>mA<br>mA<br>mA<br>mA<br>mA<br>mA |

| Parameter  | Test Conditions/Comments   | Min | Typ  | Max  | Unit   |
|--|--|-----|--|------|--|
| 8 LANES, 3× INTERPOLATION (80%), 4.5 GSPS<br>Analog Supply Currents<br>VDD25_DAC = 2.5 V<br>VDD12A = 1.2 V<br>VDD12_CLK = 1.2 V<br>VNEG_N1P2 = -1.2 V  | NCO on, FIR85 on   |     | 94<br>85<br>314.3<br>-112.1  | 175  | mA<br>μA<br>mA<br>mA   |
| Digital Supply Currents<br>DVDD = 1.2 V<br>IOVDD <sup>1</sup> = 2.5 V<br>SERDES Supply Currents<br>VDD_1P2 = 1.2 V<br>DVDD_1P2 = 1.2 V<br>PLL_LDO_VDD12 = 1.2 V<br>SYNC_VDD_3P3 = 3.3 V  | Includes VDD12_DCD/DLL<br>IOVDD = 2.5 V<br><br>Includes VTT_1P2, BIAS_VDD_1P2<br><br>Connected to PLL_CLK_VDD12  |     | 948.5<br>2.5<br>432.3<br>62.3<br>84.7<br>9.2   |      | mA<br>mA<br>mA<br>mA<br>mA<br>mA                             |
| POWER DISSIPATION<br>3 GSPS<br>NRZ Mode, 2×, FIR85 Enabled, NCO On<br>2× NRZ Mode, 6×, FIR85 Enabled, NCO On<br>2× NRZ Mode, 4×, FIR85 Enabled, NCO On<br>2× NRZ Mode, 1×, FIR85 Enabled, NCO On<br><br>NRZ Mode, 24×, FIR85 Disabled, NCO On<br>5 GSPS<br>NCO Mode, FIR85 Disabled, NCO On<br>NRZ Mode, 4×, FIR85 Disabled, NCO On<br>2× NRZ Mode, 4×, FIR85 Enabled, NCO Off<br>2× NRZ Mode, 4×, FIR85 Enabled, NCO On<br>NRZ Mode, 8×, FIR85 Disabled, NCO On<br>NRZ Mode, 16×, FIR85 Disabled, NCO On<br>2× NRZ Mode, 6×, FIR85 Enabled, NCO On<br>NRZ Mode, 3×, FIR85 Disabled, NCO On (4.5 GSPS) | Using 80%, 2× filter, eight-lane JESD204B<br>Using 80%, 3× filter, eight-lane JESD204B<br>Using 80%, 2× filter, eight-lane JESD204B<br>1× bypass mode (AD9162 only), eight-lane JESD204B<br><br>Using 80%, 2× filter, one-lane JESD204B<br><br>Using 80%, 2× filter, eight-lane JESD204B<br>Using 80%, 2× filter, eight-lane JESD204B<br>Using 80%, 2× filter, eight-lane JESD204B<br>Using 80%, 2× filter, eight-lane JESD204B<br>Using 80%, 2× filter, eight-lane JESD204B<br>Using 80%, 3× filter, eight-lane JESD204B<br>Using 80%, 3× filter, six-lane JESD204B |     | 2.1<br>2.1<br>2.1<br>1.94<br><br>1.3<br><br>1.3<br>2.3<br>2.35<br>2.58<br>2.18<br>2.09<br>2.65<br>2.62 | 1.83 | W<br>W<br>W<br>W<br><br>W<br>W<br>W<br>W<br>W<br>W<br>W<br>W |

<sup>1</sup> IOVDD can range from 1.8 V to 3.3 V, with ±5% tolerance.

## SERIAL PORT AND CMOS PIN SPECIFICATIONS

VDD25\_DAC = 2.5 V, VDD12A = VDD12\_CLK = 1.2 V, VNEG\_N1P2 = -1.2 V, DVDD = 1.2 V, IOVDD = 2.5 V, VDD\_1P2 = DVDD\_1P2 = PLL\_LDO\_VDD12 = 1.2 V, SYNC\_VDD\_3P3 = 3.3 V, I<sub>OUTFS</sub> = 40 mA, T<sub>A</sub> = -40°C to +85°C, unless otherwise noted.

Table 4.

| Parameter  | Symbol                                  | Test Comments/Conditions              | Min         | Typ | Max         | Unit |
|--|---|---------------------------------------|-------------|-----|-------------|------|
| <b>WRITE OPERATION</b>   |   |                                       |             |     |             |      |
| Maximum SCLK Clock Rate  | f <sub>SCLK</sub> , 1/t <sub>SCLK</sub> | See Figure 142                        | 100         |     |             | MHz  |
| SCLK Clock High  | t <sub>PWH</sub>                        | SCLK = 20 MHz                         | 3.5         |     |             | ns   |
| SCLK Clock Low   | t <sub>PWL</sub>                        | SCLK = 20 MHz                         | 4           |     |             | ns   |
| SDIO to SCLK Setup Time  | t <sub>DS</sub>                         |                                       | 4           | 2   |             | ns   |
| SCLK to SDIO Hold Time   | t <sub>DH</sub>                         |                                       | 1           | 0.5 |             | ns   |
| $\overline{\text{CS}}$ to SCLK Setup Time  | t <sub>S</sub>                          |                                       | 9           | 1   |             | ns   |
| SCLK to $\overline{\text{CS}}$ Hold Time   | t <sub>H</sub>                          |                                       | 9           | 0.5 |             | ns   |
| <b>READ OPERATION</b>  |   |                                       |             |     |             |      |
| SCLK Clock Rate  | f <sub>SCLK</sub> , 1/t <sub>SCLK</sub> | See Figure 141 and Figure 142         |             |     | 20          | MHz  |
| SCLK Clock High  | t <sub>PWH</sub>                        |                                       | 20          |     |             | ns   |
| SCLK Clock Low   | t <sub>PWL</sub>                        |                                       | 20          |     |             | ns   |
| SDIO to SCLK Setup Time  | t <sub>DS</sub>                         |                                       | 10          |     |             | ns   |
| SCLK to SDIO Hold Time   | t <sub>DH</sub>                         |                                       | 5           |     |             | ns   |
| $\overline{\text{CS}}$ to SCLK Setup Time  | t <sub>S</sub>                          |                                       | 10          |     |             | ns   |
| SCLK to SDIO (or SDO) Data Valid Time  | t <sub>DV</sub>                         |                                       |             |     | 17          | ns   |
| $\overline{\text{CS}}$ to SDIO (or SDO) Output Valid to High-Z   |   | Not shown in Figure 141 or Figure 142 |             |     | 45          | ns   |
| <b>INPUTS (SDIO, SCLK, <math>\overline{\text{CS}}</math>, <math>\overline{\text{RESET}}</math>, TX_ENABLE)</b> |   |                                       |             |     |             |      |
| Voltage Input  |   |                                       |             |     |             |      |
| High   | V <sub>IH</sub>                         | 1.8 V ≤ IOVDD ≤ 3.3 V                 | 0.7 × IOVDD |     |             | V    |
| Low  | V <sub>IL</sub>                         | 1.8 V ≤ IOVDD ≤ 3.3 V                 |             |     | 0.3 × IOVDD | V    |
| Current Input  |   |                                       |             |     |             |      |
| High   | I <sub>IH</sub>                         |                                       |             |     | 75          | μA   |
| Low  | I <sub>IL</sub>                         |                                       | -150        |     |             | μA   |
| <b>OUTPUTS (SDIO, SDO)</b>   |   |                                       |             |     |             |      |
| Voltage Output   |   |                                       |             |     |             |      |
| High   | V <sub>OH</sub>                         | 1.8 V ≤ IOVDD ≤ 3.3 V                 | 0.8 × IOVDD |     |             | V    |
| Low  | V <sub>OL</sub>                         | 1.8 V ≤ IOVDD ≤ 3.3 V                 |             |     | 0.2 × IOVDD | V    |
| Current Output   |   |                                       |             |     |             |      |
| High   | I <sub>OH</sub>                         |                                       |             | 4   |             | mA   |
| Low  | I <sub>OL</sub>                         |                                       |             | 4   |             | mA   |



**JESD204B SERIAL INTERFACE SPEED SPECIFICATIONS**

VDD25\_DAC = 2.5 V, VDD12A = VDD12\_CLK = 1.2 V, VNEG\_N1P2 = -1.2 V, DVDD = 1.2 V, IOVDD = 2.5 V, VDD\_1P2 = DVDD\_1P2 = PLL\_LDO\_VDD12 = 1.2 V, SYNC\_VDD\_3P3 = 3.3 V, I<sub>OUTFS</sub> = 40 mA, T<sub>A</sub> = -40°C to +85°C, unless otherwise noted.

Table 5.

| Parameter              | Test Conditions/Comments   | Min   | Typ | Max    | Unit |
|------------------------|----------------------------|-------|-----|--------|------|
| SERIAL INTERFACE SPEED | Guaranteed operating range |       |     |        |      |
| Half Rate              |                            | 6     |     | 12.5   | Gbps |
| Full Rate              |                            | 3     |     | 6.25   | Gbps |
| Oversampling           |                            | 1.5   |     | 3.125  | Gbps |
| 2x Oversampling        |                            | 0.750 |     | 1.5625 | Gbps |

**SYSREF± TO DAC CLOCK TIMING SPECIFICATIONS**

VDD25\_DAC = 2.5 V, VDD12A = VDD12\_CLK = 1.2 V, VNEG\_N1P2 = -1.2 V, DVDD = 1.2 V, IOVDD = 2.5 V, VDD\_1P2 = DVDD\_1P2 = PLL\_LDO\_VDD12 = 1.2 V, SYNC\_VDD\_3P3 = 3.3 V, I<sub>OUTFS</sub> = 40 mA, T<sub>A</sub> = -40°C to +85°C, unless otherwise noted.

Table 6.

| Parameter <sup>1</sup>  | Test Conditions/Comments                 | Min | Typ | Max | Unit |
|---|--|-----|-----|-----|------|
| 8 mm × 8 mm BGA Package (AD9162BBCZ)                            | DC-coupled, common-mode voltage = 1.2 V  |     |     |     |      |
| SYSREF± DIFFERENTIAL SWING = 0.4 V                              |  |     |     |     |      |
| Minimum Setup Time, t <sub>SYSS</sub>                           |  |     | 163 | 424 | ps   |
| Minimum Hold Time, t <sub>SYSH</sub>                            |  |     | 160 | 318 | ps   |
| SYSREF± DIFFERENTIAL SWING = 0.8 V                              |  |     |     |     |      |
| Minimum Setup Time, t <sub>SYSS</sub>                           |  |     | 162 | 412 | ps   |
| Minimum Hold Time, t <sub>SYSH</sub>                            |  |     | 169 | 350 | ps   |
| SYSREF± DIFFERENTIAL SWING = 1.0 V                              |  |     |     |     |      |
| Minimum Setup Time, t <sub>SYSS</sub>                           |  |     | 163 | 376 | ps   |
| Minimum Hold Time, t <sub>SYSH</sub>                            |  |     | 176 | 354 | ps   |
| 11 mm × 11 mm BGA Package (AD9161BBCZ, AD9162BBCAZ, AD9162BBCA) |  |     |     |     |      |
| SYSREF± DIFFERENTIAL SWING = 1.0 V                              |  |     |     |     |      |
| Minimum Setup Time, t <sub>SYSS</sub>                           | AC-coupled                               |     | 65  | 117 | ps   |
|   | DC-coupled, common-mode voltage = 0 V    |     | 45  | 77  | ps   |
|   | DC-coupled, common-mode voltage = 1.25 V |     | 68  | 129 | ps   |
| Minimum Hold Time, t <sub>SYSH</sub>                            | AC-coupled                               |     | 19  | 63  | ps   |
|   | DC-coupled, common-mode voltage = 0 V    |     | 5   | 37  | ps   |
|   | DC-coupled, common-mode voltage = 1.25 V |     | 51  | 114 | ps   |

<sup>1</sup> The SYSREF± pulse must be at least four DAC clock edges wide plus the setup and hold times in Table 6. For more information, see the Sync Processing Modes Overview section.

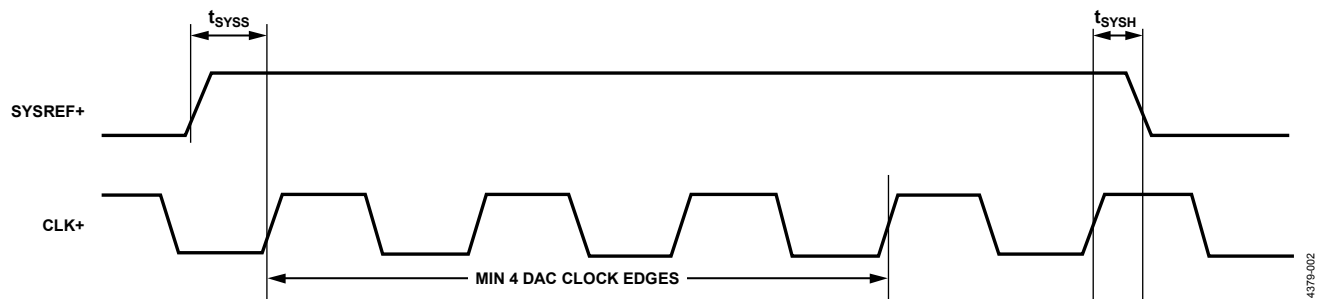

Figure 2. SYSREF± to DAC Clock Timing Diagram (Only SYSREF+ and CLK+ Shown)

**DIGITAL INPUT DATA TIMING SPECIFICATIONS**

VDD25\_DAC = 2.5 V, VDD12A = VDD12\_CLK = 1.2 V, VNEG\_N1P2 = -1.2 V, DVDD = 1.2 V, IOVDD = 2.5 V, VDD\_1P2 = DVDD\_1P2 = PLL\_LDO\_VDD12 = 1.2 V, SYNC\_VDD\_3P3 = 3.3 V, I<sub>OUTFS</sub> = 40 mA, T<sub>A</sub> = -40°C to +85°C, unless otherwise noted.

Table 7.

| Parameter   | Test Conditions/Comments       | Min | Typ          | Max | Unit                     |
|---|--------------------------------|-----|--------------|-----|--------------------------|
| LATENCY <sup>1</sup>  |                                |     |              |     |                          |
| Interface   |                                |     | 1            |     | PCLK <sup>2</sup> cycle  |
| Interpolation   |                                |     | See Table 34 |     |                          |
| Power-Up Time   | From DAC output off to enabled |     | 10           |     | ns                       |
| DETERMINISTIC LATENCY                                       |                                |     |              |     |                          |
| Fixed   |                                |     |              | 12  | PCLK <sup>2</sup> cycles |
| Variable  |                                |     |              | 2   | PCLK <sup>2</sup> cycles |
| SYSREF <sub>±</sub> to LOCAL MULTIFRAME CLOCKS (LMFC) DELAY |                                |     | 4            |     | DAC clock cycles         |

<sup>1</sup> Total latency (or pipeline delay) through the device is calculated as follows:

$$\text{Total Latency} = \text{Interface Latency} + \text{Fixed Latency} + \text{Variable Latency} + \text{Pipeline Delay}$$

See Table 34 for examples of the pipeline delay per block.

<sup>2</sup> PCLK is the internal processing clock for the AD9161/AD9162 and equals the lane rate ÷ 40.

**JESD204B INTERFACE ELECTRICAL SPECIFICATIONS**

VDD25\_DAC = 2.5 V, VDD12A = VDD12\_CLK = 1.2 V, VNEG\_N1P2 = -1.2 V, DVDD = 1.2 V, IOVDD = 2.5 V, VDD\_1P2 = DVDD\_1P2 = PLL\_LDO\_VDD12 = 1.2 V, SYNC\_VDD\_3P3 = 3.3 V, I<sub>OUTFS</sub> = 40 mA, T<sub>A</sub> = -40°C to +85°C, unless otherwise noted. V<sub>TT</sub> is the termination voltage.

Table 8.

| Parameter   | Symbol             | Test Conditions/Comments                                 | Min   | Typ | Max   | Unit |
|---|--------------------|--|-------|-----|-------|------|
| JESD204B DATA INPUTS                                      |                    |  |       |     |       |      |
| Input Leakage Current                                     |                    | T <sub>A</sub> = 25°C                                    |       |     |       |      |
| Logic High  |                    | Input level = 1.2 V ± 0.25 V,<br>V <sub>TT</sub> = 1.2 V |       | 10  |       | μA   |
| Logic Low   |                    | Input level = 0 V  |       | -4  |       | μA   |
| Unit Interval   | UI                 |  | 80    |     | 1333  | ps   |
| Common-Mode Voltage                                       | V <sub>RCM</sub>   | AC-coupled, V <sub>TT</sub> = VDD_1P2 <sup>1</sup>       | -0.05 |     | +1.85 | V    |
| Differential Voltage                                      | R <sub>VDIFF</sub> |  | 110   |     | 1050  | mV   |
| V <sub>TT</sub> Source Impedance                          | Z <sub>TT</sub>    | At dc  |       |     | 30    | Ω    |
| Differential Impedance                                    | Z <sub>RDIFF</sub> | At dc  | 80    | 100 | 120   | Ω    |
| Differential Return Loss                                  | RL <sub>RDIF</sub> |  |       | 8   |       | dB   |
| Common-Mode Return Loss                                   | RL <sub>RCM</sub>  |  |       | 6   |       | dB   |
| SYSREF <sub>±</sub> INPUT                                 |                    |  |       |     |       |      |
| Differential Impedance                                    |                    | 165-ball CSP_BGA (AD9162 only)                           |       | 110 |       | Ω    |
|   |                    | 169-ball CSP_BGA   |       | 121 |       | Ω    |
| DIFFERENTIAL OUTPUTS (SYNCOUT <sub>±</sub> ) <sup>2</sup> |                    | Driving 100 Ω differential load                          |       |     |       |      |
| Output Differential Voltage                               | V <sub>OD</sub>    |  | 350   | 420 | 450   | mV   |
| Output Offset Voltage                                     | V <sub>OS</sub>    |  | 1.15  | 1.2 | 1.27  | V    |

<sup>1</sup> As measured on the input side of the ac coupling capacitor.

<sup>2</sup> IEEE Standard 1596.3 LVDS compatible.

**AC SPECIFICATIONS**

VDD25\_DAC = 2.5 V, VDD12A = VDD12\_CLK = 1.2 V, VNEG\_N1P2 = -1.2 V, DVDD = 1.2 V, IOVDD = 2.5 V, VDD\_1P2 = DVDD\_1P2 = PLL\_LDO\_VDD12 = 1.2 V, SYNC\_VDD\_3P3 = 3.3 V, I<sub>OUTFS</sub> = 40 mA, T<sub>A</sub> = +25°C.

**Table 9. AD9161 Specifications**

| Parameter  | Test Conditions/Comments                      | Min | Typ  | Max | Unit   |
|--|---|-----|------|-----|--------|
| SPURIOUS-FREE DYNAMIC RANGE (SFDR) <sup>1</sup>          | With Marki Microwave BAL-0006SMG <sup>2</sup> |     |      |     |        |
| Single Tone, f <sub>DAC</sub> = 5000 MSPS                |   |     |      |     |        |
| f <sub>OUT</sub> = 70 MHz                                |   |     | -82  |     | dBc    |
| f <sub>OUT</sub> = 500 MHz                               |   |     | -75  |     | dBc    |
| f <sub>OUT</sub> = 1000 MHz                              |   |     | -65  |     | dBc    |
| f <sub>OUT</sub> = 2000 MHz                              |   |     | -70  |     | dBc    |
| f <sub>OUT</sub> = 4000 MHz                              | FIR85 enabled                                 |     | -55  |     | dBc    |
| Single Tone, f <sub>DAC</sub> = 5000 MSPS                | -6 dBFS, shuffle enabled                      |     |      |     |        |
| f <sub>OUT</sub> = 70 MHz                                |   |     | -75  |     | dBc    |
| f <sub>OUT</sub> = 500 MHz                               |   |     | -75  |     | dBc    |
| f <sub>OUT</sub> = 1000 MHz                              |   |     | -70  |     | dBc    |
| f <sub>OUT</sub> = 2000 MHz                              |   |     | -75  |     | dBc    |
| f <sub>OUT</sub> = 4000 MHz                              | FIR85 enabled                                 |     | -50  |     | dBc    |
| Data Over Cable Service Interface Specification (DOCSIS) | f <sub>DAC</sub> = 3076 MSPS                  |     |      |     |        |
| f <sub>OUT</sub> = 70 MHz                                | Single carrier                                |     | -70  |     | dBc    |
| f <sub>OUT</sub> = 70 MHz                                | Four carriers                                 |     | -68  |     | dBc    |
| f <sub>OUT</sub> = 70 MHz                                | Eight carriers                                |     | -65  |     | dBc    |
| f <sub>OUT</sub> = 950 MHz                               | Single carriers                               |     | -70  |     | dBc    |
| f <sub>OUT</sub> = 950 MHz                               | Four carriers                                 |     | -68  |     | dBc    |
| f <sub>OUT</sub> = 950 MHz                               | Eight carriers                                |     | -64  |     | dBc    |
| ADJACENT CHANNEL POWER                                   | f <sub>DAC</sub> = 5000 MSPS                  |     |      |     |        |
| f <sub>OUT</sub> = 877 MHz                               | One carrier, first adjacent channel           |     | -76  |     | dBc    |
| f <sub>OUT</sub> = 877 MHz                               | Two carriers, first adjacent channel          |     | -75  |     | dBc    |
| INTERMODULATION DISTORTION                               | f <sub>DAC</sub> = 5000 MSPS, two-tone test   |     |      |     |        |
| f <sub>OUT</sub> = 900 MHz                               | 0 dBFS  |     | -75  |     | dBc    |
| f <sub>OUT</sub> = 900 MHz                               | -6 dBFS, shuffle enabled                      |     | -80  |     | dBc    |
| f <sub>OUT</sub> = 1800 MHz                              | 0 dBFS  |     | -71  |     | dBc    |
| f <sub>OUT</sub> = 1800 MHz                              | -6 dBFS, shuffle enabled                      |     | -75  |     | dBc    |
| NOISE SPECTRAL DENSITY (NSD)                             |   |     |      |     |        |
| Single Tone, f <sub>DAC</sub> = 5000 MSPS                |   |     |      |     |        |
| f <sub>OUT</sub> = 550 MHz                               |   |     | -157 |     | dBm/Hz |
| f <sub>OUT</sub> = 960 MHz                               |   |     | -155 |     | dBm/Hz |
| f <sub>OUT</sub> = 1990 MHz                              |   |     | -155 |     | dBm/Hz |

<sup>1</sup> See the Clock Input section for more details on optimizing SFDR and reducing the image of the fundamental with clock input tuning.

<sup>2</sup> The Marki Microwave BAL-0006SMG is used on the [AD9162-FMC-EBZ](#) evaluation board.

Table 10. AD9162 Specifications

| Parameter                                       | Test Conditions/Comments   | Min | Typ  | Max | Unit   |
|---|--|-----|------|-----|--------|
| SPURIOUS-FREE DYNAMIC RANGE (SFDR) <sup>1</sup> | With Marki Microwave BAL-0006SMG <sup>2</sup>                          |     |      |     |        |
| Single Tone, $f_{DAC} = 5000$ MSPS              |  |     |      |     |        |
| $f_{OUT} = 70$ MHz                              |  |     | -82  |     | dBc    |
| $f_{OUT} = 500$ MHz                             |  |     | -75  |     | dBc    |
| $f_{OUT} = 1000$ MHz                            |  |     | -65  |     | dBc    |
| $f_{OUT} = 2000$ MHz                            |  |     | -70  |     | dBc    |
| $f_{OUT} = 4000$ MHz                            | FIR85 enabled  |     | -60  |     | dBc    |
| Single Tone, $f_{DAC} = 5000$ MSPS              | -6 dBFS, shuffle enabled   |     |      |     |        |
| $f_{OUT} = 70$ MHz                              |  |     | -75  |     | dBc    |
| $f_{OUT} = 500$ MHz                             |  |     | -75  |     | dBc    |
| $f_{OUT} = 1000$ MHz                            |  |     | -70  |     | dBc    |
| $f_{OUT} = 2000$ MHz                            |  |     | -75  |     | dBc    |
| $f_{OUT} = 4000$ MHz                            | FIR85 enabled  |     | -65  |     | dBc    |
| DOCSIS  | $f_{DAC} = 3076$ MSPS  |     |      |     |        |
| $f_{OUT} = 70$ MHz                              | Single carrier   |     | -70  |     | dBc    |
| $f_{OUT} = 70$ MHz                              | Four carriers  |     | -70  |     | dBc    |
| $f_{OUT} = 70$ MHz                              | Eight carriers   |     | -67  |     | dBc    |
| $f_{OUT} = 950$ MHz                             | Single carriers  |     | -70  |     | dBc    |
| $f_{OUT} = 950$ MHz                             | Four carriers  |     | -68  |     | dBc    |
| $f_{OUT} = 950$ MHz                             | Eight carriers   |     | -64  |     | dBc    |
| Wireless Infrastructure                         | $f_{DAC} = 5000$ MSPS  |     |      |     |        |
| $f_{OUT} = 960$ MHz                             | Two-carrier GSM signal at -9 dBFS;<br>across 925 MHz to 960 MHz band   |     | -85  |     | dBc    |
| $f_{OUT} = 1990$ MHz                            | Two-carrier GSM signal at -9 dBFS;<br>across 1930 MHz to 1990 MHz band |     | -81  |     | dBc    |
| ADJACENT CHANNEL POWER                          | $f_{DAC} = 5000$ MSPS  |     |      |     |        |
| $f_{OUT} = 877$ MHz                             | One carrier, first adjacent channel                                    |     | -79  |     | dBc    |
| $f_{OUT} = 877$ MHz                             | Two carriers, first adjacent channel                                   |     | -76  |     | dBc    |
| $f_{OUT} = 1887$ MHz                            | One carriers, first adjacent channel                                   |     | -74  |     | dBc    |
| $f_{OUT} = 1980$ MHz                            | Four carriers, first adjacent channel                                  |     | -70  |     | dBc    |
| INTERMODULATION DISTORTION                      | $f_{DAC} = 5000$ MSPS, two-tone test                                   |     |      |     |        |
| $f_{OUT} = 900$ MHz                             | 0 dBFS   |     | -80  |     | dBc    |
| $f_{OUT} = 900$ MHz                             | -6 dBFS, shuffle enabled   |     | -80  |     | dBc    |
| $f_{OUT} = 1800$ MHz                            | 0 dBFS   |     | -68  |     | dBc    |
| $f_{OUT} = 1800$ MHz                            | -6 dBFS, shuffle enabled   |     | -78  |     | dBc    |
| NOISE SPECTRAL DENSITY (NSD)                    |  |     |      |     |        |
| Single Tone, $f_{DAC} = 5000$ MSPS              |  |     |      |     |        |
| $f_{OUT} = 550$ MHz                             |  |     | -168 |     | dBm/Hz |
| $f_{OUT} = 960$ MHz                             |  |     | -167 |     | dBm/Hz |
| $f_{OUT} = 1990$ MHz                            |  |     | -164 |     | dBm/Hz |
| SINGLE SIDEBAND (SSB) PHASE NOISE AT OFFSET     | $f_{OUT} = 3800$ MHz, $f_{DAC} = 4000$ MSPS                            |     |      |     |        |
| 1 kHz   |  |     | -119 |     | dBc/Hz |
| 10 kHz  |  |     | -125 |     | dBc/Hz |
| 100 kHz   |  |     | -135 |     | dBc/Hz |
| 1 MHz   |  |     | -144 |     | dBc/Hz |
| 10 MHz  |  |     | -156 |     | dBc/Hz |

<sup>1</sup> See the Clock Input section for more details on optimizing SFDR and reducing the image of the fundamental with clock input tuning.<sup>2</sup> The Marki Microwave BAL-0006SMG is used on the AD9162-FMC-EBZ evaluation board.

## ABSOLUTE MAXIMUM RATINGS

Table 11.

| Parameter   | Rating                                       |
|---|--|
| ISET, VREF to VBG_NEG   | −0.3 V to VDD25_DAC + 0.3 V                  |
| SERDINx±, VTT_1P2,<br>SYNCOUT±  | −0.3 V to SYNC_VDD_3P3 + 0.3 V               |
| OUTPUT± to VNEG_N1P2  | −0.3 V to VDD25_DAC −<br>(VNEG_N1P2) + 0.2 V |
| SYSREF±   | GND − 0.5 V to +2.5 V                        |
| CLK± to Ground  | −0.3 V to VDD12_CLK + 0.3 V                  |
| RESET, IRQ, CS, SCLK, SDIO,<br>SDO to Ground  | −0.3 V to IOVDD + 0.3 V                      |
| Junction Temperature <sup>1</sup>   |  |
| f <sub>DAC</sub> = 6 GSPS   | 105°C  |
| f <sub>DAC</sub> ≤ 5.1 GSPS   | 110°C  |
| Ambient Operating<br>Temperature Range (T <sub>A</sub> )  | −40°C to +85°C                               |
| Storage Temperature Range   | −65°C to +150°C                              |
| VDD12A, VDD12_CLK, DVDD,<br>VDD_1P2, VTT_1P2,<br>DVDD_1P2, PLL_LDO_VDD12,<br>PLL_CLK_VDD12,<br>BIAS_VDD_1P2 to Ground | −0.3 V to +1.326 V                           |
| VDD25_DAC to Ground   | −0.3 V to +2.625 V                           |
| VNEG_N1P2 to Ground   | +0.3 V to −1.26 V                            |
| IOVDD, SYNC_VDD_3P3 to<br>Ground  | −0.3 V to +3.465 V                           |

<sup>1</sup> Some operating modes of the device may cause the device to approach or exceed the maximum junction temperature during operation at supported ambient temperatures. Removal of heat from the device may require additional measures such as active airflow, heat sinks, or other measures.

Stresses at or above those listed under Absolute Maximum Ratings may cause permanent damage to the product. This is a stress rating only; functional operation of the product at these or any other conditions above those indicated in the operational section of this specification is not implied. Operation beyond the maximum operating conditions for extended periods may affect product reliability.

### REFLOW PROFILE

The AD9161/AD9162 reflow profile is in accordance with the JEDEC JESD204B criteria for Pb-free devices. The maximum reflow temperature is 260°C.

### THERMAL MANAGEMENT

The AD9161/AD9162 is a high power device that can dissipate nearly 3 W depending on the user application and configuration. Because of the power dissipation, the AD9161/AD9162 uses an exposed die package to give the customer the most effective method of controlling the die temperature. The exposed die allows cooling of the die directly.

Figure 3 shows the profile view of the device mounted to a user printed circuit board (PCB) and a heat sink (typically the aluminum case) to keep the junction (exposed die) below the maximum junction temperature in Table 11.

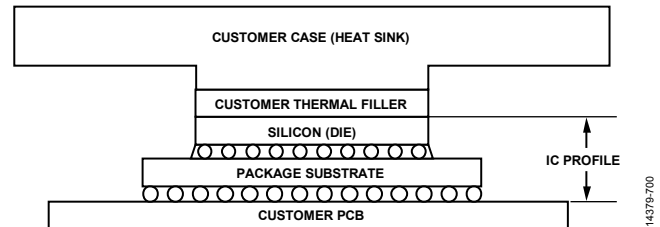

Figure 3. Typical Thermal Management Solution

### THERMAL RESISTANCE

Typical  $\theta_{JA}$  and  $\theta_{JC}$  values are specified for a 4-layer JEDEC 2S2P high effective thermal conductivity test board for ballled surface-mount packages.  $\theta_{JA}$  is obtained in still air conditions (JESD51-2). Airflow increases heat dissipation, effectively reducing  $\theta_{JA}$ .  $\theta_{JC}$  is obtained with the test case temperature monitored at the bottom of the package.

$$\theta_{JA} = \frac{T_J - T_A}{P}$$

$$\theta_{JC} = \frac{T_J - T_C}{P}$$

where:

$\theta_{JA}$  is the natural convection junction-to-ambient air thermal resistance measured in a one-cubic foot sealed enclosure.

$T_J$  is the die junction temperature.

$T_A$  is the ambient temperature in a still air environment.

$P$  is the total power (heat) dissipated in the chip.

$\theta_{JC}$  is the junction-to-case thermal resistance. (In the case of AD9161/AD9162, this is measured at the top of the package on the bare die.)

$T_C$  is the package case temperature. (In the case of AD9161/AD9162, the temperature is measured on the bare die.)

Table 12. Thermal Resistance

| Package Type | $\theta_{JA}$ | $\theta_{JC}$ | Unit |
|--------------|---------------|---------------|------|
| BC-165-1     | 15.4          | 0.04          | °C/W |
| BC-169-2     | 14.6          | 0.02          | °C/W |

### ESD CAUTION



**ESD (electrostatic discharge) sensitive device.** Charged devices and circuit boards can discharge without detection. Although this product features patented or proprietary protection circuitry, damage may occur on devices subjected to high energy ESD. Therefore, proper ESD precautions should be taken to avoid performance degradation or loss of functionality.

### PIN CONFIGURATIONS AND FUNCTION DESCRIPTIONS

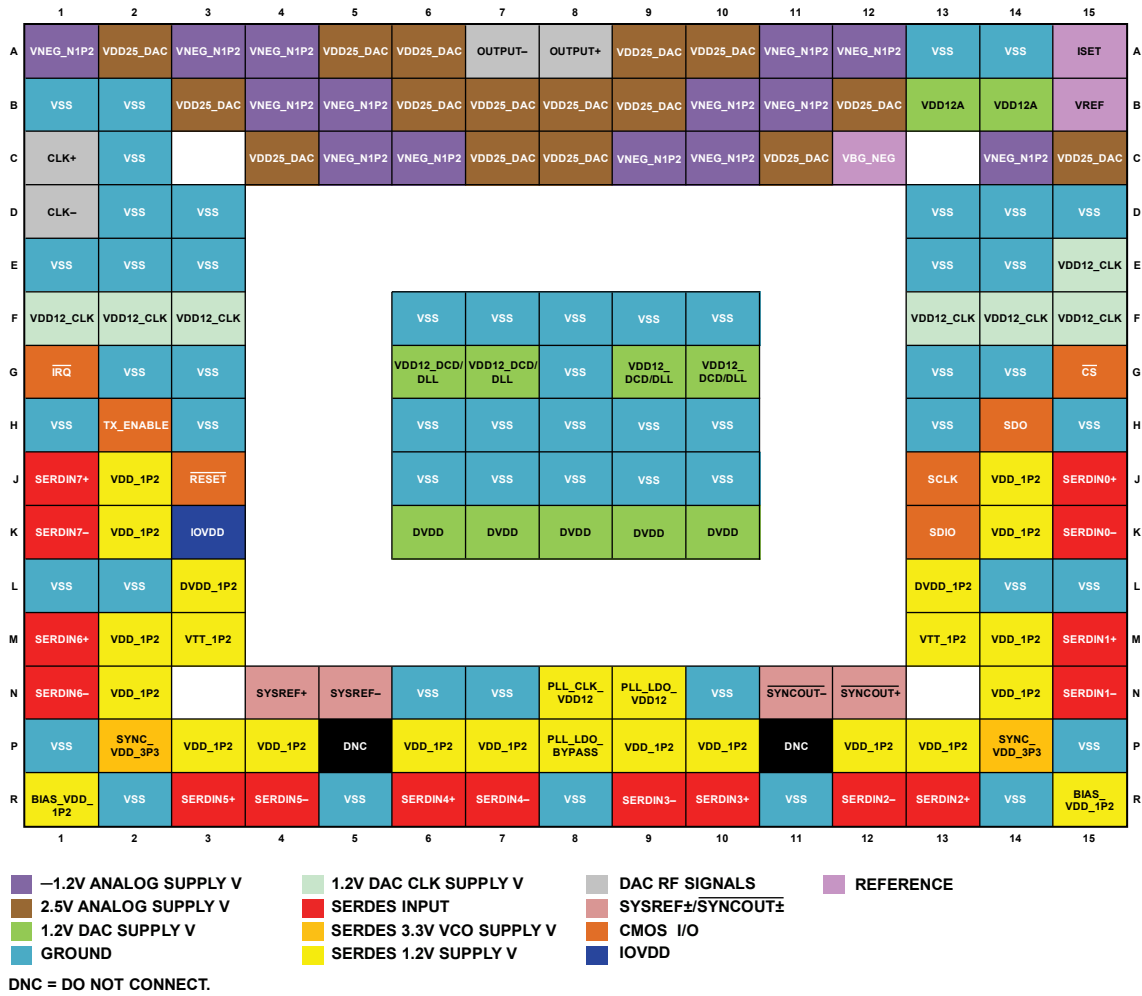
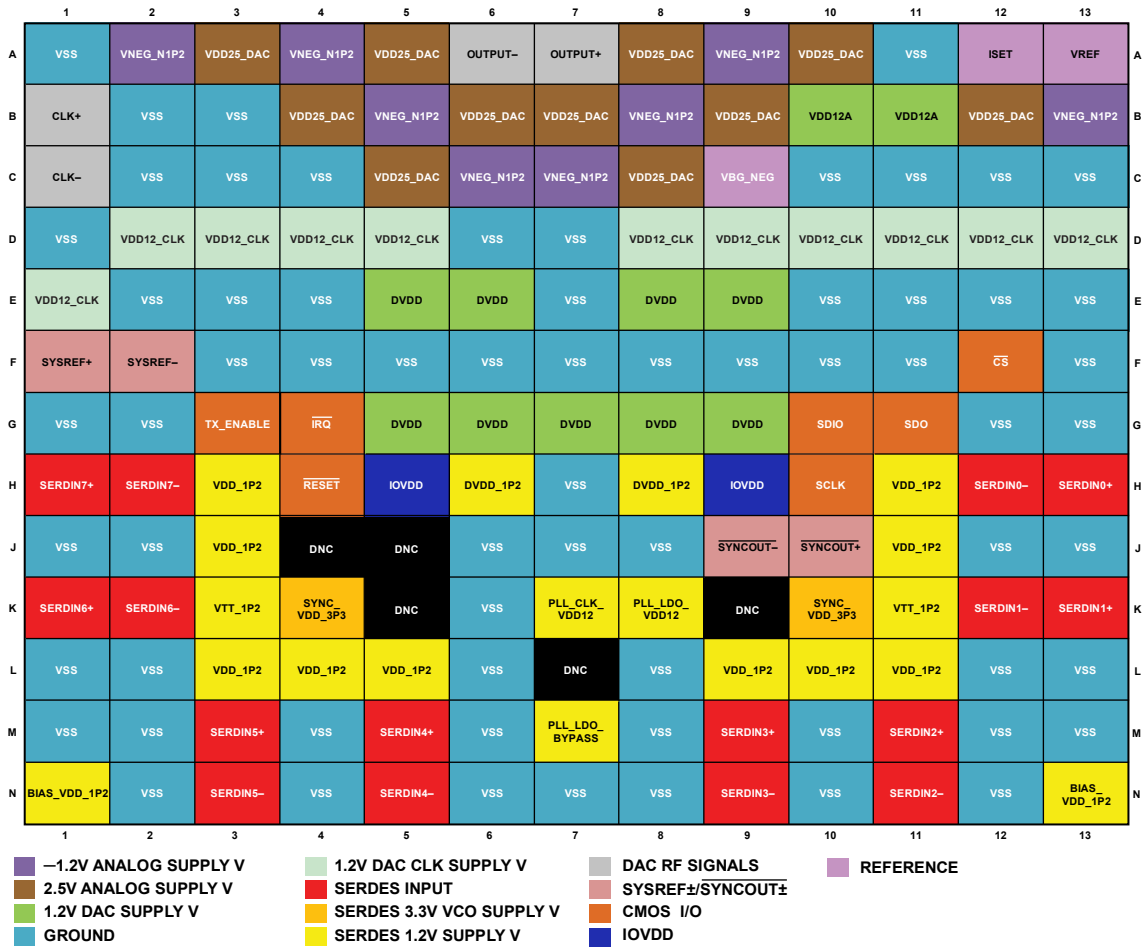

Figure 4. 165-Ball CSP\_BGA Pin Configuration

Table 13. 165-Ball CSP\_BGA Pin Function Descriptions

| Pin No.  | Mnemonic   | Description  |
|--|------------|--|
| A1, A3, A4, A11, A12, B4, B5, B10, B11, C5, C6, C9, C10, C14   | VNEG_N1P2  | -1.2 V Analog Supply Voltage.  |
| A2, A5, A6, A9, A10, B3, B6, B7, B8, B9, B12, C4, C7, C8, C11, C15   | VDD25_DAC  | 2.5 V Analog Supply Voltage.   |
| A7   | OUTPUT-    | DAC Negative Current Output.   |
| A8   | OUTPUT+    | DAC Positive Current Output.   |
| A13, A14, B1, B2, C2, D2, D3, D13, D14, D15, E1, E2, E3, E13, E14, F6, F7, F8, F9, F10, G2, G3, G8, G13, G14, H1, H3, H6, H7, H8, H9, H10, H13, H15, J6, J7, J8, J9, J10, L1, L2, L14, L15, N6, N7, N10, P1, P15, R2, R5, R8, R11, R14 | VSS        | Supply Return. Connect these pins to ground.                                 |
| A15  | ISET       | Reference Current. Connect this pin to VNEG_N1P2 with a 9.6 kΩ resistor.     |
| B13, B14   | VDD12A     | 1.2 V Analog Supply Voltage.   |
| B15  | VREF       | 1.2 V Reference Input/Output. Connect this pin to VSS with a 1 μF capacitor. |
| C1, D1   | CLK+, CLK- | Positive and Negative DAC Clock Inputs.                                      |
| C12  | VBG_NEG    | -1.2 V Reference. Connect this pin to VNEG_N1P2 with a 0.1 μF capacitor.     |
| E15, F1, F2, F3, F13, F14, F15   | VDD12_CLK  | 1.2 V Clock Supply Voltage.  |
| G1   | IRQ        | Interrupt Request Output (Active Low, Open Drain).                           |

| Pin No.   | Mnemonic  | Description   |
|---|---|---|
| G6, G7, G9, G10<br>G15  | VDD12_DCD/DLL<br>$\overline{\text{CS}}$   | 1.2 V Digital Supply Voltage.<br>Serial Port Chip Select Bar (Active Low) Input. CMOS levels on this pin are determined with respect to IOVDD.  |
| H14   | SDO   | Serial Port Data Output. CMOS levels on this pin are determined with respect to IOVDD.  |
| J13   | SCLK  | Serial Port Data Clock. CMOS levels on this pin are determined with respect to IOVDD.   |
| K13   | SDIO  | Serial Port Data Input/Output. CMOS levels on this pin are determined with respect to IOVDD.  |
| J3  | $\overline{\text{RESET}}$   | Reset Bar (Active Low) Input. CMOS levels on this pin are determined with respect to IOVDD.   |
| H2  | TX_ENABLE   | Transmit Enable Input. This pin can be used instead of the DAC output bias power down bits in Register 0x040, Bits [1:0] to enable the DAC output. CMOS levels are determined with respect to IOVDD.    |
| P5, P11<br>J2, J14, K2, K14, M2, M14, N2, N14, P3, P4, P6, P7, P9, P10,<br>P12, P13<br>K3 | DNC<br>VDD_1P2<br>IOVDD   | Do Not Connect. Do not connect to these pins.<br>1.2 V SERDES Digital Supply.<br>Supply Voltage for CMOS Input/Output and SPI. Operational for 1.8 V to 3.3 V plus tolerance (see Table 1 for details). |
| K6, K7, K8, K9, K10<br>L3, L13<br>M3, M13<br>J1, K1                                       | DVDD<br>DVDD_1P2<br>VTT_1P2<br>SERDIN7+,<br>SERDIN7–                            | 1.2 V Digital Supply Voltage.<br>1.2 V SERDES Digital Supply Voltage.<br>1.2 V SERDES $V_{TT}$ Digital Supply Voltage.<br>SERDES Lane 7 Positive and Negative Inputs.                                   |
| M1, N1  | SERDIN6+,<br>SERDIN6–   | SERDES Lane 6 Positive and Negative Inputs.   |
| R3, R4  | SERDIN5+,<br>SERDIN5–   | SERDES Lane 5 Positive and Negative Inputs.   |
| R6, R7  | SERDIN4+,<br>SERDIN4–   | SERDES Lane 4 Positive and Negative Inputs.   |
| R9, R10   | SERDIN3–,<br>SERDIN3+   | SERDES Lane 3 Negative and Positive Inputs.   |
| R12, R13  | SERDIN2–,<br>SERDIN2+   | SERDES Lane 2 Negative and Positive Inputs.   |
| M15, N15  | SERDIN1+,<br>SERDIN1–   | SERDES Lane 1 Positive and Negative Inputs.   |
| J15, K15  | SERDIN0+,<br>SERDIN0–   | SERDES Lane 0 Positive and Negative Inputs.   |
| N4, N5  | SYSREF+, SYSREF–  | System Reference Positive and Negative Inputs. These pins are self biased for ac coupling. They can be ac-coupled or dc-coupled.  |
| N8  | PLL_CLK_VDD12   | 1.2 V SERDES Phase-Locked Loop (PLL) Clock Supply Voltage.  |
| N9<br>N11, N12  | PLL_LDO_VDD12<br>$\overline{\text{SYNCOUT-}}$ ,<br>$\overline{\text{SYNCOUT+}}$ | 1.2 V SERDES PLL Supply.<br>Negative and Positive LVDS Sync (Active Low) Output Signals.  |
| P2, P14<br>P8   | SYNC_VDD_3P3<br>PLL_LDO_BYPASS  | 3.3 V SERDES Sync Supply Voltage.<br>1.2 V SERDES PLL Supply Voltage Bypass.  |
| R1, R15   | BIAS_VDD_1P2  | 1.2 V SERDES Supply Voltage.  |



DNC = DO NOT CONNECT.

Figure 5. 169-Ball CSP\_BGA Pin Configuration

Table 14. 169-Ball CSP\_BGA Pin Function Descriptions

| Pin No.   | Mnemonic         | Description  |
|---|------------------|--|
| A1, A11, B2, B3, C2, C3, C4, C10, C11, C12, C13, D1, D6, D7, E2, E3, E4, E7, E10, E11, E12, E13, F3, F4, F5, F6, F7, F8, F9, F10, F11, F13, G1, G2, G12, G13, H7, J1, J2, J6, J7, J8, J12, J13, K6, L1, L2, L6, L8, L12, L13, M1, M2, M4, M6, M8, M10, M12, M13, N2, N4, N6, N7, N8, N10, N12 | VSS              | Supply Return. Connect these pins to ground.   |
| A2, A4, A9, B5, B8, B13, C6, C7   | VNEG_N1P2        | -1.2 V Analog Supply Voltage.  |
| A3, A5, A8, A10, B4, B6, B7, B9, B12, C5, C8  | VDD25_DAC        | 2.5 V Analog Supply Voltage.   |
| A6  | OUTPUT-          | DAC Negative Current Output.   |
| A7  | OUTPUT+          | DAC Positive Current Output.   |
| A12   | ISET             | Reference Current. Connect this pin to VNEG_N1P2 with a 9.6 kΩ resistor.   |
| A13   | VREF             | 1.2 V Reference Input/Output. Connect this pin to VSS with a 1 μF capacitor.   |
| B1, C1  | CLK+, CLK-       | Positive and Negative DAC Clock Inputs.  |
| B10, B11  | VDD12A           | 1.2 V Analog Supply Voltage.   |
| C9  | VBG_NEG          | -1.2 V Reference. Connect this pin to VNEG_N1P2 with a 0.1 μF capacitor.   |
| D2, D3, D4, D5, D8, D9, D10, D11, D12, D13, E1  | VDD12_CLK        | 1.2 V Clock Supply Voltage.  |
| E5, E6, E8, E9, G5, G6, G7, G8, G9  | DVDD             | 1.2 V Digital Supply Voltage.  |
| F1, F2  | SYSREF+, SYSREF- | System Reference Positive and Negative Inputs. These pins are self biased for ac coupling. They can be ac-coupled or dc-coupled. |



| Pin No.                                    | Mnemonic                            | Description  |
|--|-------------------------------------|--|
| F12  | $\overline{CS}$                     | Serial Port Chip Select Bar (Active Low) Input. CMOS levels on this pin are determined with respect to IOVDD.  |
| G3   | TX_ENABLE                           | Transmit Enable Input. This pin can be used instead of the DAC output bias power down bits in Register 0x040, Bits [1:0] to enable the DAC output. CMOS levels are determined with respect to IOVDD. |
| G4   | $\overline{IRQ}$                    | Interrupt Request Output (Active Low, Open Drain).   |
| G10  | SDIO                                | Serial Port Data Input/Output. CMOS levels on this pin are determined with respect to IOVDD.   |
| G11  | SDO                                 | Serial Port Data Output. CMOS levels on this pin are determined with respect to IOVDD.   |
| H10  | SCLK                                | Serial Port Data Clock. CMOS levels on this pin are determined with respect to IOVDD.  |
| H3, H11, J3, J11, L3, L4, L5, L9, L10, L11 | VDD_1P2                             | 1.2 V SERDES Digital Supply.   |
| H4   | $\overline{RESET}$                  | Reset Bar (Active Low) Input. CMOS levels on this pin are determined with respect to IOVDD.  |
| H5, H9                                     | IOVDD                               | Supply Voltage for CMOS Input/Output and SPI. Operational for 1.8 V to 3.3 V (see Table 1 for details).  |
| H6, H8                                     | DVDD_1P2                            | 1.2 V SERDES Digital Supply Voltage.   |
| H1, H2                                     | SERDIN7+,<br>SERDIN7-               | SERDES Lane 7 Positive and Negative Inputs.  |
| K1, K2                                     | SERDIN6+,<br>SERDIN6-               | SERDES Lane 6 Positive and Negative Inputs.  |
| M3, N3                                     | SERDIN5+,<br>SERDIN5-               | SERDES Lane 5 Positive and Negative Inputs.  |
| M5, N5                                     | SERDIN4+,<br>SERDIN4-               | SERDES Lane 4 Positive and Negative Inputs.  |
| M9, N9                                     | SERDIN3+,<br>SERDIN3-               | SERDES Lane 3 Positive and Negative Inputs.  |
| M11, N11                                   | SERDIN2+,<br>SERDIN2-               | SERDES Lane 2 Positive and Negative Inputs.  |
| K12, K13                                   | SERDIN1-,<br>SERDIN1+               | SERDES Lane 1 Negative and Positive Inputs.  |
| H12, H13                                   | SERDIN0-,<br>SERDIN0+               | SERDES Lane 0 Negative and Positive Inputs.  |
| J4, J5, K5, K9, L7                         | DNC                                 | Do Not Connect. Do not connect to these pins.  |
| J9, J10                                    | $\overline{SYNCOUT-}$ ,<br>SYNCOUT+ | Negative and Positive LVDS Sync (Active Low) Output Signals.   |
| K3, K11                                    | VTT_1P2                             | 1.2 V SERDES $V_{TT}$ Digital Supply Voltage.  |
| K4, K10                                    | SYNC_VDD_3P3                        | 3.3 V SERDES Sync Supply Voltage.  |
| K7   | PLL_CLK_VDD12                       | 1.2 V SERDES PLL Clock Supply Voltage.   |
| K8   | PLL_LDO_VDD12                       | 1.2 V SERDES PLL Supply.   |
| M7   | PLL_LDO_BYPASS                      | 1.2 V SERDES PLL Supply Voltage Bypass.  |
| N1, N13                                    | BIAS_VDD_1P2                        | 1.2 V SERDES Supply Voltage.   |

TYPICAL PERFORMANCE CHARACTERISTICS

AD9161

Static Linearity

$I_{OUTFS} = 40\text{ mA}$ , nominal supplies,  $T_A = 25^\circ\text{C}$ , unless otherwise noted.

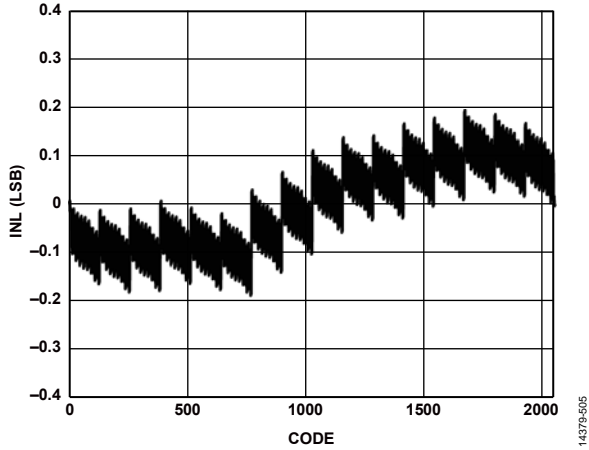

Figure 6. INL,  $I_{OUTFS} = 20\text{ mA}$

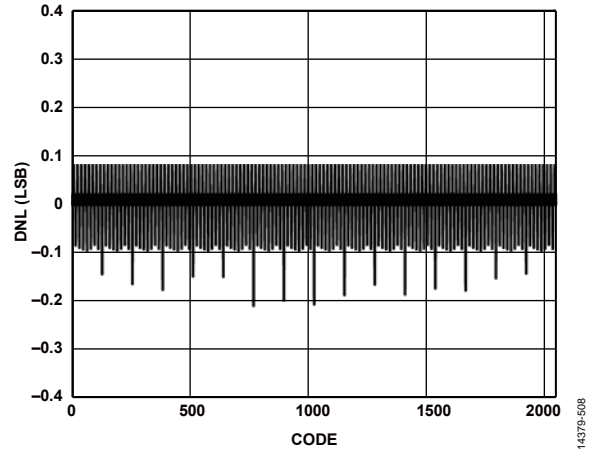

Figure 9. DNL,  $I_{OUTFS} = 20\text{ mA}$

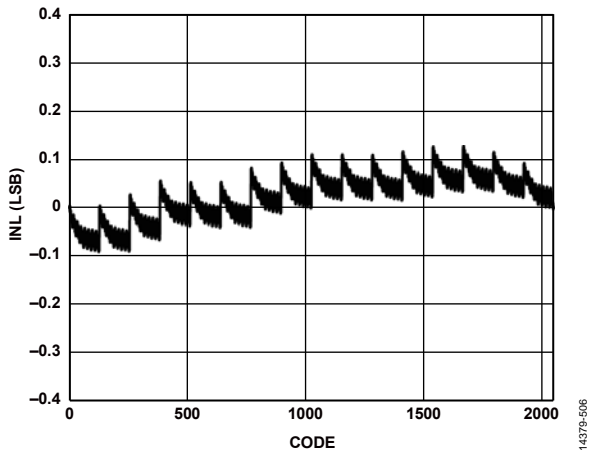

Figure 7. INL,  $I_{OUTFS} = 30\text{ mA}$

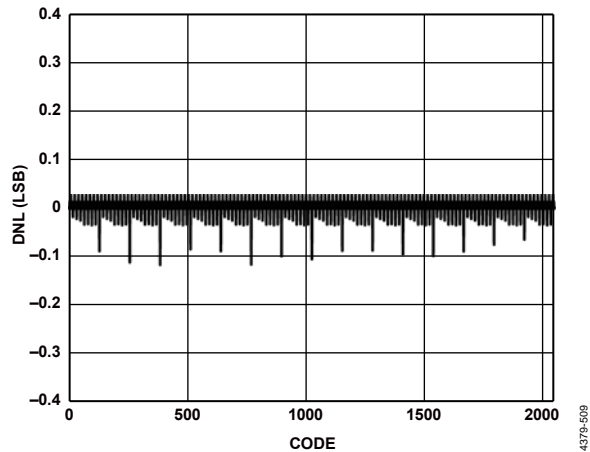

Figure 10. DNL,  $I_{OUTFS} = 30\text{ mA}$

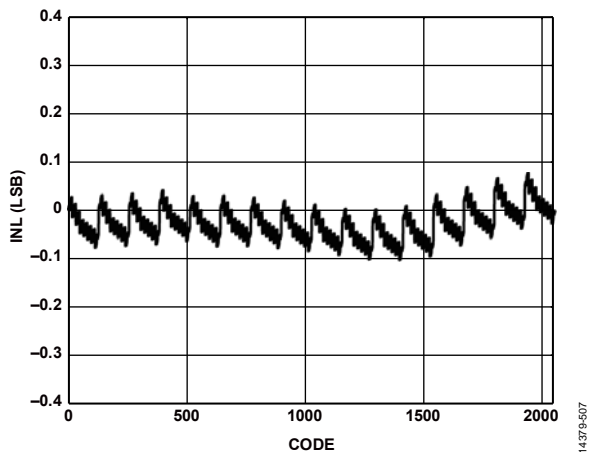

Figure 8. INL,  $I_{OUTFS} = 40\text{ mA}$

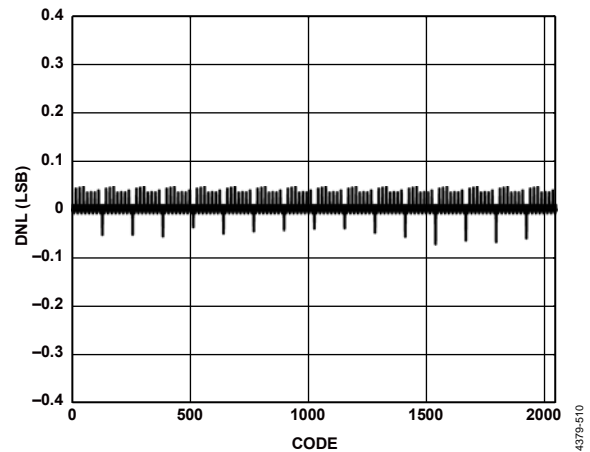

Figure 11. DNL,  $I_{OUTFS} = 40\text{ mA}$

**AC Performance (NRZ Mode)**

$I_{OUTFS} = 40 \text{ mA}$ ,  $f_{DAC} = 5.0 \text{ GSPS}$ , nominal supplies,  $T_A = 25^\circ\text{C}$ , unless otherwise noted.

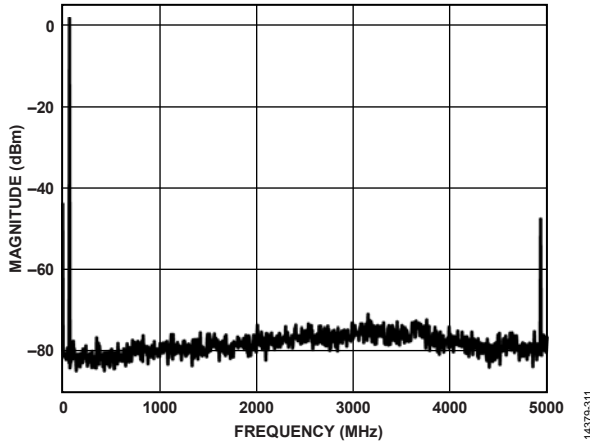

Figure 12. Single-Tone Spectrum at  $f_{OUT} = 70 \text{ MHz}$

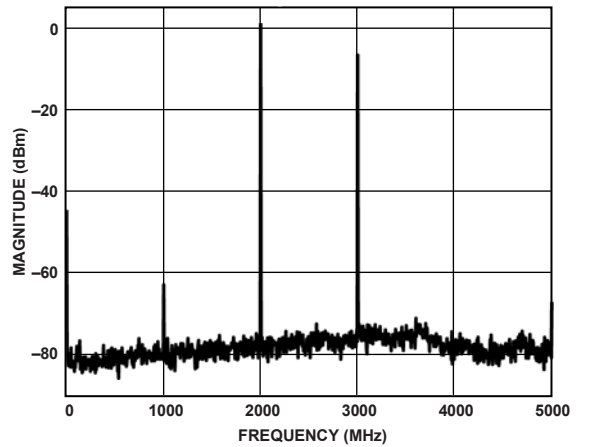

Figure 15. Single-Tone Spectrum at  $f_{OUT} = 2000 \text{ MHz}$

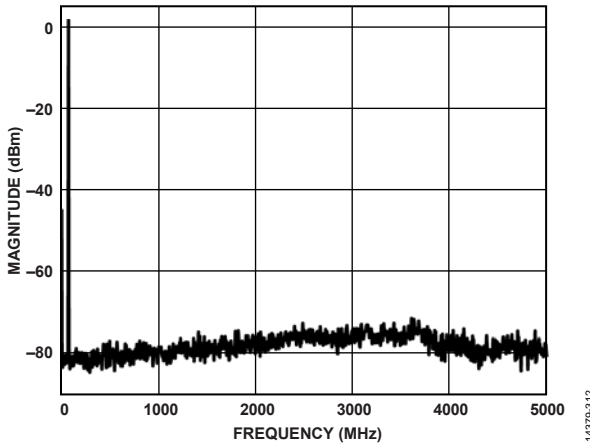

Figure 13. Single-Tone Spectrum at  $f_{OUT} = 70 \text{ MHz}$  (FIR85 Enabled)

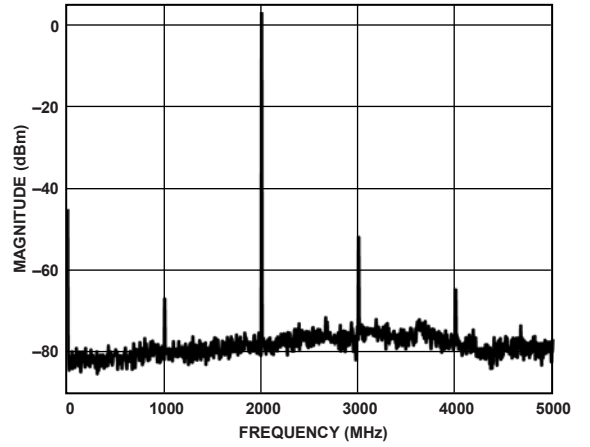

Figure 16. Single-Tone Spectrum at  $f_{OUT} = 2000 \text{ MHz}$  (FIR85 Enabled)

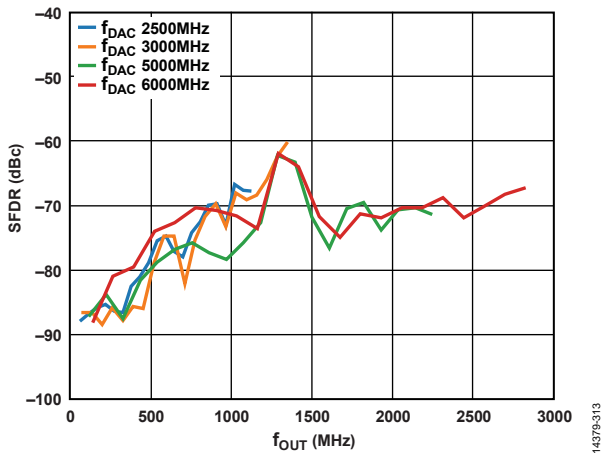

Figure 14. SFDR vs.  $f_{OUT}$  over  $f_{DAC}$

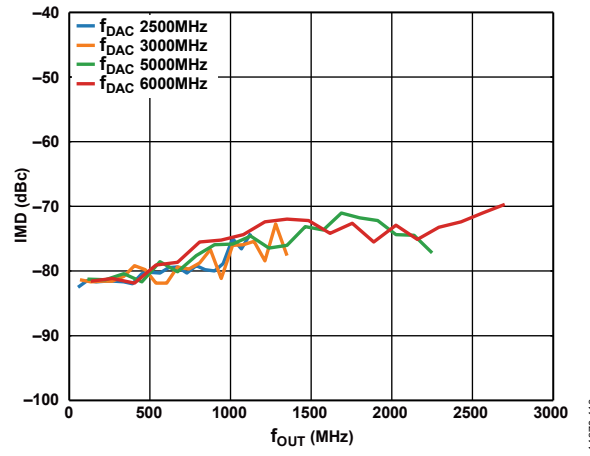

Figure 17. IMD vs.  $f_{OUT}$  over  $f_{DAC}$

$I_{OUTFS} = 40 \text{ mA}$ ,  $f_{DAC} = 5.0 \text{ GSPS}$ , nominal supplies,  $T_A = 25^\circ\text{C}$ , unless otherwise noted.

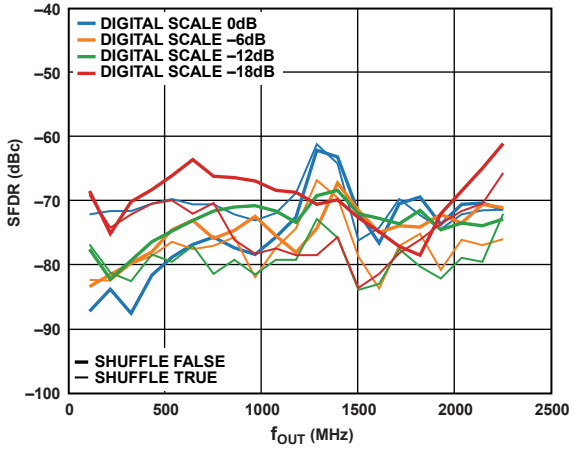

Figure 18. SFDR vs.  $f_{OUT}$  over Digital Full Scale

14379-317

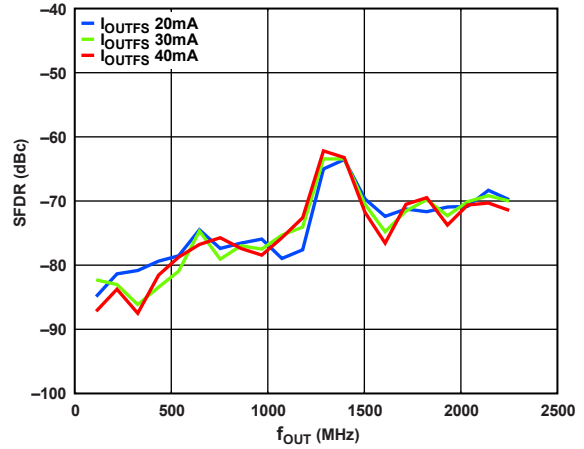

Figure 21. SFDR vs.  $f_{OUT}$  over DAC  $I_{OUTFS}$

14379-322

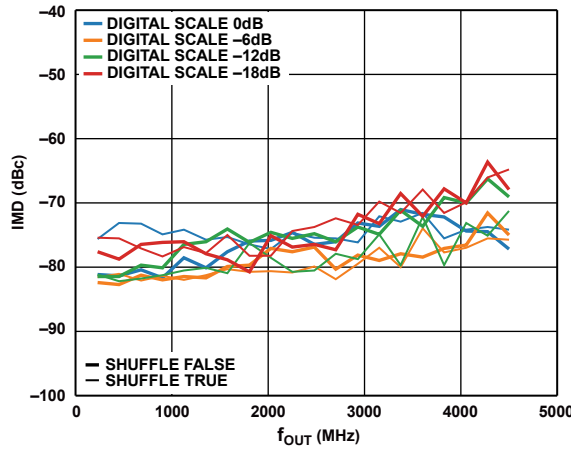

Figure 19. IMD vs.  $f_{OUT}$  over Digital Full Scale

14379-418

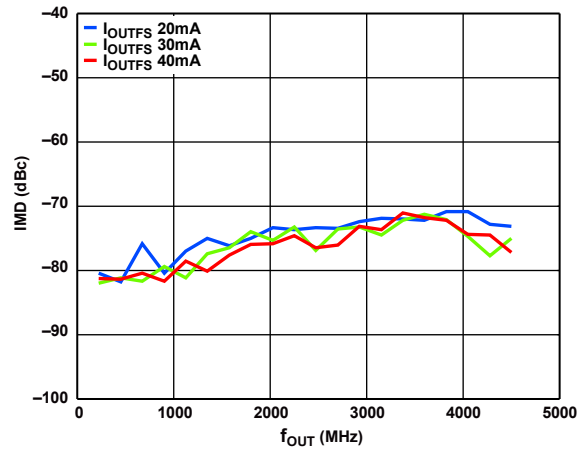

Figure 22. IMD vs.  $f_{OUT}$  over DAC  $I_{OUTFS}$

14379-422

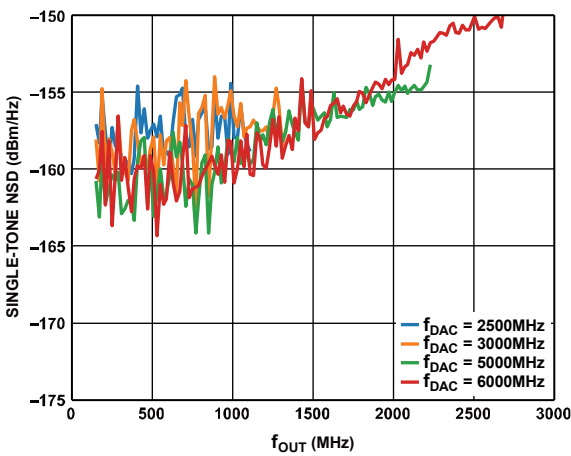

Figure 20. Single-Tone NSD Measured at 70 MHz vs.  $f_{OUT}$  over  $f_{DAC}$

14379-619

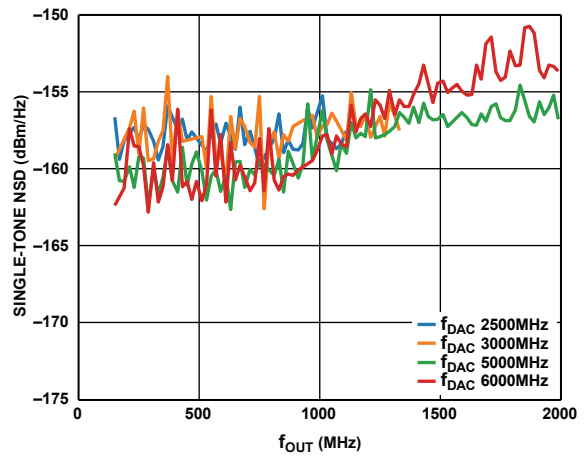

Figure 23. Single-Tone NSD Measured at 10% Offset from  $f_{OUT}$  vs.  $f_{OUT}$  over  $f_{DAC}$

14379-425

$I_{OUTFS} = 40 \text{ mA}$ ,  $f_{DAC} = 5.0 \text{ GSPS}$ , nominal supplies,  $T_A = 25^\circ\text{C}$ , unless otherwise noted.

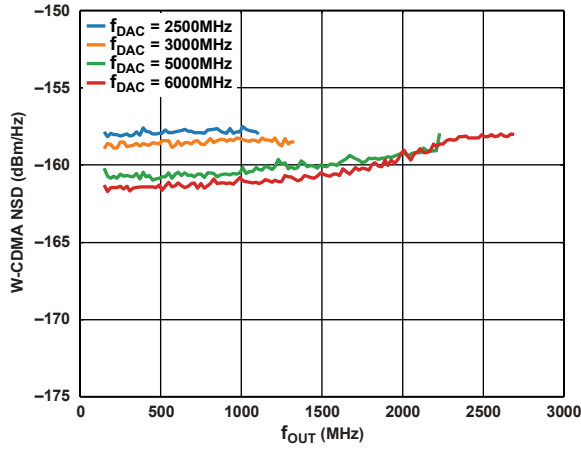

Figure 24. W-CDMA NSD Measured at 70 MHz vs.  $f_{OUT}$  over  $f_{DAC}$

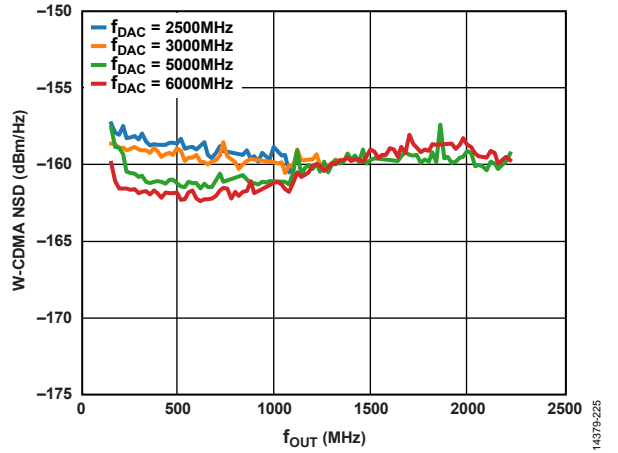

Figure 26. W-CDMA NSD Measured at 10% Offset from  $f_{OUT}$  vs.  $f_{OUT}$  over  $f_{DAC}$

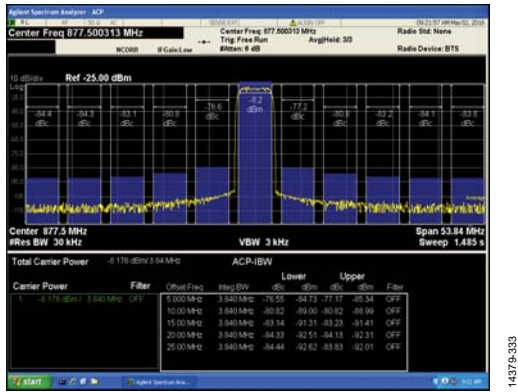

Figure 25. Single-Carrier W-CDMA at 877.5 MHz

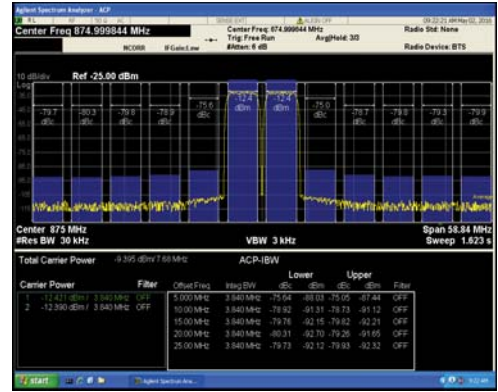

Figure 27. Two-Carrier W-CDMA at 875 MHz

AC (Mix-Mode)

$I_{OUTFS} = 40\text{ mA}$ ,  $f_{DAC} = 5.0\text{ GSPS}$ , nominal supplies,  $T_A = 25^\circ\text{C}$ , unless otherwise noted.

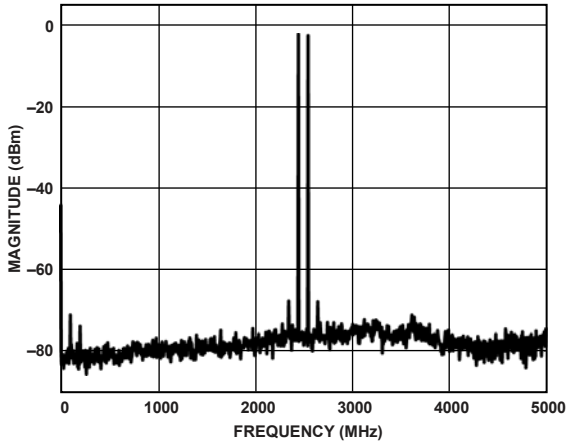

Figure 28. Single-Tone Spectrum at  $f_{OUT} = 2550\text{ MHz}$

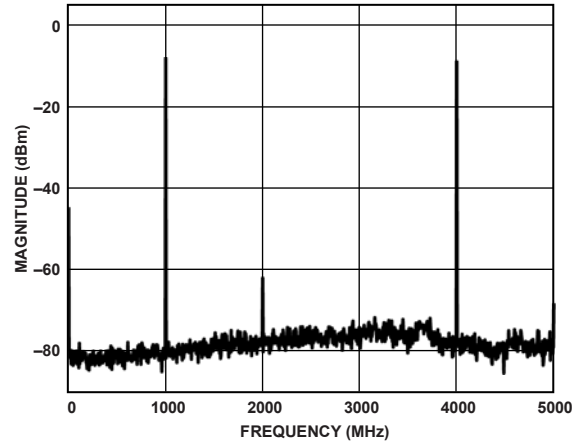

Figure 31. Single-Tone Spectrum at  $f_{OUT} = 4000\text{ MHz}$

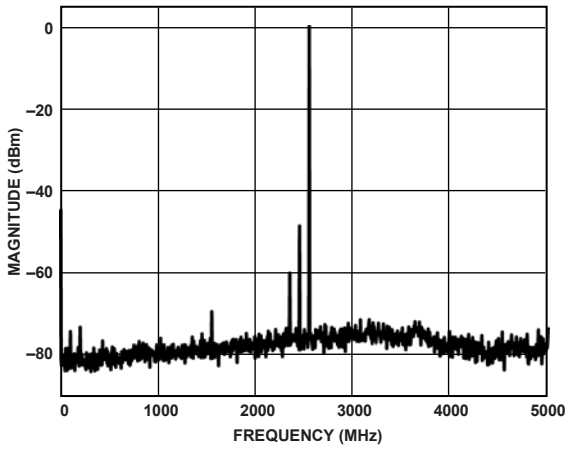

Figure 29. Single-Tone Spectrum at  $f_{OUT} = 2550\text{ MHz}$  (FIR85 Enabled)

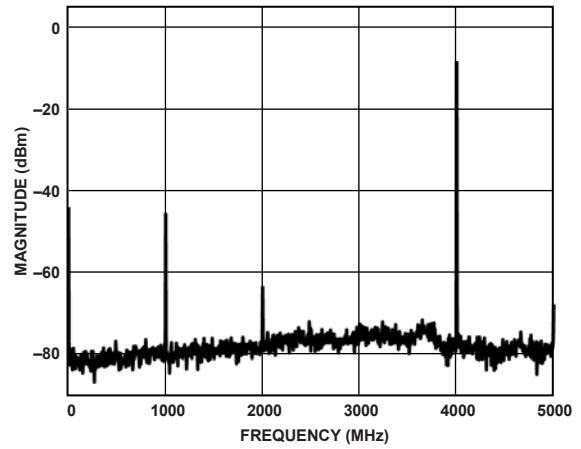

Figure 32. Single-Tone Spectrum at  $f_{OUT} = 4000\text{ MHz}$  (FIR85 Enabled)

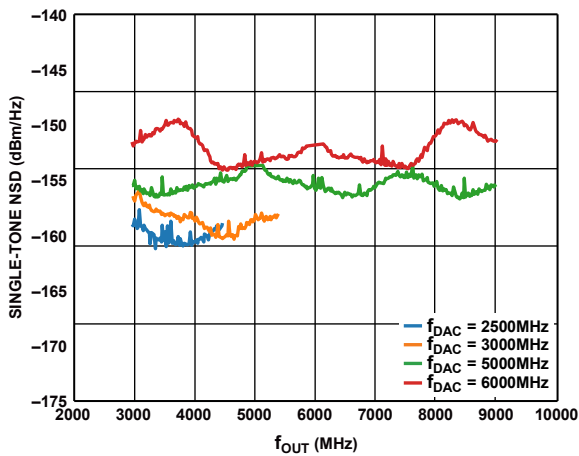

Figure 30. Single-Tone NSD Measured at  $70\text{ MHz}$  vs.  $f_{OUT}$

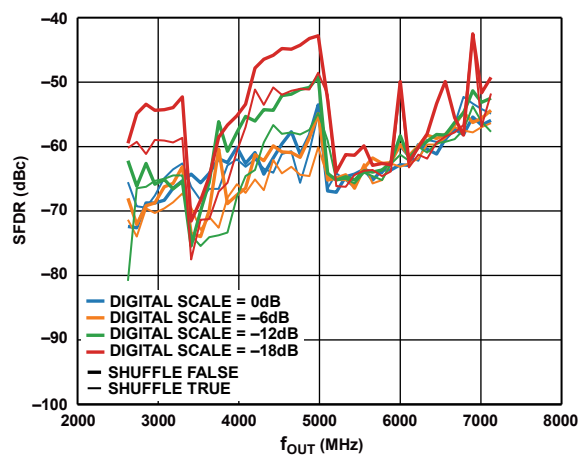

Figure 33. SFDR vs.  $f_{OUT}$  over Digital Full Scale

$I_{OUTFS} = 40 \text{ mA}$ ,  $f_{DAC} = 5.0 \text{ GSPS}$ , nominal supplies,  $T_A = 25^\circ\text{C}$ , unless otherwise noted.

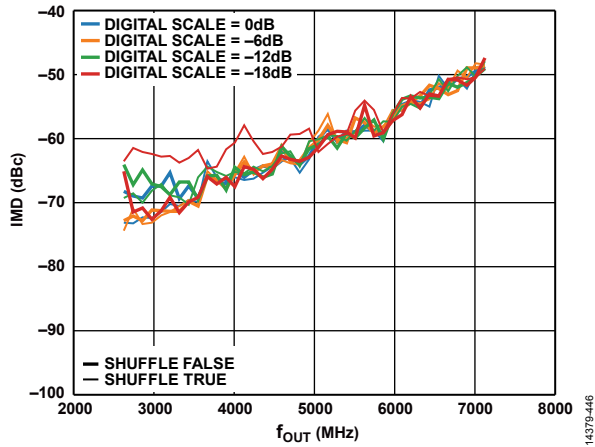

Figure 34. IMD vs.  $f_{OUT}$  over Digital Full Scale

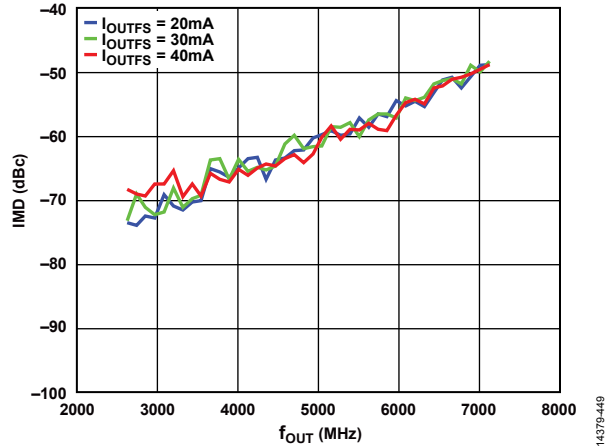

Figure 37. IMD vs.  $f_{OUT}$  over DAC  $I_{OUTFS}$

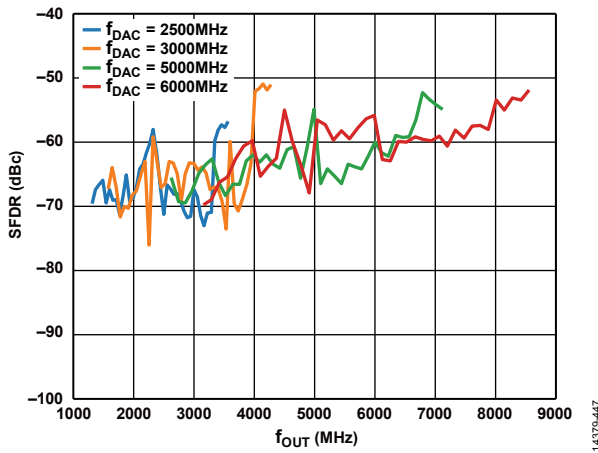

Figure 35. SFDR vs.  $f_{OUT}$  over  $f_{DAC}$

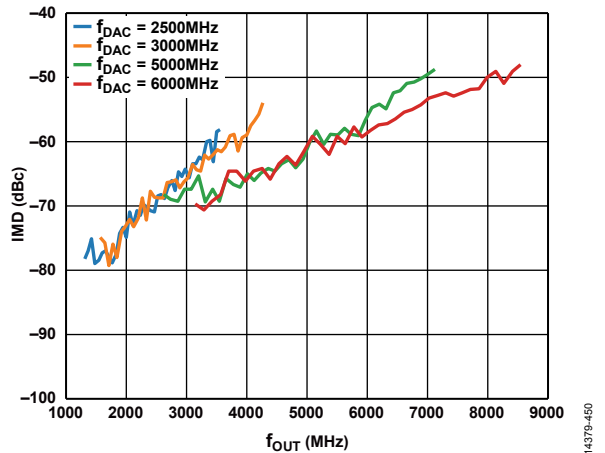

Figure 38. IMD vs.  $f_{OUT}$  over  $f_{DAC}$

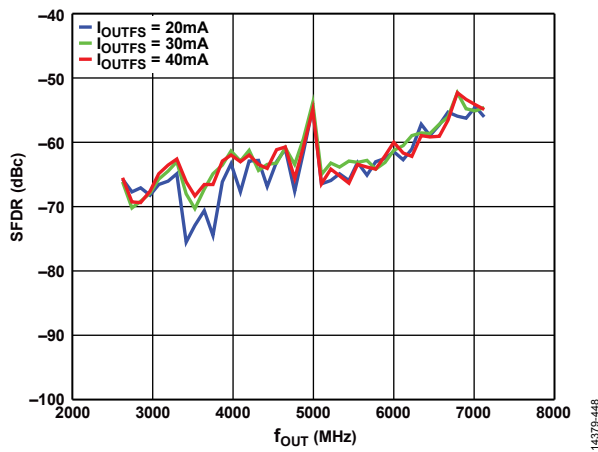

Figure 36. SFDR vs.  $f_{OUT}$  over DAC  $I_{OUTFS}$

**DOCSIS Performance (NRZ Mode)**

$I_{OUTFS} = 40 \text{ mA}$ ,  $f_{DAC} = 3.076 \text{ GSPS}$ , nominal supplies, FIR85 enabled,  $T_A = 25^\circ\text{C}$ , unless otherwise noted.

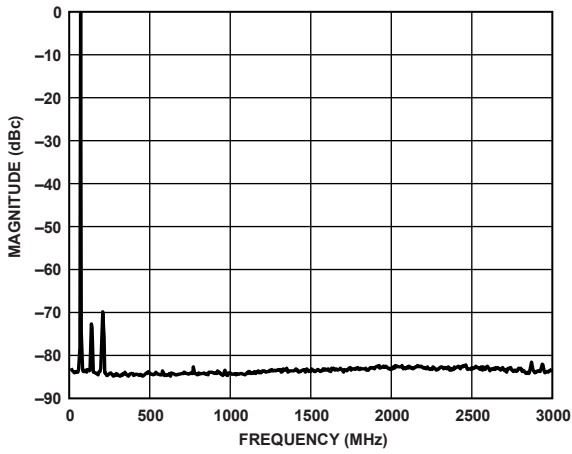

Figure 39. Single Carrier at 70 MHz Output

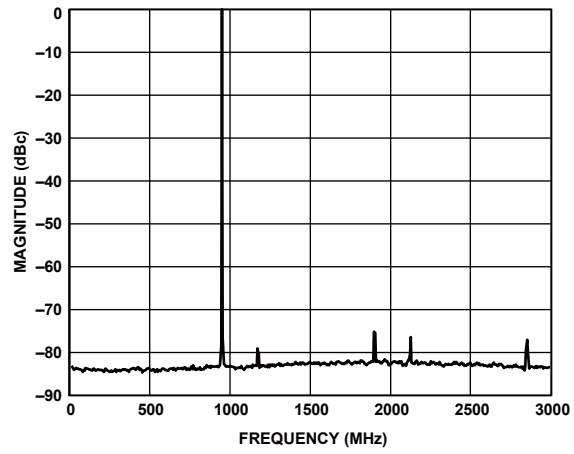

Figure 42. Single Carrier at 950 MHz Output

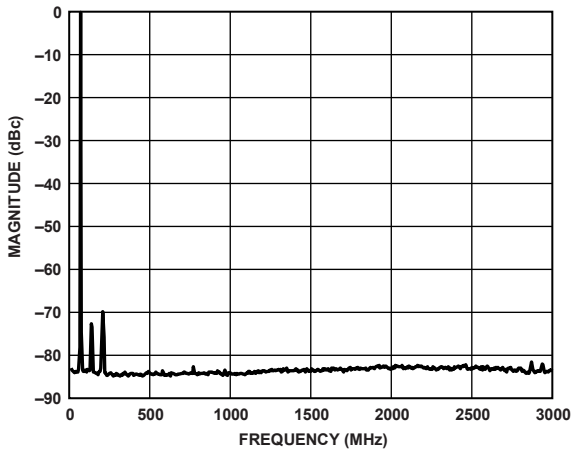

Figure 40. Four Carriers at 70 MHz Output

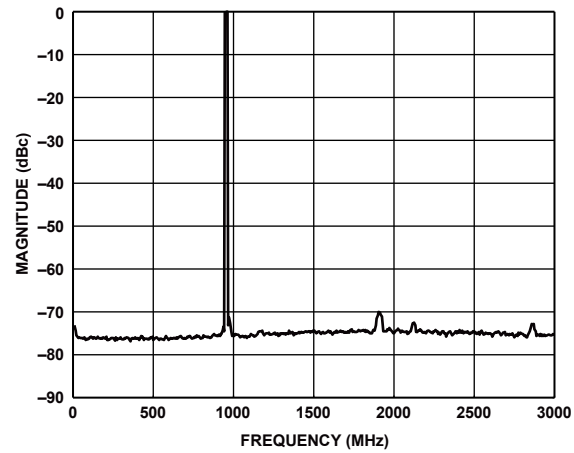

Figure 43. Four Carriers at 950 MHz Output

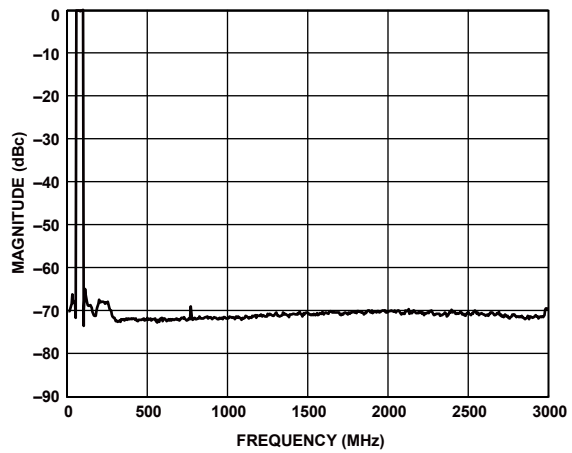

Figure 41. Eight Carriers at 70 MHz Output

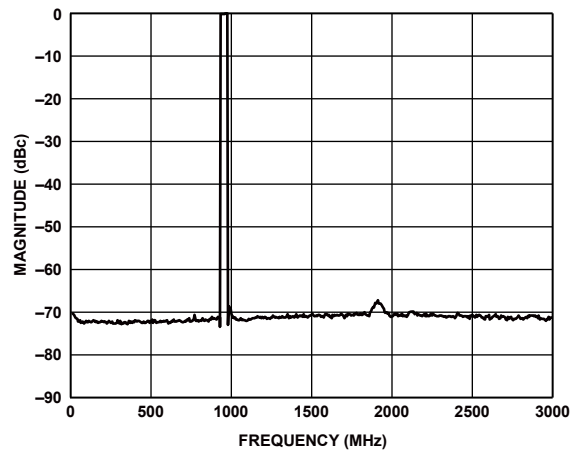

Figure 44. Eight Carriers at 950 MHz Output



$I_{OUTFS} = 40 \text{ mA}$ ,  $f_{DAC} = 3.076 \text{ GSPS}$ , nominal supplies, FIR85 enabled,  $T_A = 25^\circ\text{C}$ , unless otherwise noted.

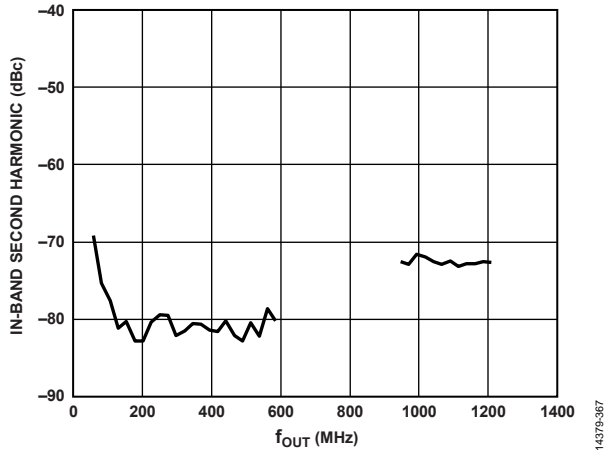

Figure 45. In-Band Second Harmonic vs.  $f_{OUT}$  Performance for One DOCSIS Carrier

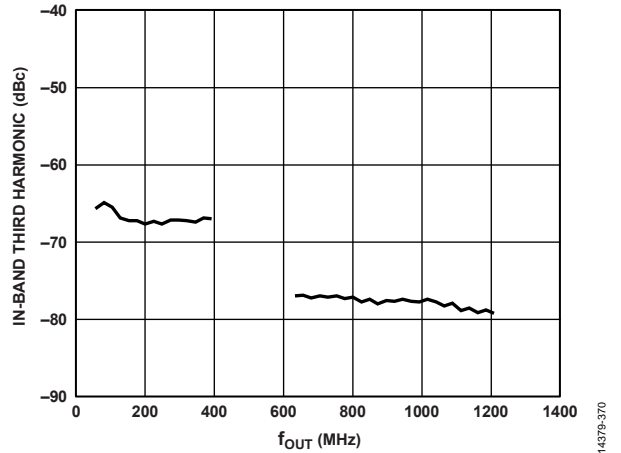

Figure 48. In-Band Third Harmonic vs.  $f_{OUT}$  Performance for One DOCSIS Carrier

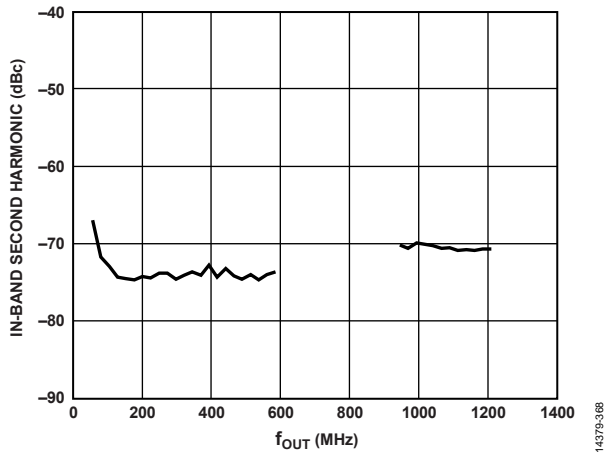

Figure 46. In-Band Second Harmonic vs.  $f_{OUT}$  Performance for Four DOCSIS Carriers

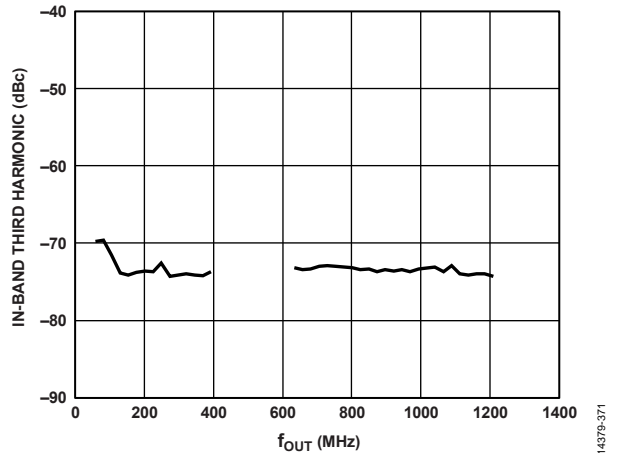

Figure 49. In-Band Third Harmonic vs.  $f_{OUT}$  Performance for Four DOCSIS Carriers

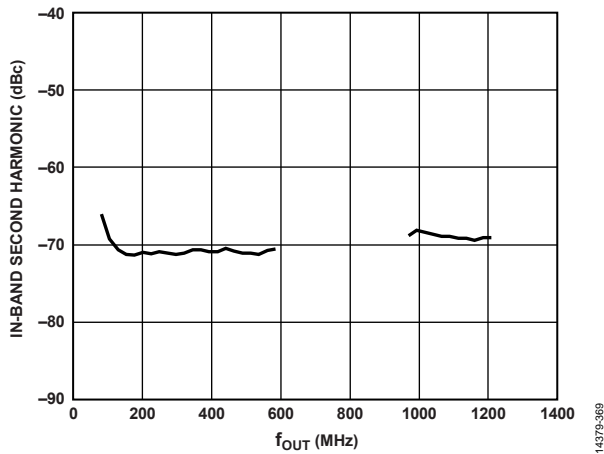

Figure 47. In-Band Second Harmonic vs.  $f_{OUT}$  Performance for Eight DOCSIS Carriers

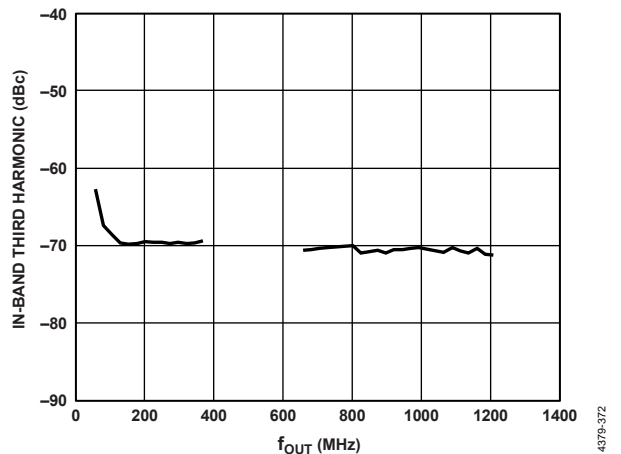

Figure 50. In-Band Third Harmonic vs.  $f_{OUT}$  Performance for Eight DOCSIS Carriers

$I_{OUTFS} = 40 \text{ mA}$ ,  $f_{DAC} = 3.076 \text{ GSPS}$ , nominal supplies, FIR85 enabled,  $T_A = 25^\circ\text{C}$ , unless otherwise noted.

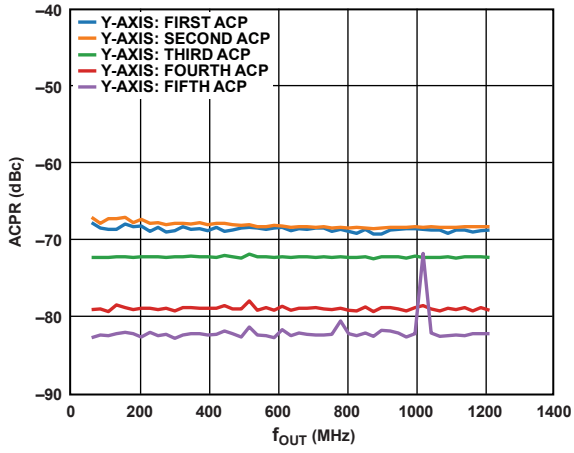

Figure 51. Single-Carrier Adjacent Channel Power Ratio (ACPR) vs.  $f_{OUT}$

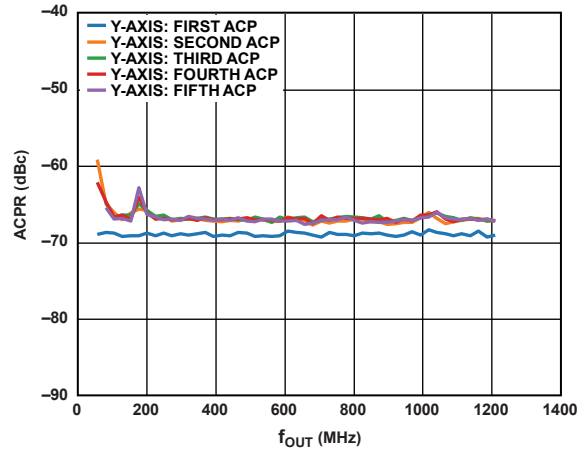

Figure 54. 16-Carrier ACPR vs.  $f_{OUT}$

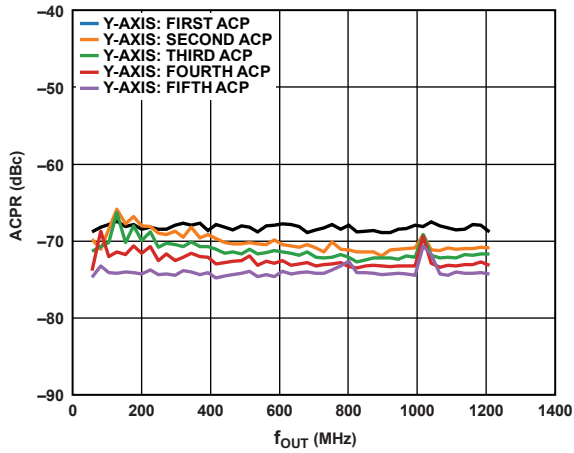

Figure 52. Four-Carrier ACPR vs.  $f_{OUT}$

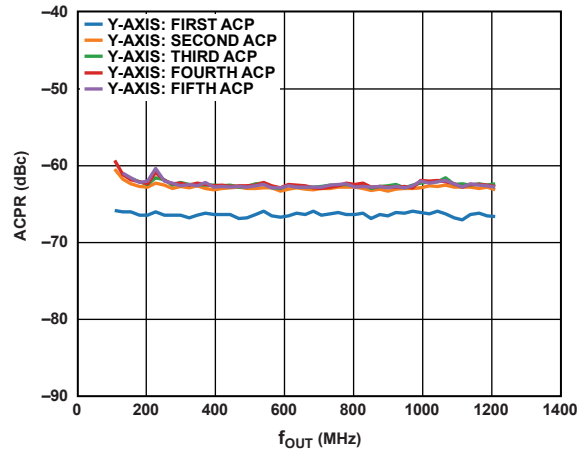

Figure 55. 32-Carrier ACPR vs.  $f_{OUT}$

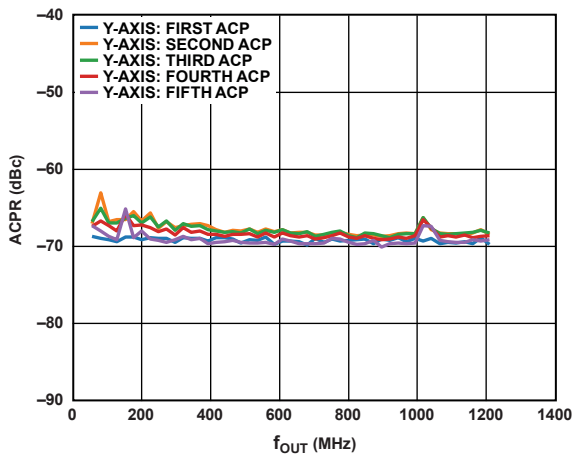

Figure 53. Eight-Carrier ACPR vs.  $f_{OUT}$

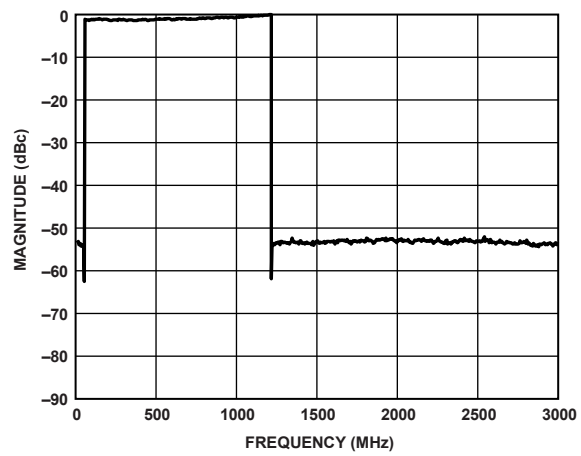

Figure 56. 194-Carrier, Sinc On, FIR85 Enabled

$I_{OUTFS} = 40 \text{ mA}$ ,  $f_{DAC} = 3.076 \text{ GSPS}$ , nominal supplies, FIR85 enabled,  $T_A = 25^\circ\text{C}$ , unless otherwise noted.

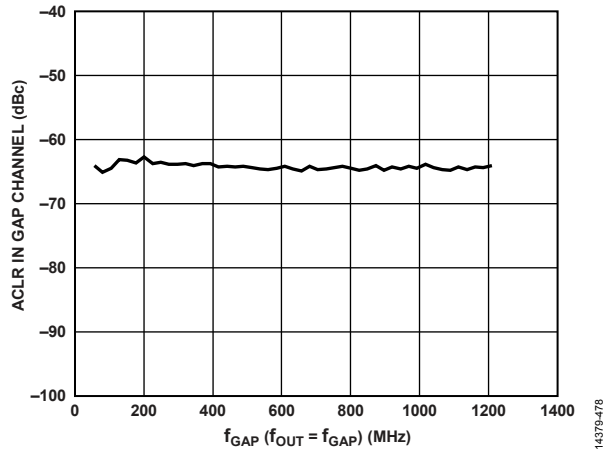

Figure 57. ACLR in Gap Channel vs.  $f_{GAP}$

## AD9162

### Static Linearity

$I_{OUTFS} = 40\text{ mA}$ , nominal supplies,  $T_A = 25^\circ\text{C}$ , unless otherwise noted.

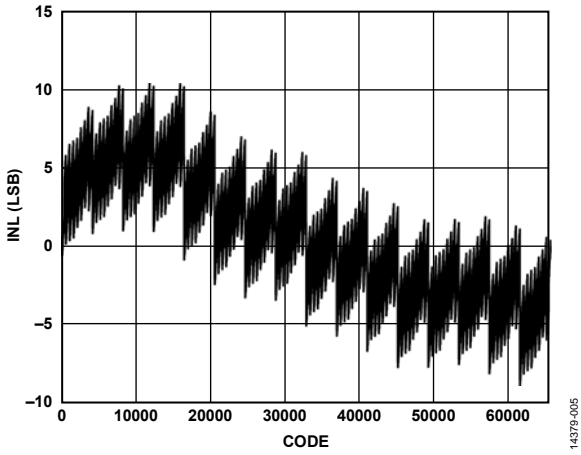

Figure 58. INL,  $I_{OUTFS} = 20\text{ mA}$

14379-005

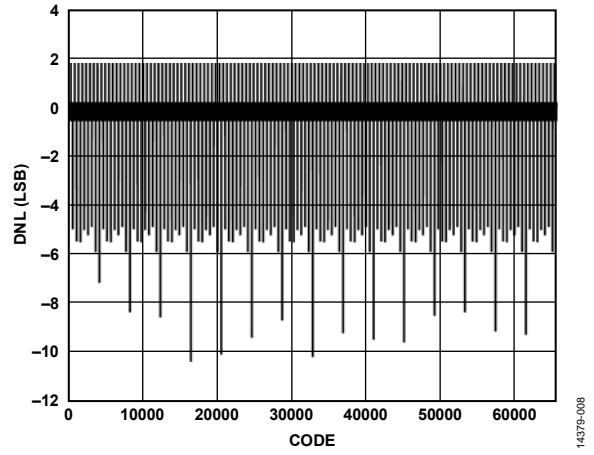

Figure 61. DNL,  $I_{OUTFS} = 20\text{ mA}$

14379-008

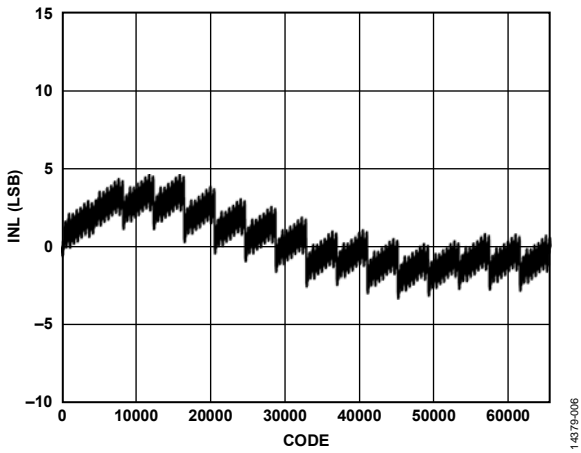

Figure 59. INL,  $I_{OUTFS} = 30\text{ mA}$

14379-006

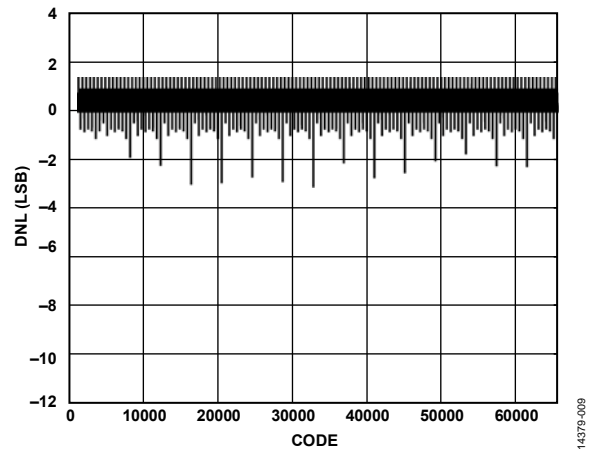

Figure 62. DNL,  $I_{OUTFS} = 30\text{ mA}$

14379-009

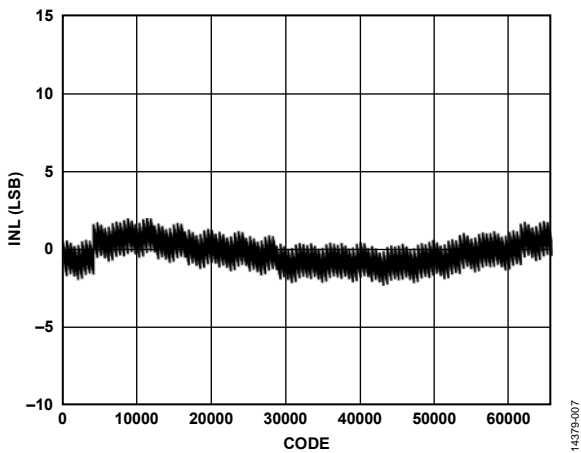

Figure 60. INL,  $I_{OUTFS} = 40\text{ mA}$

14379-007

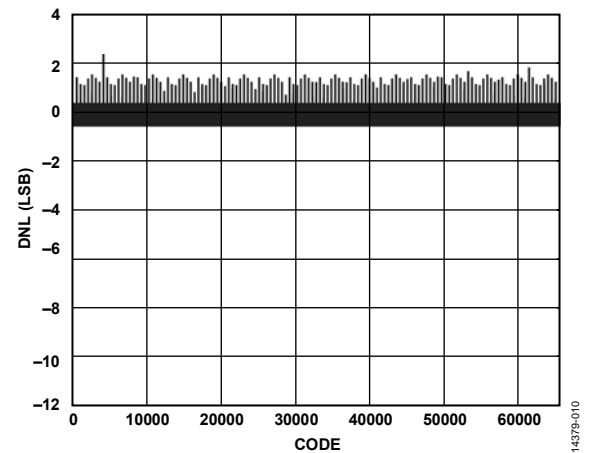

Figure 63. DNL,  $I_{OUTFS} = 40\text{ mA}$

14379-010

**AC Performance (NRZ Mode)**

$I_{OUTFS} = 40 \text{ mA}$ ,  $f_{DAC} = 5.0 \text{ GSPS}$ , nominal supplies,  $T_A = 25^\circ\text{C}$ , unless otherwise noted.

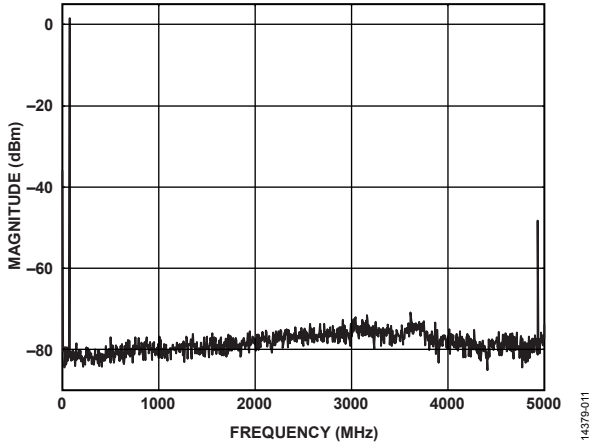

Figure 64. Single-Tone Spectrum at  $f_{OUT} = 70 \text{ MHz}$

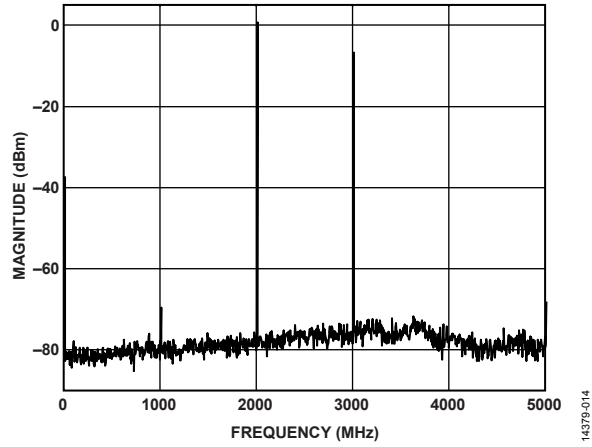

Figure 67. Single-Tone Spectrum at  $f_{OUT} = 2000 \text{ MHz}$

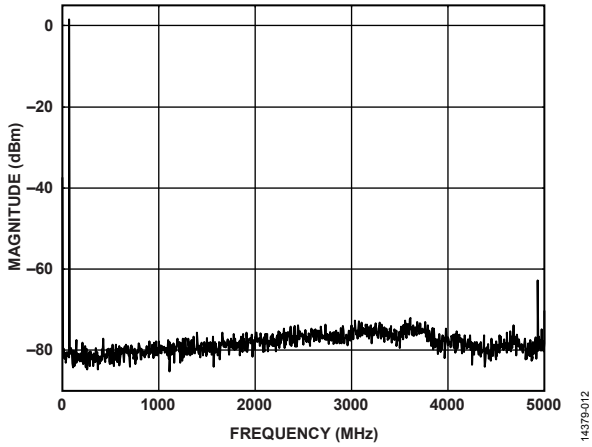

Figure 65. Single-Tone Spectrum at  $f_{OUT} = 70 \text{ MHz}$  (FIR85 Enabled)

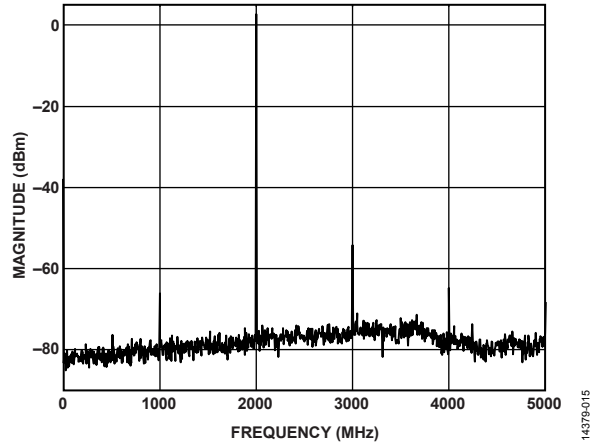

Figure 68. Single-Tone Spectrum at  $f_{OUT} = 2000 \text{ MHz}$  (FIR85 Enabled)

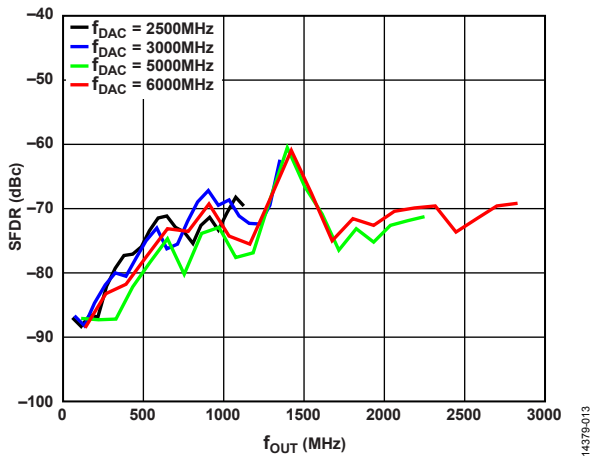

Figure 66. SFDR vs.  $f_{OUT}$  over  $f_{DAC}$

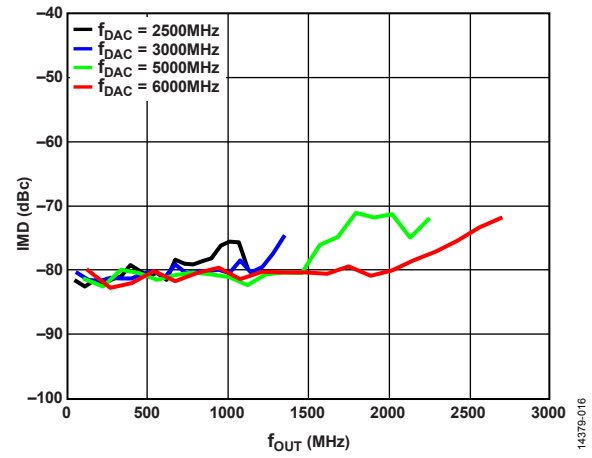

Figure 69. IMD vs.  $f_{OUT}$  over  $f_{DAC}$

$I_{OUTFS} = 40 \text{ mA}$ ,  $f_{DAC} = 5.0 \text{ GSPS}$ , nominal supplies,  $T_A = 25^\circ\text{C}$ , unless otherwise noted.

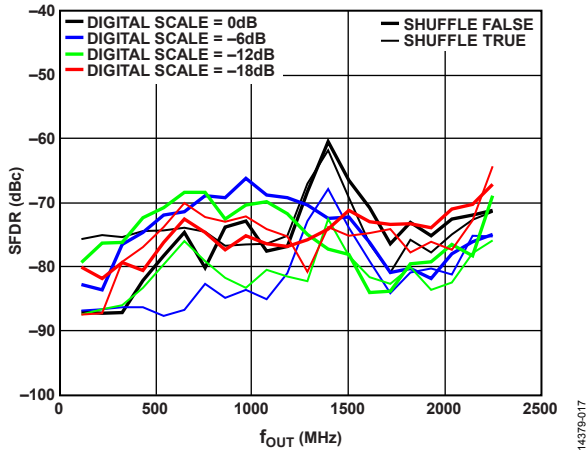

Figure 70. SFDR vs.  $f_{OUT}$  over Digital Scale

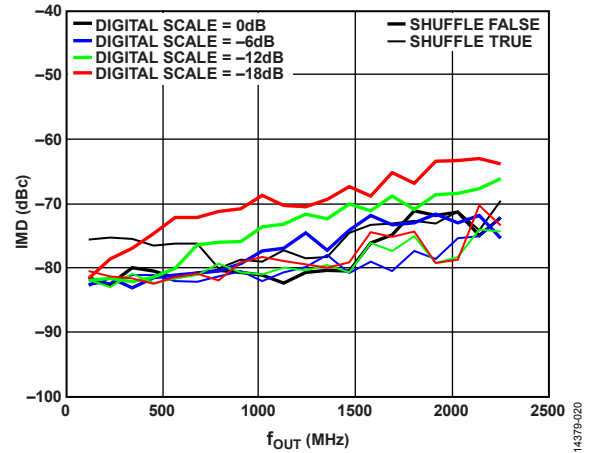

Figure 73. IMD vs.  $f_{OUT}$  over Digital Scale

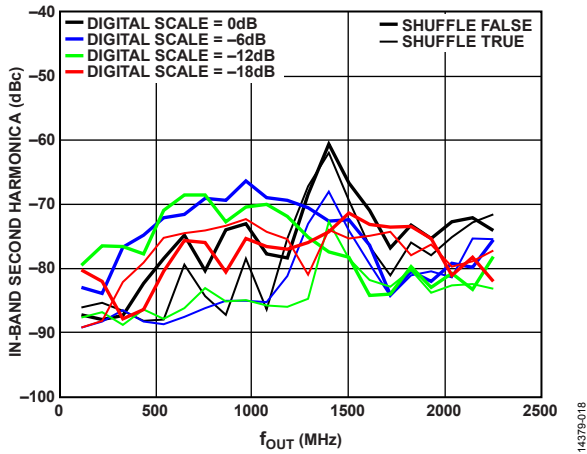

Figure 71. SFDR for In-Band Second Harmonic vs.  $f_{OUT}$  over Digital Scale

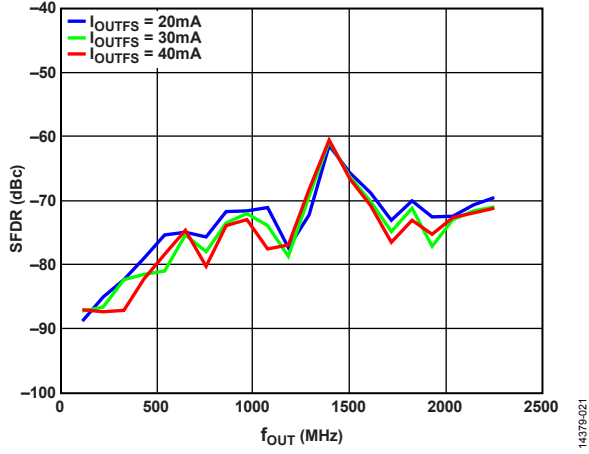

Figure 74. SFDR vs.  $f_{OUT}$  over DAC  $I_{OUTFS}$

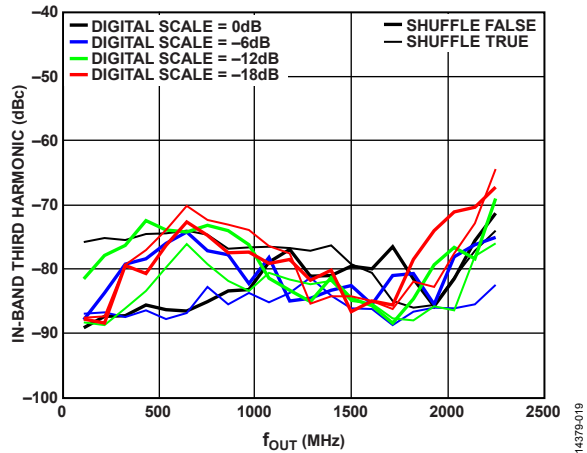

Figure 72. SFDR for In-Band Third Harmonic vs.  $f_{OUT}$  over Digital Scale

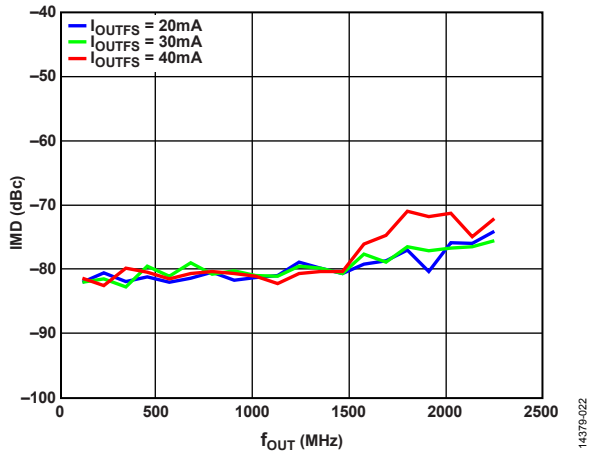

Figure 75. IMD vs.  $f_{OUT}$  over DAC  $I_{OUTFS}$

$I_{OUTFS} = 40 \text{ mA}$ ,  $f_{DAC} = 5.0 \text{ GSPS}$ , nominal supplies,  $T_A = 25^\circ\text{C}$ , unless otherwise noted.

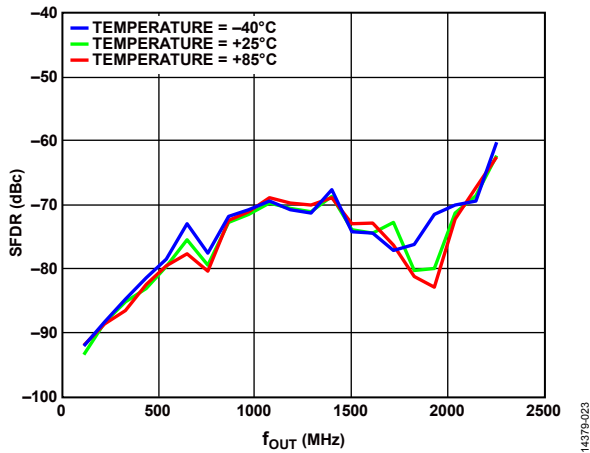

Figure 76. SFDR vs.  $f_{OUT}$  over Temperature

14379-023

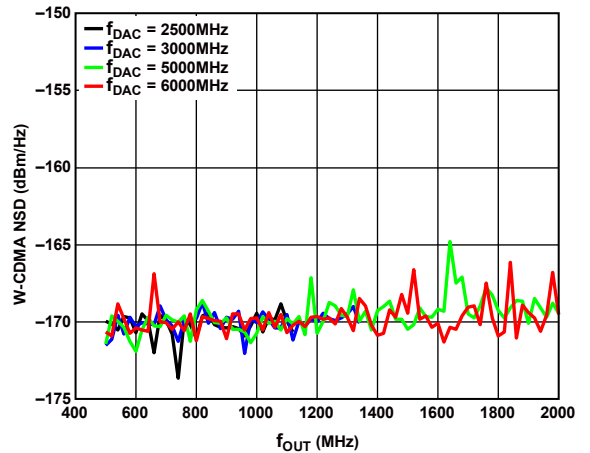

Figure 79. W-CDMA NSD Measured at 70 MHz vs.  $f_{OUT}$  over  $f_{DAC}$

14379-025

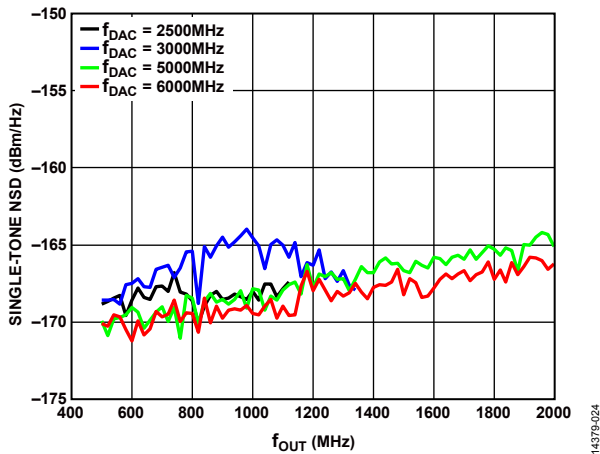

Figure 77. Single-Tone NSD Measured at 70 MHz vs.  $f_{OUT}$  over  $f_{DAC}$

14379-024

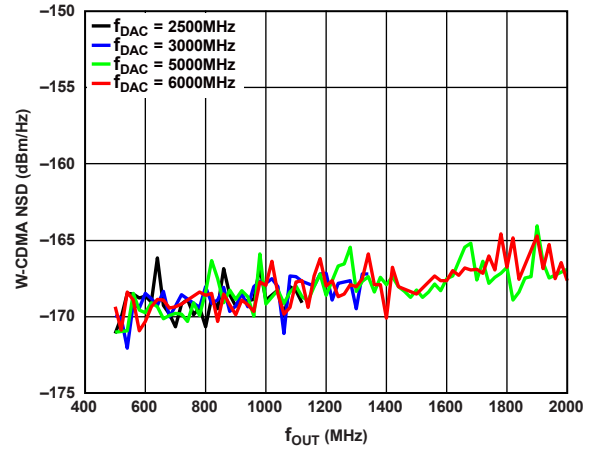

Figure 80. W-CDMA NSD Measured at 10% Offset from  $f_{OUT}$  vs.  $f_{OUT}$  over  $f_{DAC}$

14379-225

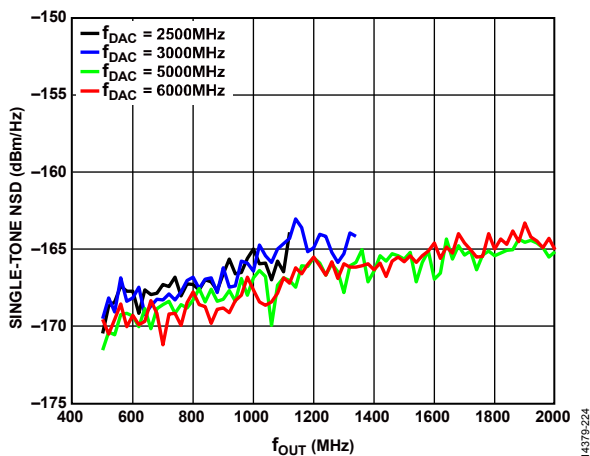

Figure 78. Single-Tone NSD Measured at 10% Offset from  $f_{OUT}$  vs.  $f_{OUT}$  over  $f_{DAC}$

14379-224

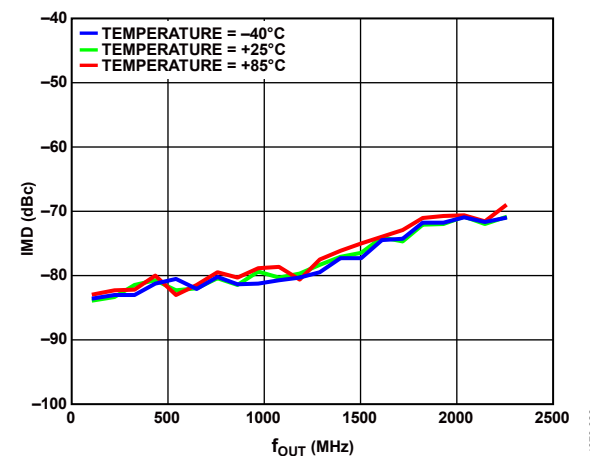

Figure 81. IMD vs.  $f_{OUT}$  over Temperature

14379-026

$I_{OUTFS} = 40 \text{ mA}$ ,  $f_{DAC} = 5.0 \text{ GSPS}$ , nominal supplies,  $T_A = 25^\circ\text{C}$ , unless otherwise noted.

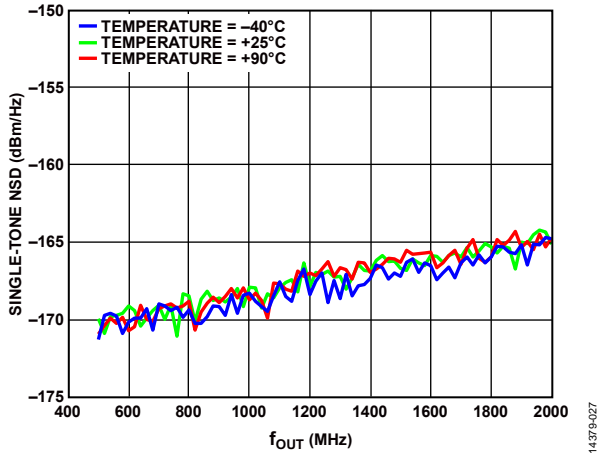

Figure 82. Single-Tone NSD Measured at 70 MHz vs.  $f_{OUT}$  over Temperature

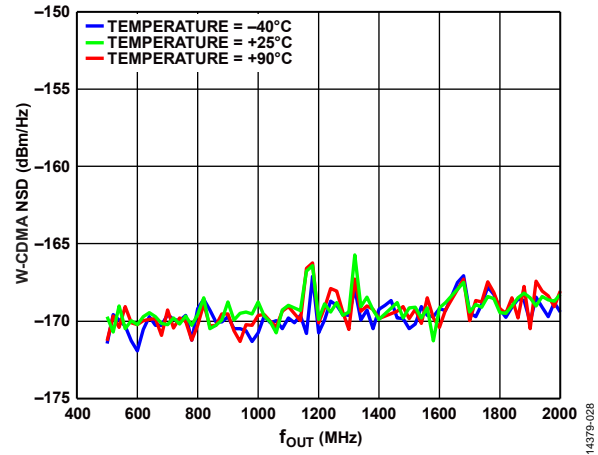

Figure 85. W-CDMA NSD Measured at 70 MHz vs.  $f_{OUT}$  over Temperature

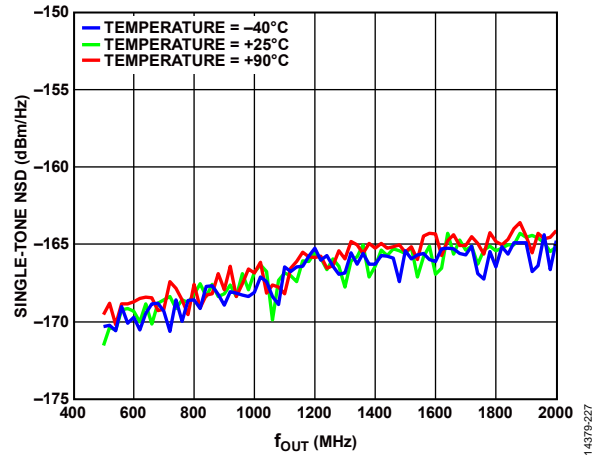

Figure 83. Single-Tone NSD Measured at 10% Offset from  $f_{OUT}$  vs.  $f_{OUT}$  over Temperature

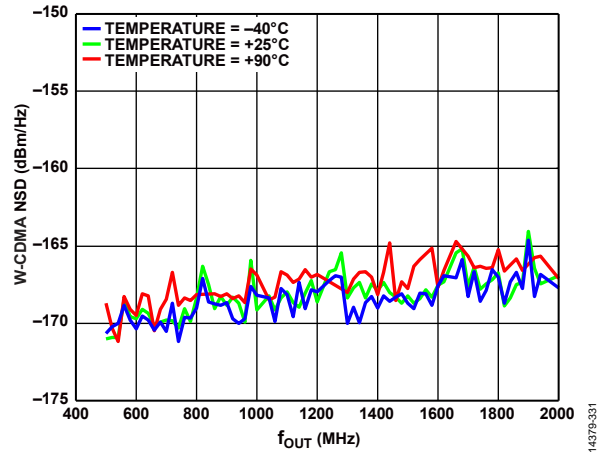

Figure 86. W-CDMA NSD Measured at 10% Offset from  $f_{OUT}$  vs.  $f_{OUT}$  over Temperature

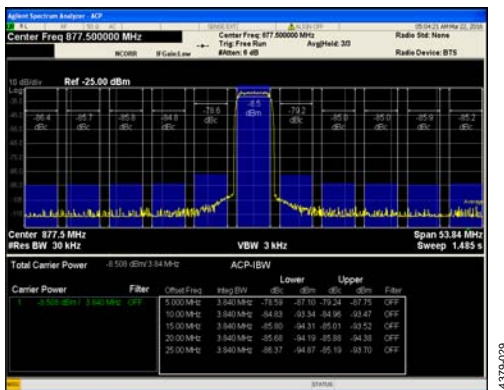

Figure 84. Single-Carrier W-CDMA at 877.5 MHz

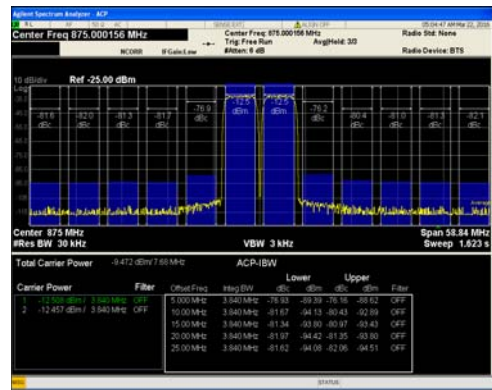

Figure 87. Two-Carrier W-CDMA at 875 MHz



$I_{OUTFS} = 40 \text{ mA}$ ,  $f_{DAC} = 5.0 \text{ GSPS}$ , nominal supplies,  $T_A = 25^\circ\text{C}$ , unless otherwise noted.

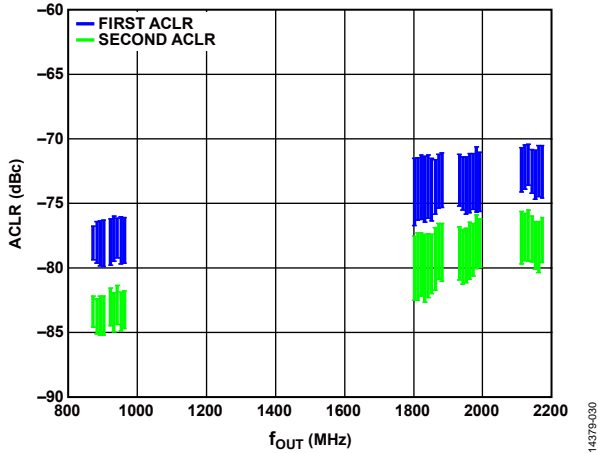

Figure 88. Single-Carrier, W-CDMA ACLR vs.  $f_{OUT}$  (First ACLR, Second ACLR)

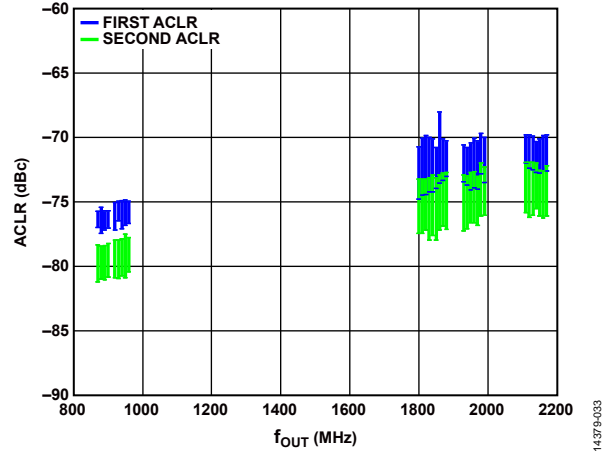

Figure 91. Two-Carrier, W-CDMA ACLR vs.  $f_{OUT}$  (First ACLR, Second ACLR)

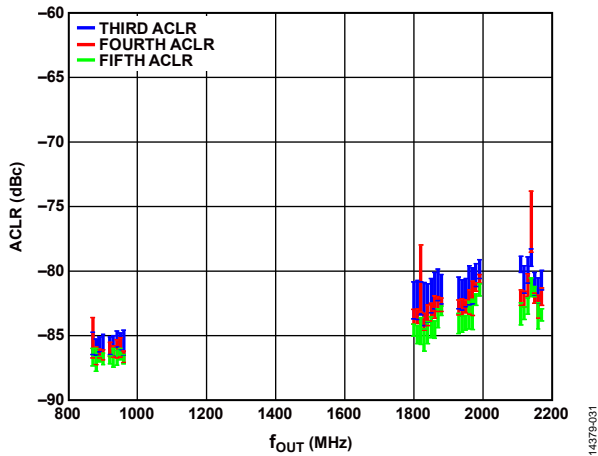

Figure 89. Single-Carrier, W-CDMA ACLR vs.  $f_{OUT}$  (Third ACLR, Fourth ACLR, Fifth ACLR)

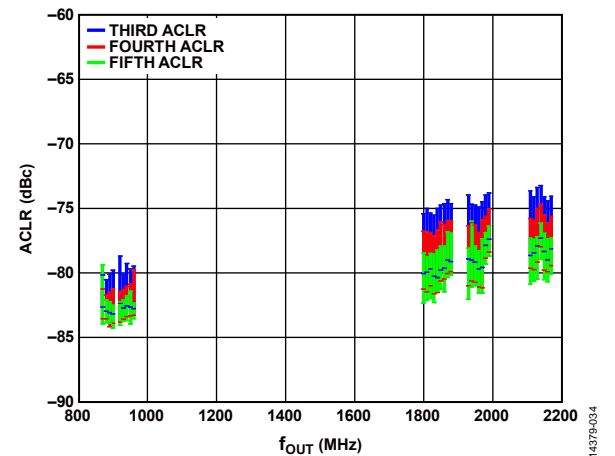

Figure 92. Two-Carrier, W-CDMA ACLR vs.  $f_{OUT}$  (Third ACLR, Fourth ACLR, Fifth ACLR)

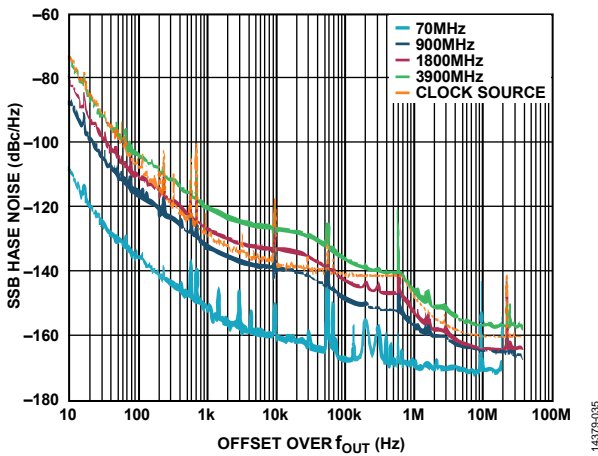

Figure 90. SSB Phase Noise vs. Offset over  $f_{OUT}$ ,  $f_{DAC} = 4000 \text{ MSPS}$  (Two Different DAC Clock Sources Used for Best Composite Curve)

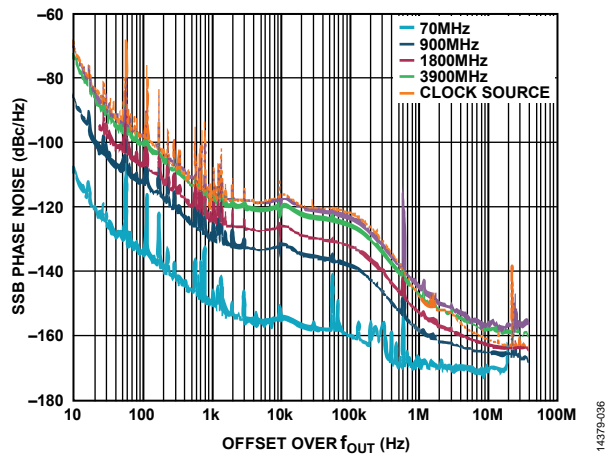

Figure 93. SSB Phase Noise vs. Offset over  $f_{OUT}$ ,  $f_{DAC} = 6000 \text{ MSPS}$

AC (Mix-Mode)

$I_{OUTFS} = 40\text{ mA}$ ,  $f_{DAC} = 5.0\text{ GSPS}$ , nominal supplies,  $T_A = 25^\circ\text{C}$ , unless otherwise noted.

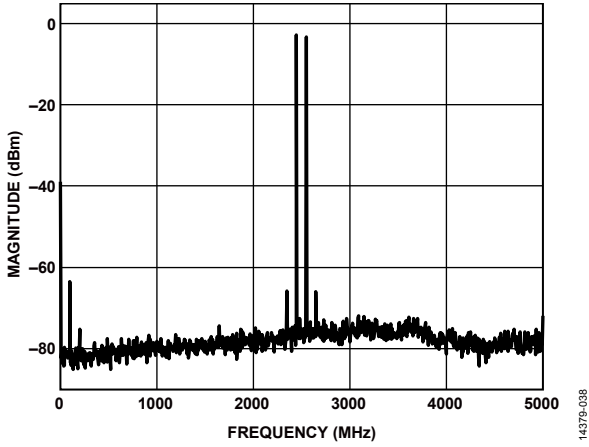

Figure 94. Single-Tone Spectrum at  $f_{OUT} = 2350\text{ MHz}$

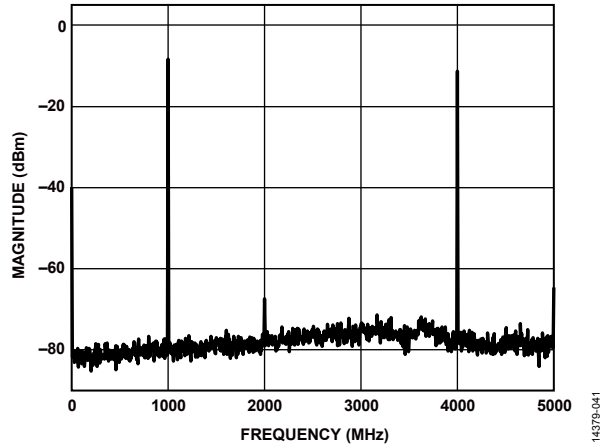

Figure 97. Single-Tone Spectrum at  $f_{OUT} = 4000\text{ MHz}$

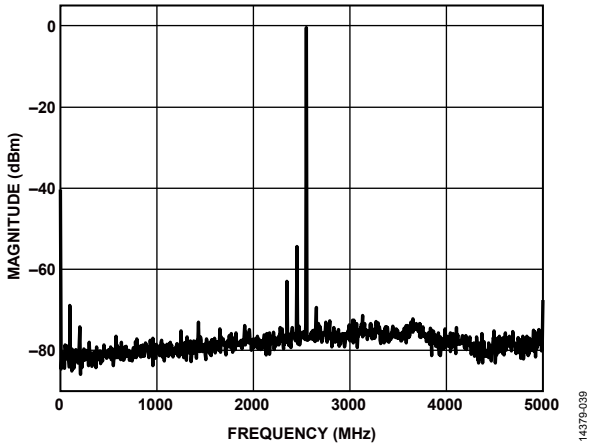

Figure 95. Single-Tone Spectrum at  $f_{OUT} = 2350\text{ MHz}$  (FIR85 Enabled)

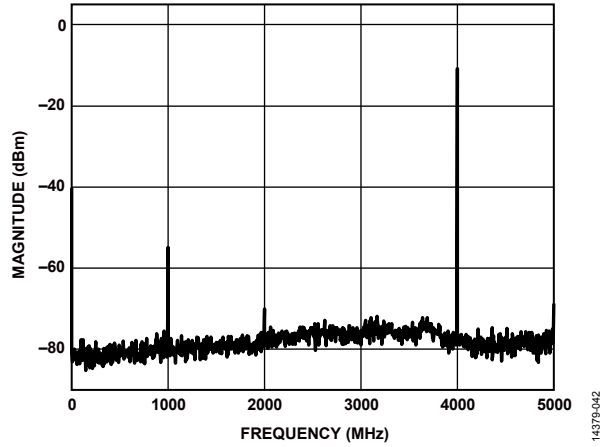

Figure 98. Single-Tone Spectrum at  $f_{OUT} = 4000\text{ MHz}$  (FIR85 Enabled)

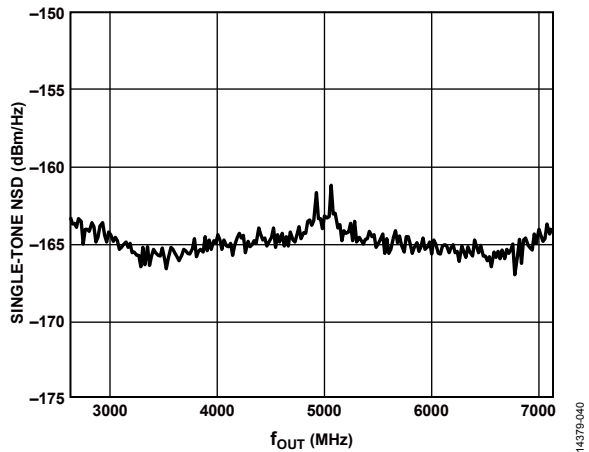

Figure 96. Single-Tone NSD vs.  $f_{OUT}$

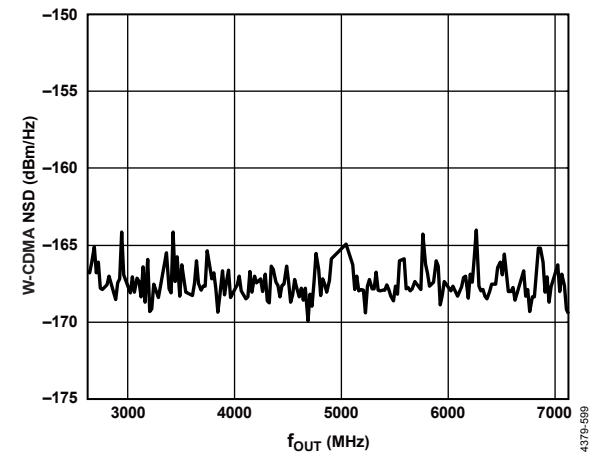

Figure 99. W-CDMA NSD vs.  $f_{OUT}$

$I_{OUTFS} = 40 \text{ mA}$ ,  $f_{DAC} = 5.0 \text{ GSPS}$ , nominal supplies,  $T_A = 25^\circ\text{C}$ , unless otherwise noted.

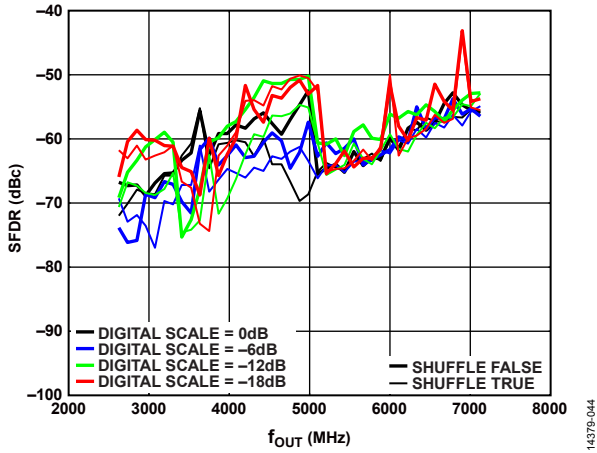

Figure 100. SFDR vs.  $f_{OUT}$  over Digital Scale

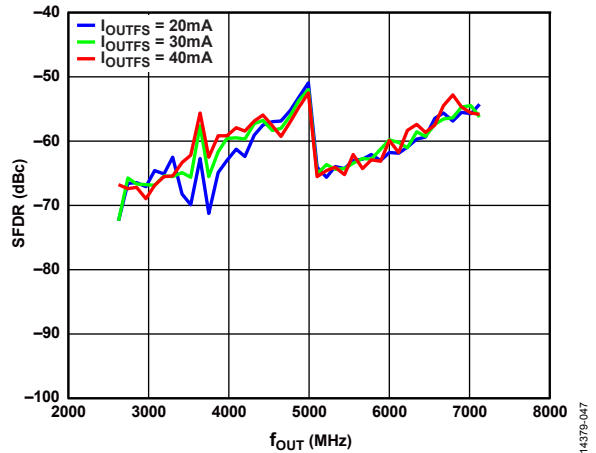

Figure 103. SFDR vs.  $f_{OUT}$  over DAC  $I_{OUTFS}$

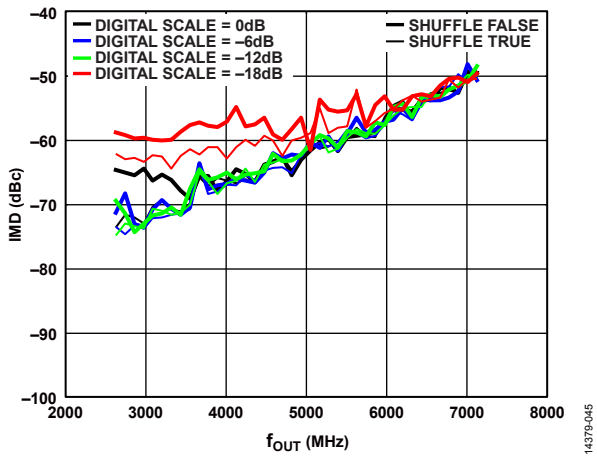

Figure 101. IMD vs.  $f_{OUT}$  over Digital Scale

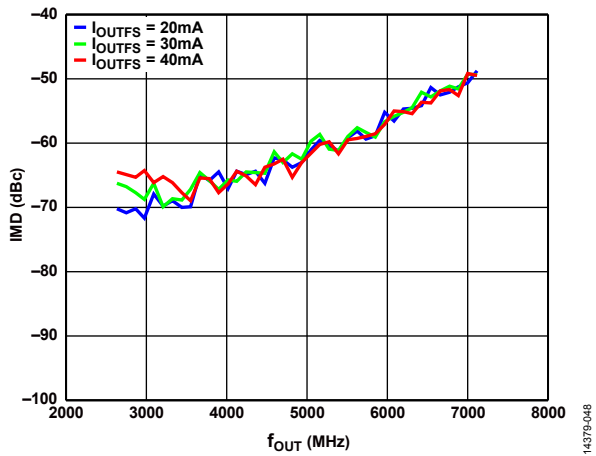

Figure 104. IMD vs.  $f_{OUT}$  over DAC  $I_{OUTFS}$

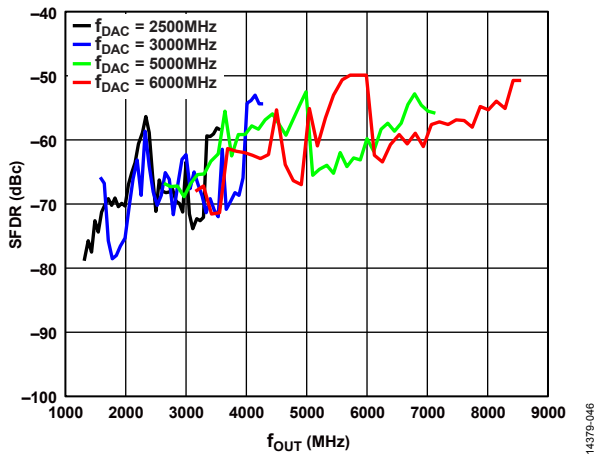

Figure 102. SFDR vs.  $f_{OUT}$  over  $f_{DAC}$

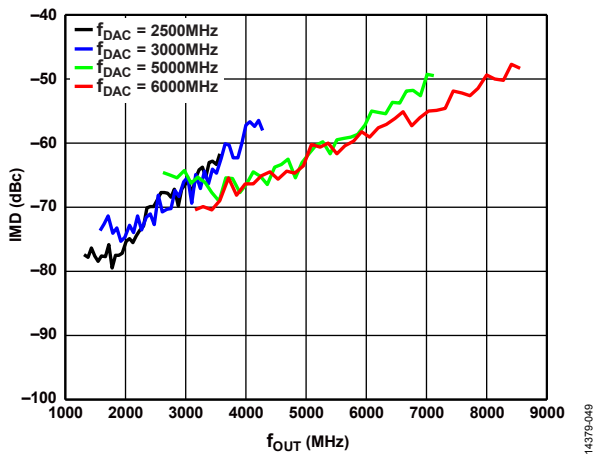

Figure 105. IMD vs.  $f_{OUT}$  over  $f_{DAC}$

$I_{OUTFS} = 40 \text{ mA}$ ,  $f_{DAC} = 5.0 \text{ GSPS}$ , nominal supplies,  $T_A = 25^\circ\text{C}$ , unless otherwise noted.

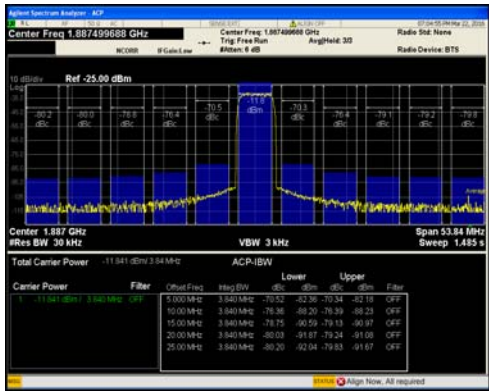

Figure 106. Single-Carrier W-CDMA at 1887.5 MHz

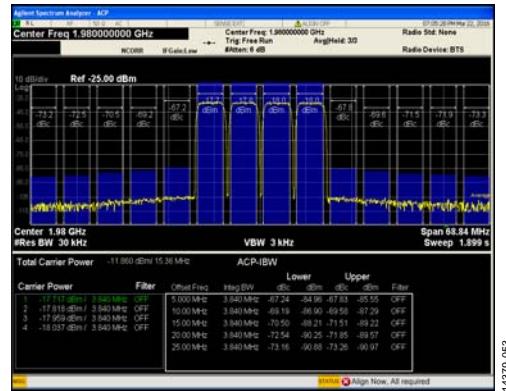

Figure 109. Four-Carrier W-CDMA at 1980 MHz

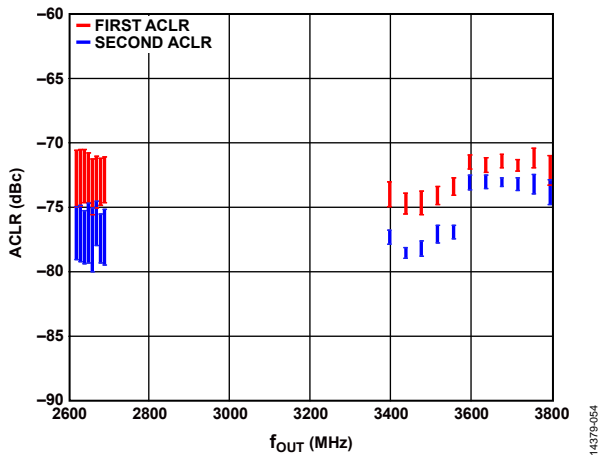

Figure 107. Single-Carrier, W-CDMA ACLR vs.  $f_{OUT}$  (First ACLR, Second ACLR)

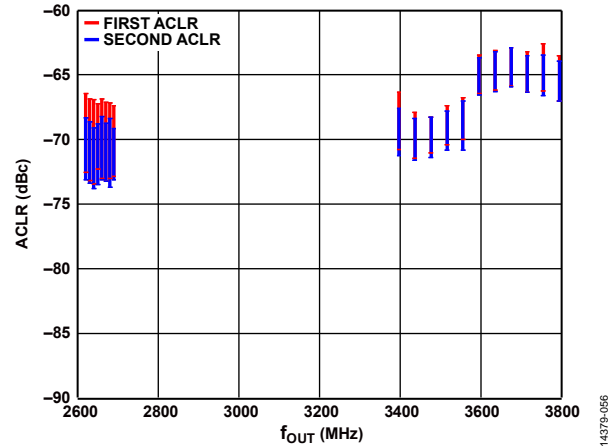

Figure 110. Four-Carrier, W-CDMA ACLR vs.  $f_{OUT}$  (First ACLR, Second ACLR)

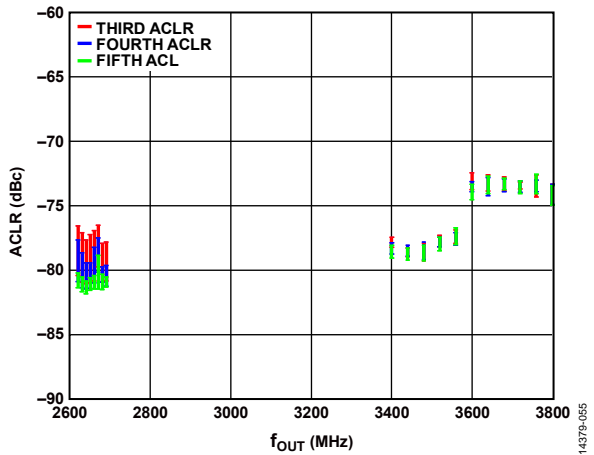

Figure 108. Single-Carrier, W-CDMA ACLR vs.  $f_{OUT}$  (Third ACLR, Fourth ACLR, Fifth ACLR)

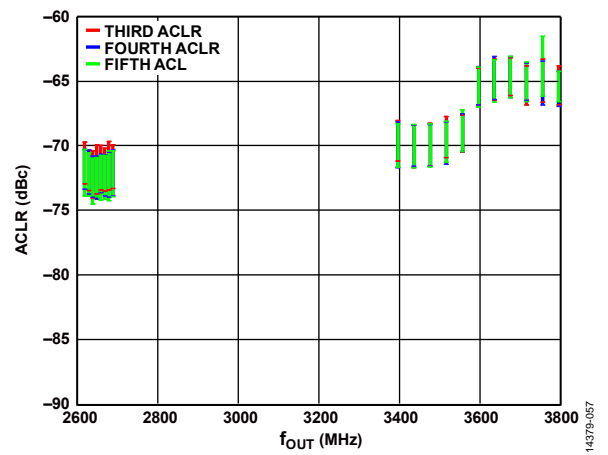

Figure 111. Four-Carrier, W-CDMA ACLR vs.  $f_{OUT}$  (Third ACLR, Fourth ACLR, Fifth ACLR)

**DOCSIS Performance (NRZ Mode)**

$I_{OUTFS} = 40 \text{ mA}$ ,  $f_{DAC} = 3.076 \text{ GSPS}$ , nominal supplies, FIR85 enabled,  $T_A = 25^\circ\text{C}$ , unless otherwise noted.

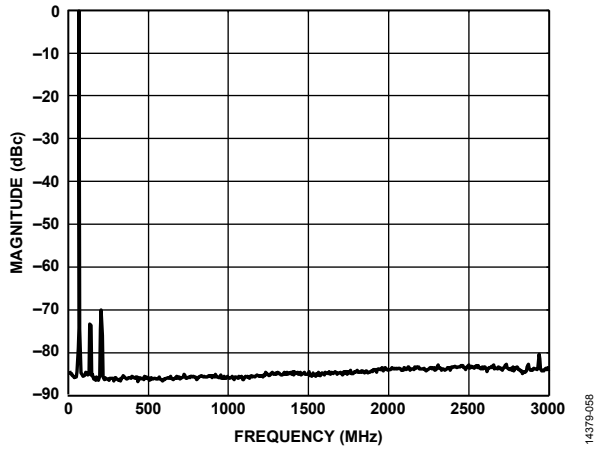

Figure 112. Single Carrier at 70 MHz Output

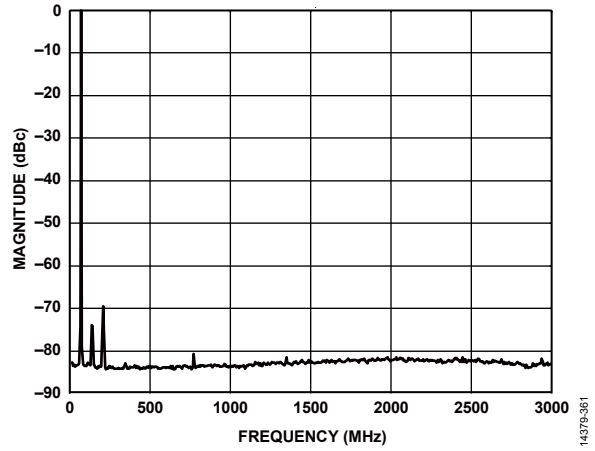

Figure 115. Single Carrier at 70 MHz Output (Shuffle On)

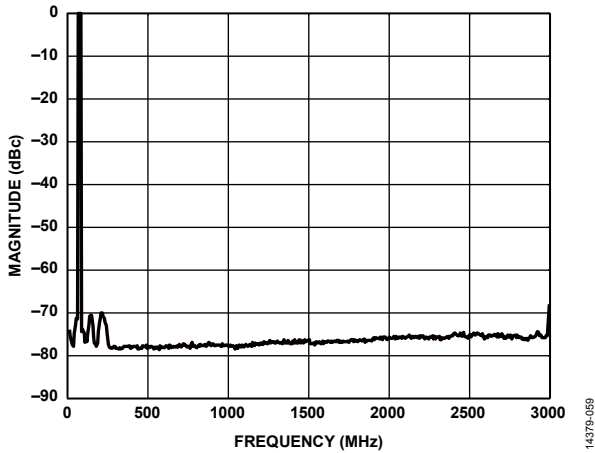

Figure 113. Four Carriers at 70 MHz Output

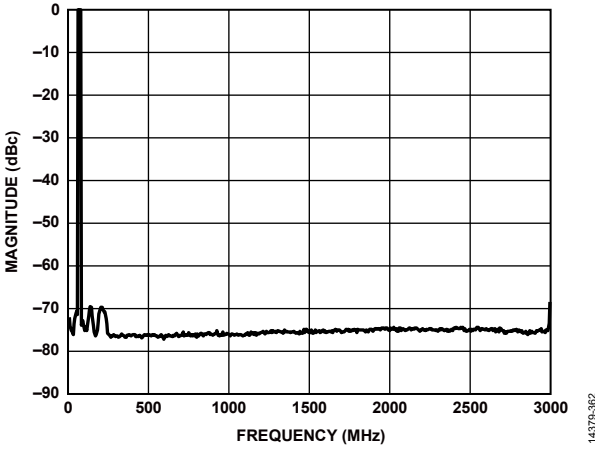

Figure 116. Four Carriers at 70 MHz Output (Shuffle On)

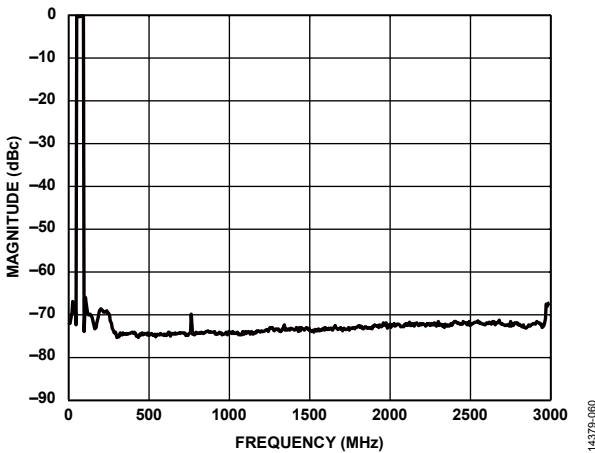

Figure 114. Eight Carriers at 70 MHz Output

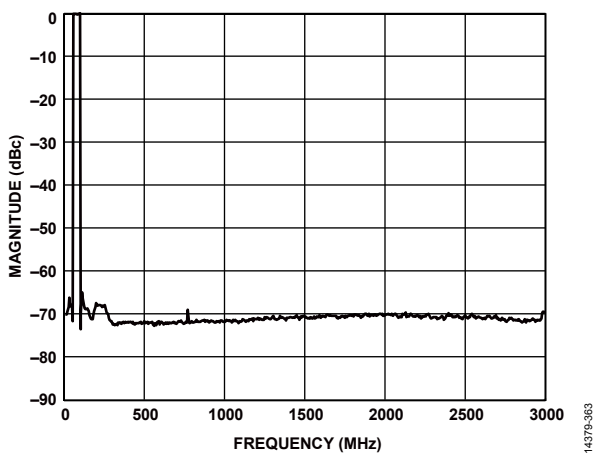

Figure 117. Eight Carriers at 70 MHz Output (Shuffle On)

$I_{OUTFS} = 40 \text{ mA}$ ,  $f_{DAC} = 3.076 \text{ GSPS}$ , nominal supplies, FIR85 enabled,  $T_A = 25^\circ\text{C}$ , unless otherwise noted.

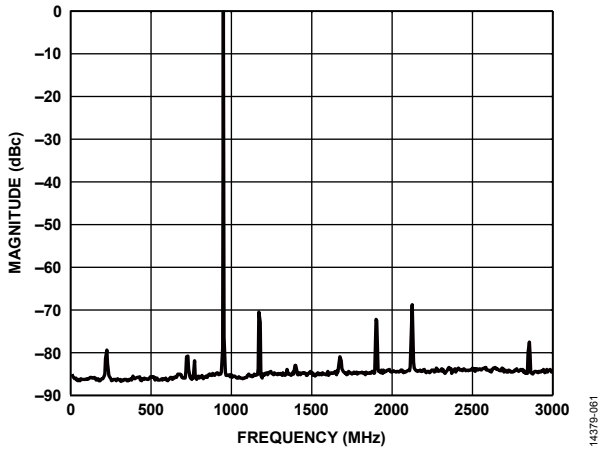

Figure 118. Single Carrier at 950 MHz Output

14379-001

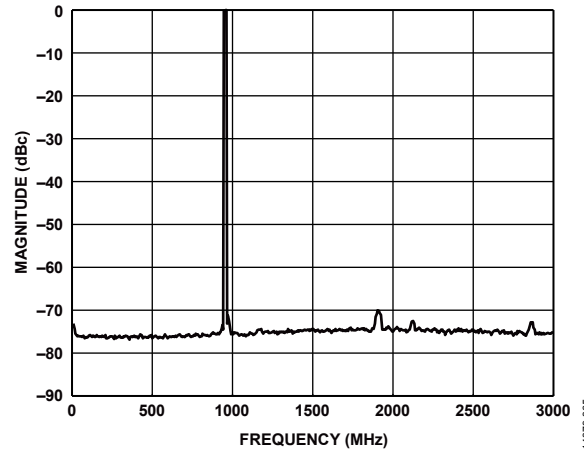

Figure 121. Four Carriers at 950 MHz Output (Shuffle On)

14379-305

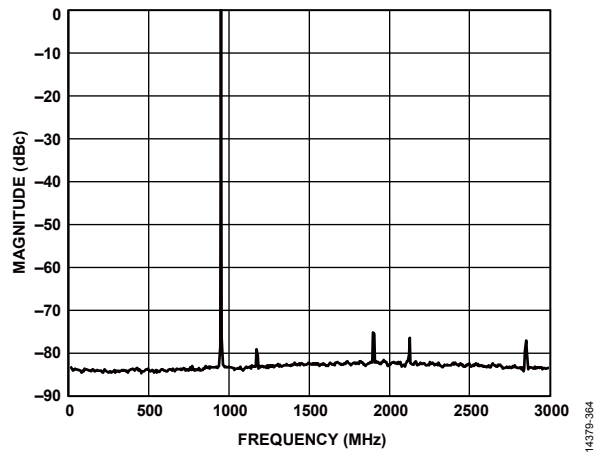

Figure 119. Single Carrier at 950 MHz Output (Shuffle On)

14379-304

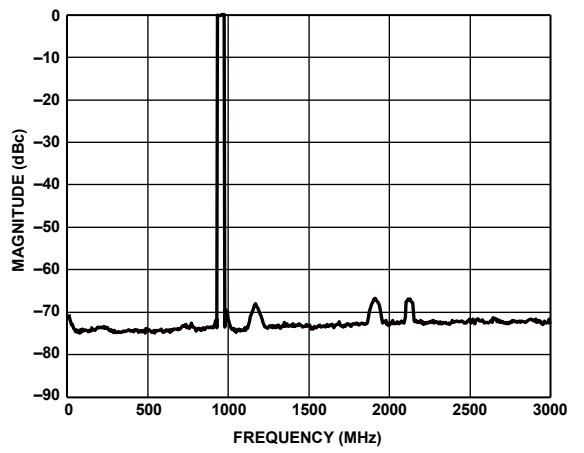

Figure 122. Eight Carriers at 950 MHz Output

14379-003

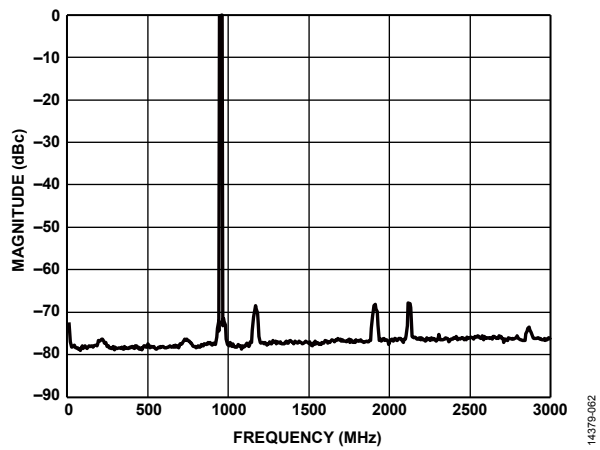

Figure 120. Four Carriers at 950 MHz Output

14379-002

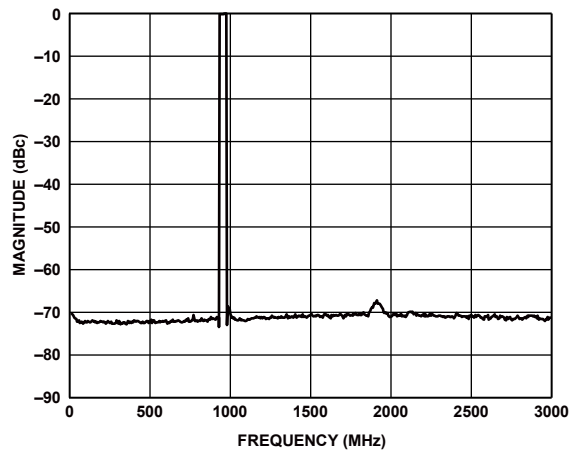

Figure 123. Eight Carriers at 950 MHz Output (Shuffle On)

14379-306

$I_{OUTFS} = 40 \text{ mA}$ ,  $f_{DAC} = 3.076 \text{ GSPS}$ , nominal supplies, FIR85 enabled,  $T_A = 25^\circ\text{C}$ , unless otherwise noted.

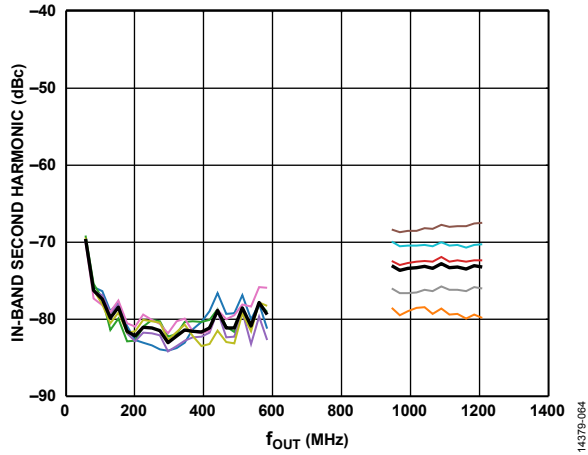

Figure 124. In-Band Second Harmonic vs.  $f_{OUT}$  Performance for One DOCSIS Carrier

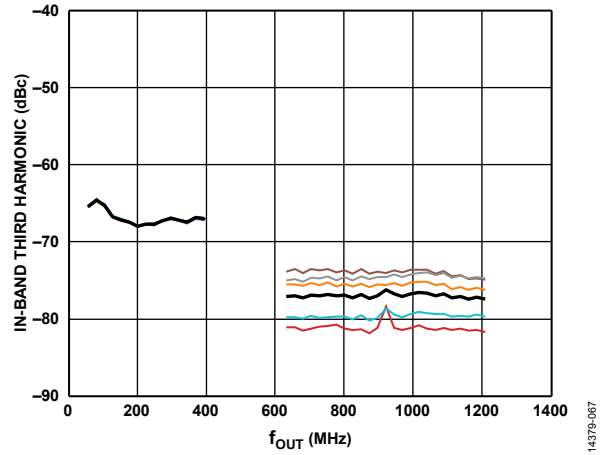

Figure 127. In-Band Third Harmonic vs.  $f_{OUT}$  Performance for One DOCSIS Carrier

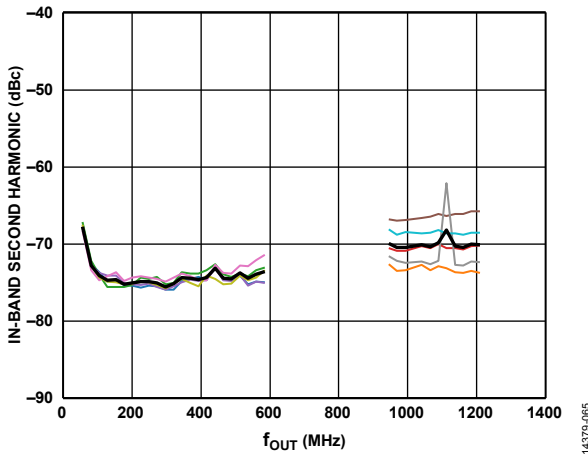

Figure 125. In-Band Second Harmonic vs.  $f_{OUT}$  Performance for Four DOCSIS Carriers

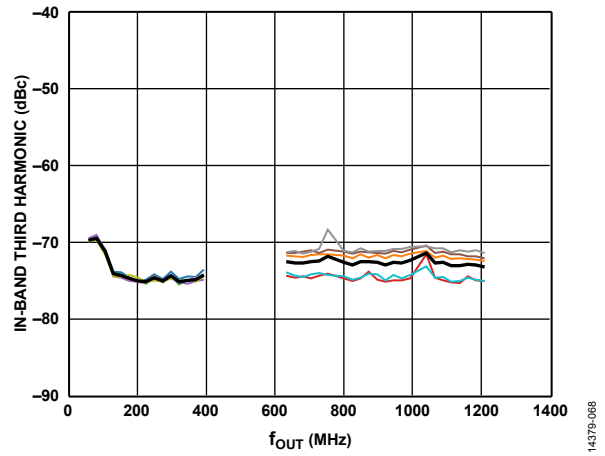

Figure 128. In-Band Third Harmonic vs.  $f_{OUT}$  Performance for Four DOCSIS Carriers

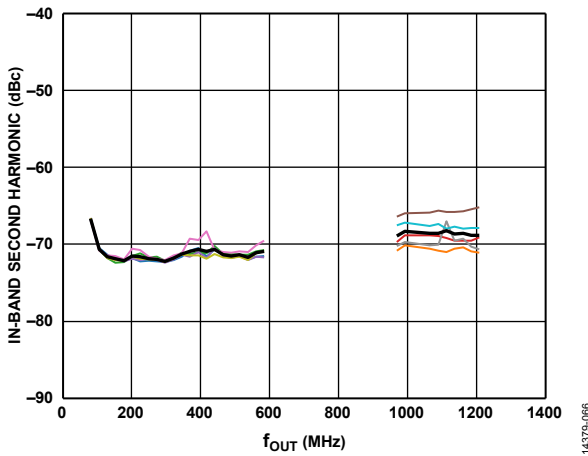

Figure 126. In-Band Second Harmonic vs.  $f_{OUT}$  Performance for Eight DOCSIS Carriers

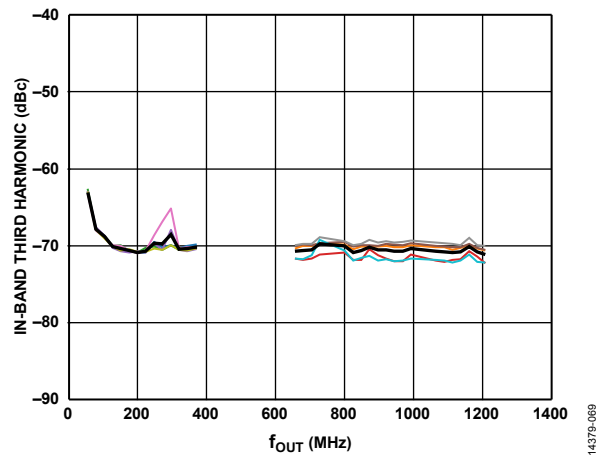

Figure 129. In-Band Third Harmonic vs.  $f_{OUT}$  Performance for Eight DOCSIS Carriers

$I_{OUTFS} = 40 \text{ mA}$ ,  $f_{DAC} = 3.076 \text{ GSPS}$ , nominal supplies, FIR85 enabled,  $T_A = 25^\circ\text{C}$ , unless otherwise noted.

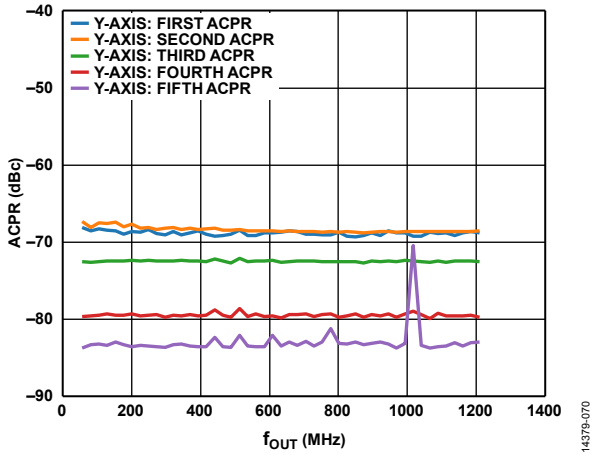

Figure 130. Single-Carrier Adjacent Channel Power Ratio (ACPR) vs.  $f_{OUT}$

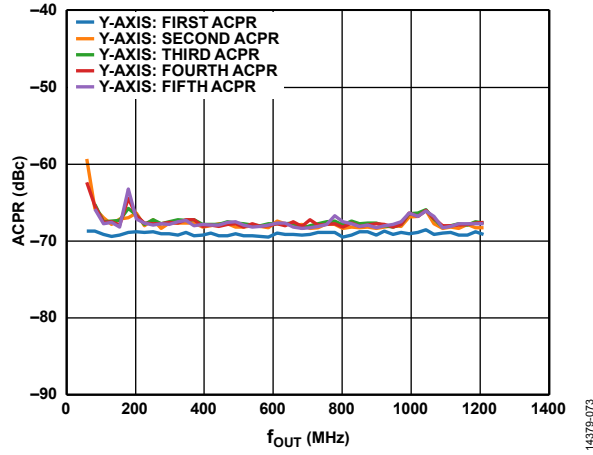

Figure 133. 16-Carrier ACPR vs.  $f_{OUT}$

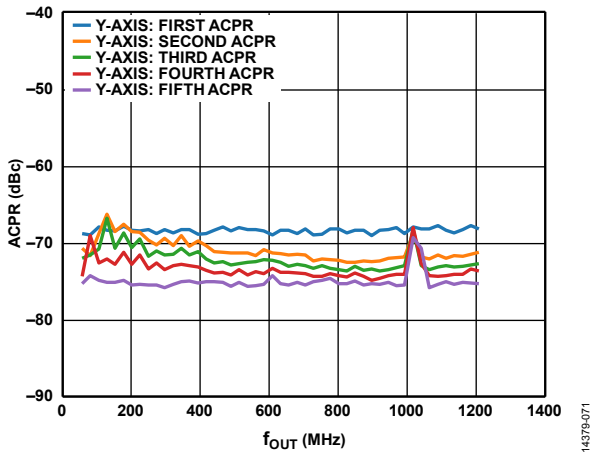

Figure 131. Four-Carrier ACPR vs.  $f_{OUT}$

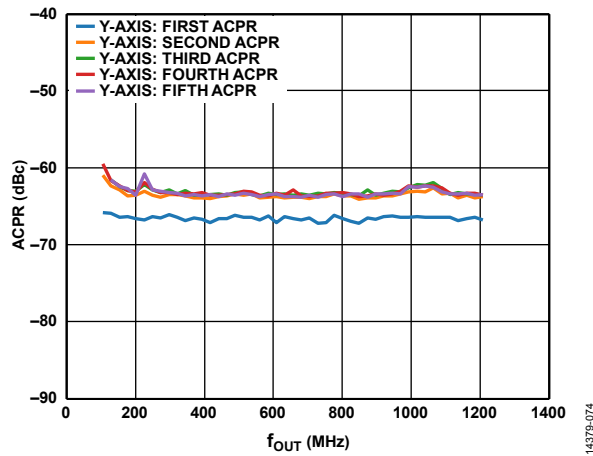

Figure 134. 32-Carrier ACPR vs.  $f_{OUT}$

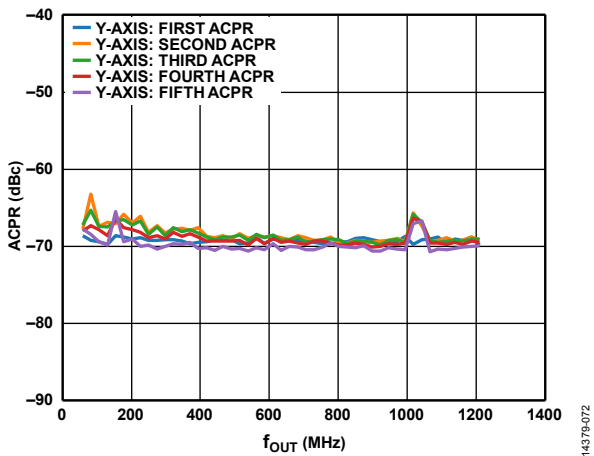

Figure 132. Eight-Carrier ACPR vs.  $f_{OUT}$

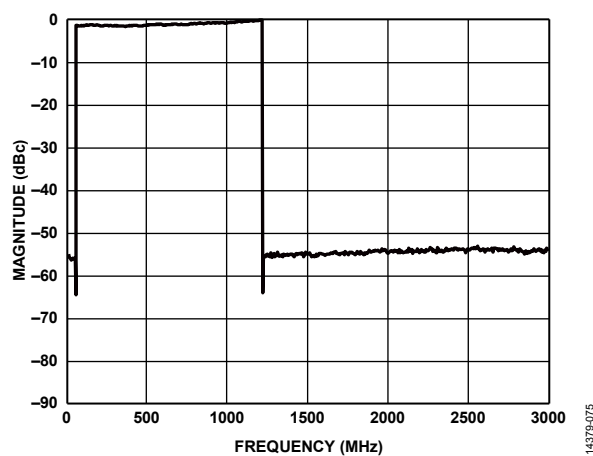

Figure 135. 194-Carrier, Sinc Enabled, FIR85 Enabled



$I_{OUTFS} = 40 \text{ mA}$ ,  $f_{DAC} = 3.076 \text{ GSPS}$ , nominal supplies, FIR85 enabled,  $T_A = 25^\circ\text{C}$ , unless otherwise noted.

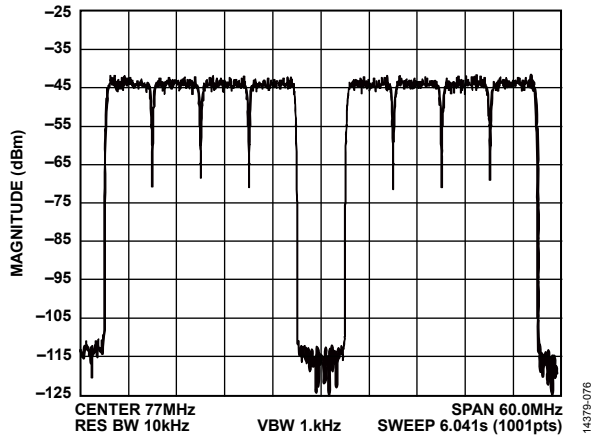

Figure 136. Gap Channel ACLR at 77 MHz

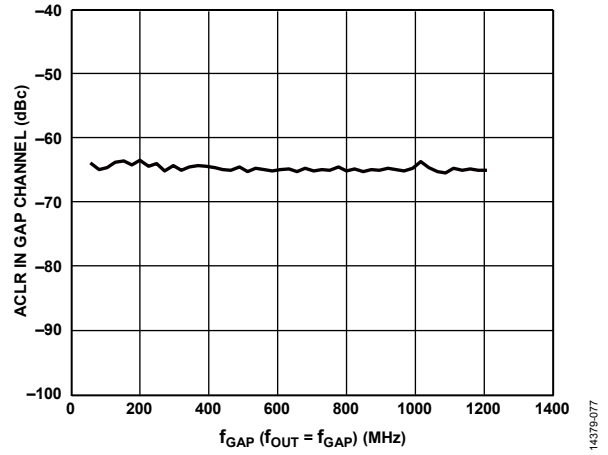

Figure 137. ACLR in Gap Channel vs.  $f_{GAP}$

## TERMINOLOGY

### Integral Nonlinearity (INL)

INL is the maximum deviation of the actual analog output from the ideal output, determined by a straight line drawn from zero scale to full scale.

### Differential Nonlinearity (DNL)

DNL is the measure of the variation in analog value, normalized to full scale, associated with a 1 LSB change in digital input code.

### Offset Error

Offset error is the deviation of the output current from the ideal of 0 mA. For OUTPUT+, 0 mA output is expected when all inputs are set to 0. For OUTPUT-, 0 mA output is expected when all inputs are set to 1.

### Gain Error

Gain error is the difference between the actual and ideal output span. The actual span is determined by the difference between the output when the input is at its minimum code and the output when the input is at its maximum code.

### Temperature Drift

Temperature drift is specified as the maximum change from the ambient (25°C) value to the value at either  $T_{MIN}$  or  $T_{MAX}$ . For offset and gain drift, the drift is reported in ppm of full-scale range (FSR) per degree Celsius. For reference drift, the drift is reported in ppm per degree Celsius.

### Settling Time

Settling time is the time required for the output to reach and remain within a specified error band around its final value, measured from the start of the output transition.

### Spurious-Free Dynamic Range (SFDR)

SFDR is the difference, in decibels, between the peak amplitude of the output signal and the peak spurious signal within the dc to Nyquist frequency of the DAC. Typically, energy in this band is rejected by the interpolation filters. This specification, therefore, defines how well the interpolation filters work and the effect of other parasitic coupling paths on the DAC output.

### Signal-to-Noise Ratio (SNR)

SNR is the ratio of the rms value of the measured output signal to the rms sum of all other spectral components below the Nyquist frequency, excluding the first six harmonics and dc. The value for SNR is expressed in decibels.

### Interpolation Filter

If the digital inputs to the DAC are sampled at a multiple rate of the interpolation rate ( $f_{DATA}$ ), a digital filter can be constructed that has a sharp transition band near  $f_{DATA}/2$ . Images that typically appear around the output data rate ( $f_{DAC}$ ) can be greatly suppressed.

### Adjacent Channel Leakage Ratio (ACLR)

ACLR is the ratio in decibels relative to the carrier (dBc) between the measured power within a channel relative to its adjacent channel.

### Adjusted DAC Update Rate

The adjusted DAC update rate is the DAC update rate divided by the smallest interpolating factor. For clarity on DACs with multiple interpolating factors, the adjusted DAC update rate for each interpolating factor may be given.

### Physical Lane

Physical Lane x refers to SERDINx±.

### Logical Lane

Logical Lane x refers to physical lanes after optionally being remapped by the crossbar block (Register 0x308 to Register 0x30B).

### Link Lane

Link Lane x refers to logical lanes considered in the link.

## THEORY OF OPERATION

The [AD9161/AD9162](#) are 11-bit and 16-bit single RF DACs with a SERDES interface. Figure 1 shows a detailed functional block diagram of the [AD9161/AD9162](#). Eight high speed serial lanes carry data at a maximum speed of 12.5 Gbps, and either a 5 GSPS real input or a 2.5 GSPS complex input data rate to the DAC. Compared to either LVDS or CMOS interfaces, the SERDES interface simplifies pin count, board layout, and input clock requirements to the device.

The clock for the input data is derived from the DAC clock, or device clock (required by the JESD204B specification). This device clock is sourced with a high fidelity direct external DAC sampling clock. The performance of the DAC can be optimized by using on-chip adjustments to the clock input accessible through the SPI port. The device can be configured to operate in one-lane, two-lane, three-lane, four-lane, six-lane, or eight-lane modes, depending on the required input data rate.

The digital datapath of the [AD9161/AD9162](#) offers a bypass (1×) mode ([AD9162](#) only) and several interpolation modes (2×, 3×, 4×, 6×, 8×, 12×, 16×, and 24×) through either an initial half-band (2×) or third-band (3×) filter with programmable 80% or 90% bandwidth, and three subsequent half-band filters (all 90%) with a maximum DAC sample rate of 6 GSPS. An inverse sinc filter is provided to compensate for sinc related roll-off. An additional half-band filter, FIR85, takes advantage of the quad-switch architecture to interpolate on the falling edge of the clock, and effectively double the DAC update rate in 2× NRZ mode. A 48-bit programmable modulus NCO is provided to enable digital frequency shifts of signals with near infinite precision. The NCO can be operated alone in NCO only mode ([AD9162](#) only) or with digital data from the SERDES interface and digital datapath. The 100 MHz speed of the SPI write interface enables rapid updating of the frequency tuning word of the NCO.

The [AD9161/AD9162](#) DAC core provides a fully differential current output with a nominal full-scale current of 38.76 mA. The full-scale output current,  $I_{OUTFS}$ , is user adjustable from 8 mA to 38.76 mA, typically.

The differential current outputs are complementary. The DAC uses the patented quad-switch architecture, which enables DAC decoder options to extend the output frequency range into the second and third Nyquist zones with Mix-Mode, return to zero (RZ) mode, and 2× NRZ mode (with FIR85 enabled). Operating as a real mode DAC in 1× bypass ([AD9162](#) only) and NRZ mode, the output signal can range from 0 Hz to 2.5 GHz. Mix-Mode can be used to access 1.5 GHz to around 7.5 GHz. In the interpolation modes, the output can range from 0 Hz to 6 GHz in 2× NRZ mode using the NCO to shift a signal of up to 1.8 GHz instantaneous bandwidth to the desired  $f_{OUT}$ .

The [AD9161/AD9162](#) are capable of multichip synchronization that can both synchronize multiple DACs and establish a constant and deterministic latency (latency locking) path for the DACs. The latency for each of the DACs remains constant to within several DAC clock cycles from link establishment to link establishment. An external alignment (SYSREF±) signal makes the [AD9161/AD9162](#) Subclass 1 compliant. Several modes of SYSREF± signal handling are available for use in the system.

An SPI configures the various functional blocks and monitors their statuses. The various functional blocks and the data interface must be set up in a specific sequence for proper operation (see the Start-Up Sequence section). Simple SPI initialization routines set up the JESD204B link and are included in the evaluation board package. This data sheet describes the various blocks of the [AD9161/AD9162](#) in greater detail. Descriptions of the JESD204B interface, control parameters, and various registers to set up and monitor the device are provided. The recommended start-up routine reliably sets up the data link.

## SERIAL PORT OPERATION

The serial port is a flexible, synchronous serial communications port that allows easy interfacing with many industry-standard microcontrollers and microprocessors. The serial input/output (I/O) is compatible with most synchronous transfer formats, including both the Motorola SPI and Intel® SSR protocols. The interface allows read/write access to all registers that configure the AD9161/AD9162. MSB first or LSB first transfer formats are supported. The serial port interface can be configured as a 4-wire interface or a 3-wire interface in which the input and output share a single-pin I/O (SDIO).

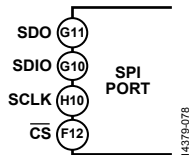

Figure 138. Serial Port Interface Pins (11 mm x 11 mm CSP\_BGA)

There are two phases to a communication cycle with the AD9161/AD9162. Phase 1 is the instruction cycle (the writing of an instruction byte into the device), coincident with the first 16 SCLK rising edges. The instruction word provides the serial port controller with information regarding the data transfer cycle, Phase 2 of the communication cycle. The Phase 1 instruction word defines whether the upcoming data transfer is a read or write, along with the starting register address for the following data transfer.

A logic high on the  $\overline{CS}$  pin followed by a logic low resets the serial port timing to the initial state of the instruction cycle. From this state, the next 16 rising SCLK edges represent the instruction bits of the current I/O operation.

The remaining SCLK edges are for Phase 2 of the communication cycle. Phase 2 is the actual data transfer between the device and the system controller. Phase 2 of the communication cycle is a transfer of one or more data bytes. Eight  $\times$  N SCLK cycles are needed to transfer N bytes during the transfer cycle. Registers change immediately upon writing to the last bit of each transfer byte, except for the frequency tuning word (FTW) and numerically controlled oscillator (NCO) phase offsets, which change only when the frequency tuning word FTW\_LOAD\_REQ bit is set.

### DATA FORMAT

The instruction byte contains the information shown in Table 15.

Table 15. Serial Port Instruction Word

| I15 (MSB) | I[14:0] |
|-----------|---------|
| R/W       | A[14:0] |

R/W, Bit 15 of the instruction word, determines whether a read or a write data transfer occurs after the instruction word write. Logic 1 indicates a read operation, and Logic 0 indicates a write operation.

A14 to A0, Bit I14 to Bit I0 of the instruction word, determine the register that is accessed during the data transfer portion of the communication cycle. For multibyte transfers, A[14:0] is the starting address. The remaining register addresses are generated by the device based on the address increment bit. If the address increment bits are set high (Register 0x000, Bit 5 and Bit 2), multibyte SPI writes start on A[14:0] and increment by 1 every eight bits sent/received. If the address increment bits are set to 0, the address decrements by 1 every eight bits.

### SERIAL PORT PIN DESCRIPTIONS

#### Serial Clock (SCLK)

The serial clock pin synchronizes data to and from the device and runs the internal state machines. The maximum frequency of SCLK is 100 MHz. All data input is registered on the rising edge of SCLK. All data is driven out on the falling edge of SCLK.

#### Chip Select ( $\overline{CS}$ )

An active low input starts and gates a communication cycle.  $\overline{CS}$  allows more than one device to be used on the same serial communications lines. The SDIO pin goes to a high impedance state when this input is high. During the communication cycle, the chip select must stay low.

#### Serial Data I/O (SDIO)

This pin is a bidirectional data line. In 4-wire mode, this pin acts as the data input and SDO acts as the data output.

### SERIAL PORT OPTIONS

The serial port can support both MSB first and LSB first data formats. This functionality is controlled by the LSB first bit (Register 0x000, Bit 6 and Bit 1). The default is MSB first (LSB bit = 0).

When the LSB first bits = 0 (MSB first), the instruction and data bits must be written from MSB to LSB. R/W is followed by A[14:0] as the instruction word, and D[7:0] is the data-word. When the LSB first bits = 1 (LSB first), the opposite is true. A[0:14] is followed by R/W, which is subsequently followed by D[0:7].

The serial port supports a 3-wire or 4-wire interface. When the SDO active bits = 1 (Register 0x000, Bit 4 and Bit 3), a 4-wire interface with a separate input pin (SDIO) and output pin (SDO) is used. When the SDO active bits = 0, the SDO pin is unused and the SDIO pin is used for both the input and the output.

Multibyte data transfers can be performed as well by holding the  $\overline{CS}$  pin low for multiple data transfer cycles (eight SCLKs) after the first data transfer word following the instruction cycle. The first eight SCLKs following the instruction cycle read from or write to the register provided in the instruction cycle. For each additional eight SCLK cycles, the address is either incremented or decremented and the read/write occurs on the new register. The direction of the address can be set using ADDRINC or ADDRINC\_M (Register 0x000, Bit 5 and Bit 2). When ADDRINC

or ADDRINC\_M is 1, the multicycle addresses are incremented. When ADDRINC or ADDRINC\_M is 0, the addresses are decremented. A new write cycle can always be initiated by bringing CS high and then low again.

To prevent confusion and to ensure consistency between devices, the chip tests the first nibble following the address phase, ignoring the second nibble. This test is completed independently from the LSB first bits and ensures that there are extra clock cycles following the soft reset bits (Register 0x000, Bit 0 and Bit 7). This test of the first nibble only applies when writing to Register 0x000.

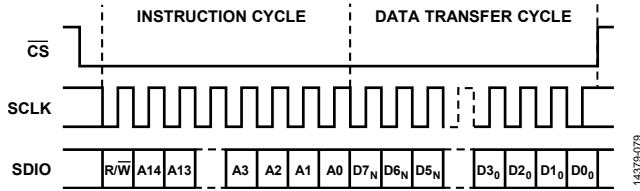

Figure 139. Serial Register Interface Timing, MSB First, Register 0x000, Bit 5 and Bit 2 = 0

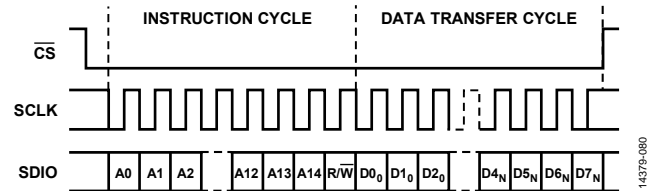

Figure 140. Serial Register Interface Timing, LSB First, Register 0x000, Bit 5 and Bit 2 = 1

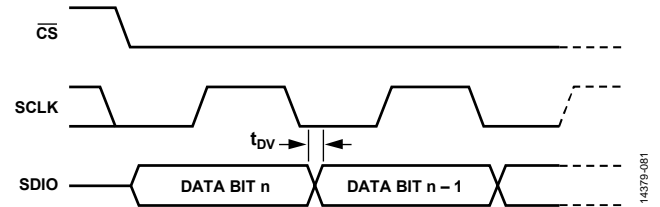

Figure 141. Timing Diagram for Serial Port Register Read

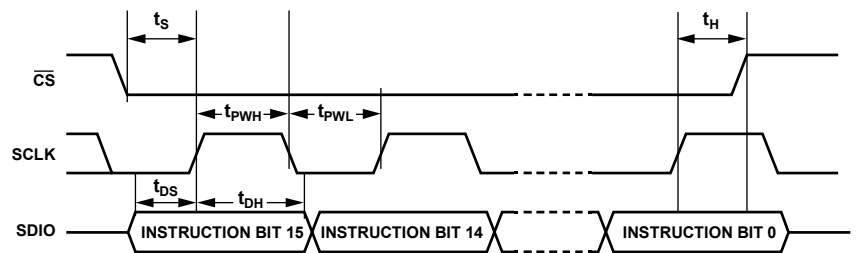

Figure 142. Timing Diagram for Serial Port Register Write

# JESD204B SERIAL DATA INTERFACE

## JESD204B OVERVIEW

The AD9161/AD9162 have eight JESD204B data ports that receive data. The eight JESD204B ports can be configured as part of a single JESD204B link that uses a single system reference (SYSREF±) and device clock (CLK±).

The JESD204B serial interface hardware consists of three layers: the physical layer, the data link layer, and the transport layer. These sections of the hardware are described in subsequent sections, including information for configuring every aspect of the interface. Figure 143 shows the communication layers implemented in the AD9161/AD9162 serial data interface to recover the clock and deserialize, descramble, and deframe the data before it is sent to the digital signal processing section of the device.

The physical layer establishes a reliable channel between the transmitter (Tx) and the receiver (Rx); the data link layer is responsible for unpacking the data into octets and descrambling the data. The transport layer receives the descrambled JESD204B frames and converts them to DAC samples.

A number of JESD204B parameters (L, F, K, M, N, NP, S, HD) define how the data is packed and tell the device how to turn the serial data into samples. These parameters are defined in detail in the Transport Layer section. The AD9161/AD9162 also have a descrambling option (see the Descrambler section for more information).

The various combinations of JESD204B parameters that are supported depend solely on the number of lanes. Thus, a unique set of parameters can be determined by selecting the lane count to be used. In addition, the interpolation rate and number of lanes can be used to define the rest of the configuration needed to set up the AD9161/AD9162. The interpolation rate and the number of lanes are selected in Register 0x110.

The AD9161/AD9162 have a single DAC output; however, for the purposes of the complex signal processing on chip, the converter count is defined as  $M = 2$  whenever interpolation is used.

For a particular application, the number of converters to use (M) and the DataRate variable are known. The LaneRate variable and number of lanes (L) can be traded off as follows:

$$DataRate = (DACRate)/(InterpolationFactor)$$

$$LaneRate = (20 \times DataRate \times M)/L$$

where LaneRate must be between 750 Mbps and 12.5 Gbps.

Achieving and recovering synchronization of the lanes is very important. To simplify the interface to the transmitter, the AD9161/AD9162 designate a master synchronization signal for each JESD204B link. The SYNCOUT± pin is used as the master signal for all lanes. If any lane in a link loses synchronization, a resynchronization request is sent to the transmitter via the synchronization signal of the link. The transmitter stops sending data and instead sends synchronization characters to all lanes in that link until resynchronization is achieved.

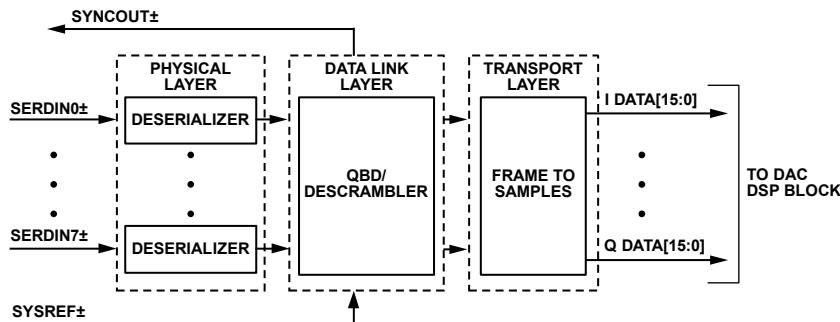

Figure 143. Functional Block Diagram of Serial Link Receiver

Table 16. Single-Link JESD204B Operating Modes

| Parameter                           | Number of Lanes (L) |   |   |   |   |                       |
|-------------------------------------|---------------------|---|---|---|---|-----------------------|
|                                     | 1                   | 2 | 3 | 4 | 6 | 8                     |
| L (Lane Count)                      | 1                   | 2 | 3 | 4 | 6 | 8                     |
| M (Converter Count)                 | 2                   | 2 | 2 | 2 | 2 | 1 (real), 2 (complex) |
| F (Octets per Frame per Lane)       | 4                   | 2 | 4 | 1 | 2 | 1                     |
| S (Samples per Converter per Frame) | 1                   | 1 | 3 | 1 | 3 | 4 (real), 2 (complex) |

Table 17. Data Structure per Lane for JESD204B Operating Modes<sup>1</sup>

| JESD204B Parameters        | Lane No.   | Frame 0  | Frame 1  | Frame 2                                | Frame 3                             |
|----------------------------|--|--|--|--|-------------------------------------|
| L = 8, M = 1, F = 1, S = 4 | Lane 0<br>Lane 1<br>Lane 2<br>Lane 3<br>Lane 4<br>Lane 5<br>Lane 6<br>Lane 7 | MOS0[15:8]<br>MOS0[7:0]<br>MOS1[15:8]<br>MOS1[7:0]<br>MOS2[15:8]<br>MOS2[7:0]<br>MOS3[15:8]<br>MOS3[7:0] |  |  |                                     |
| L = 8, M = 2, F = 1, S = 2 | Lane 0<br>Lane 1<br>Lane 2<br>Lane 3<br>Lane 4<br>Lane 5<br>Lane 6<br>Lane 7 | MOS0[15:8]<br>MOS0[7:0]<br>MOS1[15:8]<br>MOS1[7:0]<br>M1S0[15:8]<br>M1S0[7:0]<br>M1S1[15:8]<br>M1S1[7:0] |  |  |                                     |
| L = 6, M = 2, F = 2, S = 3 | Lane 0<br>Lane 1<br>Lane 2<br>Lane 3<br>Lane 4<br>Lane 5                     | MOS0[15:8]<br>MOS1[15:8]<br>MOS2[15:8]<br>M1S0[15:8]<br>M1S1[15:8]<br>M1S2[15:8]                         | MOS0[7:0]<br>MOS1[7:0]<br>MOS2[7:0]<br>M1S0[7:0]<br>M1S1[7:0]<br>M1S2[7:0] |  |                                     |
| L = 4, M = 2, F = 1, S = 1 | Lane 0<br>Lane 1<br>Lane 2<br>Lane 3   | MOS0[15:8]<br>MOS0[7:0]<br>M1S0[15:8]<br>M1S0[7:0]   |  |  |                                     |
| L = 3, M = 2, F = 4, S = 3 | Lane 0<br>Lane 1<br>Lane 2   | MOS0[15:8]<br>MOS2[15:8]<br>M1S1[15:8]   | MOS0[7:0]<br>MOS2[7:0]<br>M1S1[7:0]  | MOS1[15:8]<br>M1S0[15:8]<br>M1S2[15:8] | MOS1[7:0]<br>M1S0[7:0]<br>M1S2[7:0] |
| L = 2, M = 2, F = 2, S = 1 | Lane 0<br>Lane 1   | MOS0[15:8]<br>M1S0[15:8]   | MOS0[7:0]<br>M1S0[7:0]   |  |                                     |
| L = 1, M = 2, F = 4, S = 1 | Lane 0   | MOS0[15:8]   | MOS0[7:0]  | M1S0[15:8]                             | M1S0[7:0]                           |

<sup>1</sup> Mx is the converter number and Sy is the sample number. For example, MOS0 means Converter 0, Sample 0. Blank cells are not applicable.

**PHYSICAL LAYER**

The physical layer of the JESD204B interface, hereafter referred to as the deserializer, has eight identical channels. Each channel consists of the terminators, an equalizer, a clock and data recovery (CDR) circuit, and the 1:40 demux function (see Figure 144).

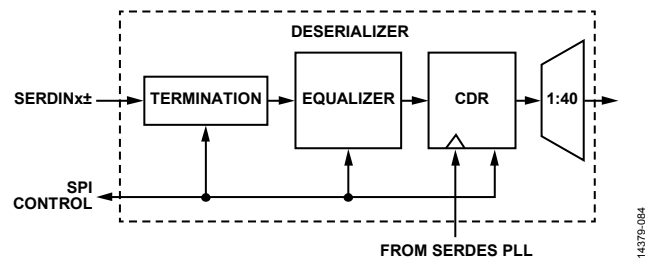

Figure 144. Deserializer Block Diagram

JESD204B data is input to the AD9161/AD9162 via the SERDINx± 1.2 V differential input pins as per the JESD204B specification.

**Interface Power-Up and Input Termination**

Before using the JESD204B interface, it must be powered up by setting Register 0x200, Bit 0 = 0. In addition, each physical lane (PHY) that is not being used (SERDINx±) must be powered down. To do so, set the corresponding Bit x for Physical Lane x in Register 0x201 to 0 if the physical lane is being used, and to 1 if it is not being used.

The AD9161/AD9162 autocalibrate the input termination to 50 Ω. Before running the termination calibration, Register 0x2A7 and Register 0x2AE must be written as described in Table 18 to guarantee proper calibration. The termination calibration begins when Register 0x2A7, Bit 0 and Register 0x2AE, Bit 0 transition from low to high. Register 0x2A7 controls autocalibration for

PHY 0, PHY 1, PHY 6, and PHY 7. Register 0x2AE controls autocalibration for PHY 2, PHY 3, PHY 4, and PHY 5.

The PHY termination autocalibration routine is as shown in Table 18.

**Table 18. PHY Termination Autocalibration Routine**

| Address | Value | Description  |
|---------|-------|--|
| 0x2A7   | 0x01  | Autotune PHY 0, PHY 1, PHY 6, and PHY 7 terminations |
| 0x2AE   | 0x01  | Autotune PHY 2, PHY 3, PHY 4, and PHY 5 terminations |

The input termination voltage of the DAC is sourced externally via the VTT\_1P2 pins (M3 and M 13 on the 8 mm × 8 mm BGA package, or K3 and K13 on the 11 mm × 11 mm BGA package). Set  $V_{TT}$ , the termination voltage, by connecting it to VDD\_1P2. It is recommended that the JESD204B inputs be ac-coupled to the JESD204B transmit device using 100 nF capacitors.

The calibration code of the termination can be read from Bits[3:0] in Register 0x2AC (PHY 0, PHY 1, PHY 6, PHY 7) and Register 0x2B3 (PHY 2, PHY 3, PHY 4, PHY 5). If needed, the termination values can be adjusted or set using several registers. The TERM\_BLKx\_CTRLREG1 registers (Register 0x2A8 and Register 0x2AF), can override the autocalibrated value. When set to 0xFFFFXXXX, the termination block autocalibrates, which is the normal, default setting. When set to 0xFFFF1XXXX, the autocalibration value is overwritten with the value in Bits[3:1] of Register 0x2A8 and Register 0x2AF. Individual offsets from the autocalibration value for each lane can be programmed in Bits[3:0] of Register 0x2BB to Register 0x2C2. The value is a signed magnitude, with Bit 3 as the sign bit. The total range of the termination resistor value is about 94 Ω to 120 Ω, with approximately 3.5% increments across the range (for example, smaller steps at the bottom of the range than at the top).

**Receiver Eye Mask**

The AD9161/AD9162 comply with the JESD204B specification regarding the receiver eye mask and is capable of capturing data that complies with this mask. Figure 145 shows the receiver eye mask normalized to the data rate interval with a 600 mV  $V_{TT}$  swing. See the JESD204B specification for more information regarding the eye mask and permitted receiver eye opening.

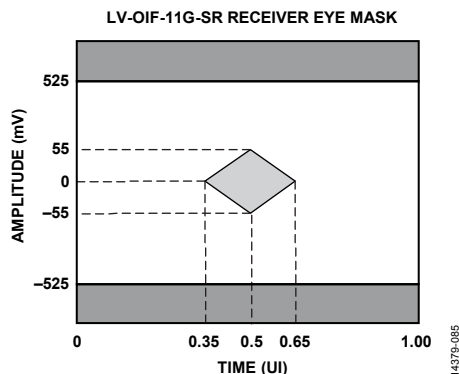

Figure 145. Receiver Eye Mask for 600 mV  $V_{TT}$  Swing

**Clock Relationships**

The following clocks rates are used throughout the rest of the JESD204B section. The relationship between any of the clocks can be derived from the following equations:

$$DataRate = (DACRate)/(InterpolationFactor)$$

$$LaneRate = (20 \times DataRate \times M)/L$$

$$ByteRate = LaneRate/10$$

This relationship comes from 8-bit/10-bit encoding, where each byte is represented by 10 bits.

$$PCLK\ Rate = ByteRate/4$$

The processing clock is used for a quad-byte decoder.

$$FrameRate = ByteRate/F$$

where  $F$  is defined as octets per frame per lane.

$$PCLK\ Factor = FrameRate/PCLK\ Rate = 4/F$$

where:

$M$  is the JESD204B parameter for converters per link.

$L$  is the JESD204B parameter for lanes per link.

$F$  is the JESD204B parameter for octets per frame per lane.

**SERDES PLL**

**Functional Overview of the SERDES PLL**

The independent SERDES PLL uses integer N techniques to achieve clock synthesis. The entire SERDES PLL is integrated on chip, including the VCO and the loop filter. The SERDES PLL VCO operates over the range of 6 GHz to 12.5 GHz.

In the SERDES PLL, a VCO divider block divides the VCO clock by 2 to generate a 3 GHz to 6.25 GHz quadrature clock for the deserializer cores. This clock is the input to the clock and data recovery block that is described in the Clock and Data Recovery section.

The reference clock to the SERDES PLL is always running at a frequency,  $f_{REF}$ , which is equal to 1/40 of the lane rate (PCLK Rate). This clock is divided by a DivFactor value (set by SERDES\_PLL\_DIV\_FACTOR) to deliver a clock to the phase frequency detector (PFD) block that is between 35 MHz and 80 MHz. Table 19 includes the respective SERDES\_PLL\_DIV\_FACTOR register settings for each of the desired PLL\_REF\_CLK\_RATE options available.

**Table 19. SERDES PLL Divider Settings**

| Lane Rate (Gbps) | PLL_REF_CLK_RATE, Register 0x084, Bits[5:4] | SERDES_PLL_DIV_FACTOR Register 0x289, Bits[1:0] |
|------------------|---|---|
| 0.750 to 1.5625  | 0b01 = 2×                                   | 0b10 = ±1                                       |
| 1.5 to 3.125     | 0b00 = 1×                                   | 0b10 = ±1                                       |
| 3 to 6.25        | 0b00 = 1×                                   | 0b01 = ±2                                       |
| 6 to 12.5        | 0b00 = 1×                                   | 0b00 = ±4                                       |



Register 0x280 controls the synthesizer enable and recalibration.

To enable the SERDES PLL, first set the PLL divider register (see Table 19). Then enable the SERDES PLL by writing Register 0x280, Bit 0 = 1. If a recalibration is needed, write Register 0x280, Bit 2 = 0b1 and then reset the bit to 0b0. The rising edge of the bit causes a recalibration to begin.

Confirm that the SERDES PLL is working by reading Register 0x281. If Register 0x281, Bit 0 = 1, the SERDES PLL has locked. If Register 0x281, Bit 3 = 1, the SERDES PLL was successfully calibrated. If Register 0x281, Bit 4 or Bit 5 is high, the PLL reaches the lower or upper end of its calibration band and must be recalibrated by writing 0 and then 1 to Register 0x280, Bit 2.

**Clock and Data Recovery**

The deserializer is equipped with a CDR circuit. Instead of recovering the clock from the JESD204B serial lanes, the CDR recovers the clocks from the SERDES PLL. The 3 GHz to 6.25 GHz output from the SERDES PLL, shown in Figure 146, is the input to the CDR.

A CDR sampling mode must be selected to generate the lane rate clock inside the device. If the desired lane rate is greater than 6.25 GHz, half rate CDR operation must be used. If the desired lane rate is less than 6.25 GHz, disable half rate operation. If the lane rate is less than 3 GHz, disable full rate and enable 2x oversampling to recover the appropriate lane rate clock. Table 20 gives a breakdown of CDR sampling settings that must be set depending on the LaneRate value.

**Table 20. CDR Operating Modes**

| LaneRate (Gbps) | SPI_ENHALFRATE Register 0x230, Bit 5 | SPI_DIVISION_RATE, Register 0x230, Bits[2:1] |
|-----------------|--------------------------------------|--|
| 0.750 to 1.5625 | 0 (full rate)                        | 10b (divide by 4)                            |
| 1.5 to 3.125    | 0 (full rate)                        | 01b (divide by 2)                            |
| 3 to 6.25       | 0 (full rate)                        | 00b (no divide)                              |
| 6 to 12.5       | 1 (half rate)                        | 00b (no divide)                              |

The CDR circuit synchronizes the phase used to sample the data on each serial lane independently. This independent phase adjustment per serial interface ensures accurate data sampling and eases the implementation of multiple serial interfaces on a PCB.

After configuring the CDR circuit, reset it and then release the reset by writing 1 and then 0 to Register 0x206, Bit 0.

**Power-Down Unused PHYs**

Note that any unused and enabled lanes consume extra power unnecessarily. Each lane that is not being used (SERDINx±) must be powered off by writing a 1 to the corresponding bit of PHY\_PD (Register 0x201).

**Equalization**

To compensate for signal integrity distortions for each PHY channel due to PCB trace length and impedance, the AD9161/AD9162 employ an easy to use, low power equalizer on each JESD204B channel. The AD9161/AD9162 equalizers can compensate for insertion losses far greater than required by the JESD204B specification. The equalizers have two modes of operation that are determined by the EQ\_POWER\_MODE register setting in Register 0x268, Bits[7:6]. In low power mode (Register 0x268, Bits[7:6] = 2b'01) and operating at the maximum lane rate of 12.5 GBPS, the equalizer can compensate for up to 11.5 dB of insertion loss. In normal mode (Register 0x268, Bits[7:6] = 2b'00), the equalizer can compensate for up to 17.2 dB of insertion loss. This performance is shown in Figure 147 as an overlay to the JESD204B specification for insertion loss. Figure 147 shows the equalization performance at 12.5 Gbps, near the maximum baud rate for the AD9161/AD9162.

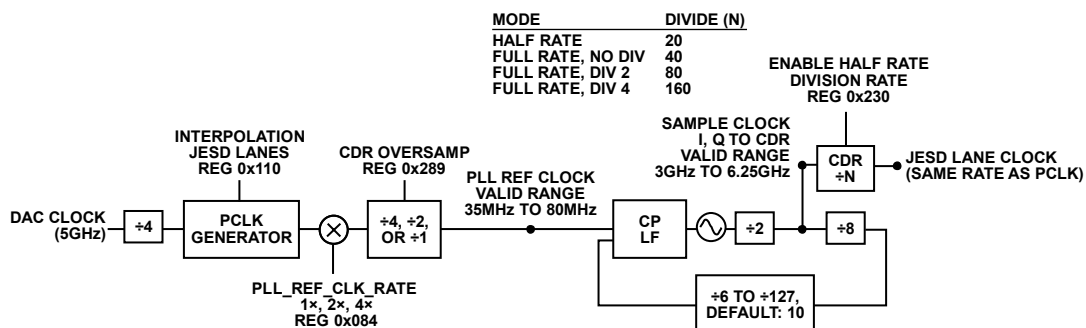

Figure 146. SERDES PLL Synthesizer Block Diagram Including VCO Divider Block

Figure 148 and Figure 149 are provided as points of reference for hardware designers and show the insertion loss for various lengths of well laid out stripline and microstrip transmission lines, respectively. See the Hardware Considerations section for specific layout recommendations for the JESD204B channel.

Low power mode is recommended if the insertion loss of the JESD204B PCB channels is less than that of the most lossy supported channel for low power mode (shown in Figure 147). If the insertion loss is greater than that, but still less than that of the most lossy supported channel for normal mode (shown in Figure 147), use normal mode. At 12.5 Gbps operation, the equalizer in normal mode consumes about 4 mW more power per lane used than in low power equalizer mode. Note that either mode can be used in conjunction with transmitter preemphasis to ensure functionality and/or optimize for power.

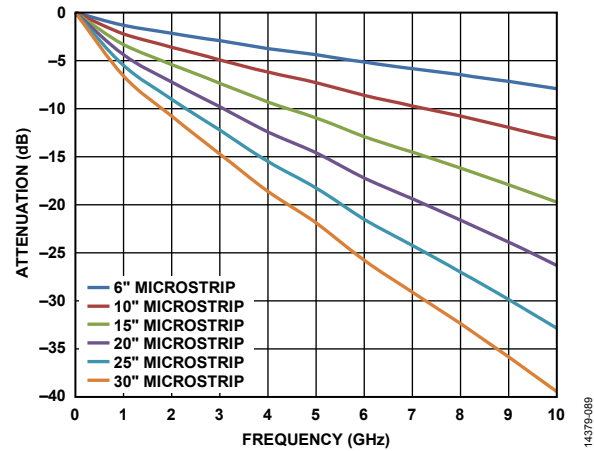

Figure 149. Insertion Loss of 50  $\Omega$  Microstrips on FR4

**DATA LINK LAYER**

The data link layer of the AD9161/AD9162 JESD204B interface accepts the deserialized data from the PHYs and deframes, and descrambles them so that data octets are presented to the transport layer to be put into DAC samples. The architecture of the data link layer is shown in Figure 150. The data link layer consists of a synchronization FIFO for each lane, a crossbar switch, a deframer, and a descrambler.

The AD9161/AD9162 can operate as a single-link high speed JESD204B serial data interface. All eight lanes of the JESD204B interface handle link layer communications such as code group synchronization (CGS), frame alignment, and frame synchronization.

The AD9161/AD9162 decode 8-bit/10-bit control characters, allowing marking of the start and end of the frame and alignment between serial lanes. Each AD9161/AD9162 serial interface link can issue a synchronization request by setting its SYNCOUT± signal low. The synchronization protocol follows Section 4.9 of the JESD204B standard. When a stream of four consecutive /K/ symbols is received, the AD9161/AD9162 deactivates the synchronization request by setting the SYNCOUT± signal high at the next internal LMFC rising edge. Then, AD9161/AD9162 wait for the transmitter to issue an initial lane alignment sequence (ILAS). During the ILAS, all lanes are aligned using the /A/ to /R/ character transition as described in the JESD204B Serial Link Establishment section. Elastic buffers hold early arriving lane data until the alignment character of the latest lane arrives. At this point, the buffers for all lanes are released and all lanes are aligned (see Figure 151).

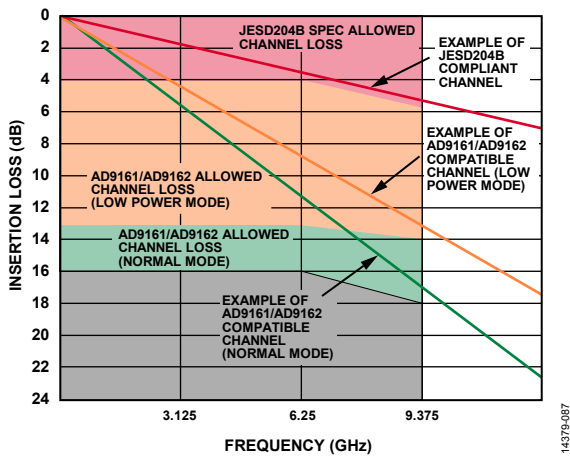

Figure 147. Insertion Loss Allowed

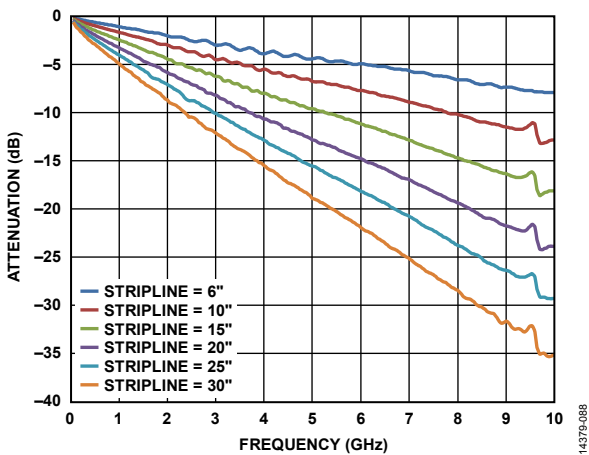

Figure 148. Insertion Loss of 50  $\Omega$  Striplines on FR4

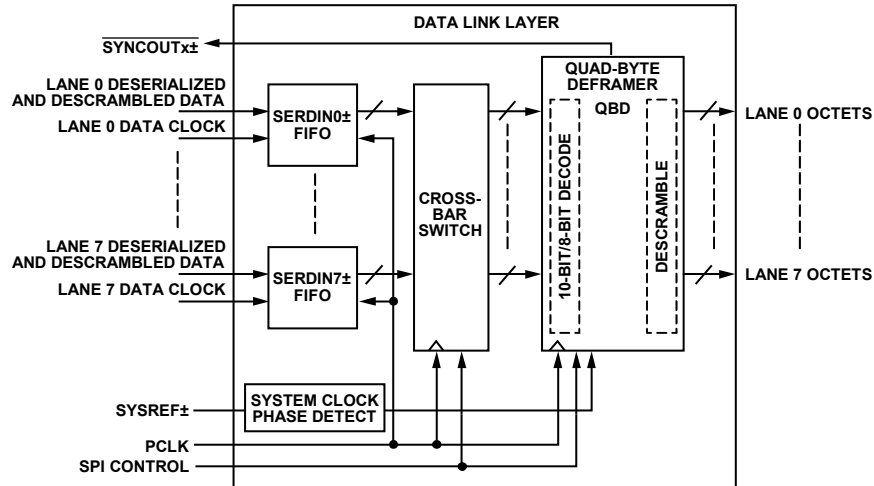

Figure 150. Data Link Layer Block Diagram

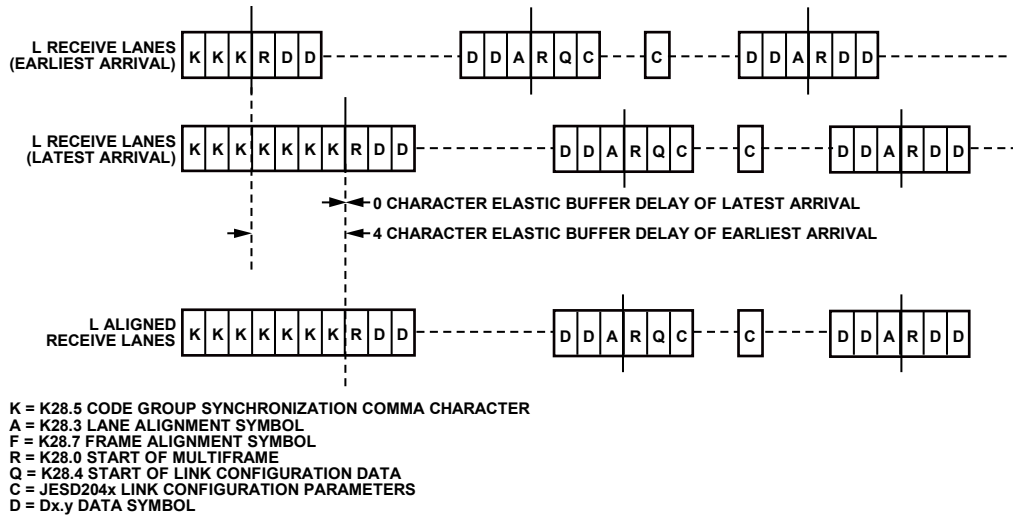

Figure 151. Lane Alignment During ILAS

**JESD204B Serial Link Establishment**

A brief summary of the high speed serial link establishment process for Subclass 1 is provided. See Section 5.3.3 of the JESD204B specifications document for complete details.

**Step 1: Code Group Synchronization**

Each receiver must locate /K/ (K28.5) characters in its input data stream. After four consecutive /K/ characters are detected on all link lanes, the receiver block deasserts the SYNCOUT± signal to the transmitter block at the receiver LMFC edge.

The transmitter captures the change in the SYNCOUT± signal and at a future transmitter LMFC rising edge starts the ILAS.

**Step 2: Initial Lane Alignment Sequence**

The main purposes of this phase are to align all the lanes of the link and to verify the parameters of the link.

Before the link is established, write each of the link parameters to the receiver device to designate how data is sent to the receiver block.

The ILAS consists of four or more multiframes. The last character of each multiframe is a multiframe alignment character, /A/. The first, third, and fourth multiframes are populated with predetermined data values. Note that Section 8.2 of the JESD204B specifications document describes the data ramp that is expected during ILAS. The AD9161/AD9162 do not require this ramp. The deframer uses the final /A/ of each lane to align the ends of the multiframes within the receiver. The second multiframe contains an /R/ (K.28.0), /Q/ (K.28.4), and then data corresponding to the link parameters. Additional multiframes can be added to the ILAS if needed by the receiver. By default, the AD9161/AD9162 use four multiframes in the ILAS (this can be changed in Register 0x478). If using Subclass 1, exactly four multiframes must be used.

After the last /A/ character of the last ILAS, multiframe data begins streaming. The receiver adjusts the position of the /A/ character such that it aligns with the internal LMFC of the receiver at this point.

### Step 3: Data Streaming

In this phase, data is streamed from the transmitter block to the receiver block.

Optionally, data can be scrambled. Scrambling does not start until the very first octet following the ILAS.

The receiver block processes and monitors the data it receives for errors, including the following:

- Bad running disparity (8-bit/10-bit error)
- Not in table (8-bit/10-bit error)
- Unexpected control character
- Bad ILAS
- Interlane skew error (through character replacement)

If any of these errors exist, they are reported back to the transmitter in one of the following ways (see the JESD204B Error Monitoring section for details):

- $\overline{\text{SYNCOUT}}_{\pm}$  signal assertion: resynchronization ( $\overline{\text{SYNCOUT}}_{\pm}$  signal pulled low) is requested at each error for the last two errors. For the first three errors, an optional resynchronization request can be asserted when the error counter reaches a set error threshold.
- For the first three errors, each multiframe with an error in it causes a small pulse on  $\overline{\text{SYNCOUT}}_{\pm}$ .
- Errors can optionally trigger an interrupt request (IRQ) event, which can be sent to the transmitter.

For more information about the various test modes for verifying the link integrity, see the JESD204B Test Modes section.

#### Lane FIFO

The FIFOs in front of the crossbar switch and deframer synchronize the samples sent on the high speed serial data interface with the deframer clock by adjusting the phase of the incoming data. The FIFO absorbs timing variations between the data source and the deframer; this allows up to two PCLK cycles of drift from the transmitter. The FIFO\_STATUS\_REG\_0 register and FIFO\_STATUS\_REG\_1 register (Register 0x30C and Register 0x30D, respectively) can be monitored to identify whether the FIFOs are full or empty.

#### Lane FIFO IRQ

An aggregate lane FIFO error bit is also available as an IRQ event. Use Register 0x020, Bit 2 to enable the FIFO error bit, and then use Register 0x024, Bit 2 to read back its status and reset the IRQ signal. See the Interrupt Request Operation section for more information.

#### Crossbar Switch

Register 0x308 to Register 0x30B allow arbitrary mapping of physical lanes (SERDIN $x_{\pm}$ ) to logical lanes used by the SERDES deframers.

**Table 21. Crossbar Registers**

| Address | Bits  | Logical Lane |
|---------|-------|--------------|
| 0x308   | [2:0] | SRC_LANE0    |
| 0x308   | [5:3] | SRC_LANE1    |
| 0x309   | [2:0] | SRC_LANE2    |
| 0x309   | [5:3] | SRC_LANE3    |
| 0x30A   | [2:0] | SRC_LANE4    |
| 0x30A   | [5:3] | SRC_LANE5    |
| 0x30B   | [2:0] | SRC_LANE6    |
| 0x30B   | [5:3] | SRC_LANE7    |

Write each SRC\_LANE $y$  with the number ( $x$ ) of the desired physical lane (SERDIN $x_{\pm}$ ) from which to obtain data. By default, all logical lanes use the corresponding physical lane as their data source. For example, by default, SRC\_LANE0 = 0; therefore, Logical Lane 0 obtains data from Physical Lane 0 (SERDIN0 $\pm$ ). To use SERDIN4 $\pm$  as the source for Logical Lane 0 instead, the user must write SRC\_LANE0 = 4.

#### Lane Inversion

Register 0x334 allows inversion of desired logical lanes, which can be used to ease routing of the SERDIN $x_{\pm}$  signals. For each Logical Lane  $x$ , set Bit  $x$  of Register 0x334 to 1 to invert it.

#### Deframer

The AD9161/AD9162 consist of one quad-byte deframer (QBD). The deframer accepts the 8-bit/10-bit encoded data from the deserializer (via the crossbar switch), decodes it, and descrambles it into JESD204B frames before passing it to the transport layer to be converted to DAC samples. The deframer processes four symbols (or octets) per processing clock (PCLK) cycle.

The deframer uses the JESD204B parameters that the user has programmed into the register map to identify how the data is packed, and unpacks it. The JESD204B parameters are described in detail in the Transport Layer section; many of the parameters are also needed in the transport layer to convert JESD204B frames into samples.

#### Descrambler

The AD9161/AD9162 provide an optional descrambler block using a self synchronous descrambler with the following polynomial:  $1 + x^{14} + x^{15}$ .

Enabling data scrambling reduces spectral peaks that are produced when the same data octets repeat from frame to frame. It also makes the spectrum data independent so that possible frequency selective effects on the electrical interface do not cause data dependent errors. Descrambling of the data is enabled by setting the SCR bit (Register 0x453, Bit 7) to 1.

### Syncing LMFC Signals

The first step in guaranteeing synchronization across links and devices begins with syncing the LMFC signals. In Subclass 0, the LMFC signal is synchronized to an internal processing clock. In Subclass 1, LMFC signals are synchronized to an external SYSREF± signal.

#### SYSREF± Signal

The SYSREF± signal is a differential source synchronous input that synchronizes the LMFC signals in both the transmitter and receiver in a JESD204B Subclass 1 system to achieve deterministic latency.

The SYSREF± signal is a rising edge sensitive signal that is sampled by the device clock rising edge. It is best practice that the device clock and SYSREF± signals be generated by the same source, such as the HMC7044 clock generator, so that the phase alignment between the signals is fixed. When designing for optimum deterministic latency operation, consider the timing distribution skew of the SYSREF± signal in a multipoint link system (multichip).

The AD9161/AD9162 support a periodic SYSREF± signal. The periodicity can be continuous, strobed, or gapped periodic. The SYSREF± signal can always be dc-coupled (with a common-mode voltage of 0 V to 1.25 V). When dc-coupled, a small amount of common-mode current (<500 µA) is drawn from the SYSREF± pins. See Figure 152 and Figure 153 for the SYSREF± internal circuit.

To avoid this common-mode current draw, use a 50% duty cycle periodic SYSREF± signal with ac coupling capacitors. If ac-coupled, the ac coupling capacitors combine with the resistors shown in Figure 152 or Figure 153 to make a high-pass filter with an RC time constant of  $\tau = RC$ . Select C such that  $\tau > 4/\text{SYSREF}\pm$  frequency. In addition, the edge rate must be sufficiently fast to meet the SYSREF± vs. DAC clock keep out window (KOW) requirements.

It is possible to use ac-coupled mode without meeting the frequency to time constant constraints ( $\tau = RC$  and  $\tau > 4/\text{SYSREF}\pm$  frequency) by using SYSREF± hysteresis (Register 0x088 and Register 0x089). However, using hysteresis increases the DAC clock KOW (Table 6 does not apply) by an amount depending on the SYSREF± frequency, level of hysteresis, capacitor choice, and edge rate.

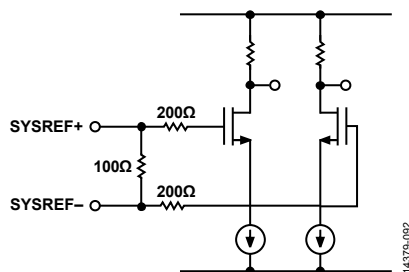

Figure 152. SYSREF± Input Circuit for the 8 mm × 8 mm 165-Ball BGA

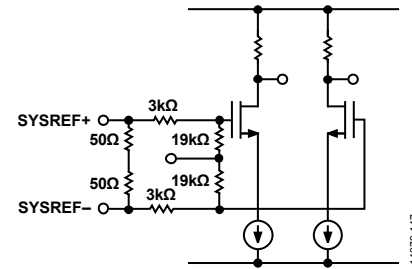

Figure 153. SYSREF± Input Circuit for the 11 mm × 11 mm 169-Ball BGA

### Sync Processing Modes Overview

The AD9161/AD9162 support several LMFC sync processing modes. These modes are one-shot, continuous, and monitor modes. All sync processing modes perform a phase check to confirm that the LMFC is phase aligned to an alignment edge. In Subclass 1, the SYSREF± rising edge acts as the alignment edge; in Subclass 0, an internal processing clock acts as the alignment edge.

The SYSREF± signal is sampled by a divide by 4 version of the DAC clock. After SYSREF± is sampled, the phase of the (DAC clock) ÷4 used to sample SYSREF± is stored in Register 0x037, Bits[7:0] and Register 0x038, Bits[3:0] as a thermometer code. This offset can be used by the SERDES data transmitter (for example, FPGA) to align multiple DACs by accounting for this clock offset when transmitting data. The sync modes are described below. See the Sync Procedure section for details on the procedure for syncing the LMFC signals.

#### One-Shot Sync Mode (SYNCMODE = Register 0x03A, Bits[1:0] = 0b10)

In one-shot sync mode, a phase check occurs on only the first alignment edge that is received after the sync machine is armed. After the phase is aligned on the first edge, the AD9161/AD9162 transition to monitor mode. Though an LMFC synchronization occurs only once, the SYSREF± signal can still be continuous. In this case, the phase is monitored and reported, but no clock phase adjustment occurs.

#### Continuous Sync Mode (SYNCMODE = Register 0x03A, Bits[1:0] = 0b01)

Continuous mode must be used in Subclass 1 only with a periodic SYSREF± signal. In continuous mode, a phase check/alignment occurs on every alignment edge.

Continuous mode differs from one-shot mode in two ways. First, no SPI cycle is required to arm the device; the alignment edge seen after continuous mode is enabled results in a phase check. Second, a phase check occurs on every alignment edge in continuous mode.

#### Monitor Sync Mode (SYNCMODE = Register 0x03A, Bits[1:0] = 0b00)

In monitor mode, the user can monitor the phase error in real time. Use this sync mode with a periodic SYSREF± signal. The phase is monitored and reported, but no clock phase adjustment occurs.

When an alignment request (SYSREF± edge) occurs, snapshots of the last phase error are placed into readable registers for reference (Register 0x037 and Register 0x038, Bits[3:0]), and the IRQ\_SYSREF\_JITTER interrupt is set, if appropriate.

### Sync Procedure

The procedure for enabling the sync is as follows:

1. Set up the DAC; the SERDES PLL locks it, and enables the CDR (see the Start-Up Sequence section).
2. Set Register 0x039 (SYSREF± jitter window). A minimum of 4 DAC clock cycles is recommended. See Table 23 for settings.
3. Optionally, read back the SYSREF± count to check whether the SYSREF± pulses are being received.
  - a. Set Register 0x036 = 0. Writing anything to SYSREF\_COUNT resets the count.
  - b. Set Register 0x034 = 0. Writing anything to SYNC\_LMFC\_STAT0 saves the data for readback and registers the count.
  - c. Read SYSREF\_COUNT from the value from Register 0x036.
4. Perform a one-shot sync.
  - a. Set Register 0x03A = 0x00. Clear one-shot mode if already enabled.
  - b. Set Register 0x03A = 0x02. Enable one-shot sync mode. The state machine enters monitor mode after a sync occurs.
5. Optionally, read back the sync SYNC\_LMFC\_STATx registers to verify that sync completed correctly.
  - a. Set Register 0x034 = 0. Register 0x034 must be written to read the value.
  - b. Read Register 0x035 and Register 0x034 to find the value of SYNC\_LMFC\_STATx. It is recommended to set SYNC\_LMFC\_STATx to 0 but it can be set to 4, or a LMFC period in DAC clocks – 4, due to jitter.
6. Optionally, read back the sync SYSREF\_PHASEx register to identify which phase of the divide by 4 was used to sample SYSREF±. Read Register 0x038 and Register 0x037 as thermometer code. The MSBs of Register 0x037, Bits[7:4], normally show the thermometer code value.
7. Turn the link on (Register 0x300, Bit 0 = 1).
8. Read back Register 0x302 (dynamic link latency).
9. Repeat the reestablishment of the link several times (Step 1 to Step 7) and note the dynamic link latency values. Based on the values, program the LMFC delay (Register 0x304) and the LMFC variable (Register 0x306), and then restart the link.

**Table 22. Sync Processing Modes**

| Sync Processing Mode | SYNC_MODE (Register 0x03A, Bits[1:0]) |
|----------------------|---------------------------------------|
| No synchronization   | 0b00                                  |
| One shot             | 0b10                                  |
| Continuous           | 0b01                                  |

**Table 23. SYSREF± Jitter Window Tolerance**

| SYSREF± Jitter Window Tolerance (DAC Clock Cycles) | SYSREF_JITTER_WINDOW (Register 0x039, Bits[5:0]) <sup>1</sup> |
|--|---|
| ±½   | 0x00  |
| ±4   | 0x04  |
| ±8   | 0x08  |
| ±12  | 0x0C  |
| ±16  | 0x10  |
| ±20  | 0x14  |
| +24  | 0x18  |
| ±28  | 0x1C  |

<sup>1</sup> The two least significant digits are ignored because the SYSREF± signal is sampled with a divide by 4 version of the DAC clock. As a result, the jitter window is set by this divide by 4 clock rather than the DAC clock. It is recommended that at least a four-DAC clock SYSREF± jitter window be chosen.

### Deterministic Latency

JESD204B systems contain various clock domains distributed throughout its system. Data traversing from one clock domain to a different clock domain can lead to ambiguous delays in the JESD204B link. These ambiguities lead to nonrepeatable latencies across the link from power cycle to power cycle with each new link establishment. Section 6 of the JESD204B specification addresses the issue of deterministic latency with mechanisms defined as Subclass 1 and Subclass 2.

The AD9161/AD9162 support JESD204B Subclass 0 and Subclass 1 operation, but not Subclass 2. Write the subclass to Register 0x458, Bits[7:5].

#### Subclass 0

This mode gives deterministic latency to within 32 DAC clock cycles. It does not require any signal on the SYSREF± pins, which can be left disconnected.

Subclass 0 still requires that all lanes arrive within the same LMFC cycle and the dual DACs must be synchronized to each other.

#### Subclass 1

This mode gives deterministic latency and allows the link to be synced to within four DAC clock periods. It requires an external SYSREF± signal that is accurately phase aligned to the DAC clock.

### Deterministic Latency Requirements

Several key factors are required for achieving deterministic latency in a JESD204B Subclass 1 system.

- SYSREF± signal distribution skew within the system must be less than the desired uncertainty.
- SYSREF± setup and hold time requirements must be met for each device in the system.
- The total latency variation across all lanes, links, and devices must be ≤10 PCLK periods, which includes both variable delays and the variation in fixed delays from lane to lane, link to link, and device to device in the system.

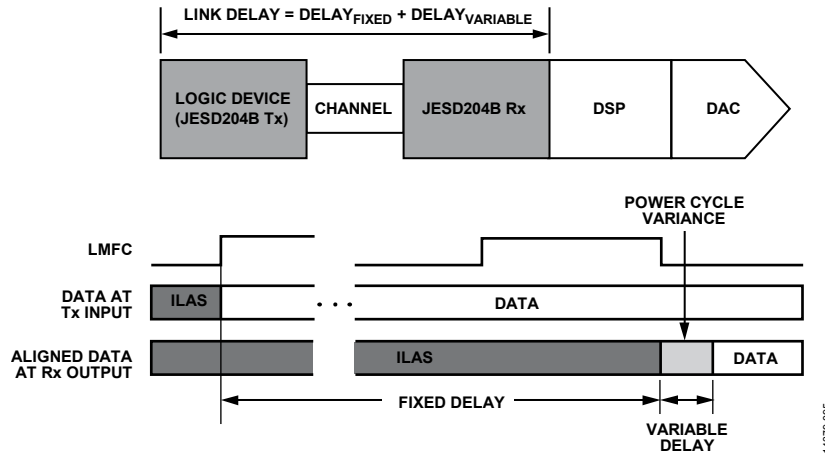

Figure 154. JESD204B Link Delay = Fixed Delay + Variable Delay

**Link Delay**

The link delay of a JESD204B system is the sum of the fixed and variable delays from the transmitter, channel, and receiver as shown in Figure 154.

For proper functioning, all lanes on a link must be read during the same LMFC period. Section 6.1 of the JESD204B specification states that the LMFC period must be larger than the maximum link delay. For the AD9161/AD9162, this is not necessarily the case; instead, the AD9161/AD9162 use a local LMFC for each link (LMFC<sub>Rx</sub>) that can be delayed from the SYSREF± aligned LMFC. Because the LMFC is periodic, this delay can account for any amount of fixed delay. As a result, the LMFC period must only be larger than the variation in the link delays, and the AD9161/AD9162 can achieve proper performance with a smaller total latency. Figure 155 and Figure 156 show a case where the link delay is greater than an LMFC period. Note that it can be accommodated by delaying LMFC<sub>Rx</sub>.

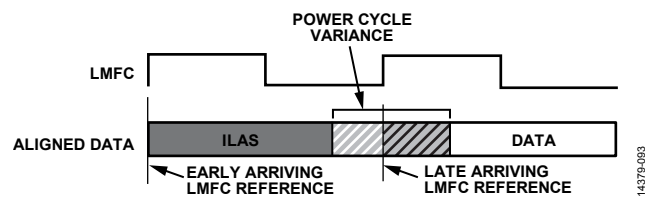

Figure 155. Link Delay > LMFC Period Example

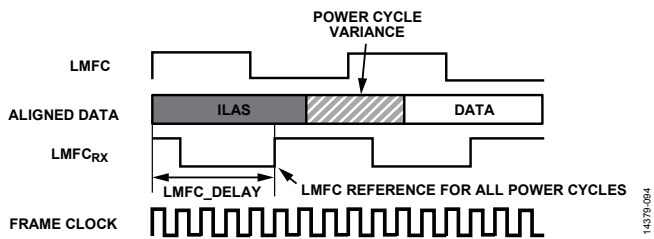

Figure 156. LMFC\_DELAY\_x to Compensate for Link Delay > LMFC

The method to select the LMFCDel (Register 0x304) and LMFCVar (Register 0x306) variables is described in the Link Delay Setup Example, With Known Delays section.

Setting LMFCDel appropriately ensures that all the corresponding data samples arrive in the same LMFC period. Then LMFCVar is written into the receive buffer delay (RBD) to absorb all link delay variation. This write ensures that all data samples have arrived before reading. By setting these to fixed values across runs and devices, deterministic latency is achieved.

The RBD described in the JESD204B specification takes values from 1 frame clock cycle to K frame clock cycles, and the RBD of the AD9161/AD9162 takes values from 0 PCLK cycle to 10 PCLK cycles. As a result, up to 10 PCLK cycles of total delay variation can be absorbed. LMFCVar and LMFCDel are both in PCLK cycles. The PCLK factor, or number of frame clock cycles per PCLK cycle, is equal to 4/F. For more information on this relationship, see the Clock Relationships section.

Two examples follow that show how to determine LMFCVar and LMFCDel. After they are calculated, write LMFCDel into Register 0x304 for all devices in the system, and write LMFCVar to Register 0x306 for all devices in the system.

**Link Delay Setup Example, With Known Delays**

All the known system delays can be used to calculate LMFCVar and LMFCDel.

The example shown in Figure 157 is demonstrated in the following steps. Note that this example is in Subclass 1 to achieve deterministic latency, which has a PCLK factor (4/F) of 2 frame clock cycles per PCLK cycle, and uses K = 32 (frames/multiframe). Because PCBFixed << PCLK Period, PCBFixed is negligible in this example and not included in the calculations.

1. Find the receiver delays using Table 7.
  - $RxFixed = 12$  PCLK cycles
  - $RxVar = 2$  PCLK cycles
2. Find the transmitter delays. The equivalent table in the example JESD204B core (implemented on a GTH or GTX gigabit transceiver on a Virtex-6 FPGA) states that the delay is  $56 \pm 2$  byte clock cycles.

3. Because the PCLK Rate = ByteRate/4 as described in the Clock Relationships section, the transmitter delays in PCLK cycles are calculated as follows:
 
$$TxFixed = 54/4 = 13.5 \text{ PCLK cycles}$$

$$TxVar = 4/4 = 1 \text{ PCLK cycle}$$
4. Calculate MinDelayLane as follows:
 
$$MinDelayLane = \text{floor}(RxFixed + TxFixed + PCBFixed)$$

$$= \text{floor}(12 + 13.5 + 0)$$

$$= \text{floor}(25.5)$$

$$MinDelayLane = 25$$
5. Calculate MaxDelayLane as follows:
 
$$MaxDelayLane = \text{ceiling}(RxFixed + RxVar + TxFixed + TxVar + PCBFixed)$$

$$= \text{ceiling}(12 + 2 + 13.5 + 1 + 0)$$

$$= \text{ceiling}(28.5)$$

$$MaxDelayLane = 29$$
6. Calculate LMFCVar as follows:
 
$$LMFCVar = (MaxDelay + 1) - (MinDelay - 1)$$

$$= (29 + 1) - (25 - 1) = 30 - 24$$

$$LMFCVar = 6 \text{ PCLK cycles}$$
7. Calculate LMFCDel as follows:
 
$$LMFCDel = (MinDelay - 1) \% (K/PCLKFactor)$$

$$= (25 - 1) \% (32/2)$$

$$= 24 \% 16$$

$$LMFCDel = 8 \text{ PCLK cycles}$$
8. Write LMFCDel to Register 0x304 for all devices in the system. Write LMFCVar to Register 0x306 for all devices in the system.

**Link Delay Setup Example, Without Known Delay**

If the system delays are not known, the AD9161/AD9162 can read back the link latency between LMFC<sub>Rx</sub> for each link and the SYSREF± aligned LMFC. This information is then used to calculate LMFCVar and LMFCDel.

Figure 159 shows how DYN\_LINK\_LATENCY\_0 (Register 0x302) provides a readback showing the delay (in PCLK cycles) between LMFC<sub>Rx</sub> and the transition from ILAS to the first data sample. By repeatedly power cycling and taking this measurement, the minimum and maximum delays across power cycles can be determined and used to calculate LMFCVar and LMFCDel.

In Figure 159, for Link A, Link B, and Link C, the system containing the AD9161/AD9162 (including the transmitter) is power cycled and configured 20 times. The AD9161/AD9162 are configured as described in the Sync Procedure section. Because the purpose of this exercise is to determine LMFCDel and LMFCVar, the LMFCDel value is programmed to 0 and the DYN\_LINK\_LATENCY\_0 value is read from Register 0x302. The variation in the link latency over the 20 runs is shown in Figure 159, described as follows:

- Link A gives readbacks of 6, 7, 0, and 1. Note that the set of recorded delay values rolls over the edge of a multiframe at the boundary of K/PCLK Factor = 8. Add the number of PCLK cycles per multiframe = 8 to the readback values of 0 and 1 because they rolled over the edge of the multiframe. Delay values range from 6 to 9.
- Link B gives delay values from 5 to 7.
- Link C gives delay values from 4 to 7.

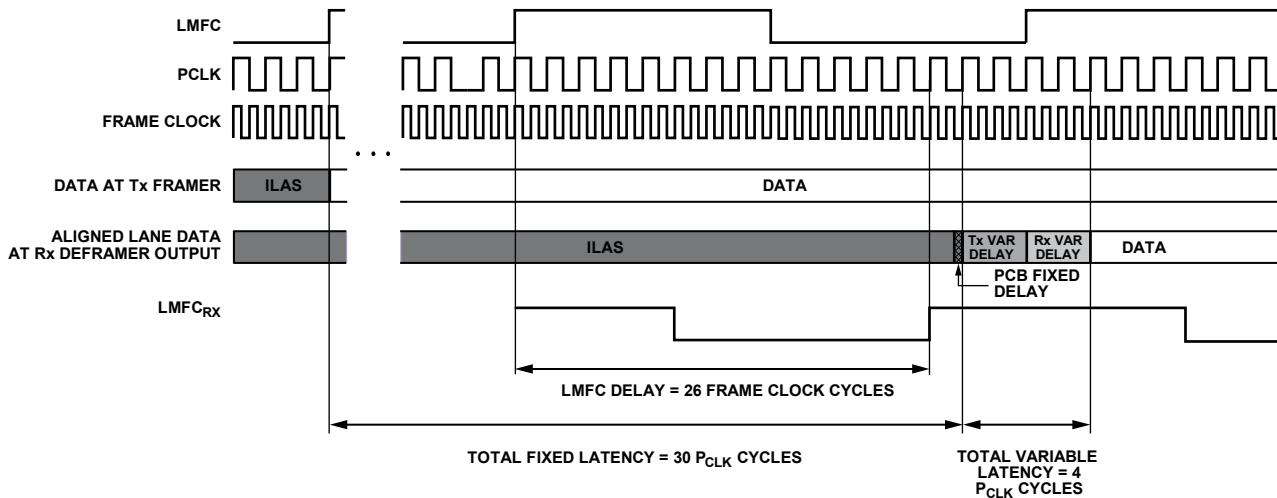

Figure 157. LMFC Delay Calculation Example

14379-006



The example shown in Figure 159 is demonstrated in the following steps. Note that this example is in Subclass 1 to achieve deterministic latency, which has a PCLK Factor (FrameRate ÷ PCLK Rate) of 2 and uses K = 16; therefore PCLKsPerMF = 8. This example is a hypothetical example used to illustrate the procedure, because K is always 32 on the AD9161/AD9162.

1. Calculate the minimum of all delay measurements across all power cycles, links, and devices as follows:  
 $MinDelay = \min(\text{all Delay values}) = 4$
2. Calculate the maximum of all delay measurements across all power cycles, links, and devices as follows:  
 $MaxDelay = \max(\text{all Delay values}) = 9$
3. Calculate the total delay variation (with guard band) across all power cycles, links, and devices as follows:  
 $LMFCVar = (MaxDelay + 1) - (MinDelay - 1)$   
 $= (9 + 1) - (4 - 1) = 10 - 3 = 7$  PCLK cycles

4. Calculate the minimum delay in PCLK cycles (with guard band) across all power cycles, links, and devices as follows:  
 $LMFCDel = ((MinDelay - 1) \times PCLK Factor) \% K$   
 $= ((4 - 1) \% 16) = (3) \% 16$   
 $= 3 \% 16 = 3$  PCLK cycles
5. Write LMFCDel to Register 0x304 for all devices in the system. Write LMFCVar to Register 0x306 for all devices in the system.

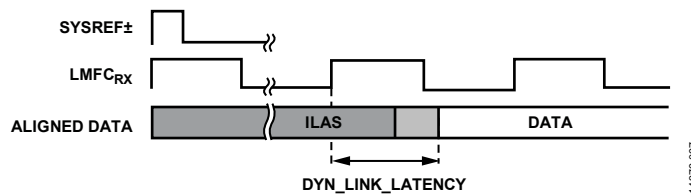

Figure 158. DYN\_LINK\_LATENCY\_x Illustration

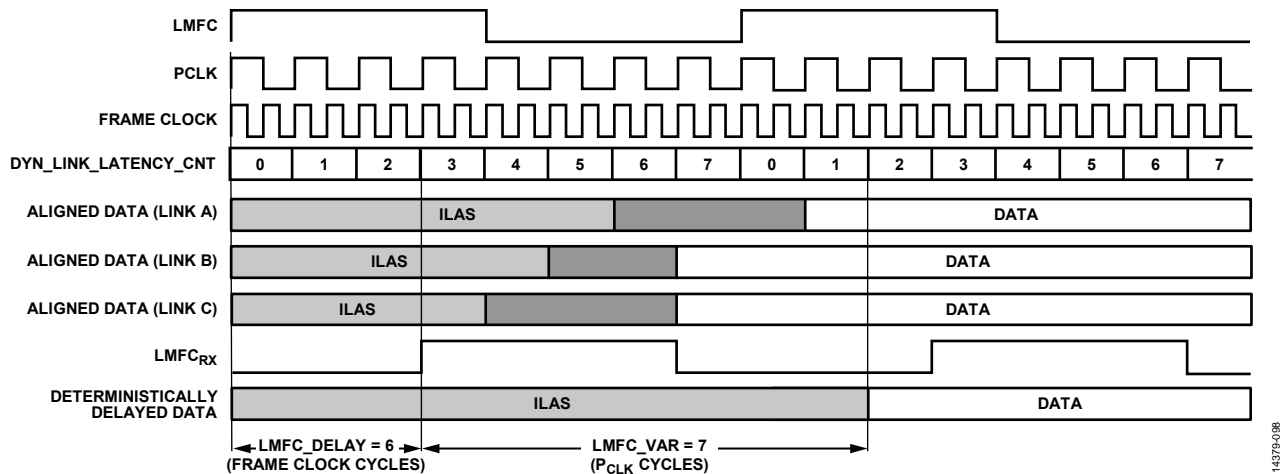

Figure 159. Multilink Synchronization Settings, Derived Method Example

TRANSPORT LAYER

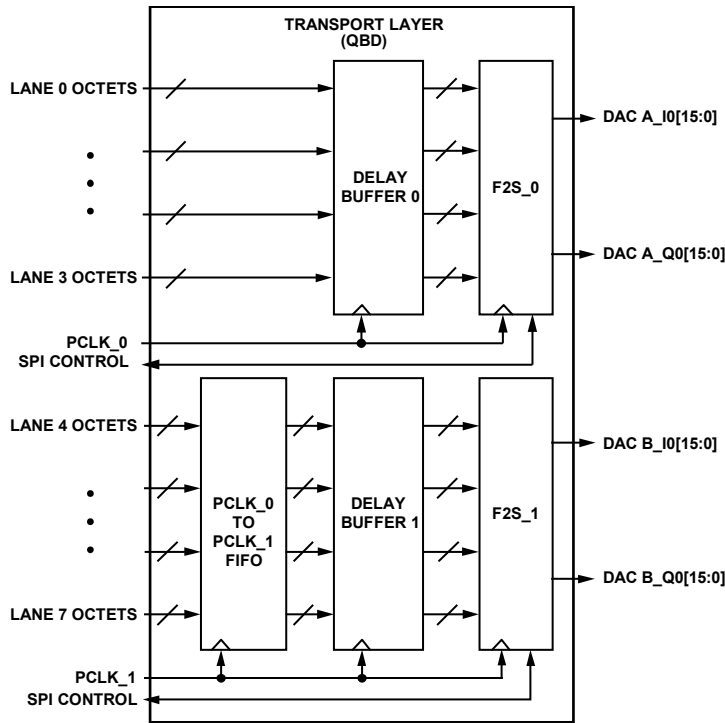

Figure 160. Transport Layer Block Diagram

The transport layer receives the descrambled JESD204B frames and converts them to DAC samples based on the programmed JESD204B parameters shown in Table 24. The device parameters are defined in Table 25.

Table 24. JESD204B Transport Layer Parameters

| Parameter | Description   |
|-----------|---|
| F         | Number of octets per frame per lane: 1, 2, or 4   |
| K         | Number of frames per multiframe: K = 32   |
| L         | Number of lanes per converter device (per link), as follows: 4, or 8                                  |
| M         | Number of converters per device (per link), as follows: 1 or 2 (2 is used for complex data interface) |
| S         | Number of samples per converter, per frame: 1 or 2  |

Table 25. JESD204B Device Parameters

| Parameter  | Description  |
|------------|--|
| CF         | Number of control words per device clock per link. Not supported, must be 0.   |
| CS         | Number of control bits per conversion sample. Not supported, must be 0.  |
| HD         | High density user data format. Used when samples must be split across lanes. Set to 1 always, even when F does not equal 1. Otherwise, a link configuration error triggers and the IRQ_ILAS flag is set. |
| N          | Converter resolution = 16.   |
| N' (or NP) | Total number of bits per sample = 16.  |

Certain combinations of these parameters are supported by the AD9161/AD9162. See Table 28 for a list of supported

interpolation rates and the number of lanes that is supported for each rate. Table 28 lists the JESD204B parameters for each of the interpolation and number of lanes configuration and gives an example lane rate for a 5 GHz DAC clock. Table 27 lists JESD204B parameters that have fixed values. A value of yes in Table 26 means the interpolation rate is supported for the number of lanes. A blank cell means it is not supported.

Table 26. Interpolation Rates and Number of Lanes

| Interpolation | 8                | 6                | 4   | 3                | 2   | 1   |
|---------------|------------------|------------------|-----|------------------|-----|-----|
| 1x            | Yes <sup>1</sup> |                  |     |                  |     |     |
| 2x            | Yes              | Yes <sup>1</sup> |     |                  |     |     |
| 3x            | Yes              | Yes              |     |                  |     |     |
| 4x            | Yes              | Yes              | Yes | Yes <sup>1</sup> |     |     |
| 6x            | Yes              | Yes              | Yes | Yes              |     |     |
| 8x            | Yes              | Yes              | Yes | Yes              | Yes |     |
| 12x           | Yes              | Yes              | Yes | Yes              | Yes |     |
| 16x           | Yes              | Yes              | Yes | Yes              | Yes | Yes |
| 24x           | Yes              | Yes              | Yes | Yes              | Yes | Yes |

<sup>1</sup> These modes restrict the maximum DAC clock rate to 5 GHz.

Table 27. JESD204B Parameters with Fixed Values

| Parameter | Value |
|-----------|-------|
| K         | 32    |
| N         | 16    |
| NP        | 16    |
| CF        | 0     |
| HD        | 1     |
| CS        | 0     |

Table 28. JESD204B Parameters for Interpolation Rate and Number of Lanes

| Interpolation Rate | No. of Lanes | M | F | S | PCLK Period (DAC Clocks) | LMFC Period (DAC Clocks) | Lane Rate at 5 GHz DAC Clock (GHz) |
|--------------------|--------------|---|---|---|--------------------------|--------------------------|------------------------------------|
| 1                  | 8            | 1 | 1 | 4 | 16                       | 128                      | 12.5                               |
| 2                  | 6            | 2 | 2 | 3 | 12                       | 192                      | 16.66 <sup>1</sup>                 |
| 2                  | 8            | 2 | 1 | 2 | 16                       | 128                      | 12.5                               |
| 3                  | 6            | 2 | 2 | 3 | 18                       | 288                      | 11.11                              |
| 3                  | 8            | 2 | 1 | 2 | 24                       | 192                      | 8.33                               |
| 4                  | 3            | 2 | 4 | 3 | 12                       | 384                      | 16.66 <sup>1</sup>                 |
| 4                  | 4            | 2 | 1 | 1 | 16                       | 128                      | 12.5                               |
| 4                  | 6            | 2 | 2 | 3 | 24                       | 384                      | 8.33                               |
| 4                  | 8            | 2 | 1 | 2 | 32                       | 256                      | 6.25                               |
| 6                  | 3            | 2 | 4 | 3 | 18                       | 576                      | 11.11                              |
| 6                  | 4            | 2 | 1 | 1 | 24                       | 192                      | 8.33                               |
| 6                  | 6            | 2 | 2 | 3 | 36                       | 576                      | 5.55                               |
| 6                  | 8            | 2 | 1 | 2 | 48                       | 384                      | 4.16                               |
| 8                  | 2            | 2 | 2 | 1 | 16                       | 256                      | 12.5                               |
| 8                  | 3            | 2 | 4 | 3 | 24                       | 768                      | 8.33                               |
| 8                  | 4            | 2 | 1 | 1 | 32                       | 256                      | 6.25                               |
| 8                  | 6            | 2 | 2 | 3 | 48                       | 768                      | 4.16                               |
| 8                  | 8            | 2 | 1 | 2 | 64                       | 512                      | 3.12                               |
| 12                 | 2            | 2 | 2 | 1 | 24                       | 384                      | 8.33                               |
| 12                 | 3            | 2 | 4 | 3 | 36                       | 1152                     | 5.55                               |
| 12                 | 4            | 2 | 1 | 1 | 48                       | 384                      | 4.16                               |
| 12                 | 6            | 2 | 2 | 3 | 72                       | 1152                     | 2.77                               |
| 12                 | 8            | 2 | 1 | 2 | 96                       | 768                      | 2.08                               |
| 16                 | 1            | 2 | 4 | 1 | 16                       | 512                      | 12.5                               |
| 16                 | 2            | 2 | 2 | 1 | 32                       | 512                      | 6.25                               |
| 16                 | 3            | 2 | 4 | 3 | 48                       | 1536                     | 4.16                               |
| 16                 | 4            | 2 | 1 | 1 | 64                       | 512                      | 3.12                               |
| 16                 | 6            | 2 | 2 | 3 | 96                       | 1536                     | 2.08                               |
| 16                 | 8            | 2 | 1 | 2 | 128                      | 1024                     | 1.56                               |
| 24                 | 1            | 2 | 4 | 1 | 24                       | 768                      | 8.33                               |
| 24                 | 2            | 2 | 2 | 1 | 48                       | 768                      | 4.16                               |
| 24                 | 3            | 2 | 4 | 3 | 72                       | 2304                     | 2.77                               |
| 24                 | 4            | 2 | 1 | 1 | 96                       | 768                      | 2.08                               |
| 24                 | 6            | 2 | 2 | 3 | 144                      | 2304                     | 1.38                               |
| 24                 | 8            | 2 | 1 | 2 | 192                      | 1536                     | 1.04                               |

<sup>1</sup> Maximum lane rate is 12.5 GHz. These modes must be run with the DAC rate below 3.75 GHz.

### Configuration Parameters

The AD9161/AD9162 modes refer to the link configuration parameters for L, K, M, N, NP, S, and F. Table 29 provides the description and addresses for these settings.

**Table 29. Configuration Parameters**

| JESD204B Setting | Description  | Address                   |
|------------------|--|---------------------------|
| L – 1            | Number of lanes – 1.   | Register 0x453, Bits[4:0] |
| F – 1            | Number of ((octets per frame) per lane) – 1.   | Register 0x454, Bits[7:0] |
| K – 1            | Number of frames per multiframe – 1.   | Register 0x455, Bits[4:0] |
| M – 1            | Number of converters – 1.  | Register 0x456, Bits[7:0] |
| N – 1            | Converter bit resolution – 1.  | Register 0x457, Bits[4:0] |
| NP – 1           | Bit packing per sample – 1.  | Register 0x458, Bits[4:0] |
| S – 1            | Number of ((samples per converter) per frame) – 1.   | Register 0x459, Bits[4:0] |
| HD               | High density format. Set to 1 always, even when F does not equal 1. Otherwise, a link configuration error triggers and the IRQ_ILAS flag is set. | Register 0x45A, Bit 7     |
| DID              | Device ID. Match the Device ID sent by the transmitter.  | Register 0x450, Bits[7:0] |
| BID              | Bank ID. Match the Bank ID sent by the transmitter.  | Register 0x451, Bits[7:0] |
| LID0             | Lane ID for Lane 0. Match the Lane ID sent by the transmitter on Logical Lane 0.   | Register 0x452, Bits[4:0] |
| JESDV            | JESD204x version. Match the version sent by the transmitter (0x0 = JESD204A, 0x1 = JESD204B).  | Register 0x459, Bits[7:5] |

### Data Flow Through the JESD204B Receiver

The link configuration parameters determine how the serial bits on the JESD204B receiver interface are deframed and passed on to the DACs as data samples.

### Deskewing and Enabling Logical Lanes

After proper configuration, the logical lanes are automatically deskewed. All logical lanes are enabled or not based on the lane number setting in Register 0x110, Bits[7:4]. The physical lanes are all powered up by default.

To disable power to physical lanes that are not being used, set Bit x in Register 0x201 to 1 to disable Physical Lane x, and keep it at 0 to enable it.

## JESD204B TEST MODES

### PHY PRBS Testing

The JESD204B receiver on the AD9161/AD9162 includes a PRBS pattern checker on the back end of its physical layer. This functionality enables bit error rate (BER) testing of each physical lane of the JESD204B link. The PHY PRBS pattern checker does not require that the JESD204B link be established. It

can synchronize with a PRBS7, PRBS15, or PRBS31 data pattern. PRBS pattern verification can be done on multiple lanes at once. The error counts for failing lanes are reported for one JESD204B lane at a time. The process for performing PRBS testing on the AD9161/AD9162 is as follows:

1. Start sending a PRBS7, PRBS15, or PRBS31 pattern from the JESD204B transmitter.
2. Select and write the appropriate PRBS pattern to Register 0x316, Bits[3:2], as shown in Table 30.
3. Enable the PHY test for all lanes being tested by writing to PHY\_TEST\_EN (Register 0x315). Each bit of Register 0x315 enables the PRBS test for the corresponding lane. For example, writing a 1 to Bit 0 enables the PRBS test for Physical Lane 0.
4. Toggle PHY\_TEST\_RESET (Register 0x316, Bit 0) from 0 to 1 then back to 0.
5. Set PHY\_PRBS\_TEST\_THRESHOLD\_xBITS (Bits[23:0], Register 0x319 to Register 0x317) as desired.
6. Write a 0 and then a 1 to PHY\_TEST\_START (Register 0x316, Bit 1). The rising edge of PHY\_TEST\_START starts the test.
  - a. (Optional) In some cases, it may be necessary to repeat Step 4 at this point. Toggle PHY\_TEST\_RESET (Register 0x316, Bit 0) from 0 to 1, then back to 0.
7. Wait 500 ms.
8. Stop the test by writing PHY\_TEST\_START (Register 0x316, Bit 1) = 0.
9. Read the PRBS test results.
  - a. Each bit of PHY\_PRBS\_PASS (Register 0x31D) corresponds to one SERDES lane (0 = fail, 1 = pass).
  - b. The number of PRBS errors seen on each failing lane can be read by writing the lane number to check (0 to 7) in PHY\_SRC\_ERR\_CNT (Register 0x316, Bits[6:4]) and reading the PHY\_PRBS\_ERR\_COUNT (Register 0x31C to Register 0x31A). The maximum error count is  $2^{24}-1$ . If all bits of Register 0x31C to Register 0x31A are high, the maximum error count on the selected lane is exceeded.

**Table 30. PHY PRBS Pattern Selection**

| PHY_PRBS_PAT_SEL Setting (Register 0x316, Bits[3:2]) | PRBS Pattern |
|--|--------------|
| 0b00 (default)                                       | PRBS7        |
| 0b01   | PRBS15       |
| 0b10   | PRBS31       |

### Transport Layer Testing

The JESD204B receiver in the AD9161/AD9162 supports the short transport layer (STPL) test as described in the JESD204B standard. This test can be used to verify the data mapping between the JESD204B transmitter and receiver. To perform this test, this function must be implemented in the logic device and enabled there. Before running the test on the receiver side, the link must be established and running without errors.

The STPL test ensures that each sample from each converter is mapped appropriately according to the number of converters (M) and the number of samples per converter (S). As specified in the JESD204B standard, the converter manufacturer specifies what test samples are transmitted. Each sample must have a unique value. For example, if M = 2 and S = 2, four unique samples are transmitted repeatedly until the test is stopped. The expected sample must be programmed into the device and the expected sample is compared to the received sample one sample at a time until all are tested. The process for performing this test on the [AD9161/AD9162](#) is described as follows:

1. Synchronize the JESD204B link.
2. Enable the STPL test at the JESD204B Tx.
3. Depending on JESD204B case, there may be up to two DACs, and each frame may contain up to four DAC samples. Configure the SHORT\_TPL\_REF\_SP\_MSB bits (Register 0x32E) and SHORT\_TPL\_REF\_SP\_LSB bits (Register 0x32D) to match one of the samples for one converter within one frame.
4. Set SHORT\_TPL\_SP\_SEL (Register 0x32C, Bits[7:4]) to select the sample within one frame for the selected converter according to Table 31.
5. Set SHORT\_TPL\_TEST\_EN (Register 0x32C, Bit 0) to 1.
6. Set SHORT\_TPL\_TEST\_RESET (Register 0x32C, Bit 1) to 1, then back to 0.
7. Wait for the desired time. The desired time is calculated as  $1/(\text{sample rate} \times \text{BER})$ . For example, given a bit error rate of  $\text{BER} = 1 \times 10^{-10}$  and a sample rate = 1 GSPS, the desired time = 10 sec.
8. Read the test result at SHORT\_TPL\_FAIL (Register 0x32F, Bit 0).
9. Choose another sample for the same or another converter to continue with the test, until all samples for both converters from one frame are verified. (Note that the converter count is M = 2 for all interpolator modes on the [AD9161/AD9162](#) to enable complex signal processing.)

Consult Table 31 for a guide to the test sample alignment. Note that the sample order for 1×, eight-lane mode has Sample 1 and Sample 2 swapped. Also, the STPL test for the three-lane and six-lane options is not functional and always fails.

**Table 31. Short TPL Test Samples Assignment<sup>1</sup>**

| JESD204x Mode  | Required Samples from JESD204x Tx                                | Samples Assignment   |
|--|--|--|
| 1× Eight-Lane (L = 8, M = 1, F = 1, S = 4)   | Send four samples: M0S0, M0S1, M0S2, M0S3, and repeat            | SP0: M0S0, SP4: M0S0, SP8: M0S0, SP12: M0S0<br>SP1: M0S2, SP5: M0S2, SP9: M0S2, SP13: M0S2<br>SP2: M0S1, SP6: M0S1, SP10: M0S1, SP14: M0S1<br>SP3: M0S3, SP7: M0S3, SP11: M0S3, SP15: M0S3 |
| 2× Eight-Lane (L = 8, M = 2, F = 1, S = 2)<br>3× Eight-Lane (L = 8, M = 2, F = 1, S = 2)<br>4× Eight-Lane (L = 8, M = 2, F = 1, S = 2)<br>6× Eight-Lane (L = 8, M = 2, F = 1, S = 2)<br>8× Eight-Lane (L = 8, M = 2, F = 1, S = 2)<br>12× Eight-Lane (L = 8, M = 2, F = 1, S = 2)<br>16× Eight-Lane (L = 8, M = 2, F = 1, S = 2)<br>24× Eight-Lane (L = 8, M = 2, F = 1, S = 2)  | Send four samples: M0S0, M0S1, M1S0, M1S1, and repeat            | SP0: M0S0, SP4: M0S0, SP8: M0S0, SP12: M0S0<br>SP1: M1S0, SP5: M1S0, SP9: M1S0, SP13: M1S0<br>SP2: M0S1, SP6: M0S1, SP10: M0S1, SP14: M0S1<br>SP3: M1S1, SP7: M1S1, SP11: M1S1, SP15: M1S1 |
| 2× Six-Lane (L = 6, M = 2, F = 2, S = 3)<br>3× Six-Lane (L = 6, M = 2, F = 2, S = 3)<br>4× Six-Lane (L = 6, M = 2, F = 2, S = 3)<br>6× Six-Lane (L = 6, M = 2, F = 2, S = 3)<br>8× Six-Lane (L = 6, M = 2, F = 2, S = 3)<br>12× Six-Lane (L = 6, M = 2, F = 2, S = 3)<br>16× Six-Lane (L = 6, M = 2, F = 2, S = 3)<br>24× Six-Lane (L = 6, M = 2, F = 2, S = 3)<br>4× Three-Lane (L = 3, M = 2, F = 4, S = 3)<br>6× Three-Lane (L = 3, M = 2, F = 4, S = 3)<br>8× Three-Lane (L = 3, M = 2, F = 4, S = 3)<br>12× Three-Lane (L = 3, M = 2, F = 4, S = 3)<br>16× Three-Lane (L = 3, M = 2, F = 4, S = 3)<br>24× Three-Lane (L = 3, M = 2, F = 4, S = 3) | Send six samples: M0S0, M0S1, M0S2, M1S0, M1S1, M1S2, and repeat | Test hardware is not functional; STPL always fails   |

| JESD204x Mode                              | Required Samples from JESD204x Tx    | Samples Assignment   |
|--|--------------------------------------|--|
| 4× Four-Lane (L = 4, M = 2, F = 1, S = 1)  | Send two samples: M0S0, M1S0, repeat | SP0: M0S0, SP4: M0S0, SP8: M0S0, SP12: M0S0<br>SP1: M1S0, SP5: M1S0, SP9: M1S0, SP13: M1S0<br>SP2: M0S0, SP6: M0S0, SP10: M0S0, SP14: M0S0<br>SP3: M1S0, SP7: M1S0, SP11: M1S0, SP15: M1S0 |
| 6× Four-Lane (L = 4, M = 2, F = 1, S = 1)  |                                      |  |
| 8× Four-Lane (L = 4, M = 2, F = 1, S = 1)  |                                      |  |
| 12× Four-Lane (L = 4, M = 2, F = 1, S = 1) |                                      |  |
| 16× Four-Lane (L = 4, M = 2, F = 1, S = 1) |                                      |  |
| 24× Four-Lane (L = 4, M = 2, F = 1, S = 1) |                                      |  |
| 8× Two-Lane (L = 2, M = 2, F = 2, S = 1)   |                                      |  |
| 12× Two-Lane (L = 2, M = 2, F = 2, S = 1)  |                                      |  |
| 16× Two-Lane (L = 2, M = 2, F = 2, S = 1)  |                                      |  |
| 24× Two-Lane (L = 2, M = 2, F = 2, S = 1)  |                                      |  |
| 16× One-Lane (L = 1, M = 2, F = 4, S = 1)  |                                      |  |
| 24× One-Lane (L = 1, M = 2, F = 4, S = 1)  |                                      |  |

<sup>1</sup> Mx is the converter number and Sy is the sample number. For example, M0S0 means Converter 0, Sample 0. SPx is the sample pattern word number. For example, SP0 means Sample Pattern Word 0.

### Repeated CGS and ILAS Test

As per Section 5.3.3.8.2 of the JESD204B specification, the [AD9161/AD9162](#) can check that a constant stream of /K28.5/ characters is being received, or that CGS followed by a constant stream of ILAS is being received.

To run a repeated CGS test, send a constant stream of /K28.5/ characters to the [AD9161/AD9162](#) SERDES inputs. Next, set up the device and enable the links. Ensure that the /K28.5/ characters are being received by verifying that SYNCOUT± is deasserted and that CGS has passed for all enabled link lanes by reading Register 0x470.

To run the CGS followed by a repeated ILAS sequence test, follow the procedure to set up the links, but before performing the last write (enabling the links), enable the ILAS test mode by writing a 1 to Register 0x477, Bit 7. Then, enable the links. When the device recognizes four CGS characters on each lane, it deasserts the SYNCOUT±. At this point, the transmitter starts sending a repeated ILAS sequence.

Read Register 0x473 to verify that initial lane synchronization has passed for all enabled link lanes.

### JESD204B ERROR MONITORING

#### Disparity, Not in Table, and Unexpected Control (K) Character Errors

As per Section 7.6 of the JESD204B specification, the [AD9161/AD9162](#) can detect disparity errors, not in table (NIT) errors, and unexpected control character errors, and can optionally issue a sync request and reinitialize the link when errors occur.

Note that the disparity error counter counts all characters with invalid disparity, regardless of whether they are in the 8-bit/10-bit decoding table. This is a minor deviation from the JESD204B specification, which only counts disparity errors when they are in the 8-bit/10-bit decoding table.

Several other interpretations of the JESD204B specification are noted in this section. When three NIT errors are injected to one lane and QUAL\_RDERR (Register 0x476, Bit 4) = 1, the readback values of the bad disparity error (BDE) count register is 1.

Reporting of disparity errors that occur at the same character position of an NIT error is disabled. No such disabling is performed for the disparity errors in the characters after an NIT error. Therefore, it is expected behavior that an NIT error may result in a BDE error.

A resync is triggered when four NIT errors are injected with Register 0x476, Bit 4 = 1. When this bit is set, the error counter does not distinguish between a concurrent invalid symbol with the wrong running disparity but is in the 8-bit/10-bit decoding table, and a NIT error. Thus, a resync can be triggered when four NIT errors are injected because they are not distinguished from disparity errors.

#### Checking Error Counts

The error count can be checked for disparity errors, NIT errors, and unexpected control character errors. The error counts are on a per lane and per error type basis. Each error type and lane has a register dedicated to it. To check the error count, the following steps must be performed:

1. Choose and enable which errors to monitor by selecting them in Register 0x480, Bits[5:3] to Register 0x487, Bits[5:3]. Unexpected K (UEK) character, BDE, and NIT error monitoring can be selected for each lane by writing a 1 to the appropriate bit, as described in the register map. These bits are enabled by default.
2. The corresponding error counter reset bits are in Register 0x480, Bits[2:0] to Register 0x487, Bits[2:0]. Write a 0 to the corresponding bit to reset that error counter.
3. Registers 0x488, Bits[2:0] to Register 0x48F, Bits[2:0] have the terminal count hold indicator for each error counter. If this flag is enabled, when the terminal error count of 0xFF is reached, the counter ceases counting and holds that value until reset. Otherwise, it wraps to 0x00 and continues counting. Select the desired behavior and program the corresponding register bits per lane.

### Check for Error Count Over Threshold

To check for the error count over threshold, follow these steps:

1. Define the error counter threshold. The error counter threshold can be set to a user defined value in Register 0x47C, or left to the default value of 0xFF. When the error threshold is reached, an IRQ is generated or SYNCOUT± is asserted or both, depending on the mask register settings. This one error threshold is used for all three types of errors (UEK, NIT, and BDE).
2. Set the SYNC\_ASSERT\_MASK bits. The SYNCOUT± assertion behavior is set in Register 0x47D, Bits[2:0]. By default, when any error counter of any lane is equal to the threshold, it asserts SYNCOUT± (Register 0x47D, Bits[2:0] = 0b111).
3. Read the error count reached indicator. Each error counter has a terminal count reached indicator, per lane. This indicator is set to 1 when the terminal count of an error counter for a particular lane has been reached. These status bits are located in Register 0x490, Bits[2:0] to Register 0x497, Bits[2:0]. These registers also indicate whether a particular lane is active by setting Bit 3 = 0b1.

### Error Counter and IRQ Control

For error counter and IRQ control, follow these steps:

1. Enable the interrupts. Enable the JESD204B interrupts. The interrupts for the UEK, NIT, and BDE error counters are in Register 0x4B8, Bits[7:5]. There are other interrupts to monitor when bringing up the link, such as lane deskewing, initial lane sync, good check sum, frame sync, code group sync (Register 0x4B8, Bits[4:0]), and configuration mismatch (Register 0x4B9, Bit 0). These bits are off by default but can be enabled by writing 0b1 to the corresponding bit.
  - a) Read the JESD204B interrupt status. The interrupt status bits are in Register 0x4BA, Bits[7:0] and Register 0x4BB, Bit 0, with the status bit position corresponding to the enable bit position.
2. It is recommended to enable all interrupts that are planned to be used prior to bringing up the JESD204B link. When the link is up, the interrupts can be reset and then used to monitor the link status.

### Monitoring Errors via SYNCOUT±

When one or more disparity, NIT, or unexpected control character errors occur, the error is reported on the SYNCOUT± pin as per Section 7.6 of the JESD204B specification. The JESD204B specification states that the SYNCOUT± signal is asserted for exactly two frame periods when an error occurs. For the AD9161/AD9162, the width of the SYNCOUT± pulse can be programmed to ½, 1, or 2 PCLK cycles. The settings to achieve a SYNCOUT± pulse of two frame clock cycles are given in Table 32.

Table 32. Setting SYNCOUT± Error Pulse Duration

| F | PCLK Factor (Frames/PCLK) | SYNC_ERR_DUR (Register 0x312, Bits[7:4]) Setting <sup>1</sup> |
|---|---------------------------|---|
| 1 | 4                         | 0 (default)   |
| 2 | 2                         | 1   |
| 4 | 1                         | 2   |

<sup>1</sup> These register settings assert the SYNCOUT± signal for two frame clock cycle pulse widths.

### Unexpected Control Character, NIT, Disparity IRQs

For UEK character, NIT, and disparity errors, error count over the threshold events are available as IRQ events. Enable these events by writing to Register 0x4B8, Bits[7:5]. The IRQ event status can be read at Register 0x4BA, Bits[7:5] after the IRQs are enabled.

See the Error Counter and IRQ Control section for information on resetting the IRQ. See the Interrupt Request Operation section for more information on IRQs.

### Errors Requiring Reinitializing

A link reinitialization automatically occurs when four invalid disparity characters are received as per Section 7.1 of the JESD204B specification. When a link reinitialization occurs, the resync request is five frames and nine octets long.

The user can optionally reinitialize the link when the error count for disparity errors, NIT errors, or UEK character errors reaches a programmable error threshold. The process to enable the reinitialization feature for certain error types is as follows:

1. Choose and enable which errors to monitor by selecting them in Register 0x480, Bits[5:3] to Register 0x487, Bits[5:3]. UEK, BDE, and NIT error monitoring can be selected for each lane by writing a 1 to the appropriate bit, as described in Table 46. These are enabled by default.
2. Enable the sync assertion mask for each type of error by writing to SYNC\_ASSERT\_MASK (Register 0x47D, Bits[2:0]) according to Table 33.
3. Program the desired error counter threshold into ERRORTHRES (Register 0x47C).
4. For each error type enabled in the SYNC\_ASSERT\_MASK register, if the error counter on any lane reaches the programmed threshold, SYNCOUT± falls, issuing a sync request. Note that all error counts are reset when a link reinitialization occurs. The IRQ does not reset and must be reset manually.

Table 33. Sync Assertion Mask (SYNC\_ASSERT\_MASK)

| Addr. | Bit No. | Bit Name | Description  |
|-------|---------|----------|--|
| 0x47D | 2       | BDE      | Set to 1 to assert SYNCOUT± if the disparity error count reaches the threshold     |
|       | 1       | NIT      | Set to 1 to assert SYNCOUT± if the NIT error count reaches the threshold           |
|       | 0       | UEK      | Set to 1 to assert SYNCOUT± if the UEK character error count reaches the threshold |

### CGS, Frame Sync, Checksum, and ILAS Monitoring

Register 0x470 to Register 0x473 can be monitored to verify that each stage of the JESD204B link establishment has occurred.

Bit x of CODE\_GRP\_SYNC (Register 0x470) is high if Link Lane x received at least four K28.5 characters and passed code group synchronization.

Bit x of FRAME\_SYNC (Register 0x471) is high if Link Lane x completed initial frame synchronization.

Bit x of GOOD\_CHECKSUM (Register 0x472) is high if the checksum sent over the lane matches the sum of the JESD204B parameters sent over the lane during ILAS for Link Lane x. The parameters can be added either by summing the individual fields in registers or summing the packed register. If Register 0x300, Bit 6 = 0 (default), the calculated checksums are the lower eight bits of the sum of the following fields: DID, BID, LID, SCR, L - 1, F - 1, K - 1, M - 1, N - 1, SUBCLASSV, NP - 1, JESDV, S - 1, and HD. If Register 0x300, Bit 6 = 1, the calculated checksums are the lower eight bits of the sum of Register 0x400 to Register 0x40C and LID.

Bit x of INIT\_LANE\_SYNC (Register 0x473) is high if Link Lane x passed the initial lane alignment sequence.

### CGS, Frame Sync, Checksum, and ILAS IRQs

Fail signals for CGS, frame sync, checksum, and ILAS are available as IRQ events. Enable them by writing to Register 0x4B8, Bits[3:0]. The IRQ event status can be read at Register 0x4BA, Bits[3:0] after the IRQs are enabled. Write a 1 to Register 0x4BA, Bit 0 to reset the CGS IRQ. Write a 1 to Register 0x4BA, Bit 1 to reset the frame sync IRQ. Write a 1 to Register 0x4BA, Bit 2 to reset the checksum IRQ. Write a 1 to Register 0x4BA, Bit 3 to reset the ILAS IRQ.

See the Interrupt Request Operation section for more information.

### Configuration Mismatch IRQ

The AD9161/AD9162 have a configuration mismatch flag that is available as an IRQ event. Use Register 0x4B9, Bit 0 to enable the mismatch flag (it is enabled by default), and then use Register 0x4BB, Bit 0 to read back its status and reset the IRQ signal. See the Interrupt Request Operation section for more information.

The configuration mismatch event flag is high when the link configuration settings (in Register 0x450 to Register 0x45D) do not match the JESD204B transmitted settings (Register 0x400 to Register 0x40D).

This function is different from the good checksum flags in Register 0x472. The good checksum flags ensure that the transmitted checksum matches a calculated checksum based on the transmitted settings. The configuration mismatch event ensures that the transmitted settings match the configured settings.

### HARDWARE CONSIDERATIONS

See the Applications Information section for information on hardware considerations.



## MAIN DIGITAL DATAPATH

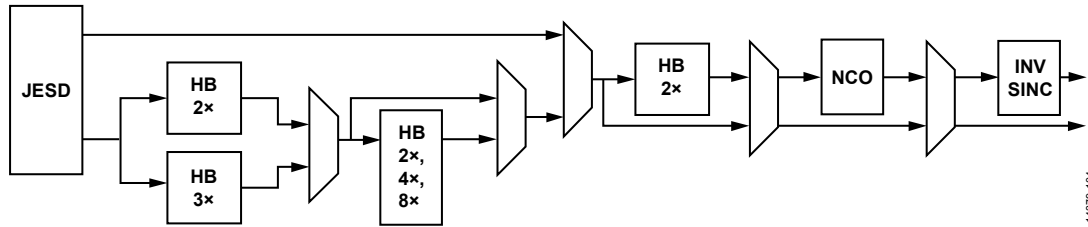

Figure 161. Block Diagram of the Main Digital Datapath

The block diagram in Figure 161 shows the functionality of the main digital datapath. The digital processing includes an input interpolation block with choice of bypass (1×), 2×, or 3× interpolation, three additional 2× half-band interpolation filters, a final 2× NRZ mode interpolator filter, FIR85, that can be bypassed, and a quadrature modulator that consists of a 48-bit NCO and an inverse sinc block.

All of the interpolation filters accept in-phase (I) and quadrature (Q) data streams as a complex data stream. Similarly, the quadrature modulator and inverse sinc function also accept input data as a complex data stream. Thus, any use of the digital datapath functions requires the input data to be a complex data stream.

In bypass mode (1× interpolation), the input data stream is expected to be real data.

Table 34. Pipeline Delay (Latency) for Various DAC Blocks

| Mode        | FIR85 On | Filter Bandwidth | Inverse Sinc | NCO | Pipeline Delay <sup>1</sup> (f <sub>DAC</sub> Clocks) |
|-------------|----------|------------------|--------------|-----|---|
| NCO only    | No       | N/A <sup>2</sup> | No           | Yes | 48  |
| 1× (Bypass) | No       | N/A <sup>2</sup> | No           | No  | 113   |
| 1× (Bypass) | No       | N/A <sup>2</sup> | Yes          | No  | 137   |
| 2×          | No       | 80%              | No           | No  | 155   |
| 2×          | No       | 90%              | No           | No  | 176   |
| 2×          | Yes      | 80%              | No           | No  | 202   |
| 2×          | No       | 80%              | Yes          | No  | 185   |
| 2×          | Yes      | 80%              | Yes          | No  | 239   |
| 2×          | Yes      | 80%              | Yes          | Yes | 279   |
| 3×          | No       | 80%              | No           | No  | 168   |
| 3×          | No       | 90%              | No           | No  | 202   |
| 4×          | No       | 80%              | No           | No  | 308   |
| 6×          | No       | 80%              | No           | No  | 332   |
| 8×          | No       | 80%              | No           | No  | 602   |
| 12×         | No       | 80%              | No           | No  | 674   |
| 16×         | No       | 80%              | No           | No  | 1188  |
| 24×         | No       | 80%              | No           | No  | 1272  |

<sup>1</sup> The pipeline delay given is a representative number and may vary by a cycle or two based on the internal handoff timing conditions at startup.

<sup>2</sup> N/A means not applicable.

The pipeline delay changes based on the digital datapath functions that are selected. See Table 34 for examples of the pipeline delay per block. These delays are in addition to the JESD204B latency.

### DATA FORMAT

The input data format for all modes on the AD9161/AD9162 is 16-bit, two's complement. The digital datapath and the DAC decoder operate in two's complement format.

To avoid the NCO frequency leakage, the digital codes fed into the DAC must be balanced around zero code (the number of positive codes must be equal to the number of negative codes). That is, input DC offset must be removed from the input digital code. If this offset is not removed from the input code, the leakage can become apparent when using the NCO to shift a signal that is above or below 0 Hz when synthesized. The NCO frequency is seen as a small spur at the NCO FTW.

### INTERPOLATION FILTERS

The main digital path contains five half-band interpolation filters, plus a final half-band interpolation filter that is used in 2× NRZ mode. The filters are cascaded as shown in Figure 161.

The first pair of filters is a 2× (HB2) or 3× (HB3) filter. Each of these filters has two options for bandwidth, 80% or 90%. The 80% filters are lower power than the 90%. The filters default to the lower power 80% bandwidth. To select the filter bandwidth as 90%, program the FILT\_BW bit in the DATAPATH\_CFG register to 1 (Register 0x111, Bit 4 = 0b1).

Following the first pair of filters is a series of 2× half-band filters, each of which halves the usable bandwidth of the previous one. HB4 has 45%, HB5 has 22.5%, and HB6 has 11.25% of the f<sub>DATA</sub> bandwidth.

The final half-band filter, FIR85, is used in the 2× NRZ mode. It is clocked at the 2 × f<sub>DAC</sub> rate and has a usable bandwidth of 45% of the f<sub>DAC</sub> rate. The FIR85 filter is a complex filter, and therefore the bandwidth is centered at 0 Hz. The FIR85 filter is used in conjunction with the complex interpolation modes to push the DAC update rate higher and move images further from the desired signal.

The FIR85 filter can be used with the 1× bypass mode, but in that mode, the signal is limited to the lower half of the Nyquist zone, that is, up to  $f_{DAC}/4$ . If the NCO is used with FIR85 in 1× bypass mode, images of the NCO upconversion appears because the data interface in 1× bypass is real; therefore, an image reject upconversion cannot be accomplished by the NCO. To synthesize a signal and then upconvert it with the NCO, use the complex data interface and choose an appropriate interpolator prior to FIR85.

Table 35 shows how to select each available interpolation mode, their usable bandwidths, and their maximum data rates. Calculate the available signal bandwidth as the interpolator filter bandwidth, BW, multiplied by  $f_{DAC}/\text{InterpolationFactor}$ , as follows:

$$BW_{SIGNAL} = BW_{FILT} \times (f_{DAC}/\text{InterpolationFactor})$$

**Filter Performance**

The interpolation filters interpolate between existing data in such a way that they minimize changes in the incoming data while suppressing the creation of interpolation images. This datapath is shown for each filter in Figure 162.

The usable bandwidth (as shown in Table 35) is defined as the frequency band over which the filters have a pass-band ripple of less than  $\pm 0.001$  dB and an image rejection of greater than 85 dB. A conceptual drawing that shows the relative bandwidth of each of the filters is shown in Figure 162. The maximum pass band amplitude of all filters is the same; they are different in the illustration to improve understanding.

**Table 35. Interpolation Modes and Usable Bandwidth**

| Interpolation Mode                 | INTERP_MODE, Register 0x110, Bits[3:0] | Available Signal Bandwidth (BW) <sup>1</sup> | Maximum $f_{DATA}$ (MHz)                               |
|------------------------------------|--|--|--|
| 1× (Bypass)                        | 0x00                                   | $f_{DAC}/2$                                  | $f_{DAC}^2$  |
| 2×                                 | 0x01                                   | $BW \times f_{DATA}/2$                       | $f_{DAC}/2^2$  |
| 3×                                 | 0x02                                   | $BW \times f_{DATA}/2$                       | $f_{DAC}/3$  |
| 4×                                 | 0x03                                   | $BW \times f_{DATA}/2$                       | $f_{DAC}/4$  |
| 6×                                 | 0x04                                   | $BW \times f_{DATA}/2$                       | $f_{DAC}/6$  |
| 8×                                 | 0x05                                   | $BW \times f_{DATA}/2$                       | $f_{DAC}/8$  |
| 12×                                | 0x06                                   | $BW \times f_{DATA}/2$                       | $f_{DAC}/12$   |
| 16×                                | 0x07                                   | $BW \times f_{DATA}/2$                       | $f_{DAC}/16$   |
| 24×                                | 0x08                                   | $BW \times f_{DATA}/2$                       | $f_{DAC}/24$   |
| 2× NRZ (Register 0x111, Bit 0 = 1) | Any combination <sup>3</sup>           | $0.45 \times f_{DAC}$ <sup>4</sup>           | $f_{DAC}$ (real) or $f_{DAC}/2$ (complex) <sup>2</sup> |

<sup>1</sup> The data rate ( $f_{DATA}$ ) for all interpolator modes is a complex data rate, meaning each of I data and Q data run at that rate. The data rate for the 1× bypass mode is a real data rate. Available signal bandwidth is the data rate multiplied by the bandwidth of the initial 2× or 3× interpolator filters, which can be set to  $BW = 80\%$  or  $BW = 90\%$ . This bandwidth is centered at 0 Hz.

<sup>2</sup> The maximum speed for 1× and 2× interpolation is limited by the JESD204B interface, and is 5000 MHz (real) in 1× or 2500 MHz (complex) in 2× interpolation mode.

<sup>3</sup> The 2× NRZ filter, FIR85, can be used with any of the interpolator combinations. When used in 1× bypass mode, the desired signal must be placed in the lower half of the first Nyquist zone, as in 0 to  $DAC\ clock \div 4$  MHz.

<sup>4</sup> The bandwidth of the FIR85 filter is centered at 0 Hz.

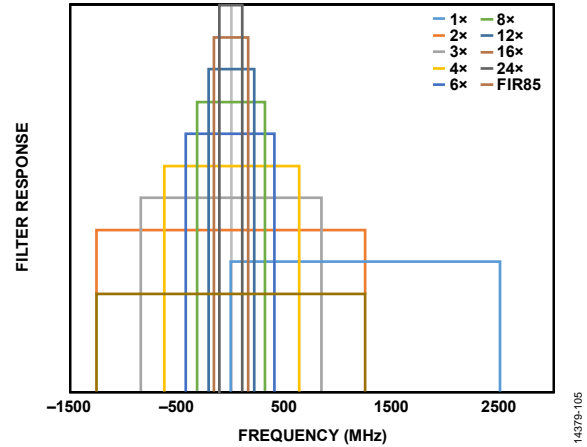

Figure 162. All Band Responses of Interpolation Filters

**Filter Performance Beyond Specified Bandwidth**

Some of the interpolation filters are specified to  $0.4 \times f_{DATA}$  (with a pass band). The filters can be used slightly beyond this ratio at the expense of increased pass-band ripple and decreased interpolation image rejection.

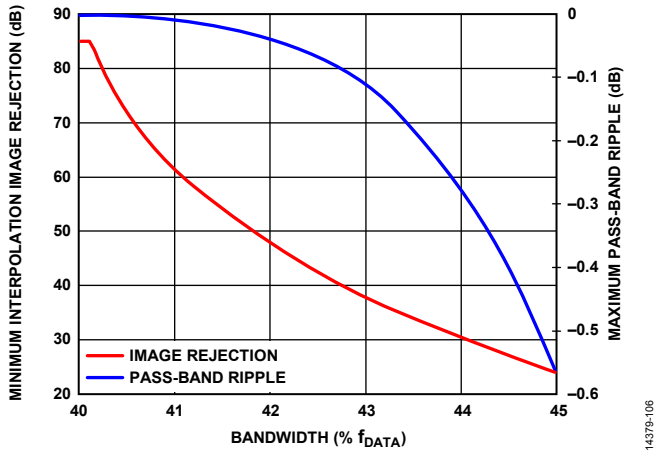

Figure 163. Interpolation Filter Performance Beyond Specified Bandwidth for the 80% Filters

Figure 163 shows the performance of the interpolation filters beyond  $0.4 \times f_{DATA}$ . The ripple increases much slower than the image rejection decreases. This means that if the application can tolerate degraded image rejection from the interpolation filters, more bandwidth can be used.

Most of the filters are specified to  $0.45 \times f_{DATA}$  (with pass band). Figure 164 to Figure 171 show the filter response for each of the interpolator filters on the AD9161/AD9162.

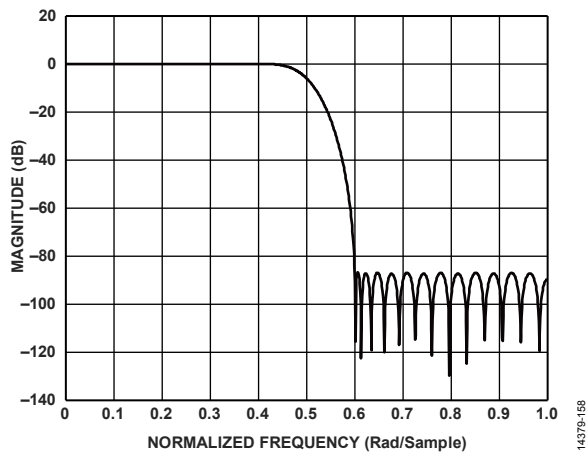

Figure 164. First 2x Half-Band 80% Filter Response

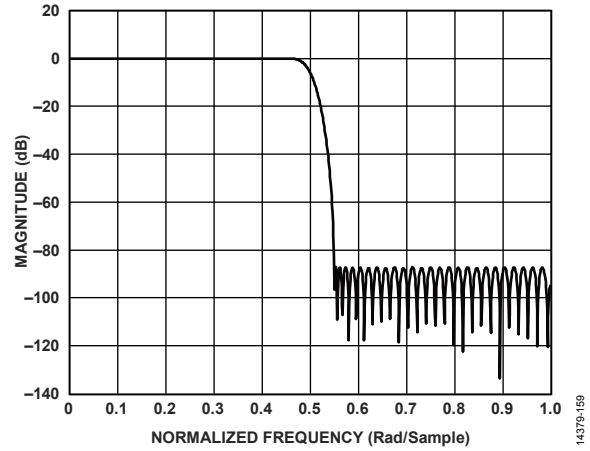

Figure 165. First 2x Half-Band 90% Filter Response

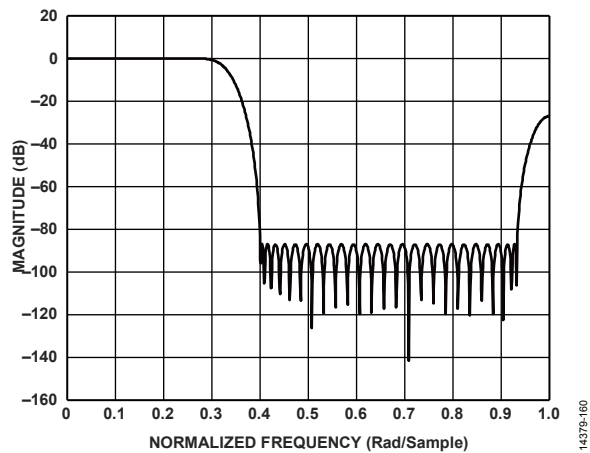

Figure 166. 3x Third-Band 80% Filter Response

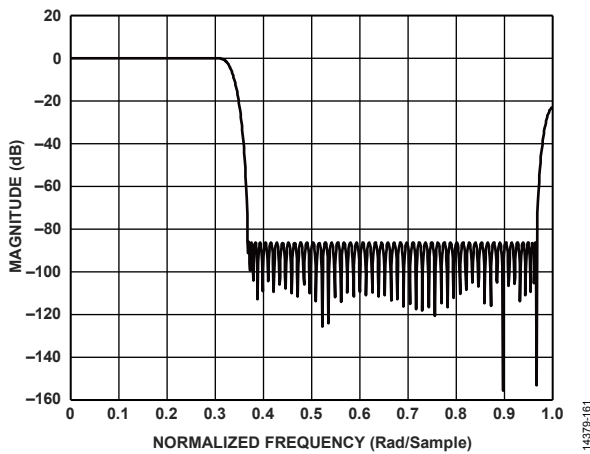

Figure 167. 3x Third-Band 90% Filter Response

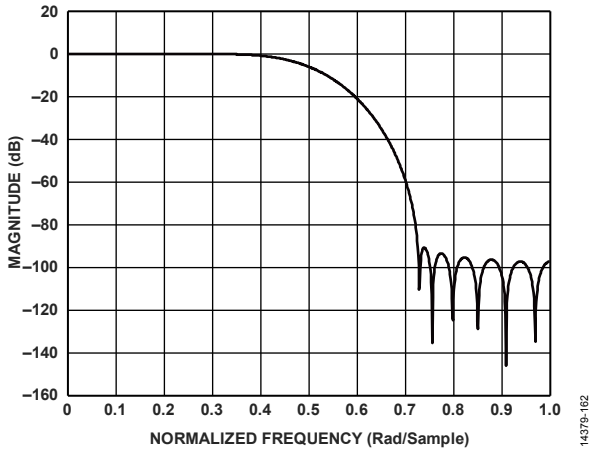

Figure 168. Second 2x Half-Band 45% Filter Response

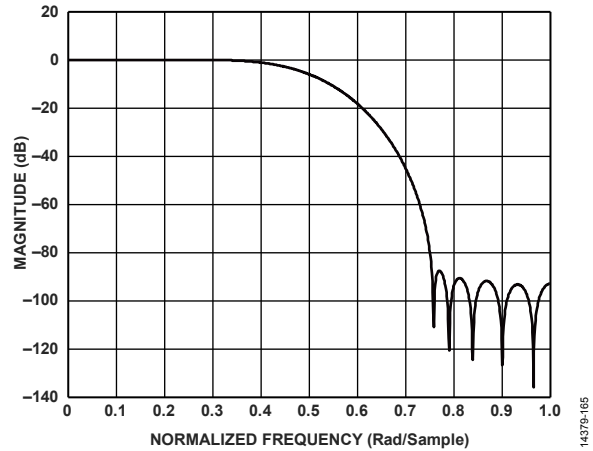

Figure 171. FIR85 2x Half-Band 45% Filter Response

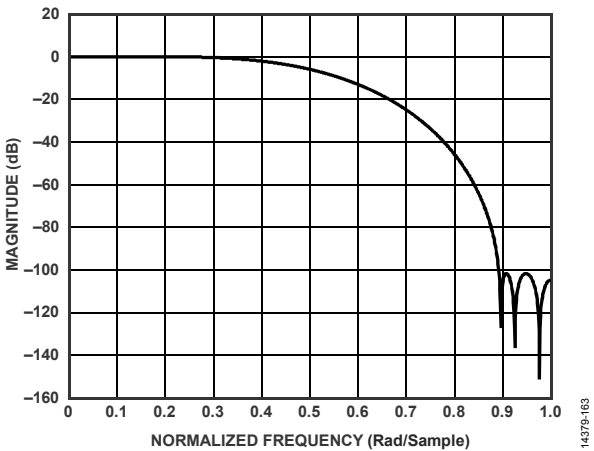

Figure 169. Third 2x Half-Band 22.5% Filter Response

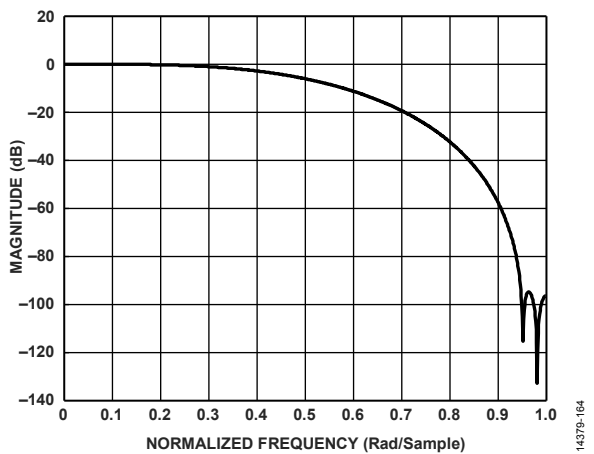

Figure 170. Fourth 2x Half-Band 11.25% Filter Response

**DIGITAL MODULATION**

The AD9161/AD9162 have digital modulation features to modulate the baseband quadrature signal to the desired DAC output frequency.

The AD9161/AD9162 are equipped with several NCO modes. The default NCO is a 48-bit, integer NCO. The A/B ratio of the dual modulus NCO allows the output frequency to be synthesized with very fine precision. NCO mode is selected as shown in Table 36.

Table 36. Modulation Mode Selection

| Modulation Mode         | Modulation Type       |                       |
|-------------------------|-----------------------|-----------------------|
|                         | Register 0x111, Bit 6 | Register 0x111, Bit 2 |
| None                    | 0b0                   | 0b0                   |
| 48-Bit Integer NCO      | 0b1                   | 0b0                   |
| 48-Bit Dual Modulus NCO | 0b1                   | 0b1                   |

**48-Bit Dual Modulus NCO**

This modulation mode uses an NCO, a phase shifter, and a complex modulator to modulate the signal by a programmable carrier signal as shown in Figure 172. This configuration allows output signals to be placed anywhere in the output spectrum with very fine frequency resolution.

The NCO produces a quadrature carrier to translate the input signal to a new center frequency. A quadrature carrier is a pair of sinusoidal waveforms of the same frequency, offset 90° from each other. The frequency of the quadrature carrier is set via a FTW. The quadrature carrier is mixed with the I and Q data and then summed into the I and Q datapaths, as shown in Figure 172.

**Integer NCO Mode**

The main 48-bit NCO can be used as an integer NCO by using the following formula to create the frequency tuning word (FTW):

$$-f_{DAC}/2 \leq f_{CARRIER} < +f_{DAC}/2$$

$$FTW = (f_{CARRIER}/f_{DAC}) \times 2^{48}$$

where *FTW* is a 48-bit, twos complement number.

When in 2× NRZ mode (FIR85 enabled with Register 0x111, Bit 0 = 1), the frequency tuning word is calculated as

$$0 \leq f_{CARRIER} < f_{DAC}$$

$$FTW = (f_{CARRIER}/f_{DAC}) \times 2^{48}$$

where *FTW* is a 48-bit binary number.

This method of calculation causes  $f_{CARRIER}$  values in the second Nyquist zone to appear to move to  $f_{DAC} - f_{CARRIER}$  when flipping the FIR85 enable bit and not changing the FTW to account for the change in number format.

The intended effect is that a sweep of the NCO from 0 Hz to  $f_{DAC} - f_{DAC}/2^{48}$  appears seamless when the FIR85 enable bit is set to Register 0x111, Bit 0 = 0b1 prior to  $f_{CARRIER}/f_{DAC} = 0.5$ . As can be seen from examination, the FTWs from 0 to less than  $f_{DAC}/2$  mean the same in either case, but they mean different  $f_{CARRIER}$  values from  $f_{DAC}/2$  to  $f_{DAC} - f_{DAC}/2^{48}$ . This effect must be considered when constructing FTW values and using the 2× NRZ mode.

The frequency tuning word is set as shown in Table 37.

**Table 37. NCO FTW Registers**

| Address | Value      | Description        |
|---------|------------|--------------------|
| 0x114   | FTW[7:0]   | 8 LSBs of FTW      |
| 0x115   | FTW[15:8]  | Next 8 bits of FTW |
| 0x116   | FTW[23:16] | Next 8 bits of FTW |
| 0x117   | FTW[31:24] | Next 8 bits of FTW |
| 0x118   | FTW[39:32] | Next 8 bits of FTW |
| 0x119   | FTW[47:40] | 8 MSBs of FTW      |

Unlike other registers, the FTW registers are not updated immediately upon writing. Instead, the FTW registers update on the rising edge of FTW\_LOAD\_REQ (Register 0x113, Bit 0). After an update request, FTW\_LOAD\_ACK (Register 0x113, Bit 1) must be high to acknowledge that the FTW has updated.

The SEL\_SIDE BAND bit (Register 0x111, Bit 1 = 0b1) is a convenience bit that can be set to use the lower sideband modulation result, which is equivalent to flipping the sign of the FTW.

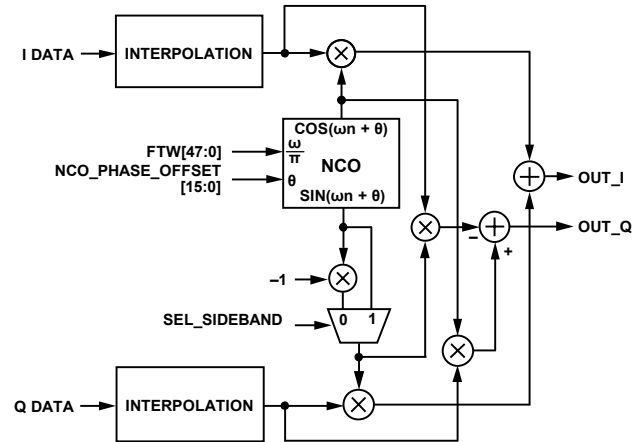

Figure 172. NCO Modulator Block Diagram

**Modulus NCO Mode**

The main 48-bit NCO can also be used in a dual modulus mode to create fractional frequencies beyond the 48-bit accuracy. The modulus mode is enabled by programming the MODULUS\_EN bit in the DATAPATH\_CFG register to 1 (Register 0x111, Bit 2 = 0b1).

The frequency ratio for the programmable modulus direct digital synthesis (DDS) is very similar to that of the typical accumulator-based DDS. The only difference is that N is not required to be a power of two for the programmable modulus, but can be an arbitrary integer. In practice, hardware constraints place limits on the range of values for N. As a result, the modulus extends the use of the NCO to applications that require exact rational frequency synthesis. The underlying function of the programmable modulus technique is to alter the accumulator modulus.

Implementation of the programmable modulus function within the AD9161/AD9162 is such that the fraction, M/N, is expressible per Equation 1. Note that the form of the equation implies a compound frequency tuning word with X representing the integer part and A/B representing the fractional part.

$$\frac{f_{CARRIER}}{f_{DAC}} = \frac{M}{N} = \frac{X + \frac{A}{B}}{2^{48}} \tag{1}$$

where:

X is programmed in Register 0x114 to Register 0x119.  
 A is programmed in Register 0x12A to Register 0x12F.  
 B is programmed in Register 0x124 to Register 0x129.

### Programmable Modulus Example

Consider the case in which  $f_{DAC} = 2500$  MHz and the desired value of  $f_{CARRIER}$  is 250 MHz. This scenario synthesizes an output frequency that is not a power of two submultiple of the sample rate, namely  $f_{CARRIER} = (1/10) f_{DAC}$ , which is not possible with a typical accumulator-based DDS. The frequency ratio,  $f_{CARRIER}/f_{DAC}$ , leads directly to M and N, which are determined by reducing the fraction (250,000,000/2,500,000,000) to its lowest terms, that is,

$$M/N = 250,000,000/2,500,000,000 = 1/10$$

Therefore,  $M = 1$  and  $N = 10$ .

After calculation,  $X = 28147497671065$ ,  $A = 3$ , and  $B = 5$ . Programming these values into the registers for X, A, and B (X is programmed in Register 0x114 to Register 0x119, B is programmed in Register 0x124 to Register 0x129, and A is programmed in Register 0x12A to Register 0x12F) causes the NCO to produce an output frequency of exactly 250 MHz given a 2500 MHz sampling clock. For more details, refer to the [AN-953 Application Note](#) on the Analog Devices, Inc., website.

### NCO Reset

Resetting the NCO can be useful when determining the start time and phase of the NCO. The NCO can be reset by several different methods, including a SPI write, using the TX\_ENABLE pin, or by the SYSREF± signal. Due to internal timing variations from device to device, these methods achieve an accuracy of ±6 DAC clock cycles.

Program Register 0x800, Bits[7:6] to 0b01 to set the NCO in phase discontinuous switching mode via a write to the SPI port. Then, any time the frequency tuning word is updated, the NCO phase accumulator resets and the NCO begins counting at the new FTW.

### Changing the Main NCO Frequency

In the main 48-bit NCO, the mode of updating the frequency tuning word can be changed from requiring a write to the FTW\_LOAD\_REQ bit (Register 0x113, Bit 0) to an automatic update mode. In the automatic update mode, the FTW is updated as soon as the chosen FTW word is written.

To set the automatic FTW update mode, write the appropriate word to the FTW\_REQ\_MODE bits (Register 0x113, Bits[6:4]), choosing the particular FTW word that causes the automatic update. For example, if relatively coarse frequency steps are needed, it may be sufficient to write a single word to the MSB byte of the FTW, and therefore the FTW\_REQ\_MODE bits can be programmed to 110 (Register 0x113, Bits[6:4] = 0b110). Then, each time the most significant byte, FTW5, is written, the NCO FTW is automatically updated.

The FTW\_REQ\_MODE bits can be configured to use any of the FTW words as the automatic update trigger word. This configuration provides convenience when choosing the order in which to program the FTW registers.

The speed of the SPI port write function is guaranteed and is a minimum of 100 MHz (see Table 4). Thus, the NCO FTW can be updated in as little as 240 ns with a one register write in automatic update mode.

The NCO only supports phase noncontinuous mode. In this mode, the phase accumulator is reset by updating the frequency tuning word of the NCO, making an instantaneous jump to the new frequency.

### INVERSE SINC

The AD9161/AD9162 provide a digital inverse sinc filter to compensate the DAC roll-off over frequency. The filter is enabled by setting the INVSINC\_ENABLE bit (Register 0x111, Bit 7) and is disabled by default.

The inverse sinc ( $\text{sinc}^{-1}$ ) filter is a seven-tap FIR filter. Figure 173 shows the frequency response of  $\text{sin}(x)/x$  roll-off, the inverse sinc filter, and the composite response. The composite response has less than ±0.05 dB pass-band ripple up to a frequency of  $0.4 \times f_{DACCLK}$ . When 2× NRZ mode is enabled, the inverse sinc filter operates to  $0.4 \times f_{2 \times DACCLK}$ . To provide the necessary peaking at the upper end of the pass band, the inverse sinc filter shown has an intrinsic insertion loss of about 3.8 dB.

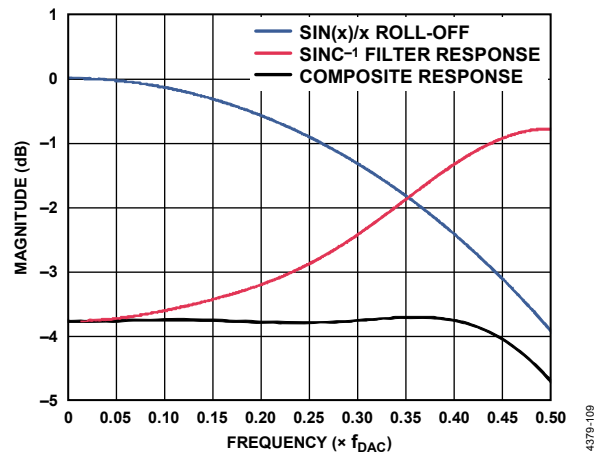

Figure 173. Responses of  $\text{Sin}(x)/x$  Roll-Off, the  $\text{Sinc}^{-1}$  Filter, and the Composite of the Two

### DOWNSTREAM PROTECTION

The AD9161/AD9162 have several features designed to protect the power amplifier (PA) of the system, as well as other downstream blocks. They consist of a control signal from the LMFC sync logic and a transmit enable function. The protection mechanism in each case is the blanking of data that is passed to the DAC decoder. The differences lie in the location in the datapath and slight variations of functionality.

The JESD204B serial link has several flags and quality measures to indicate the serial link is up and running error free. If any of these measures flags an issue, a signal from the LMFC sync logic is sent to a mux that stops data from flowing to the DAC decoder and replaces it with 0s.

There are several transmit enable features, including a TX\_ENABLE register that can be used to squelch data at several points in the datapath or configure the TX\_ENABLE pin to do likewise.

### Transmit Enable

The transmit enable feature can be configured either as a SPI controlled function or a pin controlled function. It can be used for several different purposes. The SPI controlled function has less accurate timing due to its reliance on a microcontroller to program it; therefore, it is typically used as a preventative measure at power-up or when configuring the device.

The SPI controlled TX\_ENABLE function can be used to zero the input to the digital datapath or to zero the output from the digital datapath, as shown in Figure 174. If the input to the digital datapath is zeroed, any filtering that is selected filters the 0 signal, causing a gradual ramp-down of energy in the digital datapath. If the digital datapath is bypassed, as in 1÷ mode, the data at the input to the DAC immediately drops to zero.

The TX\_ENABLE pin can be used for more accurate timing when enabling or disabling the DAC output. The effect of the TX\_ENABLE pin can be configured by the same TX\_ENABLE register (Register 0x03F) as is used for the SPI controlled functions, and it can be made to have the same effects as the SPI controlled function, namely to zero the input to the digital datapath or to zero the output from the digital datapath. In addition, the TX\_ENABLE pin can also be configured to ramp down (or up) the full-scale current of the DAC. The ramp down reduces the output power of the DAC by about 20 dB from full scale to the minimum output current.

The TX\_ENABLE pin can also be programmed to reset the NCO phase accumulator. See Table 38 for a description of the settings available for the TX\_ENABLE function.

### DATAPATH PRBS

The datapath PRBS can verify that the AD9161/AD9162 datapaths receive and correctly decode data. The datapath PRBS verifies that the JESD204B parameters of the transmitter and receiver match, the lanes of the receiver are mapped appropriately, the lanes

are appropriately inverted, and, if necessary, the start-up routine is correctly implemented.

To run the datapath PRBS test, complete the following steps:

1. Set up the device in the desired operating mode using the start-up sequence.
2. Send PRBS7 or PRBS15 data.
3. Write Register 0x14, Bit 2 = 0 for PRBS7 or 1 for PRBS15.
4. Write Register 0x14B, Bits[1:0] = 0b11 to enable and reset the PRBS test.
5. Write Register 0x14B, Bits[1:0] = 0b01 to enable the PRBS test and release reset.
6. Wait 500 ms.
7. Check the status of the PRBS by checking the IRQ for the I and Q path PRBS as described in the Datapath PRBS IRQ section.
8. Read Register 0x14B, Bits [7:6]. Bit 6 is 0 if the I channel has any errors. Bit 7 is 0 if the Q channel has any errors.
9. Read Register 0x14C to read the error count for the I channel.
10. Read Register 0x14D to read the error count for the Q channel. The PRBS processes 32 bits at a time and compares the 32 new bits to the previous set of 32 bits. It detects and reports only one error in every group of 32 bits; therefore, the error count partly depends on when the errors are seen.

For example, see the following sequence:

- Bits: 32 good, 31 good, 1 bad; 32 good [2 errors]
- Bits: 32 good, 22 good, 10 bad; 32 good [2 errors]
- Bits: 32 good, 31 good, 1 bad; 31 good, 1 bad; 32 good [3 errors]

### DATAPATH PRBS IRQ

The PRBS fail signals for the I and Q path are available as IRQ events. Use Register 0x020, Bits [1:0] to enable the fail signals, and then use Register 0x024, Bits [1:0] to read back the status and reset the IRQ signals. See the Interrupt Request Operation section for more information.

**Table 38. TX\_ENABLE Settings**

| Register 0x03F | Setting          | Description   |
|----------------|------------------|---|
| Bit 7          | 0                | SPI control: zero data to the DAC                         |
|                | 1                | SPI control: allow data to pass to the DAC                |
| Bit 6          | 0                | SPI control: zero data at input to the datapath           |
|                | 1                | SPI control: allow data to enter the datapath             |
| Bits[5:4]      | N/A <sup>1</sup> | Reserved  |
| Bit 3          | 0                | Use SPI writes to reset the NCO <sup>2</sup>              |
|                | 1                | Use TX_ENABLE to reset the NCO                            |
| Bit 2          | 0                | Use SPI control to zero data to the DAC                   |
|                | 1                | Use TX_ENABLE pin to zero data to the DAC                 |
| Bit 1          | 0                | Use SPI control to zero data at the input to the datapath |
|                | 1                | Use TX_ENABLE pin to zero data at input to the datapath   |
| Bit 0          | 0                | Use SPI registers to control the full-scale current       |
|                | 1                | Use TX_ENABLE pin to control the full-scale current       |

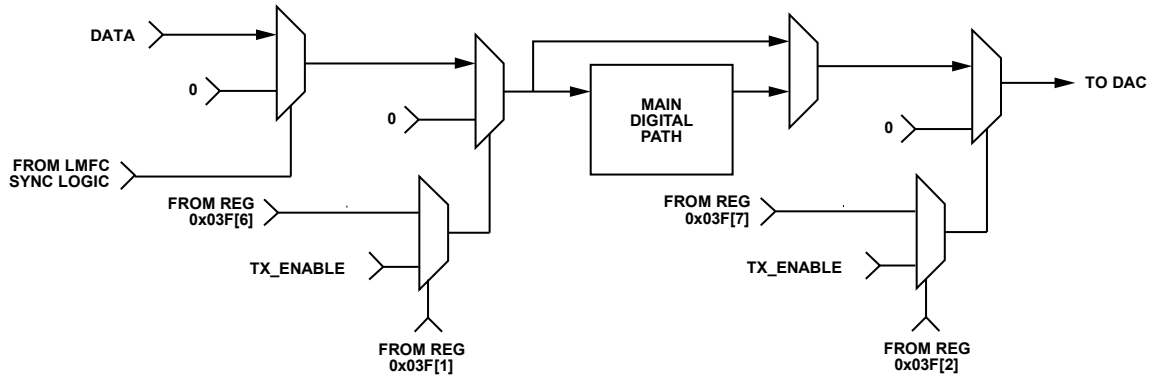

Figure 174. Downstream Protection Block Diagram

14379-110



## INTERRUPT REQUEST OPERATION

The AD9161/AD9162 provide an interrupt request output signal ( $\overline{\text{IRQ}}$ ) on Ball G1 (8 mm × 8 mm package) or Ball G4 (11 mm × 11 mm package) that can be used to notify an external host processor of significant device events. On assertion of the interrupt, query the device to determine the precise event that occurred. The  $\overline{\text{IRQ}}$  pin is an open-drain, active low output. Pull the  $\overline{\text{IRQ}}$  pin high, external to the device. This pin can be tied to the interrupt pins of other devices with open-drain outputs to wire; OR these pins together.

Figure 175 shows a simplified block diagram of how the  $\overline{\text{IRQ}}$  blocks works. If  $\text{IRQ\_EN}$  is low, the  $\text{INTERRUPT\_SOURCE}$  signal is set to 0. If  $\text{IRQ\_EN}$  is high, any rising edge of  $\text{EVENT}$  causes the  $\text{INTERRUPT\_SOURCE}$  signal to be set high. If any  $\text{INTERRUPT\_SOURCE}$  signal is high, the  $\overline{\text{IRQ}}$  pin is pulled low.  $\text{INTERRUPT\_SOURCE}$  can be reset to 0 by either an  $\text{IRQ\_RESET}$  signal or a  $\text{DEVICE\_RESET}$  signal.

Depending on the  $\text{STATUS\_MODE}$  signal, the  $\text{EVENT\_STATUS}$  bit reads back an event signal or  $\text{INTERRUPT\_SOURCE}$  signal. The AD9161/AD9162 have several  $\overline{\text{IRQ}}$  register blocks that can monitor up to 75 events (depending on device configuration). Certain details vary by  $\overline{\text{IRQ}}$  register block as described in Table 39. Table 40 shows the source registers of the  $\text{IRQ\_EN}$ ,  $\text{IRQ\_RESET}$ , and  $\text{STATUS\_MODE}$  signals in Figure 175, as well as the address where  $\text{EVENT\_STATUS}$  is read back.

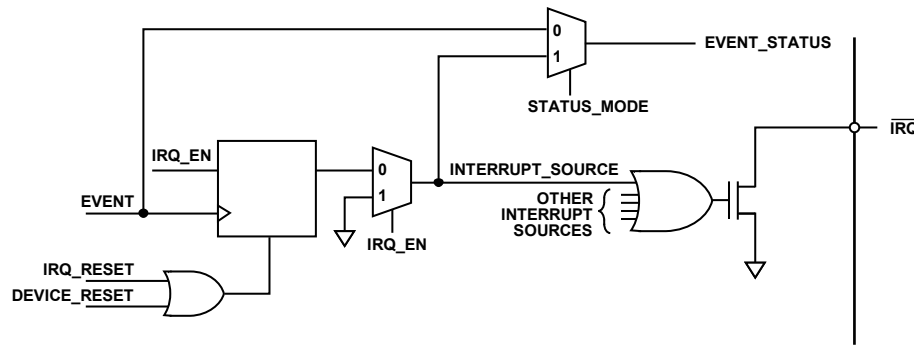

Figure 175. Simplified Schematic of  $\overline{\text{IRQ}}$  Circuitry

Table 39.  $\overline{\text{IRQ}}$  Register Block Details

| Register Block                 | Event Reported    | EVENT_STATUS   |
|--------------------------------|-------------------|--|
| 0x020, 0x024                   | Per chip          | INTERRUPT_SOURCE if $\overline{\text{IRQ}}$ is enabled; if not, it is the event signal |
| 0x4B8 to 0x4BB; 0x470 to 0x473 | Per link and lane | INTERRUPT_SOURCE if $\overline{\text{IRQ}}$ is enabled; if not, 0                      |

### INTERRUPT SERVICE ROUTINE

Interrupt request management starts by selecting the set of event flags that require host intervention or monitoring. Enable the events that require host action so that the host is notified when they occur. For events requiring host intervention upon  $\overline{\text{IRQ}}$  activation, run the following routine to clear an interrupt request:

1. Read the status of the event flag bits that are being monitored.
2. Disable the interrupt by writing 0 to  $\text{IRQ\_EN}$ .
3. Read the event source.
4. Perform any actions that may be required to clear the cause of the event. In many cases, no specific actions may be required.
5. Verify that the event source is functioning as expected.
6. Clear the interrupt by writing 1 to  $\text{IRQ\_RESET}$ .
7. Enable the interrupt by writing 1 to  $\text{IRQ\_EN}$ .

Table 40.  $\overline{\text{IRQ}}$  Register Block Address of  $\overline{\text{IRQ}}$  Signal Details

| Register Block | Address of $\overline{\text{IRQ}}$ Signals |                                |   |                            |
|----------------|--|--------------------------------|---|----------------------------|
|                | IRQ_EN                                     | IRQ_RESET                      | STATUS_MODE <sup>1</sup>                  | EVENT_STATUS               |
| 0x020, 0x024   | 0x020; R/W per chip                        | 0x024; W per chip              | STATUS_MODE = $\overline{\text{IRQ\_EN}}$ | 0x024; R per chip          |
| 0x4B8 to 0x4BB | 0x4B8, 0x4B9; W per error type             | 0x4BA, 0x4BB; W per error type | N/A, STATUS_MODE = 1                      | 0x4BA, 0x4BB; R per chip   |
| 0x470 to 0x473 | 0x470 to 0x473; W per error type           | 0x470 to 0x473; W per link     | N/A, STATUS_MODE = 1                      | 0x470 to 0x473; R per link |

<sup>1</sup> N/A means not applicable.

## APPLICATIONS INFORMATION

### HARDWARE CONSIDERATIONS

#### Power Supply Recommendations

All the AD9161/AD9162 supply domains must remain as noise free as possible for the best operation. Power supply noise has a frequency component that affects performance, and is specified in volts rms terms.

An LC filter on the output of the power supply is recommended to attenuate the noise, and must be placed as close to the AD9161/AD9162 as possible. The VDD12\_CLK supply is the most noise sensitive supply on the device, followed by the VDD25\_DAC and VNEG\_N1P2 supplies, which are the DAC output rails. It is highly recommended that the VDD12\_CLK be supplied by itself with an ultralow noise regulator such as the ADM7154 or ADP1761 or better to achieve the best phase noise performance possible. Noisier regulators impose phase noise onto the DAC output.

The VDD12A supply can be connected to the digital DVDD supply with a separate filter network. All of the SERDES 1.2 V supplies can be connected to one regulator with separate filter networks. The IOVDD supply can be connected to the VDD25\_DAC supply with a separate filter network, or can be powered from a system controller (for example, a microcontroller), 1.8 V to 3.3 V supply. The power supply sequencing requirement must be met; therefore, a switch or other solution must be used when connected to the IOVDD supply with VDD25\_DAC.

Take note of the maximum power consumption numbers given in Table 3 to ensure the power supply design can tolerate temperature and IC process variation extremes. The amount of current drawn is dependent on the chosen use cases, and specifications are provided for several use cases to illustrate examples and contributions from individual blocks, and to assist in calculating the maximum required current per supply.

Another consideration for the power supply design is peak current handling capability. The AD9161/AD9162 draw more current in the main digital supply when synthesizing a signal with significant amplitude variations, such as a modulated signal, as compared to when in idle mode or synthesizing a dc signal. Therefore, the power supply must be able to supply current quickly to accommodate burst signals such as GSM, TDMA, or other signals that have an on/off time domain response. Because the amount of current variation depends on the signals used, it is best to perform lab testing first to establish ranges. A typical difference can be several hundred milliamperes.

#### Power Sequencing

The AD9161/AD9162 require power sequencing to avoid damage to the DAC. A board design with the AD9161/AD9162 must include a power sequencer chip, such as the ADM1184, to ensure that the domains power up in the correct order. The ADM1184 monitors the level of power domains upon power-up. It sends an enable signal to the next grouping of power domains. When all power domains are powered up, a power-good signal is sent to the system controller to indicate all power supplies are powered up.

The IOVDD, VDD12A, VDD12\_CLK, and DVDD domains must be powered up first. Then, the VNEG\_N1P2, VDD\_1P2, PLL\_CLK\_VDD12, DVDD\_1P2, and SYNC\_VDD\_3P3 can be powered up. The VDD25\_DAC domain must be powered up last. There is no requirement for a power-down sequence.

#### Power and Ground Planes

Solid ground planes are recommended to avoid ground loops and to provide a solid, uninterrupted ground reference for the high speed transmission lines that require controlled impedances. It is recommended that power planes be stacked between ground layers for high frequency filtering. Doing so adds extra filtering and isolation between power supply domains in addition to the decoupling capacitors.

Do not use segmented power planes as a reference for controlled impedances unless the entire length of the controlled impedance trace traverses across only a single segmented plane. These and additional guidelines for the topology of high speed transmission lines are described in the JESD204B Serial Interface Inputs (SERDIN0± to SERDIN7±) section.

For some applications, where highest performance and higher output frequencies are required, the choice of PCB materials significantly impacts results. For example, materials such as polyimide or materials from the Rogers Corporation can be used, for example, to improve tolerance to high temperatures and improve performance. Rogers 4350 material is used for the top three layers in some of the evaluation board designs: between the top signal layer and the ground layer below it, between the ground layer and an internal signal layer, and between that signal layer and another ground layer.

#### JESD204B Serial Interface Inputs (SERDIN0± to SERDIN7±)

When considering the layout of the JESD204B serial interface transmission lines, there are many factors to consider to maintain optimal link performance. Among these factors are insertion loss, return loss, signal skew, and the topology of the differential traces.

**Insertion Loss**

The JESD204B specification limits the amount of insertion loss allowed in the transmission channel (see Figure 147). The AD9161/AD9162 equalization circuitry allows significantly more loss in the channel than is required by the JESD204B specification. It is still important that the designer of the PCB minimize the amount of insertion loss by adhering to the following guidelines:

- Keep the differential traces short by placing the AD9161/AD9162 as near the transmitting logic device as possible and routing the trace as directly as possible between the devices.
- Route the differential pairs on a single plane using a solid ground plane as a reference. It is recommended to route the SERDES lanes on the same layer as the AD9161/AD9162 to avoid vias being used in the SERDES lanes.
- Use a PCB material with a low dielectric constant (<4) to minimize loss, if possible.

When choosing between the stripline and microstrip techniques, keep in mind the following considerations: stripline has less loss (see Figure 148 and Figure 149) and emits less EMI, but requires the use of vias that can add complexity to the task of controlling the impedance; whereas microstrip is easier to implement (if the component placement and density allow routing on the top layer) and eases the task of controlling the impedance.

If using the top layer of the PCB is problematic or the advantages of stripline are desirable, follow these recommendations:

- Minimize the number of vias.
- If possible, use blind vias to eliminate via stub effects and use microvias to minimize via inductance.
- If using standard vias, use the maximum via length to minimize the stub size. For example, on an 8-layer board, use Layer 7 for the stripline pair (see Figure 176).
- For each via pair, place a pair of ground vias adjacent to them to minimize the impedance discontinuity (see Figure 176).

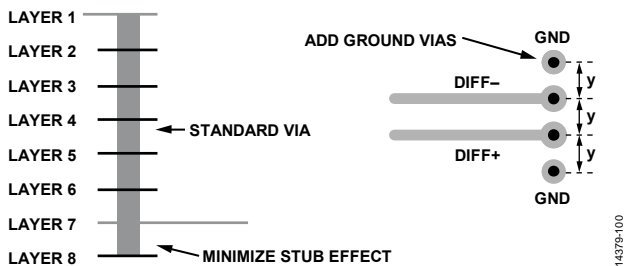

Figure 176. Minimizing Stub Effect and Adding Ground Vias for Differential Stripline Traces

**Return Loss**

The JESD204B specification limits the amount of return loss allowed in a converter device and a logic device, but does not specify return loss for the channel. However, every effort must be made to maintain a continuous impedance on the transmis-

sion line between the transmitting logic device and the AD9161/AD9162. Minimizing the use of vias, or eliminating them all together, reduces one of the primary sources for impedance mismatches on a transmission line (see the Insertion Loss section). Maintain a solid reference beneath (for microstrip) or above and below (for stripline) the differential traces to ensure continuity in the impedance of the transmission line. If the stripline technique is used, follow the guidelines listed in the Insertion Loss section to minimize impedance mismatches and stub effects.

Another primary source for impedance mismatch is at either end of the transmission line, where care must be taken to match the impedance of the termination to that of the transmission line. The AD9161/AD9162 handle this internally with a calibrated termination scheme for the receiving end of the line. See the Interface Power-Up and Input Termination section for details on this circuit and the calibration routine.

**Signal Skew**

There are many sources for signal skew, but the two sources to consider when laying out a PCB are interconnect skew within a single JESD204B link and skew between multiple JESD204B links. In each case, keeping the channel lengths matched to within 12.5 mm is adequate for operating the JESD204B link at speeds of up to 12.5 Gbps. This amount of channel length match is equivalent to about 85% UI on the AD9161/AD9162 evaluation board. Managing the interconnect skew within a single link is fairly straightforward. Managing multiple links across multiple devices is more complex. However, follow the 12.5 mm guideline for length matching. The AD9161/AD9162 can handle more skew than the 85% UI due to the 6 PCLK buffer in the JESD204B receiver, but matching the channel lengths as close as possible is still recommended.

**Topology**

Structure the differential SERDINx± pairs to achieve 50 Ω to ground for each half of the pair. Stripline vs. microstrip trade-offs are described in the Insertion Loss section. In either case, it is important to keep these transmission lines separated from potential noise sources such as high speed digital signals and noisy supplies. If using stripline differential traces, route them using a coplanar method, with both traces on the same layer. Although this method does not offer more noise immunity than the broadside routing method (traces routed on adjacent layers), it is easier to route and manufacture so that the impedance continuity is maintained. An illustration of broadside vs. coplanar is shown in Figure 177.

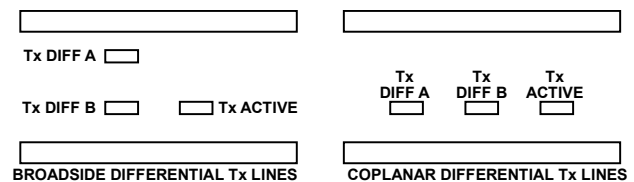

Figure 177. Broadside vs. Coplanar Differential Stripline Routing Techniques

When considering the trace width vs. copper weight and thickness, the speed of the interface must be considered. At multigigabit speeds, the skin effect of the conducting material confines the current flow to the surface. Maximize the surface area of the conductor by making the trace width made wider to reduce the losses. Additionally, loosely couple differential traces to accommodate the wider trace widths. This coupling helps reduce the crosstalk and minimize the impedance mismatch when the traces must separate to accommodate components, vias, connectors, or other routing obstacles. Tightly coupled vs. loosely coupled differential traces are shown in Figure 178.

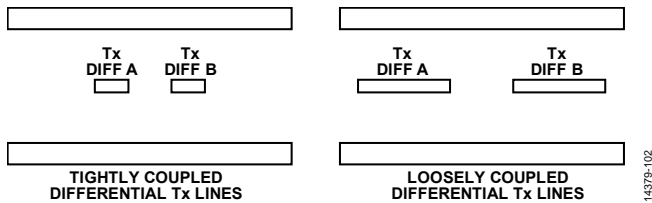

Figure 178. Tightly Coupled vs. Loosely Coupled Differential Traces

AC Coupling Capacitors

The AD9161/AD9162 require that the JESD204B input signals be ac-coupled to the source. These capacitors must be 100 nF

and placed as close as possible to the transmitting logic device. To minimize the impedance mismatch at the pads, select the package size of the capacitor so that the pad size on the PCB matches the trace width as closely as possible.

SYNCOUT±, SYSREF±, and CLK± Signals

The SYNCOUT± and SYSREF± signals on the AD9161/AD9162 are low speed LVDS differential signals. Use controlled impedance traces routed with 100 Ω differential impedance and 50 Ω to ground when routing these signals. As with the SERDIN0± to SERDIN7± data pairs, it is important to keep these signals separated from potential noise sources such as high speed digital signals and noisy supplies.

Separate the SYNCOUT± signal from other noisy signals, because noise on the SYNCOUT± might be interpreted as a request for /K/ characters.

It is important to keep similar trace lengths for the CLK± and SYSREF± signals from the clock source to each of the devices on either end of the JESD204B links (see Figure 179). If using a clock chip that can tightly control the phase of CLK± and SYSREF±, the trace length matching requirements are greatly reduced.

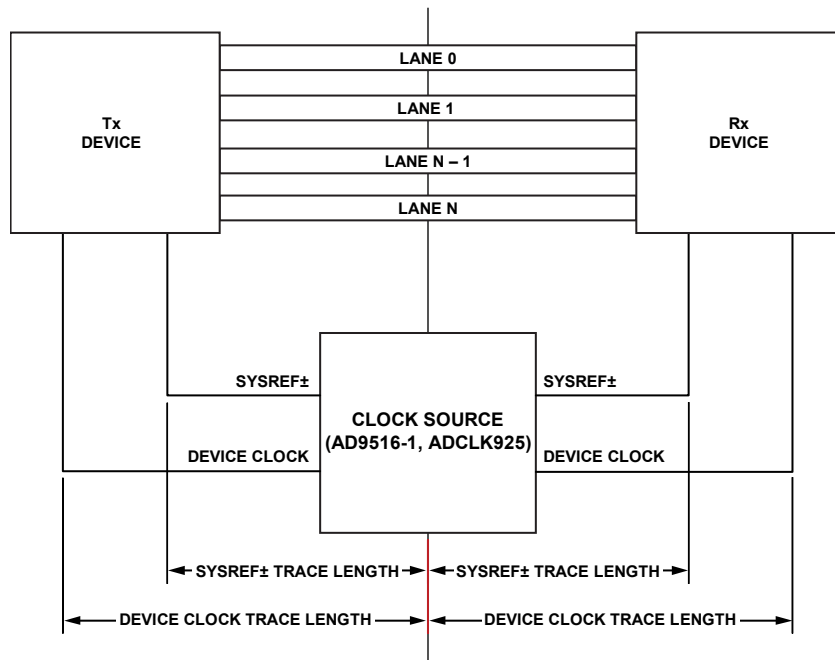

Figure 179. SYSREF± Signal and Device Clock Trace Length

# ANALOG INTERFACE CONSIDERATIONS

## ANALOG MODES OF OPERATION

The AD9161/AD9162 use the quad-switch architecture shown in Figure 180. Only one pair of switches is enabled during a half-clock cycle, thus requiring each pair to be clocked on alternative clock edges. A key benefit of the quad-switch architecture is that it masks the code dependent glitches that occur in the conventional two-switch DAC architecture.

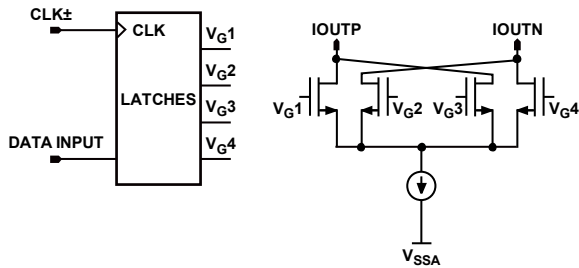

Figure 180. Quad-Switch Architecture

In two-switch architecture, when a switch transition occurs and  $D_1$  and  $D_2$  are in different states, a glitch occurs. However, if  $D_1$  and  $D_2$  happen to be at the same state, the switch transitions and no glitches occur. This code dependent glitching causes an increased amount of distortion in the DAC. In quad-switch architecture (no matter what the codes are), there are always two switches that are transitioning at each half-clock cycle, thus eliminating the code-dependent glitches but, in the process, creating a constant glitch at  $2 \times f_{DAC}$ . For this reason, a significant clock spur at  $2 \times f_{DAC}$  is evident in the DAC output spectrum.

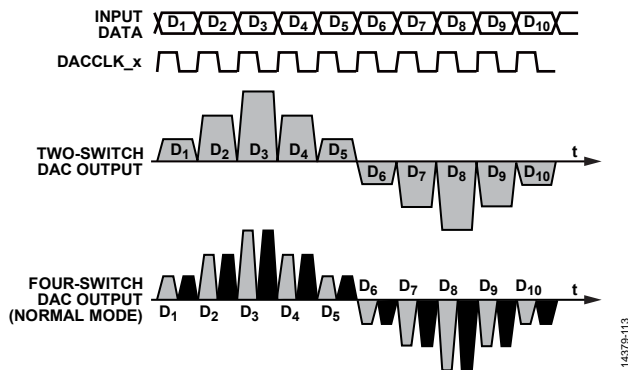

Figure 181. Two-Switch and Quad-Switch DAC Waveforms

As a consequence of the quad-switch architecture enabling updates on each half-clock cycle, it is possible to operate that DAC core at  $2 \times$  the DAC clock rate if new data samples are latched into the DAC core on both the rising and falling edge of the DAC clock. This notion serves as the basis when operating the AD9161/AD9162 in either Mix-Mode or return to zero (RZ) mode. In each case, the DAC core is presented with new data samples on each clock edge: in RZ mode, the rising edge clocks data and the falling edge clocks zero, while in Mix-Mode; the falling edge sample is simply the complement of the rising edge sample value.

When Mix-Mode is used, the output is effectively chopped at the DAC sample rate. This chopping has the effect of reducing the power of the fundamental signal while increasing the power of the images centered around the DAC sample rate, thus improving the dynamic range of these images.

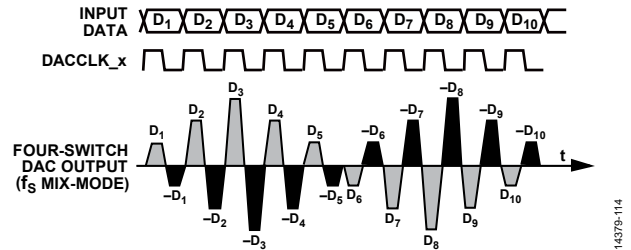

Figure 182. Mix-Mode Waveform

This ability to change modes provides the user the flexibility to place a carrier anywhere in the first three Nyquist zones, depending on the operating mode selected. Switching between baseband and Mix-Mode reshapes the sinc roll-off inherent at the DAC output. In baseband mode, the sinc null appears at  $f_{DACCLK}$  because the same sample latched on the rising clock edge is also latched again on the falling clock edge, thus resulting in the same ubiquitous sinc response of a traditional DAC. In Mix-Mode, the complement sample of the rising edge is latched on the falling edge, therefore pushing the sinc null to  $2 \times f_{DACCLK}$ . Figure 183 shows the ideal frequency response of the three modes with the sinc roll-off included.

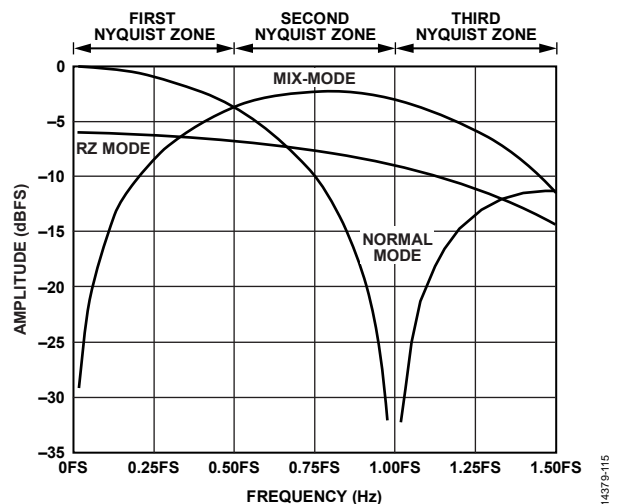

Figure 183. Sinc Roll-Off for NRZ, RZ, and Mix-Mode Operation

The quad-switch can be configured via SPI (Register 0x152, Bits[1:0]) to operate in either NRZ mode (0b00), RZ mode (0b10), or Mix-Mode (0b01). The AD9161/AD9162 have an additional frequency response characteristic due to the FIR85 filter. This filter samples data on both the rising and falling edges of the DAC clock, in essence doubling the input clock frequency. As a result, the NRZ (normal) mode roll-off in Figure 183 is extended to  $2 \times f_{DAC}$  in Figure 183, and follows the

Mix-Mode roll-off due to the zero-order hold at  $2 \times$  DAC clock (see Figure 184).

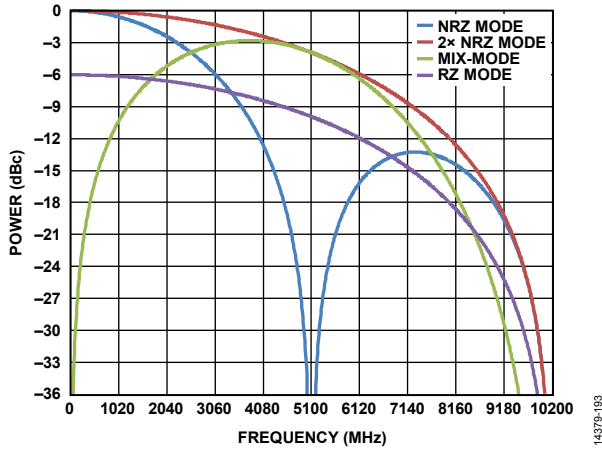

Figure 184. Sinc Roll-Off with  $2 \times$  NRZ Mode Added,  $f_{DAC} = 5.1$  GSPS

**CLOCK INPUT**

The AD9161/AD9162 contain a low jitter, differential clock receiver that is capable of interfacing directly to a differential or single-ended clock source. Because the input is self biased with a nominal impedance of  $90 \Omega$ , it is recommended that the clock source be ac-coupled to the CLK± input pins. The nominal differential input is 1 V p-p, but the clock receiver can operate with a span that ranges from 250 mV p-p to 2.0 V p-p. Better phase noise performance is achieved with a higher clock input level.

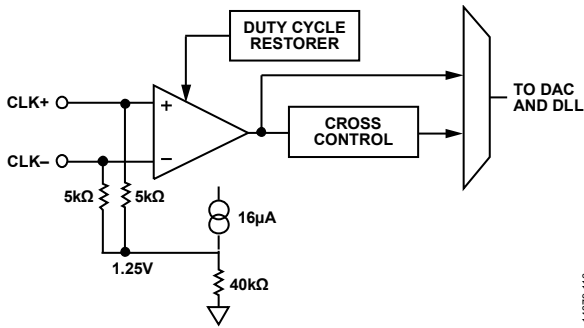

Figure 185. Clock Input

The quality of the clock source, as well as its interface to the AD9161/AD9162 clock input, directly impacts ac performance.

Select the phase noise and spur characteristics of the clock source to meet the target application requirements. Phase noise and spurs at a given frequency offset on the clock source are directly translated to the output signal. It can be shown that the phase noise characteristics of a reconstructed output sine wave are related to the clock source by  $20 \times \log_{10}(f_{OUT}/f_{CLK})$  when the DAC clock path contribution is negligible.

Figure 186 shows a clock source based on the ADF4355 low phase noise/jitter PLL. The ADF4355 can provide output frequencies from 54 MHz up to 6.8 GHz.

The clock control registers exist at Address 0x082 through Address 0x084. CLK\_DUTY (Register 0x082) can be used to enable duty cycle correction (Bit 7), enable duty cycle offset control (Bit 6), and set the duty cycle offset (Bits[4:0]). The duty cycle offset word is a signed magnitude word, with Bit 4 being the sign bit (1 is negative) and Bits[3:0] the magnitude. The duty cycle adjusts across a range of approximately  $\pm 3\%$ . Recommended settings for this register are listed in the Start-Up Sequence section.

The clock input has a register that adjusts the phase of the CLK+ and CLK- inputs. This register is located at Address 0x07F. The register has a signed magnitude (1 is negative) value that adds capacitance at 20 fF per step to either the CLK+ or the CLK- input, according to Table 41. The CLK\_PHASE\_TUNE register can be used to adjust the clock input phase for better DAC image rejection.

Table 41. CLK± Phase Adjust Values

| Register 0x07F, Bits[5:0] | Capacitance at CLK+ | Capacitance at CLK- |
|---------------------------|---------------------|---------------------|
| 000000                    | 0                   | 0                   |
| 000001                    | $1 \times 20$ fF    | 0                   |
| 000010                    | $2 \times 20$ fF    | 0                   |
| ...                       | ...                 | ...                 |
| 011111                    | $31 \times 20$ fF   | 0                   |
| 100000                    | 0                   | 0                   |
| 100001                    | 0                   | $1 \times 20$ fF    |
| 100010                    | 0                   | $2 \times 20$ fF    |
| ...                       | ...                 | ...                 |
| 111111                    | 0                   | $31 \times 20$ fF   |

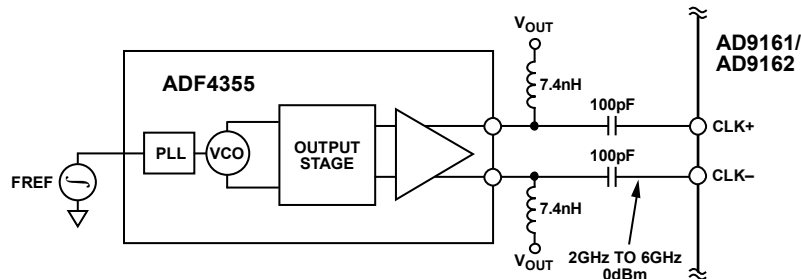

Figure 186. Possible Signal Chain for CLK± Input

The improvement in performance from making these adjustments depends on the accuracy of the balance of the clock input balun and varies from unit to unit. Thus, if a high level of image rejection is required, it is likely that a per unit calibration is necessary. Performing this calibration can yield significant improvements, as much as 20 dB additional rejection of the image due to imbalance. Figure 187 shows the results of tuning clock phase, duty cycle (left at default in this case), and cross control. The improvement to performance, particularly at higher frequencies, can be as much as 20 dB.

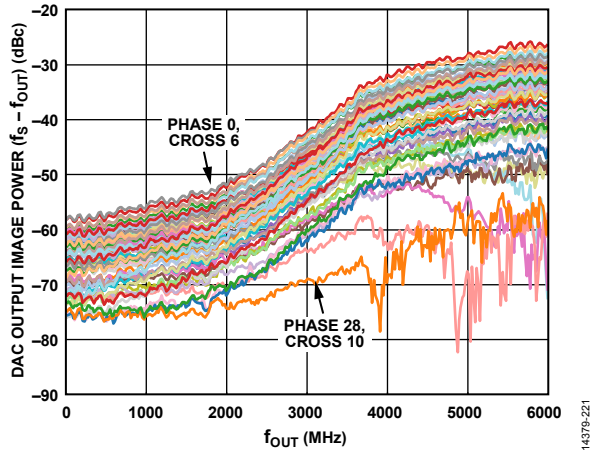

Figure 187. Performance Improvement from Tuning the Clock Input

### SHUFFLE MODE

The spurious performance of the AD9161/AD9162 can be improved with a feature called shuffle mode. Shuffle mode uses proprietary technology to spread the energy of spurious signals across the DAC output as random noise. Shuffle mode is enabled by programming Register 0x151, Bit 2 = 0b1. Because shuffle is implemented with the MSBs, it is more effective when the DAC is operated with a small amount of digital backoff.

The amount of noise rise caused by shuffle mode is directly related to the power in the affected spurious signals. Because the AD9161/AD9162 have good spurious performance without shuffle active, the penalty of shuffle mode to the noise spectral density is typically about 1 dB to 3 dB. Shuffle mode reduces spurious performance related to clock and foldback spurs, but does not affect real harmonics of the DAC output. Examples of the effects of shuffle mode are given in the Typical Performance Characteristics section (see Figure 18, Figure 19, Figure 33, Figure 34, Figure 100, Figure 101, Figure 115, Figure 116, and Figure 117).

### DLL

The CLK± input goes to a high frequency DLL to ensure robust locking of the DAC sample clock to the input clock. The DLL is configured and enabled as part of the recommended start-up sequence. The DLL control registers are located at Register 0x090 through Register 0x09B. The DLL settings are determined during product characterization and are given in the recommended start-up sequence (see the Start-Up Sequence section). It is not

normally necessary to change these values, nor is the product characterization data valid on any settings other than the recommended ones.

### VOLTAGE REFERENCE

The AD9161/AD9162 output current is set by a combination of digital control bits and the ISET reference current, as shown in Figure 188.

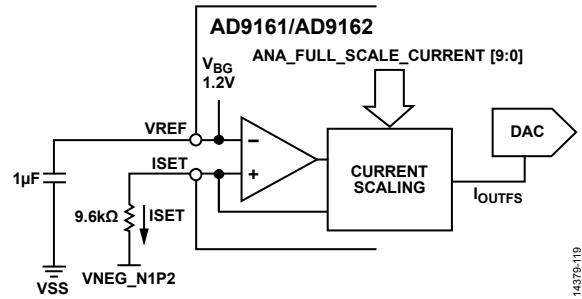

Figure 188. Voltage Reference Circuit

The reference current is obtained by forcing the band gap voltage across an external 9.6 kΩ resistor from ISET (Ball A15 on the 8 mm × 8 mm package and Ball A12 on the 11 mm × 11 mm package) to VNEG\_N1P2. The 1.2 V nominal band gap voltage (VREF) generates a 125 μA reference current, ISET, in the 9.6 kΩ resistor, RSET. The maximum full-scale current setting is related to the external resistor by the following equation:

$$I_{OUTFS} = 1.2 \text{ V} / R_{SET} (\text{k}\Omega) \times 320 (\text{mA})$$

Note the following constraints when configuring the voltage reference circuit:

- Both the 9.6 kΩ resistor and 1 μF bypass capacitor are required for proper operation.
- Adjusting the DAC output full-scale current, IOUTFS, from its default setting of 40 mA must be performed digitally.
- The AD9161/AD9162 are not multiplying DACs. Modulation of the reference current, ISET, with an ac signal is not supported.
- The band gap voltage appearing at the VREF pin must be buffered for use with an external circuitry because it has a high output impedance.
- An external reference can be used to overdrive the internal reference by connecting it to the VREF pin.

The IOUTFS value can be adjusted digitally over an 8 mA to 40 mA range by the ANA\_FULL\_SCALE\_CURRENT[9:0] bits (Register 0x042, Bits[7:0] and Register 0x041, Bits[1:0]). The following equation relates IOUTFS to the ANA\_FULL\_SCALE\_CURRENT[9:0] bits, which can be set from 0 to 1023.

$$I_{OUTFS} = 32 \text{ mA} \times (\text{ANA\_FULL\_SCALE\_CURRENT}[9:0] / 1023) + 8 \text{ mA}$$

Note that the default value of 0x3FF generates 40 mA full scale, and this value is used for most of the characterization presented in this data sheet, unless noted otherwise.

**TEMPERATURE SENSOR**

The AD9161/AD9162 has a band gap temperature sensor for monitoring the temperature changes of the AD9161/AD9162. The temperature must be calibrated against a known temperature to remove the device-to-device variation on the band gap circuit used to sense the temperature.

To calibrate, the user must take a reading at a known ambient temperature for a single-point calibration of each AD9161/AD9162 device. The slope for the formula is then calculated as

$$M = (T_{REF} + 190)/((CODE\_REF)/1000)$$

where:

$T_{REF}$  is the temperature at which the temp sensor is read,  $CODE\_REF$  is the readback code at the measured temperature,  $T_{REF}$ .

To monitor temperature change,

$$T_X = T_{REF} + M \times (CODE\_X - CODE\_REF)/1000$$

where:

$CODE\_X$  is the readback code at the unknown temperature,  $T_X$ .  $CODE\_REF$  is the readback code at the calibrated temperature,  $T_{REF}$ .

To use the temperature sensor, it must be enabled by setting Register 0x135 to 0xA1. The user must write a 1 to Register 0x134, Bit 0 before reading back the die temperature from Register 0x132 (LSB) and Register 0x133 (MSB).

**ANALOG OUTPUTS**

**Equivalent DAC Output and Transfer Function**

The AD9161/AD9162 provide complementary current outputs, OUTPUT+ and OUTPUT-, that sink current from an external load that is referenced to the 2.5 V VDD25\_DAC supply. Figure 189 shows an equivalent output circuit for the DAC. Compared to most current output DACs of this type, the outputs of the AD9161/AD9162 consist of a constant current ( $I_{FIXED}$ ), and a peak differential ac current,  $I_{CS}$  ( $I_{CS} = I_{CSP} + I_{CSN}$ ). These two currents combine to form the  $I_{INTX}$  currents shown in Figure 189. The internal currents,  $I_{INTP}$  and  $I_{INTN}$ , are sent to the output pin and to an input termination resistance equivalent to 100  $\Omega$  pulled to the VDD25\_DAC supply ( $R_{INT}$ ). This termination serves to divide the output current based on the external termination resistors that are pulled to VDD25\_DAC.

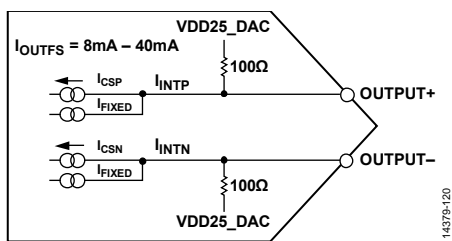

Figure 189. Equivalent DAC Output Circuit

The example shown in Figure 189 can be modeled as a pair of dc current sources that source a current of  $I_{OUT}$  to each output. This differential ac current source is used to model the signal (that is, a digital code) dependent nature of the DAC output.

The polarity and signal dependency of this ac current source are related to the digital code (F) by the following equation:

$$F (code) = (DACCODE - 32,768)/32,768 \tag{2}$$

where:

$$-1 \leq F (code) < +1.$$

$DACCODE = 0$  to 65,535 (decimal).

The current that is measured at the OUTPUT+ and OUTPUT- outputs is as follows:

$$OUTPUT+ = (I_{FIXED} (mA) + (F \times I_{OUTFS})/F_{MAX}(mA)) \times (R_{INT}/(R_{INT} + R_{LOAD})) \tag{3}$$

$$OUTPUT- = (I_{FIXED} (mA) + ((F_{MAX} - F) \times I_{OUTFS})/F_{MAX}(mA)) \times (R_{INT}/(R_{INT} + R_{LOAD}))$$

The  $I_{FIXED}$  value is about 3.8 mA. It is important to note that the AD9161/AD9162 output cannot support dc coupling to the external load, and thus must be ac-coupled through appropriately sized capacitors for the chosen operating frequencies. Figure 190 shows the OUTPUT+ vs. DAC code transfer function when  $I_{OUTFS}$  is set to 40 mA.



Figure 190. Gain Curve for ANA\_FULL\_SCALE\_CURRENT[9:0] = 1023, DAC Offset = 3.8 mA

**Peak DAC Output Power Capability**

The maximum peak power capability of a differential current output DAC is dependent on its peak differential ac current,  $I_{PEAK}$ , and the equivalent load resistance it sees. In the case of a 1:1 balun with 100  $\Omega$  differential source termination, the equivalent load that is seen by the DAC ac current source is 50  $\Omega$ . If the AD9161/AD9162 are programmed for an  $I_{OUTFS} = 40$  mA, its ideal peak ac current is 20 mA and its maximum power, delivered to the equivalent load, is  $10 \times (R_{INT}/(R_{INT} + R_{LOAD})) = 8$  mW, that is,  $P = I^2R$ . Because the source and load resistance seen by the 1:1 balun are equal, this power is shared equally. Therefore, the output load receives 4 mW or 6 dBm maximum power.

To calculate the rms power delivered to the load, consider the following:

- Peak to rms of the digital waveform
- Any digital backoff from digital full scale
- DAC sinc response and nonideal losses in the external network



- DAC analog roll-off due to switch parasitic capacitance and load impedance

For example, a sine wave with no digital backoff ideally measures 6 dBm. If a typical balun loss of 1.2 dB is included, expect to measure 4.8 dBm of actual power in the region where the sinc response of the DAC has negligible influence and analog roll-off has not begun. Increasing the output power is best accomplished by increasing  $I_{OUTFS}$ . An example of DAC output characteristics for several balun and board types is shown in Figure 192.

**Output Stage Configuration**

The AD9161/AD9162 are intended to serve high dynamic range applications that require wide signal reconstruction bandwidth (such as a DOCSIS cable modem termination system (CMTS)) and/or high IF/RF signal generation. Optimum ac performance can be realized only when the DAC output is configured for differential (that is, balanced) operation with its output common-mode voltage biased to a stable, low noise 2.5 V nominal analog supply (VDD25\_DAC).

The output network used to interface to the DAC provides a near 0 Ω dc bias path to VDD25\_DAC. Any imbalance in the output impedance over frequency between the OUTPUT+ and OUTPUT- pins degrades the distortion performance (mostly even order) and noise performance. Component selection and layout are critical in realizing the performance potential of the AD9161/AD9162.

Most applications that require balanced to unbalanced conversion from 10 MHz to 3 GHz can take advantage of several available transformers that offer impedance ratios of both 2:1 and 1:1.

Figure 191 shows the AD9161/AD9162 interfacing to the Mini-Circuits TCM1-63AX+ and the TC1-1-43X+ transformers.

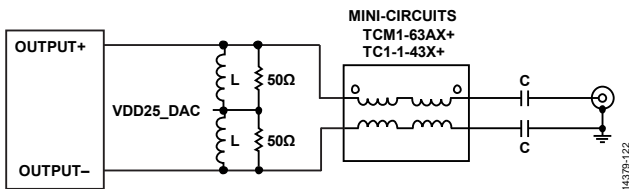

Figure 191. Recommended Transformer for Wideband Applications with Upper Bandwidths of up to 5 GHz

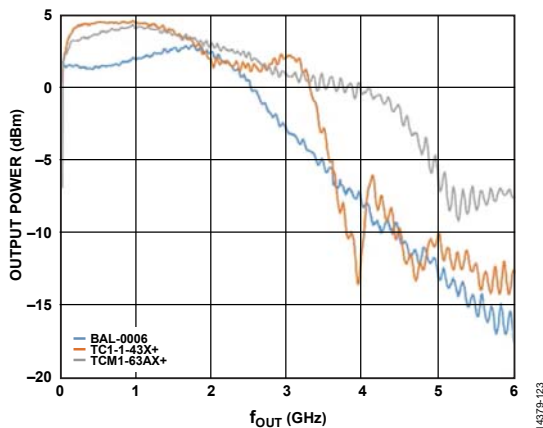

Figure 192. Measured DAC Output Response;  $f_{DAC} = 6$  GSFS

To assist in matching the AD9161/AD9162 output, an equivalent model of the output was developed, and is shown in Figure 193. This equivalent model includes all effects from the ideal 40 mA current source in the die to the ball of the CSP\_BGA package, including parasitic capacitance, trace inductance and resistance, contact resistance of solder bumps, via inductance, and other effects.

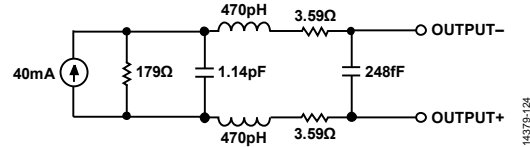
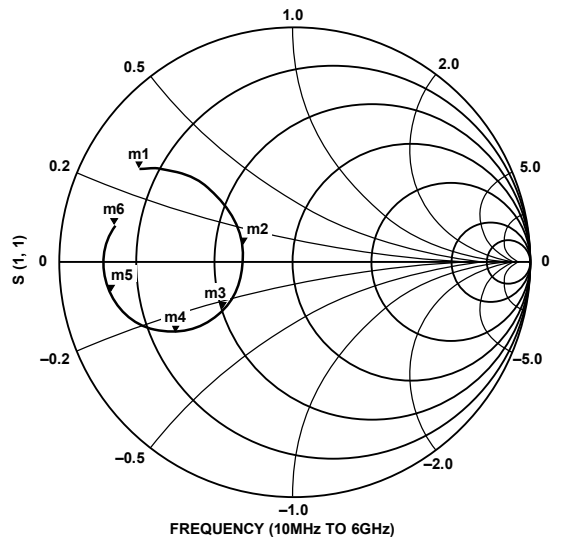

Figure 193. Equivalent Circuit Model of the DAC Output

A Smith chart is provided in Figure 194 showing the simulated S11 of the DAC output, using the model in Figure 193. The plot was taken using the circuit in Figure 193, with a 100 Ω differential load instead of the balun. For the measured response of the DAC output, see Figure 192.



|   |  |
|---|--|
| <p>m1<br/>FREQUENCY = 10MHz<br/>S (1, 1) = 0.770/149.556<br/>IMPEDANCE = Z0 × (0.140 + j0.267)</p>  | <p>m4<br/>FREQUENCY = 2GHz<br/>S (1, 1) = 0.583/-148.777<br/>IMPEDANCE = Z0 × (0.282 - j0.259)</p> |
| <p>m2<br/>FREQUENCY = 100MHz<br/>S (1, 1) = 0.227/163.083<br/>IMPEDANCE = Z0 × (0.638 + j0.089)</p> | <p>m5<br/>FREQUENCY = 4GHz<br/>S (1, 1) = 0.794/-170.517<br/>IMPEDANCE = Z0 × (0.116 - j0.082)</p> |
| <p>m3<br/>FREQUENCY = 1GHz<br/>S (1, 1) = 0.367/-144.722<br/>IMPEDANCE = Z0 × (0.499 - j0.245)</p>  | <p>m6<br/>FREQUENCY = 6GHz<br/>S (1, 1) = 0.779/168.448<br/>IMPEDANCE = Z0 × (0.125 + j0.100)</p>  |

Figure 194. Simulated Smith Chart Showing the DAC Output Impedance ( $Z_0 = 100\Omega$ )

## START-UP SEQUENCE

A number of steps is required to program the AD9161/AD9162 to the proper operating state after the device is powered up. This sequence is divided into several steps, and is listed in Table 42, Table 43, and Table 44, along with an explanation of the purpose of each step. Private registers are reserved but must be written for proper operation. Blank cells in Table 42 to Table 44 mean that the value depends on the result as described in the description column.

The AD9161/AD9162 are calibrated at the factory as part of the automatic test program. The configure DAC start-up sequence loads the factory calibration coefficients, as well as configures some parameters that optimize the performance of the DAC

and the DAC clock DLL (see Table 42). Run this sequence whenever the DAC is powered down or reset.

The configure JESD204B sequence configures the SERDES block and then brings up the links (see Table 43). First, run the configure DAC start-up sequence, then run the configure JESD204B sequence.

Follow the configure NCO sequence if using the NCO (see Table 44). Note that the NCO can be used in NCO only mode or in conjunction with synthesized data from the SERDES data interface. Only one mode can be used at a time and this mode is selected in the second step in Table 44. The configure DAC start-up sequence is run first, then the configure NCO sequence.

**Table 42. Configure DAC Start-Up Sequence After Power-Up**

| R/W | Register                   | Value            | Description  |
|-----|----------------------------|------------------|--|
| W   | 0x000                      | 0x18             | Configure the device for 4-wire serial port operation (optional: leave at the default of 3-wire SPI)   |
| W   | 0x0D2                      | 0x52             | Reset internal calibration registers (private)   |
| W   | 0x0D2                      | 0xD2             | Clear the reset bit for the internal calibration registers (private)   |
| W   | 0x606                      | 0x02             | Configure the nonvolatile random access memory (NVRAM) (private)   |
| W   | 0x607                      | 0x00             | Configure the NVRAM (private)  |
| W   | 0x604                      | 0x01             | Load the NVRAM. Loads factory calibration factors from the NVRAM. (private) <sup>1</sup>   |
| R   | 0x003, 0x004, 0x005, 0x006 | N/A <sup>2</sup> | (Optional) read CHIP_TYPE, PROD_ID[15:0], PROD_GRADE, and DEV_REVISION from Register 0x003, Register 0x004, Register 0x005, and Register 0x006 |
| R   | 0x604, Bit 1               | 0b1              | (Optional) read the boot loader pass bit in Register 0x604, Bit 1 = 0b1 to indicate a successful boot load                                     |
| W   | 0x058                      | 0x03             | Enable the band gap reference (private)  |
| W   | 0x090                      | 0x1E             | Power up the DAC clock DLL   |
| W   | 0x080                      | 0x00             | Enable the clock receiver  |
| W   | 0x040                      | 0x00             | Enable the DAC bias circuits   |
| W   | 0x020                      | 0x0F             | Optional. Enable the interrupts  |
| W   | 0x09E                      | 0x85             | Configure DAC analog parameters (private)  |
| W   | 0x091                      | 0xE9             | Enable the DAC clock DLL   |
| R   | 0x092, Bit 0               | 0b1              | Check DLL_STATUS; set Register 0x092, Bit 0 = 1 to indicate the DAC clock DLL is locked to the DAC clock input                                 |
| W   | 0x0E8                      | 0x20             | Enable calibration factors (private)   |
| W   | 0x152, Bits[1:0]           |                  | Configure the DAC decode mode (0b00 = NRZ, 0b01 = mix mode, or 0b10 = RZ)  |

<sup>1</sup> After the NVRAM is loaded, the readback values of registers 0x004 and 0x005 change to 0x004 = 0x62 for the AD9162, 0x004 = 0x61 for the AD9161, 0x005 = 0x91.

<sup>2</sup> N/A means not applicable.

**Table 43. Configure JESD204B Start-Up Sequence**

| R/W | Register | Value | Description   |
|-----|----------|-------|---|
| W   | 0x300    | 0x00  | Ensure the SERDES links are disabled before configuring them.             |
| W   | 0x4B8    | 0xFF  | Enable JESD204B interrupts.   |
| W   | 0x4B9    | 0x01  | Enable JESD204B interrupts.   |
| W   | 0x480    | 0x38  | Enable SERDES error counters.   |
| W   | 0x481    | 0x38  | Enable SERDES error counters.   |
| W   | 0x482    | 0x38  | Enable SERDES error counters.   |
| W   | 0x483    | 0x38  | Enable SERDES error counters.   |
| W   | 0x484    | 0x38  | Enable SERDES error counters.   |
| W   | 0x485    | 0x38  | Enable SERDES error counters.   |
| W   | 0x486    | 0x38  | Enable SERDES error counters.   |
| W   | 0x487    | 0x38  | Enable SERDES error counters.   |
| W   | 0x110    |       | Configure number of lanes (Bits[7:4]) and interpolation rate (Bits[3:0]). |

| R/W | Register         | Value | Description  |
|-----|------------------|-------|--|
| W   | 0x111            |       | Configure the datapath options for Bit 7 (INVSINC_EN), Bit 6 (NCO_EN), Bit 4 (FILT_BW), Bit 2 (MODULUS_EN), Bit 1 (SEL_SIDE BAND), and Bit 0 (FIR85_FILT_EN). See the Register Summary section for details on the options. Set the reserved bits (Bit 5 and Bit 3) to 0b0. |
| W   | 0x230            |       | Configure the CDR block according to Table 20 for both half rate enable and the divider.   |
| W   | 0x289, Bits[1:0] |       | Set up the SERDES PLL divider based on the conditions shown in Table 19.   |
| W   | 0x084, Bits[5:4] |       | Set up the PLL reference clock rate based on the conditions shown in Table 19.   |
| W   | 0x200            | 0x00  | Enable JESD204B block (disable master SERDES power-down).  |
| W   | 0x475            | 0x09  | Soft reset the JESD204B quad-byte deframer.  |
| W   | 0x453, Bit 7     | 0b1   | (Optional) Enable scrambling on SERDES lanes.  |
| W   | 0x458, Bits[7:5] |       | Set the subclass type: 0b000 = Subclass 0, 0b001 = Subclass 1.   |
| W   | 0x459, Bits[7:5] | 0b1   | Set the JESD204x version to JESD204B.  |
| W   | 0x45D            |       | Program the calculated checksum value for Lane 0 from values in Register 0x450 to Register 0x45C.  |
| W   | 0x475            | 0x01  | Bring the JESD204B quad-byte deframer out of reset.  |
| W   | 0x201, Bits[7:0] |       | Set any bits to 1 to power down the appropriate physical lane.   |
| W   | 0x2A7            | 0x01  | (Optional) Calibrate SERDES PHY Termination Block 1 (PHY 0, PHY 1, PHY 6, PHY 7).  |
| W   | 0x2AE            | 0x01  | (Optional) Calibrate SERDES PHY Termination Block 2 (PHY 2, PHY 3, PHY 4, PHY 5).  |
| W   | 0x29E            | 0x1F  | Override defaults in the SERDES PLL settings (private).  |
| W   | 0x206            | 0x00  | Reset the CDR.   |
| W   | 0x206            | 0x01  | Enable the CDR.  |
| W   | 0x280            | 0x01  | Enable the SERDES PLL.   |
| R   | 0x281, Bit 0     | 0b1   | Read back Register 0x281 until Bit 0 = 1 to indicate the SERDES PLL is locked. Prior to enabling the links, be sure that the JESD204B transmitter is enabled and ready to begin bringing up the link.  |
| W   | 0x300            | 0x01  | Enable SERDES links (begin bringing up the link).  |
| R   | 0x470            | 0xFF  | Read the CGS status for all lanes.   |
| R   | 0x471            | 0xFF  | Read the frame sync status for all lanes.  |
| R   | 0x472            | 0xFF  | Read the good checksum status for all lanes.   |
| R   | 0x473            | 0xFF  | Read the initial lane sync status for all lanes.   |
| W   | 0x024            | 0x1F  | Clear the interrupts.  |
| W   | 0x4BA            | 0xFF  | Clear the SERDES interrupts.   |
| W   | 0x4BB            | 0x01  | Clear the SERDES interrupt.  |

Table 44. Configure NCO Sequence

| R/W | Register     | Value | Description  |
|-----|--------------|-------|--|
| W   | 0x110        | 0x80  | (Optional) Perform this write if NCO only mode is desired (AD9162 only).   |
| W   | 0x111, Bit 6 | 0b1   | Configure NCO_EN (Bit 6) = 0b1. Configure other datapath options for Bit 7 (INVSINC_EN), Bit 4 (FILT_BW), Bit 2 (MODULUS_EN), Bit 1 (SEL_SIDE BAND), and Bit 0 (FIR85_FILT_EN). See the Register Summary section for details on the options. Set the reserved bits (Bit 5 and Bit 3) to 0b0. |
| W   | 0x150, Bit 1 |       | Configure the DC_TEST_EN bit: 0b0 = NCO operation with data interface; 0b1 = NCO only mode (AD9162 only).  |
| W   | 0x14E        |       | Write the amplitude value for tone amplitude in NCO only mode, Bits [15:8] (AD9162 only).  |
| W   | 0x14F        |       | Write the amplitude value for tone amplitude in NCO only mode, Bits [7:0] (AD9162 only).   |
| W   | 0x113        | 0x00  | Ensure the frequency tuning word write request is low.   |
| W   | 0x119        |       | Write FTW, Bits[47:40].  |
| W   | 0x118        |       | Write FTW, Bits[39:32].  |
| W   | 0x117        |       | Write FTW, Bits[31:24].  |
| W   | 0x116        |       | Write FTW, Bits[23:16].  |
| W   | 0x115        |       | Write FTW, Bits[15:8].   |
| W   | 0x114        |       | Write FTW, Bits[7:0].  |
| W   | 0x113        | 0x01  | Load the FTW to the NCO.   |

## REGISTER SUMMARY

Table 45. Register Summary

| Reg.  | Name                  | Bits  | Bit 7                       | Bit 6              | Bit 5             | Bit 4                   | Bit 3                      | Bit 2            | Bit 1                       | Bit 0             | Reset          | RW   |     |
|-------|-----------------------|-------|-----------------------------|--------------------|-------------------|-------------------------|----------------------------|------------------|-----------------------------|-------------------|----------------|------|-----|
| 0x000 | SPI_INTFCONFA         | [7:0] | SOFTRESET_M                 | LSBFIRST_M         | ADDRINC_M         | SDOACTIVE_M             | SDOACTIVE                  | ADDRINC          | LSBFIRST                    | SOFTRESET         | 0x00           | R/W  |     |
| 0x001 | SPI_INTFCONFB         | [7:0] | SINGLEINS                   | CSSTALL            | RESERVED          |                         |                            | SOFTRESET1       | SOFTRESET0                  | RESERVED          | 0x00           | R/W  |     |
| 0x003 | SPI_CHIPTYPE          | [7:0] | CHIP_TYPE                   |                    |                   |                         |                            |                  |                             |                   |                | 0x00 | R   |
| 0x004 | SPI_PRODIDL           | [7:0] | PROD_ID[7:0]                |                    |                   |                         |                            |                  |                             |                   |                | 0x00 | R   |
| 0x005 | SPI_PRODIDH           | [7:0] | PROD_ID[15:8]               |                    |                   |                         |                            |                  |                             |                   |                | 0x00 | R   |
| 0x006 | SPI_CHIPGRADE         | [7:0] | PROD_GRADE                  |                    |                   |                         | DEV_REVISION               |                  |                             |                   | 0x00           | R    |     |
| 0x020 | IRQ_ENABLE            | [7:0] | RESERVED                    |                    |                   | EN_SYSREF_JITTER        | EN_DATA_READY              | EN_LANE_FIFO     | EN_PRBSQ                    | EN_PRBSI          | 0x00           | R/W  |     |
| 0x024 | IRQ_STATUS            | [7:0] | RESERVED                    |                    |                   | IRQ_SYSREF_JITTER       | IRQ_DATA_READY             | IRQ_LANE_FIFO    | IRQ_PRBSQ                   | IRQ_PRBSI         | 0x00           | R/W  |     |
| 0x031 | SYNC_LMFC_DELAY_FRAME | [7:0] | RESERVED                    |                    |                   | SYNC_LMFC_DELAY_SET_FRM |                            |                  |                             |                   | 0x00           | R/W  |     |
| 0x032 | SYNC_LMFC_DELAY0      | [7:0] | SYNC_LMFC_DELAY_SET[7:0]    |                    |                   |                         |                            |                  |                             |                   |                | 0x00 | R/W |
| 0x033 | SYNC_LMFC_DELAY1      | [7:0] | RESERVED                    |                    |                   |                         | SYNC_LMFC_DELAY_SET[11:8]  |                  |                             |                   | 0x00           | R/W  |     |
| 0x034 | SYNC_LMFC_STAT0       | [7:0] | SYNC_LMFC_DELAY_STAT[7:0]   |                    |                   |                         |                            |                  |                             |                   |                | 0x00 | R/W |
| 0x035 | SYNC_LMFC_STAT1       | [7:0] | RESERVED                    |                    |                   |                         | SYNC_LMFC_DELAY_STAT[11:8] |                  |                             |                   | 0x00           | R/W  |     |
| 0x036 | SYSREF_COUNT          | [7:0] | SYSREF_COUNT                |                    |                   |                         |                            |                  |                             |                   |                | 0x00 | R/W |
| 0x037 | SYSREF_PHASE0         | [7:0] | SYSREF_PHASE[7:0]           |                    |                   |                         |                            |                  |                             |                   |                | 0x00 | R/W |
| 0x038 | SYSREF_PHASE1         | [7:0] | RESERVED                    |                    |                   |                         | SYSREF_PHASE[11:8]         |                  |                             |                   | 0x00           | R/W  |     |
| 0x039 | SYSREF_JITTER_WINDOW  | [7:0] | RESERVED                    |                    |                   | SYSREF_JITTER_WINDOW    |                            |                  |                             |                   | 0x00           | R/W  |     |
| 0x03A | SYNC_CTRL             | [7:0] | RESERVED                    |                    |                   |                         |                            |                  | SYNC_MODE                   |                   |                | 0x00 | R/W |
| 0x03F | TX_ENABLE             | [7:0] | SPI_DATAPATH_POST           | SPI_DATAPATH_PRE   | RESERVED          |                         |                            | TXEN_NCO_RESET   | TXEN_DATAPATH_POST          | TXEN_DATAPATH_PRE | TXEN_DAC_FSC   | 0xC0 | R/W |
| 0x040 | ANA_DAC_BIAS_PD       | [7:0] | RESERVED                    |                    |                   |                         |                            |                  | ANA_DAC_BIAS_PD1            | ANA_DAC_BIAS_PDO  | 0x03           | R/W  |     |
| 0x041 | ANA_FSC0              | [7:0] | RESERVED                    |                    |                   |                         |                            |                  | ANA_FULL_SCALE_CURRENT[1:0] |                   |                | 0x03 | R/W |
| 0x042 | ANA_FSC1              | [7:0] | ANA_FULL_SCALE_CURRENT[9:2] |                    |                   |                         |                            |                  |                             |                   |                | 0xFF | R/W |
| 0x07F | CLK_PHASE_TUNE        | [7:0] | RESERVED                    |                    |                   | CLK_PHASE_TUNE          |                            |                  |                             |                   | 0x00           | R/W  |     |
| 0x080 | CLK_PD                | [7:0] | RESERVED                    |                    |                   |                         |                            |                  |                             |                   | DACCLK_PD      | 0x01 | R/W |
| 0x082 | CLK_DUTY              | [7:0] | CLK_DUTY_EN                 | CLK_DUTY_OFFSET_EN | CLK_DUTY_BOOST_EN | CLK_DUTY_PRG            |                            |                  |                             |                   | 0x80           | R/W  |     |
| 0x083 | CLK_CRS_CTRL          | [7:0] | CLK_CRS_EN                  | RESERVED           |                   |                         | CLK_CRS_ADJ                |                  |                             |                   | 0x80           | R/W  |     |
| 0x084 | PLL_REF_CLK_PD        | [7:0] | RESERVED                    |                    |                   | PLL_REF_CLK_RATE        |                            | RESERVED         |                             |                   | PLL_REF_CLK_PD | 0x00 | R/W |
| 0x088 | SYSREF_CTRL0          | [7:0] | RESERVED                    |                    |                   |                         | HYS_ON                     | SYSREF_RISE      | HYS_CNTRL[9:8]              |                   |                | 0x00 | R/W |
| 0x089 | SYSREF_CTRL1          | [7:0] | HYS_CNTRL[7:0]              |                    |                   |                         |                            |                  |                             |                   |                | 0x00 | R/W |
| 0x090 | DLL_PD                | [7:0] | RESERVED                    |                    |                   | DLL_FINE_DC_EN          | DLL_FINE_XC_EN             | DLL_COARSE_DC_EN | DLL_COARSE_XC_EN            | DLL_CLK_PD        |                | 0x1F | R/W |
| 0x091 | DLL_CTRL              | [7:0] | DLL_TRACK_ERR               | DLL_SEARCH_ERR     | DLL_SLOPE         | DLL_SEARCH              |                            | DLL_MODE         |                             | DLL_ENABLE        | 0xF0           | R/W  |     |
| 0x092 | DLL_STATUS            | [7:0] | RESERVED                    |                    |                   |                         |                            | DLL_FAIL         | DLL_LOST                    | DLL_LOCKED        |                | 0x00 | R/W |
| 0x093 | DLL_GB                | [7:0] | RESERVED                    |                    |                   |                         | DLL_GUARD                  |                  |                             |                   | 0x00           | R/W  |     |
| 0x094 | DLL_COARSE            | [7:0] | RESERVED                    |                    |                   | DLL_COARSE              |                            |                  |                             |                   | 0x00           | R/W  |     |
| 0x095 | DLL_FINE              | [7:0] | DLL_FINE                    |                    |                   |                         |                            |                  |                             |                   |                | 0x80 | R/W |
| 0x096 | DLL_PHASE             | [7:0] | RESERVED                    |                    |                   | DLL_PHS                 |                            |                  |                             |                   | 0x08           | R/W  |     |
| 0x097 | DLL_BW                | [7:0] | RESERVED                    |                    |                   | DLL_FILT_BW             |                            |                  | DLL_WEIGHT                  |                   | 0x00           | R/W  |     |
| 0x098 | DLL_READ              | [7:0] | RESERVED                    |                    |                   |                         |                            |                  |                             |                   | DLL_READ       | 0x00 | R/W |

| Reg.  | Name                     | Bits  | Bit 7                  | Bit 6        | Bit 5          | Bit 4       | Bit 3       | Bit 2             | Bit 1         | Bit 0            | Reset            | RW   |     |
|-------|--------------------------|-------|------------------------|--------------|----------------|-------------|-------------|-------------------|---------------|------------------|------------------|------|-----|
| 0x099 | DLL_COARSE_RB            | [7:0] | RESERVED               |              | DLL_COARSE_RB  |             |             |                   |               |                  | 0x00             | R    |     |
| 0x09A | DLL_FINE_RB              | [7:0] | DLL_FINE_RB            |              |                |             |             |                   | 0x00          | R                |                  |      |     |
| 0x09B | DLL_PHASE_RB             | [7:0] | RESERVED               |              |                | DLL_PHS_RB  |             |                   |               | 0x00             | R                |      |     |
| 0x09D | DIG_CLK_INVERT           | [7:0] | RESERVED               |              |                |             | INV_DIG_CLK | DIG_CLK_DC_EN     | DIG_CLK_XC_EN | 0x03             | R/W              |      |     |
| 0x0A0 | DLL_CLK_DEBUG            | [7:0] | DLL_TEST_EN            | RESERVED     |                |             |             | DLL_TEST_DIV      |               |                  | 0x00             | R/W  |     |
| 0x110 | INTERP_MODE              | [7:0] | JESD_LANES             |              |                | INTERP_MODE |             |                   |               | 0x81             | R/W              |      |     |
| 0x111 | DATAPATH_CFG             | [7:0] | INVSINC_EN             | NCO_EN       | RESERVED       | FILT_BW     | RESERVED    | MODULUS_EN        | SEL_SIDE BAND | FIR85_FILT_EN    | 0x00             | R/W  |     |
| 0x113 | FTW_UPDATE               | [7:0] | RESERVED               | FTW_REQ_MODE |                |             | RESERVED    | FTW_LOAD_SYSREF   | FTW_LOAD_ACK  | FTW_LOAD_REQ     | 0x00             | R/W  |     |
| 0x114 | FTW0                     | [7:0] | FTW[7:0]               |              |                |             |             |                   | 0x00          | R/W              |                  |      |     |
| 0x115 | FTW1                     | [7:0] | FTW[15:8]              |              |                |             |             |                   | 0x00          | R/W              |                  |      |     |
| 0x116 | FTW2                     | [7:0] | FTW[23:16]             |              |                |             |             |                   | 0x00          | R/W              |                  |      |     |
| 0x117 | FTW3                     | [7:0] | FTW[31:24]             |              |                |             |             |                   | 0x00          | R/W              |                  |      |     |
| 0x118 | FTW4                     | [7:0] | FTW[39:32]             |              |                |             |             |                   | 0x00          | R/W              |                  |      |     |
| 0x119 | FTW5                     | [7:0] | FTW[47:40]             |              |                |             |             |                   | 0x00          | R/W              |                  |      |     |
| 0x11C | PHASE_OFFSET0            | [7:0] | NCO_PHASE_OFFSET[7:0]  |              |                |             |             |                   | 0x00          | R/W              |                  |      |     |
| 0x11D | PHASE_OFFSET1            | [7:0] | NCO_PHASE_OFFSET[15:8] |              |                |             |             |                   | 0x00          | R/W              |                  |      |     |
| 0x124 | ACC_MODULUS0             | [7:0] | ACC_MODULUS[7:0]       |              |                |             |             |                   | 0x00          | R/W              |                  |      |     |
| 0x125 | ACC_MODULUS1             | [7:0] | ACC_MODULUS[15:8]      |              |                |             |             |                   | 0x00          | R/W              |                  |      |     |
| 0x126 | ACC_MODULUS2             | [7:0] | ACC_MODULUS[23:16]     |              |                |             |             |                   | 0x00          | R/W              |                  |      |     |
| 0x127 | ACC_MODULUS3             | [7:0] | ACC_MODULUS[31:24]     |              |                |             |             |                   | 0x00          | R/W              |                  |      |     |
| 0x128 | ACC_MODULUS4             | [7:0] | ACC_MODULUS[39:32]     |              |                |             |             |                   | 0x00          | R/W              |                  |      |     |
| 0x129 | ACC_MODULUS5             | [7:0] | ACC_MODULUS[47:40]     |              |                |             |             |                   | 0x00          | R/W              |                  |      |     |
| 0x12A | ACC_DELTA0               | [7:0] | ACC_DELTA[7:0]         |              |                |             |             |                   | 0x00          | R/W              |                  |      |     |
| 0x12B | ACC_DELTA1               | [7:0] | ACC_DELTA[15:8]        |              |                |             |             |                   | 0x00          | R/W              |                  |      |     |
| 0x12C | ACC_DELTA2               | [7:0] | ACC_DELTA[23:16]       |              |                |             |             |                   | 0x00          | R/W              |                  |      |     |
| 0x12D | ACC_DELTA3               | [7:0] | ACC_DELTA[31:24]       |              |                |             |             |                   | 0x00          | R/W              |                  |      |     |
| 0x12E | ACC_DELTA4               | [7:0] | ACC_DELTA[39:32]       |              |                |             |             |                   | 0x00          | R/W              |                  |      |     |
| 0x12F | ACC_DELTA5               | [7:0] | ACC_DELTA[47:40]       |              |                |             |             |                   | 0x00          | R/W              |                  |      |     |
| 0x132 | TEMP_SENS_LSB            | [7:0] | TEMP_SENS_OUT[7:0]     |              |                |             |             |                   | 0x00          | R                |                  |      |     |
| 0x133 | TEMP_SENS_MSB            | [7:0] | TEMP_SENS_OUT[15:8]    |              |                |             |             |                   | 0x00          | R                |                  |      |     |
| 0x134 | TEMP_SENS_UPDATE         | [7:0] | RESERVED               |              |                |             |             |                   |               |                  | TEMP_SENS_UPDATE | 0x00 | R/W |
| 0x135 | TEMP_SENS_CTRL           | [7:0] | TEMP_SENS_FAST         | RESERVED     |                |             |             |                   |               | TEMP_SENS_ENABLE | 0x20             | R/W  |     |
| 0x14B | PRBS                     | [7:0] | PRBS_GOOD_Q            | PRBS_GOOD_I  | RESERVED       | PRBS_INV_Q  | PRBS_INV_I  | PRBS_MODE         | PRBS_RESET    | PRBS_EN          | 0x10             | R/W  |     |
| 0x14C | PRBS_ERROR_I             | [7:0] | PRBS_COUNT_I           |              |                |             |             |                   | 0x00          | R                |                  |      |     |
| 0x14D | PRBS_ERROR_Q             | [7:0] | PRBS_COUNT_Q           |              |                |             |             |                   | 0x00          | R                |                  |      |     |
| 0x14E | TEST_DC_DATA1            | [7:0] | DC_TEST_DATA[15:8]     |              |                |             |             |                   | 0x00          | R/W              |                  |      |     |
| 0x14F | TEST_DC_DATA0            | [7:0] | DC_TEST_DATA[7:0]      |              |                |             |             |                   | 0x00          | R/W              |                  |      |     |
| 0x150 | DIG_TEST                 | [7:0] | RESERVED               |              |                |             |             |                   | DC_TEST_EN    | RESERVED         | 0x00             | R/W  |     |
| 0x151 | DECODE_CTRL              | [7:0] | RESERVED               |              |                |             | SHUFFLE_MSB | SHUFFLE_LSB       | SHUFFLE_DDR   | 0x01             | R/W              |      |     |
| 0x152 | DECODE_MODE              | [7:0] | RESERVED               |              |                |             |             |                   | DECODE_MODE   |                  | 0x00             | R/W  |     |
| 0x1DF | SPI_STRENGTH             | [7:0] | RESERVED               |              |                | SPIDRV      |             |                   |               | 0x0F             | R/W              |      |     |
| 0x200 | MASTER_PD                | [7:0] | RESERVED               |              |                |             |             |                   |               |                  | SPI_PD_MASTER    | 0x01 | R/W |
| 0x201 | PHY_PD                   | [7:0] | SPI_PD_PHY             |              |                |             |             |                   | 0x00          | R/W              |                  |      |     |
| 0x203 | GENERIC_PD               | [7:0] | RESERVED               |              |                |             |             |                   | SPI_SYNC1_PD  | RESERVED         | 0x00             | R/W  |     |
| 0x206 | CDR_RESET                | [7:0] | RESERVED               |              |                |             |             |                   |               |                  | SPI_CDR_RESET    | 0x01 | R/W |
| 0x230 | CDR_OPERATING_MODE_REG_0 | [7:0] | RESERVED               |              | SPI_ENHALFRATE | RESERVED    |             | SPI_DIVISION_RATE |               | RESERVED         | 0x28             | R/W  |     |

| Reg.  | Name                | Bits  | Bit 7                           | Bit 6           | Bit 5                     | Bit 4                    | Bit 3                    | Bit 2           | Bit 1                 | Bit 0                     | Reset | RW   |     |
|-------|---------------------|-------|---------------------------------|-----------------|---------------------------|--------------------------|--------------------------|-----------------|-----------------------|---------------------------|-------|------|-----|
| 0x250 | EQ_CONFIG_PHY_0_1   | [7:0] | SPI_EQ_CONFIG1                  |                 |                           |                          | SPI_EQ_CONFIG0           |                 |                       |                           | 0x88  | R/W  |     |
| 0x251 | EQ_CONFIG_PHY_2_3   | [7:0] | SPI_EQ_CONFIG3                  |                 |                           |                          | SPI_EQ_CONFIG2           |                 |                       |                           | 0x88  | R/W  |     |
| 0x252 | EQ_CONFIG_PHY_4_5   | [7:0] | SPI_EQ_CONFIG5                  |                 |                           |                          | SPI_EQ_CONFIG4           |                 |                       |                           | 0x88  | R/W  |     |
| 0x253 | EQ_CONFIG_PHY_6_7   | [7:0] | SPI_EQ_CONFIG7                  |                 |                           |                          | SPI_EQ_CONFIG6           |                 |                       |                           | 0x88  | R/W  |     |
| 0x268 | EQ_BIAS_REG         | [7:0] | EQ_POWER_MODE                   |                 | RESERVED                  |                          |                          |                 |                       |                           |       | 0x62 | R/W |
| 0x280 | SYNTH_ENABLE_CNTRL  | [7:0] | RESERVED                        |                 |                           |                          |                          | SPI_RECAL_SYNTH | RESERVED              | SPI_ENABLE_SYNTH          | 0x00  | R/W  |     |
| 0x281 | PLL_STATUS          | [7:0] | RESERVED                        |                 | SPI_CP_OVER_RANGE_HIGH_RB | SPI_CP_OVER_RANGE_LOW_RB | SPI_CP_CAL_VALID_RB      | RESERVED        |                       | SPI_PLL_LOCK_RB           | 0x00  | R    |     |
| 0x289 | REF_CLK_DIVIDER_LDO | [7:0] | RESERVED                        |                 |                           |                          |                          |                 | SERDES_PLL_DIV_FACTOR |                           | 0x04  | R/W  |     |
| 0x2A7 | TERM_BLK1_CTRLREG0  | [7:0] | RESERVED                        |                 |                           |                          |                          |                 |                       | SPI_I_TUNE_R_CAL_TERMBLK1 | 0x00  | R/W  |     |
| 0x2A8 | TERM_BLK1_CTRLREG1  | [7:0] | SPI_I_SERIALIZER_RTRIM_TERMBLK1 |                 |                           |                          |                          |                 |                       |                           |       | 0x00 | R/W |
| 0x2AC | TERM_BLK1_RD_REG0   | [7:0] | RESERVED                        |                 |                           |                          | SPI_O_RCAL_CODE_TERMBLK1 |                 |                       |                           | 0x00  | R    |     |
| 0x2AE | TERM_BLK2_CTRLREG0  | [7:0] | RESERVED                        |                 |                           |                          |                          |                 |                       | SPI_I_TUNE_R_CAL_TERMBLK2 | 0x00  | R/W  |     |
| 0x2AF | TERM_BLK2_CTRLREG1  | [7:0] | SPI_I_SERIALIZER_RTRIM_TERMBLK2 |                 |                           |                          |                          |                 |                       |                           |       | 0x00 | R/W |
| 0x2B3 | TERM_BLK2_RD_REG0   | [7:0] | RESERVED                        |                 |                           |                          | SPI_O_RCAL_CODE_TERMBLK2 |                 |                       |                           | 0x00  | R    |     |
| 0x2BB | TERM_OFFSET_0       | [7:0] | RESERVED                        |                 |                           |                          | TERM_OFFSET_0            |                 |                       |                           | 0x00  | R/W  |     |
| 0x2BC | TERM_OFFSET_1       | [7:0] | RESERVED                        |                 |                           |                          | TERM_OFFSET_1            |                 |                       |                           | 0x00  | R/W  |     |
| 0x2BD | TERM_OFFSET_2       | [7:0] | RESERVED                        |                 |                           |                          | TERM_OFFSET_2            |                 |                       |                           | 0x00  | R/W  |     |
| 0x2BE | TERM_OFFSET_3       | [7:0] | RESERVED                        |                 |                           |                          | TERM_OFFSET_3            |                 |                       |                           | 0x00  | R/W  |     |
| 0x2BF | TERM_OFFSET_4       | [7:0] | RESERVED                        |                 |                           |                          | TERM_OFFSET_4            |                 |                       |                           | 0x00  | R/W  |     |
| 0x2C0 | TERM_OFFSET_5       | [7:0] | RESERVED                        |                 |                           |                          | TERM_OFFSET_5            |                 |                       |                           | 0x00  | R/W  |     |
| 0x2C1 | TERM_OFFSET_6       | [7:0] | RESERVED                        |                 |                           |                          | TERM_OFFSET_6            |                 |                       |                           | 0x00  | R/W  |     |
| 0x2C2 | TERM_OFFSET_7       | [7:0] | RESERVED                        |                 |                           |                          | TERM_OFFSET_7            |                 |                       |                           | 0x00  | R/W  |     |
| 0x300 | GENERAL_JRX_CTRL_0  | [7:0] | RESERVED                        | CHECKSUM_MODE   | RESERVED                  |                          |                          |                 |                       | LINK_EN                   | 0x00  | R/W  |     |
| 0x302 | DYN_LINK_LATENCY_0  | [7:0] | RESERVED                        |                 |                           |                          | DYN_LINK_LATENCY_0       |                 |                       |                           | 0x00  | R    |     |
| 0x304 | LMFC_DELAY_0        | [7:0] | RESERVED                        |                 |                           |                          | LMFC_DELAY_0             |                 |                       |                           | 0x00  | R/W  |     |
| 0x306 | LMFC_VAR_0          | [7:0] | RESERVED                        |                 |                           |                          | LMFC_VAR_0               |                 |                       |                           | 0x1F  | R/W  |     |
| 0x308 | XBAR_LN_0_1         | [7:0] | RESERVED                        |                 | SRC_LANE1                 |                          | SRC_LANE0                |                 |                       | 0x08                      | R/W   |      |     |
| 0x309 | XBAR_LN_2_3         | [7:0] | RESERVED                        |                 | SRC_LANE3                 |                          | SRC_LANE2                |                 |                       | 0x1A                      | R/W   |      |     |
| 0x30A | XBAR_LN_4_5         | [7:0] | RESERVED                        |                 | SRC_LANE5                 |                          | SRC_LANE4                |                 |                       | 0x2C                      | R/W   |      |     |
| 0x30B | XBAR_LN_6_7         | [7:0] | RESERVED                        |                 | SRC_LANE7                 |                          | SRC_LANE6                |                 |                       | 0x3E                      | R/W   |      |     |
| 0x30C | FIFO_STATUS_REG_0   | [7:0] | LANE_FIFO_FULL                  |                 |                           |                          |                          |                 |                       |                           |       | 0x00 | R   |
| 0x30D | FIFO_STATUS_REG_1   | [7:0] | LANE_FIFO_EMPTY                 |                 |                           |                          |                          |                 |                       |                           |       | 0x00 | R   |
| 0x311 | SYNCH_GEN_0         | [7:0] | RESERVED                        |                 |                           |                          |                          | EOMF_MASK_0     | RESERVED              | EOF_MASK_0                | 0x00  | R/W  |     |
| 0x312 | SYNCH_GEN_1         | [7:0] | SYNCH_ERR_DUR                   |                 |                           |                          | SYNCH_SYNCREQ_DUR        |                 |                       |                           | 0x00  | R/W  |     |
| 0x313 | SYNCH_GEN_3         | [7:0] | LMFC_PERIOD                     |                 |                           |                          |                          |                 |                       |                           |       | 0x00 | R   |
| 0x315 | PHY_PRBS_TEST_EN    | [7:0] | PHY_TEST_EN                     |                 |                           |                          |                          |                 |                       |                           |       | 0x00 | R/W |
| 0x316 | PHY_PRBS_TEST_CTRL  | [7:0] | RESERVED                        | PHY_SRC_ERR_CNT |                           |                          | PHY_PRBS_PAT_SEL         |                 | PHY_TEST_START        | PHY_TEST_RESET            | 0x00  | R/W  |     |

| Reg.  | Name                            | Bits  | Bit 7                      | Bit 6     | Bit 5    | Bit 4             | Bit 3 | Bit 2 | Bit 1                | Bit 0             | Reset          | RW   |      |   |      |   |
|-------|---------------------------------|-------|----------------------------|-----------|----------|-------------------|-------|-------|----------------------|-------------------|----------------|------|------|---|------|---|
| 0x317 | PHY_PRBS_TEST_THRESHOLD_LOBITS  | [7:0] | PHY_PRBS_THRESHOLD_LOBITS  |           |          |                   |       |       |                      |                   |                | 0x00 | R/W  |   |      |   |
| 0x318 | PHY_PRBS_TEST_THRESHOLD_MIDBITS | [7:0] | PHY_PRBS_THRESHOLD_MIDBITS |           |          |                   |       |       |                      |                   |                | 0x00 | R/W  |   |      |   |
| 0x319 | PHY_PRBS_TEST_THRESHOLD_HIBITS  | [7:0] | PHY_PRBS_THRESHOLD_HIBITS  |           |          |                   |       |       |                      |                   |                | 0x00 | R/W  |   |      |   |
| 0x31A | PHY_PRBS_TEST_ERRCNT_LOBITS     | [7:0] | PHY_PRBS_ERR_CNT_LOBITS    |           |          |                   |       |       |                      |                   |                | 0x00 | R    |   |      |   |
| 0x31B | PHY_PRBS_TEST_ERRCNT_MIDBITS    | [7:0] | PHY_PRBS_ERR_CNT_MIDBITS   |           |          |                   |       |       |                      |                   |                | 0x00 | R    |   |      |   |
| 0x31C | PHY_PRBS_TEST_ERRCNT_HIBITS     | [7:0] | PHY_PRBS_ERR_CNT_HIBITS    |           |          |                   |       |       |                      |                   |                | 0x00 | R    |   |      |   |
| 0x31D | PHY_PRBS_TEST_STATUS            | [7:0] | PHY_PRBS_PASS              |           |          |                   |       |       |                      |                   |                | 0xFF | R    |   |      |   |
| 0x31E | PHY_DATA_SNAPSHOT_CTRL          | [7:0] | RESERVED                   |           |          | PHY_GRAB_LANE_SEL |       |       | PHY_GRAB_MODE        | PHY_GRAB_DATA     |                | 0x00 | R/W  |   |      |   |
| 0x31F | PHY_SNAPSHOT_DATA_BYTE0         | [7:0] | PHY_SNAPSHOT_DATA_BYTE0    |           |          |                   |       |       |                      |                   |                | 0x00 | R    |   |      |   |
| 0x320 | PHY_SNAPSHOT_DATA_BYTE1         | [7:0] | PHY_SNAPSHOT_DATA_BYTE1    |           |          |                   |       |       |                      |                   |                | 0x00 | R    |   |      |   |
| 0x321 | PHY_SNAPSHOT_DATA_BYTE2         | [7:0] | PHY_SNAPSHOT_DATA_BYTE2    |           |          |                   |       |       |                      |                   |                | 0x00 | R    |   |      |   |
| 0x322 | PHY_SNAPSHOT_DATA_BYTE3         | [7:0] | PHY_SNAPSHOT_DATA_BYTE3    |           |          |                   |       |       |                      |                   |                | 0x00 | R    |   |      |   |
| 0x323 | PHY_SNAPSHOT_DATA_BYTE4         | [7:0] | PHY_SNAPSHOT_DATA_BYTE4    |           |          |                   |       |       |                      |                   |                | 0x00 | R    |   |      |   |
| 0x32C | SHORT_TPL_TEST_0                | [7:0] | SHORT_TPL_SP_SEL           |           |          | SHORT_TPL_M_SEL   |       |       | SHORT_TPL_TEST_RESET | SHORT_TPL_TEST_EN |                | 0x00 | R/W  |   |      |   |
| 0x32D | SHORT_TPL_TEST_1                | [7:0] | SHORT_TPL_REF_SP_LSB       |           |          |                   |       |       |                      |                   |                | 0x00 | R/W  |   |      |   |
| 0x32E | SHORT_TPL_TEST_2                | [7:0] | SHORT_TPL_REF_SP_MSB       |           |          |                   |       |       |                      |                   |                | 0x00 | R/W  |   |      |   |
| 0x32F | SHORT_TPL_TEST_3                | [7:0] | RESERVED                   |           |          |                   |       |       |                      |                   | SHORT_TPL_FAIL | 0x00 | R    |   |      |   |
| 0x334 | JESD_BIT_INVERSE_CTRL           | [7:0] | JESD_BIT_INVERSE           |           |          |                   |       |       |                      |                   |                | 0x00 | R/W  |   |      |   |
| 0x400 | DID_REG                         | [7:0] | DID_RD                     |           |          |                   |       |       |                      |                   |                | 0x00 | R    |   |      |   |
| 0x401 | BID_REG                         | [7:0] | BID_RD                     |           |          |                   |       |       |                      |                   |                | 0x00 | R    |   |      |   |
| 0x402 | LID0_REG                        | [7:0] | RESERVED                   | ADJDIR_RD | PHADJ_RD | LL_LID0           |       |       |                      |                   |                | 0x00 | R    |   |      |   |
| 0x403 | SCR_L_REG                       | [7:0] | SCR_RD                     | RESERVED  |          |                   | L_RD  |       |                      |                   |                |      | 0x00 | R |      |   |
| 0x404 | F_REG                           | [7:0] | F_RD                       |           |          |                   |       |       |                      |                   |                | 0x00 | R    |   |      |   |
| 0x405 | K_REG                           | [7:0] | RESERVED                   |           |          |                   |       |       | K_RD                 |                   |                |      |      |   | 0x00 | R |
| 0x406 | M_REG                           | [7:0] | M_RD                       |           |          |                   |       |       |                      |                   |                | 0x00 | R    |   |      |   |
| 0x407 | CS_N_REG                        | [7:0] | CS_RD                      |           |          | RESERVED          |       |       | N_RD                 |                   |                |      |      |   | 0x00 | R |
| 0x408 | NP_REG                          | [7:0] | SUBCLASSV_RD               |           |          |                   |       |       | NP_RD                |                   |                |      |      |   | 0x00 | R |
| 0x409 | S_REG                           | [7:0] | JESDV_RD                   |           |          |                   |       |       | S_RD                 |                   |                |      |      |   | 0x00 | R |
| 0x40A | HD_CF_REG                       | [7:0] | HD_RD                      | RESERVED  |          |                   | CF_RD |       |                      |                   |                |      | 0x00 | R |      |   |
| 0x40B | RES1_REG                        | [7:0] | RES1_RD                    |           |          |                   |       |       |                      |                   |                | 0x00 | R    |   |      |   |
| 0x40C | RES2_REG                        | [7:0] | RES2_RD                    |           |          |                   |       |       |                      |                   |                | 0x00 | R    |   |      |   |
| 0x40D | CHECKSUM0_REG                   | [7:0] | LL_FCHK0                   |           |          |                   |       |       |                      |                   |                | 0x00 | R    |   |      |   |
| 0x40E | COMPSUM0_REG                    | [7:0] | LL_FCMP0                   |           |          |                   |       |       |                      |                   |                | 0x00 | R    |   |      |   |
| 0x412 | LID1_REG                        | [7:0] | RESERVED                   |           |          |                   |       |       | LL_LID1              |                   |                |      |      |   | 0x00 | R |
| 0x415 | CHECKSUM1_REG                   | [7:0] | LL_FCHK1                   |           |          |                   |       |       |                      |                   |                | 0x00 | R    |   |      |   |
| 0x416 | COMPSUM1_REG                    | [7:0] | LL_FCMP1                   |           |          |                   |       |       |                      |                   |                | 0x00 | R    |   |      |   |
| 0x41A | LID2_REG                        | [7:0] | RESERVED                   |           |          |                   |       |       | LL_LID2              |                   |                |      |      |   | 0x00 | R |

| Reg.  | Name             | Bits  | Bit 7     | Bit 6         | Bit 5     | Bit 4      | Bit 3      | Bit 2            | Bit 1    | Bit 0        | Reset | RW   |      |     |
|-------|------------------|-------|-----------|---------------|-----------|------------|------------|------------------|----------|--------------|-------|------|------|-----|
| 0x41D | CHECKSUM2_REG    | [7:0] | LL_FCHK2  |               |           |            |            |                  |          |              |       | 0x00 | R    |     |
| 0x41E | COMPNUM2_REG     | [7:0] | LL_FCMP2  |               |           |            |            |                  |          |              |       | 0x00 | R    |     |
| 0x422 | LID3_REG         | [7:0] | RESERVED  |               |           | LL_LID3    |            |                  |          |              |       | 0x00 | R    |     |
| 0x425 | CHECKSUM3_REG    | [7:0] | LL_FCHK3  |               |           |            |            |                  |          |              |       | 0x00 | R    |     |
| 0x426 | COMPNUM3_REG     | [7:0] | LL_FCMP3  |               |           |            |            |                  |          |              |       | 0x00 | R    |     |
| 0x42A | LID4_REG         | [7:0] | RESERVED  |               |           | LL_LID4    |            |                  |          |              |       | 0x00 | R    |     |
| 0x42D | CHECKSUM4_REG    | [7:0] | LL_FCHK4  |               |           |            |            |                  |          |              |       | 0x00 | R    |     |
| 0x42E | COMPNUM4_REG     | [7:0] | LL_FCMP4  |               |           |            |            |                  |          |              |       | 0x00 | R    |     |
| 0x432 | LID5_REG         | [7:0] | RESERVED  |               |           | LL_LID5    |            |                  |          |              |       | 0x00 | R    |     |
| 0x435 | CHECKSUM5_REG    | [7:0] | LL_FCHK5  |               |           |            |            |                  |          |              |       | 0x00 | R    |     |
| 0x436 | COMPNUM5_REG     | [7:0] | LL_FCMP5  |               |           |            |            |                  |          |              |       | 0x00 | R    |     |
| 0x43A | LID6_REG         | [7:0] | RESERVED  |               |           | LL_LID6    |            |                  |          |              |       | 0x00 | R    |     |
| 0x43D | CHECKSUM6_REG    | [7:0] | LL_FCHK6  |               |           |            |            |                  |          |              |       | 0x00 | R    |     |
| 0x43E | COMPNUM6_REG     | [7:0] | LL_FCMP6  |               |           |            |            |                  |          |              |       | 0x00 | R    |     |
| 0x442 | LID7_REG         | [7:0] | RESERVED  |               |           | LL_LID7    |            |                  |          |              |       | 0x00 | R    |     |
| 0x445 | CHECKSUM7_REG    | [7:0] | LL_FCHK7  |               |           |            |            |                  |          |              |       | 0x00 | R    |     |
| 0x446 | COMPNUM7_REG     | [7:0] | LL_FCMP7  |               |           |            |            |                  |          |              |       | 0x00 | R    |     |
| 0x450 | ILS_DID          | [7:0] | DID       |               |           |            |            |                  |          |              |       | 0x00 | R/W  |     |
| 0x451 | ILS_BID          | [7:0] | BID       |               |           |            |            |                  |          |              |       | 0x00 | R/W  |     |
| 0x452 | ILS_LID0         | [7:0] | RESERVED  | ADJDIR        | PHADJ     | LID0       |            |                  |          |              |       | 0x00 | R/W  |     |
| 0x453 | ILS_SCR_L        | [7:0] | SCR       | RESERVED      |           |            | L          |                  |          |              |       | 0x87 | R/W  |     |
| 0x454 | ILS_F            | [7:0] | F         |               |           |            |            |                  |          |              |       | 0x00 | R    |     |
| 0x455 | ILS_K            | [7:0] | RESERVED  |               |           | K          |            |                  |          |              |       | 0x1F | R/W  |     |
| 0x456 | ILS_M            | [7:0] | M         |               |           |            |            |                  |          |              |       | 0x01 | R    |     |
| 0x457 | ILS_CS_N         | [7:0] | CS        |               | RESERVED  |            | N          |                  |          |              |       | 0x0F | R    |     |
| 0x458 | ILS_NP           | [7:0] | SUBCLASSV |               |           |            | NP         |                  |          |              |       | 0x0F | R/W  |     |
| 0x459 | ILS_S            | [7:0] | JESDV     |               |           |            | S          |                  |          |              |       | 0x01 | R/W  |     |
| 0x45A | ILS_HD_CF        | [7:0] | HD        | RESERVED      |           |            | CF         |                  |          |              |       | 0x80 | R    |     |
| 0x45B | ILS_RES1         | [7:0] | RES1      |               |           |            |            |                  |          |              |       | 0x00 | R/W  |     |
| 0x45C | ILS_RES2         | [7:0] | RES2      |               |           |            |            |                  |          |              |       | 0x00 | R/W  |     |
| 0x45D | ILS_CHECKSUM     | [7:0] | FCHK0     |               |           |            |            |                  |          |              |       | 0x00 | R/W  |     |
| 0x46C | LANE_DESKEW      | [7:0] | ILD7      | ILS6          | ILD5      | ILD4       | ILD3       | ILD2             | ILD1     | ILD0         |       | 0x00 | R    |     |
| 0x46D | BAD_DISPARITY    | [7:0] | BDE7      | BDE6          | BDE5      | BDE4       | BDE3       | BDE2             | BDE1     | BDE0         |       | 0x00 | R    |     |
| 0x46E | NOT_IN_TABLE     | [7:0] | NIT7      | NIT6          | NIT5      | NIT4       | NIT3       | NIT2             | NIT1     | NIT0         |       | 0x00 | R    |     |
| 0x46F | UNEXPECTED_KCHAR | [7:0] | UEK7      | UEK6          | UEK5      | UEK4       | UEK3       | UEK2             | UEK1     | UEK0         |       | 0x00 | R    |     |
| 0x470 | CODE_GRP_SYNC    | [7:0] | CGS7      | CGS6          | CGS5      | CGS4       | CGS3       | CGS2             | CGS1     | CGS0         |       | 0x00 | R    |     |
| 0x471 | FRAME_SYNC       | [7:0] | FS7       | FS6           | FS5       | FS4        | FS3        | FS2              | FS1      | FS0          |       | 0x00 | R    |     |
| 0x472 | GOOD_CHECKSUM    | [7:0] | CKS7      | CKS6          | CKS5      | CKS4       | CKS3       | CKS2             | CKS1     | CKS0         |       | 0x00 | R    |     |
| 0x473 | INIT_LANE_SYNC   | [7:0] | ILS7      | ILS6          | ILS5      | ILS4       | ILS3       | ILS2             | ILS1     | ILS0         |       | 0x00 | R    |     |
| 0x475 | CTRLREG0         | [7:0] | RX_DIS    | CHAR_REPL_DIS | RESERVED  |            | SOFTTRST   | FORCESYNCREQ     | RESERVED | REPL_FRM_ENA |       | 0x01 | R/W  |     |
| 0x476 | CTRLREG1         | [7:0] | RESERVED  |               |           | QUAL_RDERR | DEL_SCR    | CGS_SEL          | NO_ILAS  | FCHK_N       |       | 0x14 | R/W  |     |
| 0x477 | CTRLREG2         | [7:0] | ILS_MODE  | RESERVED      | REPDATEST | QUETESTERR | AR_ECNTNTR | RESERVED         |          |              |       | 0x00 | R/W  |     |
| 0x478 | KVAL             | [7:0] | KSYNC     |               |           |            |            |                  |          |              |       | 0x01 | R/W  |     |
| 0x47C | ERRORTHRES       | [7:0] | ETH       |               |           |            |            |                  |          |              |       | 0xFF | R/W  |     |
| 0x47D | SYNC_ASSERT_MASK | [7:0] | RESERVED  |               |           |            |            | SYNC_ASSERT_MASK |          |              |       |      | 0x07 | R/W |
| 0x480 | ECNT_CTRL0       | [7:0] | RESERVED  |               |           | ECNT_ENA0  |            | ECNT_RST0        |          |              |       | 0x3F | R/W  |     |
| 0x481 | ECNT_CTRL1       | [7:0] | RESERVED  |               |           | ECNT_ENA1  |            | ECNT_RST1        |          |              |       | 0x3F | R/W  |     |
| 0x482 | ECNT_CTRL2       | [7:0] | RESERVED  |               |           | ECNT_ENA2  |            | ECNT_RST2        |          |              |       | 0x3F | R/W  |     |



| Reg.  | Name         | Bits  | Bit 7    | Bit 6 | Bit 5 | Bit 4     | Bit 3 | Bit 2     | Bit 1 | Bit 0 | Reset | RW  |
|-------|--------------|-------|----------|-------|-------|-----------|-------|-----------|-------|-------|-------|-----|
| 0x483 | ECNT_CTRL3   | [7:0] | RESERVED |       |       | ECNT_ENA3 |       | ECNT_RST3 |       |       | 0x3F  | R/W |
| 0x484 | ECNT_CTRL4   | [7:0] | RESERVED |       |       | ECNT_ENA4 |       | ECNT_RST4 |       |       | 0x3F  | R/W |
| 0x485 | ECNT_CTRL5   | [7:0] | RESERVED |       |       | ECNT_ENA5 |       | ECNT_RST5 |       |       | 0x3F  | R/W |
| 0x486 | ECNT_CTRL6   | [7:0] | RESERVED |       |       | ECNT_ENA6 |       | ECNT_RST6 |       |       | 0x3F  | R/W |
| 0x487 | ECNT_CTRL7   | [7:0] | RESERVED |       |       | ECNT_ENA7 |       | ECNT_RST7 |       |       | 0x3F  | R/W |
| 0x488 | ECNT_TCH0    | [7:0] | RESERVED |       |       |           |       | ECNT_TCH0 |       |       | 0x07  | R/W |
| 0x489 | ECNT_TCH1    | [7:0] | RESERVED |       |       |           |       | ECNT_TCH1 |       |       | 0x07  | R/W |
| 0x48A | ECNT_TCH2    | [7:0] | RESERVED |       |       |           |       | ECNT_TCH2 |       |       | 0x07  | R/W |
| 0x48B | ECNT_TCH3    | [7:0] | RESERVED |       |       |           |       | ECNT_TCH3 |       |       | 0x07  | R/W |
| 0x48C | ECNT_TCH4    | [7:0] | RESERVED |       |       |           |       | ECNT_TCH4 |       |       | 0x07  | R/W |
| 0x48D | ECNT_TCH5    | [7:0] | RESERVED |       |       |           |       | ECNT_TCH5 |       |       | 0x07  | R/W |
| 0x48E | ECNT_TCH6    | [7:0] | RESERVED |       |       |           |       | ECNT_TCH6 |       |       | 0x07  | R/W |
| 0x48F | ECNT_TCH7    | [7:0] | RESERVED |       |       |           |       | ECNT_TCH7 |       |       | 0x07  | R/W |
| 0x490 | ECNT_STAT0   | [7:0] | RESERVED |       |       | LANE_ENA0 |       | ECNT_TCR0 |       |       | 0x00  | R   |
| 0x491 | ECNT_STAT1   | [7:0] | RESERVED |       |       | LANE_ENA1 |       | ECNT_TCR1 |       |       | 0x00  | R   |
| 0x492 | ECNT_STAT2   | [7:0] | RESERVED |       |       | LANE_ENA2 |       | ECNT_TCR2 |       |       | 0x00  | R   |
| 0x493 | ECNT_STAT3   | [7:0] | RESERVED |       |       | LANE_ENA3 |       | ECNT_TCR3 |       |       | 0x00  | R   |
| 0x494 | ECNT_STAT4   | [7:0] | RESERVED |       |       | LANE_ENA4 |       | ECNT_TCR4 |       |       | 0x00  | R   |
| 0x495 | ECNT_STAT5   | [7:0] | RESERVED |       |       | LANE_ENA5 |       | ECNT_TCR5 |       |       | 0x00  | R   |
| 0x496 | ECNT_STAT6   | [7:0] | RESERVED |       |       | LANE_ENA6 |       | ECNT_TCR6 |       |       | 0x00  | R   |
| 0x497 | ECNT_STAT7   | [7:0] | RESERVED |       |       | LANE_ENA7 |       | ECNT_TCR7 |       |       | 0x00  | R   |
| 0x498 | BD_CNT0      | [7:0] | BD_CNT0  |       |       |           |       |           |       |       | 0x00  | R   |
| 0x499 | BD_CNT1      | [7:0] | BD_CNT1  |       |       |           |       |           |       |       | 0x00  | R   |
| 0x49A | BD_CNT2      | [7:0] | BD_CNT2  |       |       |           |       |           |       |       | 0x00  | R   |
| 0x49B | BD_CNT3      | [7:0] | BD_CNT3  |       |       |           |       |           |       |       | 0x00  | R   |
| 0x49C | BD_CNT4      | [7:0] | BD_CNT4  |       |       |           |       |           |       |       | 0x00  | R   |
| 0x49D | BD_CNT5      | [7:0] | BD_CNT5  |       |       |           |       |           |       |       | 0x00  | R   |
| 0x49E | BD_CNT6      | [7:0] | BD_CNT6  |       |       |           |       |           |       |       | 0x00  | R   |
| 0x49F | BD_CNT7      | [7:0] | BD_CNT7  |       |       |           |       |           |       |       | 0x00  | R   |
| 0x4A0 | NIT_CNT0     | [7:0] | NIT_CNT0 |       |       |           |       |           |       |       | 0x00  | R   |
| 0x4A1 | NIT_CNT1     | [7:0] | NIT_CNT1 |       |       |           |       |           |       |       | 0x00  | R   |
| 0x4A2 | NIT_CNT2     | [7:0] | NIT_CNT2 |       |       |           |       |           |       |       | 0x00  | R   |
| 0x4A3 | NIT_CNT3     | [7:0] | NIT_CNT3 |       |       |           |       |           |       |       | 0x00  | R   |
| 0x4A4 | NIT_CNT4     | [7:0] | NIT_CNT4 |       |       |           |       |           |       |       | 0x00  | R   |
| 0x4A5 | NIT_CNT5     | [7:0] | NIT_CNT5 |       |       |           |       |           |       |       | 0x00  | R   |
| 0x4A6 | NIT_CNT6     | [7:0] | NIT_CNT6 |       |       |           |       |           |       |       | 0x00  | R   |
| 0x4A7 | NIT_CNT7     | [7:0] | NIT_CNT7 |       |       |           |       |           |       |       | 0x00  | R   |
| 0x4A8 | UEK_CNT0     | [7:0] | UEK_CNT0 |       |       |           |       |           |       |       | 0x00  | R   |
| 0x4A9 | UEK_CNT1     | [7:0] | UEK_CNT1 |       |       |           |       |           |       |       | 0x00  | R   |
| 0x4AA | UEK_CNT2     | [7:0] | UEK_CNT2 |       |       |           |       |           |       |       | 0x00  | R   |
| 0x4AB | UEK_CNT3     | [7:0] | UEK_CNT3 |       |       |           |       |           |       |       | 0x00  | R   |
| 0x4AC | UEK_CNT4     | [7:0] | UEK_CNT4 |       |       |           |       |           |       |       | 0x00  | R   |
| 0x4AD | UEK_CNT5     | [7:0] | UEK_CNT5 |       |       |           |       |           |       |       | 0x00  | R   |
| 0x4AE | UEK_CNT6     | [7:0] | UEK_CNT6 |       |       |           |       |           |       |       | 0x00  | R   |
| 0x4AF | UEK_CNT7     | [7:0] | UEK_CNT7 |       |       |           |       |           |       |       | 0x00  | R   |
| 0x4B0 | LINK_STATUS0 | [7:0] | BDE0     | NIT0  | UEK0  | ILD0      | ILS0  | CKS0      | FS0   | CGS0  | 0x00  | R   |
| 0x4B1 | LINK_STATUS1 | [7:0] | BDE1     | NIT1  | UEK1  | ILD1      | ILS1  | CKS1      | FS1   | CGS1  | 0x00  | R   |
| 0x4B2 | LINK_STATUS2 | [7:0] | BDE2     | NIT2  | UEK2  | ILD2      | ILS2  | CKS2      | FS2   | CGS2  | 0x00  | R   |
| 0x4B3 | LINK_STATUS3 | [7:0] | BDE3     | NIT3  | UEK3  | ILD3      | ILS3  | CKS3      | FS3   | CGS3  | 0x00  | R   |
| 0x4B4 | LINK_STATUS4 | [7:0] | BDE4     | NIT4  | UEK4  | ILD4      | ILS4  | CKS4      | FS4   | CGS4  | 0x00  | R   |

| Reg.  | Name             | Bits  | Bit 7     | Bit 6   | Bit 5    | Bit 4   | Bit 3   | Bit 2   | Bit 1  | Bit 0    | Reset | RW  |
|-------|------------------|-------|-----------|---------|----------|---------|---------|---------|--------|----------|-------|-----|
| 0x4B5 | LINK_STATUS5     | [7:0] | BDE5      | NIT5    | UEK5     | ILD5    | ILS5    | CKS5    | FS5    | CGS5     | 0x00  | R   |
| 0x4B6 | LINK_STATUS6     | [7:0] | BDE6      | NIT6    | UEK6     | ILD6    | ILS6    | CKS6    | FS6    | CGS6     | 0x00  | R   |
| 0x4B7 | LINK_STATUS7     | [7:0] | BDE7      | NIT7    | UEK7     | ILD7    | ILS7    | CKS7    | FS7    | CGS7     | 0x00  | R   |
| 0x4B8 | JESD_IRQ_ENABLEA | [7:0] | EN_BDE    | EN_NIT  | EN_UEK   | EN_ILD  | EN_ILS  | EN_CKS  | EN_FS  | EN_CGS   | 0x00  | R/W |
| 0x4B9 | JESD_IRQ_ENABLEB | [7:0] | RESERVED  |         |          |         |         |         |        | EN_ILAS  | 0x00  | R/W |
| 0x4BA | JESD_IRQ_STATUSA | [7:0] | IRQ_BDE   | IRQ_NIT | IRQ_UEK  | IRQ_ILD | IRQ_ILS | IRQ_CKS | IRQ_FS | IRQ_CGS  | 0x00  | R/W |
| 0x4BB | JESD_IRQ_STATUSB | [7:0] | RESERVED  |         |          |         |         |         |        | IRQ_ILAS | 0x00  | R/W |
| 0x800 | HOPF_CTRL        | [7:0] | HOPF_MODE |         | RESERVED |         |         |         |        |          | 0x00  | R/W |

## REGISTER DETAILS

Table 46. Register Details

| Hex. Addr. | Name          | Bits  | Bit Name              | Settings | Description   | Reset | Access |
|------------|---------------|-------|-----------------------|----------|---|-------|--------|
| 0x000      | SPI_INTFCONFA | 7     | SOFTRESET_M           |          | Soft reset (mirror). Set this to mirror Bit 0.  | 0x0   | R      |
|            |               | 6     | LSBFIRST_M            |          | LSB first (mirror). Set this to mirror Bit 1.   | 0x0   | R      |
|            |               | 5     | ADDRINC_M             |          | Addr increment (mirror). Set this to mirror Bit 2.  | 0x0   | R      |
|            |               | 4     | SDOACTIVE_M           |          | SDO active (mirror). Set this to mirror Bit 3.  | 0x0   | R      |
|            |               | 3     | SDOACTIVE             |          | SDO active. Enables 4-wire SPI bus mode.  | 0x0   | R/W    |
|            |               | 2     | ADDRINC               |          | Address increment. When set, causes incrementing streaming addresses; otherwise, descending addresses are generated.<br><br>1 Streaming addresses are incremented.<br>0 Streaming addresses are decremented.  | 0x0   | R/W    |
|            |               | 1     | LSBFIRST              |          | LSB first. When set, causes input and output data to be oriented as LSB first. If this bit is clear, data is oriented as MSB first.<br><br>1 Shift LSB in first.<br>0 Shift MSB in first.   | 0x0   | R/W    |
| 0x001      | SPI_INTFCONFB | 0     | SOFTRESET             |          | Soft reset. This bit automatically clears to 0 after performing a reset operation. Setting this bit initiates a reset. This bit is autoclearing after the soft reset is complete.<br><br>1 Pulse the soft reset line.<br>0 Reset the soft reset line. | 0x0   | R/W    |
|            |               | 7     | SINGLEINS             |          | Single instruction.<br><br>1 Perform single transfers.<br>0 Perform multiple transfers.   | 0x0   | R/W    |
|            |               | 6     | $\overline{CS}$ STALL |          | $\overline{CS}$ stalling.<br><br>0 Disable $\overline{CS}$ stalling.<br>1 Enable $\overline{CS}$ stalling.  | 0x0   | R/W    |
|            |               | [5:3] | RESERVED              |          | Reserved.   | 0x0   | R/W    |
|            |               | 2     | SOFTRESET1            |          | Soft Reset 1. This bit automatically clears to 0 after performing a reset operation.<br><br>1 Pulse the Soft Reset 1 line.<br>0 Pulse the Soft Reset 1 line.  | 0x0   | R/W    |
|            |               | 1     | SOFTRESET0            |          | Soft Reset 0. This bit automatically clears to 0 after performing a reset operation.<br><br>1 Pulse the Soft Reset 0 line.<br>0 Pulse the Soft Reset 0 line.  | 0x0   | R/W    |
|            |               | 0     | RESERVED              |          | Reserved.   | 0x0   | R      |
| 0x003      | SPI_CHIPTYPE  | [7:0] | CHIP_TYPE             |          | Chip type.  | 0x0   | R      |
| 0x004      | SPI_PRODIDL   | [7:0] | PROD_ID[7:0]          |          | Product ID.   | 0x0   | R      |
| 0x005      | SPI_PRODIDH   | [7:0] | PROD_ID[15:8]         |          | Product ID.   | 0x0   | R      |

| Hex. Addr. | Name                  | Bits  | Bit Name                  | Settings | Description   | Reset | Access |
|------------|-----------------------|-------|---------------------------|----------|---|-------|--------|
| 0x006      | SPI_CHIPGRADE         | [7:4] | PROD_GRADE                |          | Product grade.  | 0x0   | R      |
|            |                       | [3:0] | DEV_REVISION              |          | Device revision.  | 0x0   | R      |
| 0x020      | IRQ_ENABLE            | [7:5] | RESERVED                  |          | Reserved.   | 0x0   | R      |
|            |                       | 4     | EN_SYSREF_JITTER          | 0<br>1   | Enable SYSREF± jitter interrupt.<br>Disable interrupt.<br>Enable interrupt.                               | 0x0   | R/W    |
|            |                       | 3     | EN_DATA_READY             | 0<br>1   | Enable JESD204x receiver ready (JRX_DATA_READY) low interrupt.<br>Disable interrupt.<br>Enable interrupt. | 0x0   | R/W    |
|            |                       | 2     | EN_LANE_FIFO              | 0<br>1   | Enable lane FIFO overflow/underflow interrupt.<br>Disable interrupt.<br>Enable interrupt.                 | 0x0   | R/W    |
|            |                       | 1     | EN_PRBSQ                  | 0<br>1   | Enable PRBS imaginary error interrupt.<br>Disable interrupt.<br>Enable interrupt.                         | 0x0   | R/W    |
|            |                       | 0     | EN_PRBSI                  | 0<br>1   | Enable PRBS real error interrupt.<br>Disable interrupt.<br>Enable interrupt.                              | 0x0   | R/W    |
| 0x024      | IRQ_STATUS            | [7:5] | RESERVED                  |          | Reserved.   | 0x0   | R      |
|            |                       | 4     | IRQ_SYSREF_JITTER         |          | SYSREF± jitter is too big. Writing 1 clears the status.   | 0x0   | R/W    |
|            |                       | 3     | IRQ_DATA_READY            | 0<br>1   | JRX_DATA_READY is low. Writing 1 clears the status.<br>No warning.<br>Warning detected.                   | 0x0   | R/W    |
|            |                       | 2     | IRQ_LANE_FIFO             | 0<br>1   | Lane FIFO overflow/underflow. Writing 1 clears the status.<br>No warning.<br>Warning detected.            | 0x0   | R/W    |
|            |                       | 1     | IRQ_PRBSQ                 | 0<br>1   | PRBS imaginary error. Writing 1 clears the status.<br>No warning.<br>Warning detected.                    | 0x0   | R/W    |
|            |                       | 0     | IRQ_PRBSI                 | 0<br>1   | PRBS real error. Writing 1 clears the status.<br>No warning.<br>Warning detected.                         | 0x0   | R/W    |
| 0x031      | SYNC_LMFC_DELAY_FRAME | [7:5] | RESERVED                  |          | Reserved.   | 0x0   | R      |
|            |                       | [4:0] | SYNC_LMFC_DELAY_SET_FRM   |          | Desired delay from rising edge of SYSREF± input to rising edge of LMFC in frames.                         | 0x0   | R/W    |
| 0x032      | SYNC_LMFC_DELAY0      | [7:0] | SYNC_LMFC_DELAY_SET[7:0]  |          | Desired delay from rising edge of SYSREF± input to rising edge of LMFC in DAC clock units.                | 0x0   | R/W    |
| 0x033      | SYNC_LMFC_DELAY1      | [7:4] | RESERVED                  |          | Reserved.   | 0x0   | R      |
|            |                       | [3:0] | SYNC_LMFC_DELAY_SET[11:8] |          | Desired delay from rising edge of SYSREF± input to rising edge of LMFC in DAC clock units.                | 0x0   | R/W    |

| Hex. Addr. | Name                 | Bits  | Bit Name                   | Settings | Description   | Reset | Access |
|------------|----------------------|-------|----------------------------|----------|---|-------|--------|
| 0x034      | SYNC_LMFC_STAT0      | [7:0] | SYNC_LMFC_DELAY_STAT[7:0]  |          | Measured delay from rising edge of SYSREF± input to rising edge of LMFC in DAC clock units (note: 2 LSBs are always zero). A write to SYNC_LMFC_STATx or SYSREF_PHASEx saves the data for readback.   | 0x0   | R/W    |
| 0x035      | SYNC_LMFC_STAT1      | [7:4] | RESERVED                   |          | Reserved.   | 0x0   | R      |
|            |                      | [3:0] | SYNC_LMFC_DELAY_STAT[11:8] |          | Measured delay from rising edge of SYSREF± input to rising edge of LMFC in DAC clock units (note: 2 LSBs are always zero). A write to SYNC_LMFC_STATx or SYSREF_PHASEx saves the data for readback.   | 0x0   | R/W    |
| 0x036      | SYSREF_COUNT         | [7:0] | SYSREF_COUNT               |          | Count of SYSREF± signals received. A write resets the count. A write to SYNC_LMFC_STATx or SYSREF_PHASEx saves the data for readback.   | 0x0   | R/W    |
| 0x037      | SYSREF_PHASE0        | [7:0] | SYSREF_PHASE[7:0]          |          | Phase of measured SYSREF± event. Thermometer encoded. A write to SYNC_LMFC_STATx or SYSREF_PHASEx saves the data for readback.  | 0x0   | R/W    |
| 0x038      | SYSREF_PHASE1        | [7:4] | RESERVED                   |          | Reserved.   | 0x0   | R      |
|            |                      | [3:0] | SYSREF_PHASE[11:8]         |          | Phase of measured SYSREF± event. Thermometer encoded. A write to SYNC_LMFC_STATx or SYSREF_PHASEx saves the data for readback.  | 0x0   | R/W    |
| 0x039      | SYSREF_JITTER_WINDOW | [7:6] | RESERVED                   |          | Reserved.   | 0x0   | R      |
|            |                      | [5:0] | SYSREF_JITTER_WINDOW       |          | Amount of jitter allowed on the SYSREF± input. SYSREF± jitter variations bigger than this triggers an interrupt. Units are in DAC clocks. The bottom two bits are ignored.  | 0x0   | R/W    |
| 0x03A      | SYNC_CTRL            | [7:2] | RESERVED                   |          | Reserved.   | 0x0   | R      |
|            |                      | [1:0] | SYNC_MODE                  |          | Synchronization mode.<br>00 Do not perform synchronization, monitor SYSREF± to LMFC delay only.<br>01 Perform continuous synchronization of LMFC on every SYSREF±.<br>10 Perform a single synchronization on the next SYSREF±, then switch to monitor mode. | 0x0   | R/W    |
| 0x03F      | TX_ENABLE            | 7     | SPI_DATAPATH_POST          |          | SPI control of the data at the output of the datapath.<br>0 Disable or zero the data from the datapath into the DAC.<br>1 Use the data from the datapath to drive the DAC.  | 0x1   | R/W    |

| Hex. Addr. | Name            | Bits  | Bit Name                    | Settings | Description  | Reset | Access |
|------------|-----------------|-------|-----------------------------|----------|--|-------|--------|
|            |                 | 6     | SPI_DATAPATH_PRE            |          | SPI control of the data at the input of the datapath.<br>0 Disable or zero the data feeding into the datapath.<br>1 Use the data from the JESD204B lanes to drive into the datapath. | 0x1   | R/W    |
|            |                 | [5:4] | RESERVED                    |          | Reserved.  | 0x0   | R      |
|            |                 | 3     | TXEN_NCO_RESET              |          | Allows TX_ENABLE to control the DDS NCO reset.<br>0 Use the SPI (HOPF_MODE SPI bits) to control the DDS NCO reset.<br>1 Use the TX_ENABLE pin to control the DDS NCO reset.          | 0x0   | R/W    |
|            |                 | 2     | TXEN_DATAPATH_POST          |          | Allows TX_ENABLE to control the data at the output of the datapath.<br>0 Use the SPI (Bit SPI_DATAPATH_POST) for control.<br>1 Use the TX_ENABLE pin for control.                    | 0x0   | R/W    |
|            |                 | 1     | TXEN_DATAPATH_PRE           |          | Allows TX_ENABLE to control the data at the input of the datapath.<br>0 Use the SPI (Bit SPI_DATAPATH_PRE) for control.<br>1 Use the TX_ENABLE pin for control.                      | 0x0   | R/W    |
|            |                 | 0     | TXEN_DAC_FSC                |          | Allows TX_ENABLE to control the DAC full-scale current.<br>0 Use the SPI register ANA_FSC0 and ANA_FSC1 for control.<br>1 Use the TX_ENABLE pin for control.                         | 0x0   | R/W    |
| 0x040      | ANA_DAC_BIAS_PD | [7:2] | RESERVED                    |          | Reserved.  | 0x0   | R      |
|            |                 | 1     | ANA_DAC_BIAS_PD1            |          | Powers down the DAC core bias circuits. A 1 powers down the DAC core bias circuits.  | 0x1   | R/W    |
|            |                 | 0     | ANA_DAC_BIAS_PD0            |          | Powers down the DAC core bias circuits. A 1 powers down the DAC core bias circuits.  | 0x1   | R/W    |
| 0x041      | ANA_FSC0        | [7:2] | RESERVED                    |          | Reserved.  | 0x0   | R      |
|            |                 | [1:0] | ANA_FULL_SCALE_CURRENT[1:0] |          | DAC full-scale current. Analog full-scale current adjustment.  | 0x3   | R/W    |
| 0x042      | ANA_FSC1        | [7:0] | ANA_FULL_SCALE_CURRENT[9:2] |          | DAC full-scale current. Analog full-scale current adjustment.  | 0xFF  | R/W    |
| 0x07F      | CLK_PHASE_TUNE  | [7:6] | RESERVED                    |          | Reserved.  | 0x0   | R      |
|            |                 | [5:0] | CLK_PHASE_TUNE              |          | Fine tuning of the clock input phase balance. Adds small capacitors to the CLK+/CLK- inputs, ~ 20 fF per step, signed magnitude.   | 0x0   | R/W    |

| Hex. Addr. | Name           | Bits  | Bit Name           | Settings | Description   | Reset   | Access  |
|------------|----------------|-------|--------------------|----------|---|---------|---------|
|            |                |       |                    |          |   |         |         |
|            |                |       |                    |          | Bits[5:0]   | At CLK+ | At CLK- |
|            |                |       |                    |          | 000000  | 0       | 0       |
|            |                |       |                    |          | 000001  | 1       | 0       |
|            |                |       |                    |          | 000010  | 2       | 0       |
|            |                |       |                    |          | ...   | ...     | ...     |
|            |                |       |                    |          | 011111  | 31      | 0       |
|            |                |       |                    |          | 100000  | 0       | 0       |
|            |                |       |                    |          | 100001  | 0       | 1       |
|            |                |       |                    |          | 100010  | 0       | 2       |
|            |                |       |                    |          | 111111  | 0       | 31      |
| 0x080      | CLK_PD         | [7:1] | RESERVED           |          | Reserved.   | 0x0     | R       |
|            |                | 0     | DACCLK_PD          |          | DAC clock power-down. Powers down the DAC clock circuitry.<br>0 Power up.<br>1 Power down.  | 0x1     | R/W     |
| 0x082      | CLK_DUTY       | 7     | CLK_DUTY_EN        |          | Enable duty cycle control.  | 0x1     | R/W     |
|            |                | 6     | CLK_DUTY_OFFSET_EN |          | Enable duty cycle offset.   | 0x0     | R/W     |
|            |                | 5     | CLK_DUTY_BOOST_EN  |          | Enable duty cycle range boost. Extends range to $\pm 5\%$ at cost of 1 dB to 2 dB worse phase noise.  | 0x0     | R/W     |
|            |                | [4:0] | CLK_DUTY_PRG       |          | Program the duty cycle offset. 5-bit signed magnitude field, with the MSB as the sign bit and the four LSBs as the magnitude from 0 to 15. A larger magnitude skews duty cycle to a greater amount. Range is $\pm 3\%$ .                      | 0x0     | R/W     |
| 0x083      | CLK_CRS_CTRL   | 7     | CLK_CRS_EN         |          | Enable clock cross control adjustment.  | 0x1     | R/W     |
|            |                | [6:4] | RESERVED           |          | Reserved.   | 0x0     | R       |
|            |                | [3:0] | CLK_CRS_ADJ        |          | Program the clock crossing point.   | 0x0     | R/W     |
| 0x084      | PLL_REF_CLK_PD | [7:6] | RESERVED           |          | Reserved.   | 0x0     | R       |
|            |                | [5:4] | PLL_REF_CLK_RATE   |          | PLL reference clock rate multiplier.<br>00 Normal rate (1 $\times$ ) PLL reference clock.<br>01 Double rate (2 $\times$ ) PLL reference clock.<br>10 Quadruple rate (4 $\times$ ) PLL reference clock.<br>11 Disable the PLL reference clock. | 0x0     | R/W     |
|            |                | [3:1] | RESERVED           |          | Reserved.   | 0x0     | R       |
|            |                | 0     | PLL_REF_CLK_PD     |          | PLL reference clock power-down.<br>0 Enable the PLL reference clock.<br>1 Power down the PLL reference clock.   | 0x0     | R/W     |
| 0x088      | SYSREF_CTRL0   | [7:4] | RESERVED           |          | Reserved.   | 0x0     | R       |
|            |                | 3     | HYS_ON             |          | SYSREF $\pm$ hysteresis enable. This bit enables the programmable hysteresis control for the SYSREF $\pm$ receiver.   | 0x0     | R/W     |
|            |                | 2     | SYSREF_RISE        |          | Use SYSREF $\pm$ rising edge.   | 0x0     | R/W     |

| Hex. Addr. | Name         | Bits  | Bit Name         | Settings | Description  | Reset | Access |
|------------|--------------|-------|------------------|----------|--|-------|--------|
|            |              | [1:0] | HYS_CNTRL[9:8]   |          | Controls the amount of hysteresis in the SYSREF± receiver. Each of the 10 bits adds 10 mV of differential hysteresis to the receiver input.        | 0x0   | R/W    |
| 0x089      | SYSREF_CTRL1 | [7:0] | HYS_CNTRL[7:0]   |          | Controls the amount of hysteresis in the SYSREF± receiver. Each of the 10 bits adds 10 mV of differential hysteresis to the receiver input.        | 0x0   | R/W    |
| 0x090      | DLL_PD       | [7:5] | RESERVED         |          | Reserved.  | 0x0   | R      |
|            |              | 4     | DLL_FINE_DC_EN   |          | Fine delay line duty cycle correction enable.  | 0x1   | R/W    |
|            |              | 3     | DLL_FINE_XC_EN   |          | Fine delay line cross control enable.  | 0x1   | R/W    |
|            |              | 2     | DLL_COARSE_DC_EN |          | Coarse delay line duty cycle correction enable.  | 0x1   | R/W    |
|            |              | 1     | DLL_COARSE_XC_EN |          | Coarse delay line cross control enable.  | 0x1   | R/W    |
|            |              | 0     | DLL_CLK_PD       |          | Power down DLL and digital clock generator.<br>0 Power up DLL controller.<br>1 Power down DLL controller.  | 0x1   | R/W    |
| 0x091      | DLL_CTRL     | 7     | DLL_TRACK_ERR    |          | Track error behavior.<br>0 Continue on error.<br>1 Restart on error.   | 0x1   | R/W    |
|            |              | 6     | DLL_SEARCH_ERR   |          | Search error behavior.<br>0 Stop on error.<br>1 Retry on error.  | 0x1   | R/W    |
|            |              | 5     | DLL_SLOPE        |          | Desired slope.<br>0 Negative slope.<br>1 Positive slope.   | 0x1   | R/W    |
|            |              | [4:3] | DLL_SEARCH       |          | Search direction.<br>00 Search down from initial point only.<br>01 Search up from initial point only.<br>10 Search up and down from initial point. | 0x2   | R/W    |
|            |              | [2:1] | DLL_MODE         |          | Controller mode.<br>00 Search then track.<br>01 Track only.<br>10 Search only.   | 0x0   | R/W    |
|            |              | 0     | DLL_ENABLE       |          | Controller enable.<br>0 Disable DLL controller: use static SPI settings.<br>1 Enable DLL controller: use controller with feedback loop.            | 0x0   | R/W    |
| 0x092      | DLL_STATUS   | [7:3] | RESERVED         |          | Reserved.  | 0x0   | R      |
|            |              | 2     | DLL_FAIL         |          | The DAC clock DLL failed to lock.  | 0x0   | R      |
|            |              | 1     | DLL_LOST         |          | The DAC clock DLL has lost lock.   | 0x0   | R/W    |
|            |              | 0     | DLL_LOCKED       |          | The DAC clock DLL has achieved lock.   | 0x0   | R      |
| 0x093      | DLL_GB       | [7:4] | RESERVED         |          | Reserved.  | 0x0   | R      |
|            |              | [3:0] | DLL_GUARD        |          | Search guard band.   | 0x0   | R/W    |
| 0x094      | DLL_COARSE   | [7:6] | RESERVED         |          | Reserved.  | 0x0   | R      |
|            |              | [5:0] | DLL_COARSE       |          | Coarse delay line setpoint.  | 0x0   | R/W    |



| Hex. Addr. | Name           | Bits  | Bit Name      | Settings   | Description  | Reset | Access |
|------------|----------------|-------|---------------|--|--|-------|--------|
| 0x095      | DLL_FINE       | [7:0] | DLL_FINE      |  | Fine delay line setpoint.  | 0x80  | R/W    |
| 0x096      | DLL_PHASE      | [7:5] | RESERVED      |  | Reserved.  | 0x0   | R      |
|            |                | [4:0] | DLL_PHS       | 0<br>16  | Desired phase.<br>Minimum allowed phase.<br>Maximum allowed phase.   | 0x8   | R/W    |
| 0x097      | DLL_BW         | [7:5] | RESERVED      |  | Reserved.  | 0x0   | R      |
|            |                | [4:2] | DLL_FILT_BW   |  | Phase measurement filter bandwidth.  | 0x0   | R/W    |
|            |                | [1:0] | DLL_WEIGHT    |  | Tracking speed.  | 0x0   | R/W    |
| 0x098      | DLL_READ       | [7:1] | RESERVED      |  | Reserved.  | 0x0   | R      |
|            |                | 0     | DLL_READ      |  | Read request: 0 to 1 transition updates the coarse, fine, and phase readback values.   | 0x0   | R/W    |
| 0x099      | DLL_COARSE_RB  | [7:6] | RESERVED      |  | Reserved.  | 0x0   | R      |
|            |                | [5:0] | DLL_COARSE_RB |  | Coarse delay line readback.  | 0x0   | R      |
| 0x09A      | DLL_FINE_RB    | [7:0] | DLL_FINE_RB   |  | Fine delay line readback.  | 0x0   | R      |
| 0x09B      | DLL_PHASE_RB   | [7:5] | RESERVED      |  | Reserved.  | 0x0   | R      |
|            |                | [4:0] | DLL_PHS_RB    |  | Phase readback.  | 0x0   | R      |
| 0x09D      | DIG_CLK_INVERT | [7:3] | RESERVED      |  | Reserved.  | 0x0   | R      |
|            |                | 2     | INV_DIG_CLK   | 0<br>1   | Invert digital clock from DLL.<br>Normal polarity.<br>Inverted polarity.   | 0x0   | R/W    |
|            |                | 1     | DIG_CLK_DC_EN |  | Digital clock duty cycle correction enable.  | 0x1   | R/W    |
|            |                | 0     | DIG_CLK_XC_EN |  | Digital clock cross control enable.  | 0x1   | R/W    |
| 0x0A0      | DLL_CLK_DEBUG  | 7     | DLL_TEST_EN   |  | DLL clock output test enable.  | 0x0   | R/W    |
|            |                | [6:2] | RESERVED      |  | Reserved.  | 0x0   | R      |
|            |                | [1:0] | DLL_TEST_DIV  |  | DLL clock output divide.   | 0x0   | R/W    |
| 0x110      | INTERP_MODE    | [7:4] | JESD_LANES    |  | Number of JESD204B lanes. For proper operation of the JESD204B data link, this signal must only be programmed while the QBD is held in soft reset (Register 0x475, Bit 3), and must not be changed during normal operation.  | 0x8   | R/W    |
|            |                | [3:0] | INTERP_MODE   | 0000<br>0001<br>0010<br>0011<br>0100<br>0101<br>0110<br>0111<br>1000 | Interpolation mode. For proper operation of the JESD204B data link, this signal must only be programmed while the QBD is held in soft reset (Register 0x475, Bit 3), and must not be changed during normal operation.<br>1× (bypass) (this mode is not supported in the <a href="#">AD9161</a> ).<br>2×.<br>3×.<br>4×.<br>6×.<br>8×.<br>12×.<br>16×.<br>24×. | 0x1   | R/W    |
| 0x111      | DATAPATH_CFG   | 7     | INVSINC_EN    | 0<br>1   | Inverse sinc filter enable.<br>Disable inverse sinc filter.<br>Enable inverse sinc filter.   | 0x0   | R/W    |

| Hex. Addr. | Name | Bits  | Bit Name        | Settings | Description   | Reset | Access  |
|------------|------|-------|-----------------|----------|---|-------|---|
|            |      | 6     | NCO_EN          |          | Modulation enable.<br>0 Disable NCO.<br>1 Enable NCO.   | 0x0   | R/W   |
|            |      | 5     | RESERVED        |          | Reserved.   | 0x0   | R   |
|            |      | 4     | FILT_BW         |          | Datapath filter bandwidth.<br>0 Filter bandwidth is 80%.<br>1 Filter bandwidth is 90%.  | 0x0   | R/W   |
|            |      | 3     | RESERVED        |          | Reserved.   | 0x0   | R   |
|            |      | 2     | MODULUS_EN      |          | Modulus DDS enable<br>0 Disable modulus DDS.<br>1 Enable modulus DDS.   | 0x0   | R/W   |
|            |      | 1     | SEL_SIDE BAND   |          | Selects upper or lower sideband from modulation result.<br>0 Use upper sideband.<br>1 Use lower sideband = spectral flip.   | 0x0   | R/W   |
|            |      | 0     | FIR85_FILT_EN   |          | FIR85 filter enable.  | 0x0   | R/W   |
|            |      | 0x113 | FTW_UPDATE      | 7        | RESERVED  |       | Reserved.   |
|            |      | [6:4] | FTW_REQ_MODE    |          | Frequency tuning word automatic update mode.<br>000 No automatic requests are generated when the FTW registers are written.<br>001 Automatically generate FTW_LOAD_REQ after FTW0 is written.<br>010 Automatically generate FTW_LOAD_REQ after FTW1 is written.<br>011 Automatically generate FTW_LOAD_REQ after FTW2 is written.<br>100 Automatically generate FTW_LOAD_REQ after FTW3 is written.<br>101 Automatically generate FTW_LOAD_REQ after FTW4 is written.<br>110 Automatically generate FTW_LOAD_REQ after FTW5 is written. | 0x0   | R/W   |
|            |      | 3     | RESERVED        |          | Reserved.   | 0x0   | R   |
|            |      | 2     | FTW_LOAD_SYSREF |          | FTW load and reset from rising edge of SYSREF±.   | 0x0   | R/W   |
|            |      | 1     | FTW_LOAD_ACK    |          | Frequency tuning word update acknowledge.<br>0 FTW is not loaded.<br>1 FTW is loaded.   | 0x0   | R   |
|            |      | 0     | FTW_LOAD_REQ    |          | Frequency tuning word update request from SPI.<br>0 Clear FTW_LOAD_ACK.<br>1 0 to 1 transition loads the FTW.   | 0x0   | R/W   |
|            |      | 0x114 | FTW0            | [7:0]    | FTW[7:0]  |       | NCO frequency tuning word. This is X in the equation $f_{OUT} = f_{DAC} \times (M/N) = f_{DAC} \times ((X + A/B)/2^{48})$ . |

| Hex. Addr. | Name          | Bits  | Bit Name               | Settings | Description   | Reset | Access |
|------------|---------------|-------|------------------------|----------|---|-------|--------|
| 0x115      | FTW1          | [7:0] | FTW[15:8]              |          | NCO frequency tuning word. This is X in the equation $f_{OUT} = f_{DAC} \times (M/N) = f_{DAC} \times ((X + A/B)/2^{48})$ .   | 0x0   | R/W    |
| 0x116      | FTW2          | [7:0] | FTW[23:16]             |          | NCO frequency tuning word. This is X in the equation $f_{OUT} = f_{DAC} \times (M/N) = f_{DAC} \times ((X + A/B)/2^{48})$ .   | 0x0   | R/W    |
| 0x117      | FTW3          | [7:0] | FTW[31:24]             |          | NCO frequency tuning word. This is X in the equation $f_{OUT} = f_{DAC} \times (M/N) = f_{DAC} \times ((X + A/B)/2^{48})$ .   | 0x0   | R/W    |
| 0x118      | FTW4          | [7:0] | FTW[39:32]             |          | NCO frequency tuning word. This is X in the equation $f_{OUT} = f_{DAC} \times (M/N) = f_{DAC} \times ((X + A/B)/2^{48})$ .   | 0x0   | R/W    |
| 0x119      | FTW5          | [7:0] | FTW[47:40]             |          | NCO frequency tuning word. This is X in the equation $f_{OUT} = f_{DAC} \times (M/N) = f_{DAC} \times ((X + A/B)/2^{48})$ .   | 0x0   | R/W    |
| 0x11C      | PHASE_OFFSET0 | [7:0] | NCO_PHASE_OFFSET[7:0]  |          | NCO phase offset.   | 0x0   | R/W    |
| 0x11D      | PHASE_OFFSET1 | [7:0] | NCO_PHASE_OFFSET[15:8] |          | NCO phase offset.   | 0x0   | R/W    |
| 0x124      | ACC_MODULUS0  | [7:0] | ACC_MODULUS[7:0]       |          | DDS Modulus. This is B in the equation $f_{OUT} = f_{DAC} \times (M/N) = f_{DAC} \times ((X + A/B)/2^{48})$ . Note this modulus value is used for all NCO FTWs.   | 0x0   | R/W    |
| 0x125      | ACC_MODULUS1  | [7:0] | ACC_MODULUS[15:8]      |          | DDS Modulus. This is B in the equation $f_{OUT} = f_{DAC} \times (M/N) = f_{DAC} \times ((X + A/B)/2^{48})$ . Note this modulus value is used for all NCO FTWs.   | 0x0   | R/W    |
| 0x126      | ACC_MODULUS2  | [7:0] | ACC_MODULUS[23:16]     |          | DDS Modulus. This is B in the equation $f_{OUT} = f_{DAC} \times (M/N) = f_{DAC} \times ((X + A/B)/2^{48})$ . Note this modulus value is used for all NCO FTWs.   | 0x0   | R/W    |
| 0x127      | ACC_MODULUS3  | [7:0] | ACC_MODULUS[31:24]     |          | DDS Modulus. This is B in the equation $f_{OUT} = f_{DAC} \times (M/N) = f_{DAC} \times ((X + A/B)/2^{48})$ . Note this modulus value is used for all NCO FTWs.   | 0x0   | R/W    |
| 0x128      | ACC_MODULUS4  | [7:0] | ACC_MODULUS[39:32]     |          | DDS Modulus. This is B in the equation $f_{OUT} = f_{DAC} \times (M/N) = f_{DAC} \times ((X + A/B)/2^{48})$ . Note this modulus value is used for all NCO FTWs.   | 0x0   | R/W    |
| 0x129      | ACC_MODULUS5  | [7:0] | ACC_MODULUS[47:40]     |          | DDS Modulus. This is B in the equation $f_{OUT} = f_{DAC} \times (M/N) = f_{DAC} \times ((X + A/B)/2^{48})$ . Note this modulus value is used for all NCO FTWs.   | 0x0   | R/W    |
| 0x12A      | ACC_DELTA0    | [7:0] | ACC_DELTA[7:0]         |          | DDS Delta. This is A in the equation $f_{OUT} = f_{DAC} \times (M/N) = f_{DAC} \times ((X + A/B)/2^{48})$ . Note this modulus value is used for all NCO FTWs. Note this delta value is used for all NCO FTWs. | 0x0   | R/W    |
| 0x12B      | ACC_DELTA1    | [7:0] | ACC_DELTA[15:8]        |          | DDS Delta. This is A in the equation $f_{OUT} = f_{DAC} \times (M/N) = f_{DAC} \times ((X + A/B)/2^{48})$ . Note this modulus value is used for all NCO FTWs. Note this delta value is used for all NCO FTWs. | 0x0   | R/W    |

| Hex. Addr. | Name             | Bits  | Bit Name            | Settings        | Description   | Reset                 | Access |     |
|------------|------------------|-------|---------------------|-----------------|---|-----------------------|--------|-----|
| 0x12C      | ACC_DELTA2       | [7:0] | ACC_DELTA[23:16]    |                 | DDS Delta. This is A in the equation $f_{OUT} = f_{DAC} \times (M/N) = f_{DAC} \times ((X + A/B)/2^{48})$ . Note this modulus value is used for all NCO FTWs. Note this delta value is used for all NCO FTWs. | 0x0                   | R/W    |     |
| 0x12D      | ACC_DELTA3       | [7:0] | ACC_DELTA[31:24]    |                 | DDS Delta. This is 'A' in the equation $f_{OUT} = f_{DAC} \times (M/N) = f_{DAC} \times ((X + A/B)/2^{48})$ . Note this Delta value will be used for all NCO FTWs.  | 0x0                   | R/W    |     |
| 0x12E      | ACC_DELTA4       | [7:0] | ACC_DELTA[39:32]    |                 | DDS Delta. This is A in the equation $f_{OUT} = f_{DAC} \times (M/N) = f_{DAC} \times ((X + A/B)/2^{48})$ . Note this modulus value is used for all NCO FTWs. Note this delta value is used for all NCO FTWs. | 0x0                   | R/W    |     |
| 0x12F      | ACC_DELTA5       | [7:0] | ACC_DELTA[47:40]    |                 | DDS Delta. This is A in the equation $f_{OUT} = f_{DAC} \times (M/N) = f_{DAC} \times ((X + A/B)/2^{48})$ . Note this modulus value is used for all NCO FTWs. Note this delta value is used for all NCO FTWs. | 0x0                   | R/W    |     |
| 0x132      | TEMP_SENS_LSB    | [7:0] | TEMP_SENS_OUT[7:0]  |                 | Output of the temperature sensor ADC.   | 0x0                   | R      |     |
| 0x133      | TEMP_SENS_MSB    | [7:0] | TEMP_SENS_OUT[15:8] |                 | Output of the temperature sensor ADC.   | 0x0                   | R      |     |
| 0x134      | TEMP_SENS_UPDATE | [7:1] | RESERVED            |                 | Reserved.   | 0x0                   | R      |     |
|            |                  | 0     | TEMP_SENS_UPDATE    |                 | Set to 1 to update the temperature sensor reading with a new value.   | 0x0                   | R/W    |     |
| 0x135      | TEMP_SENS_CTRL   | 7     | TEMP_SENS_FAST      |                 | A 1 sets temperature sensor digital filter BW wider for faster settling time.   | 0x0                   | R/W    |     |
|            |                  | [6:1] | RESERVED            |                 | Reserved.   | 0x10                  | R/W    |     |
|            |                  | 0     | TEMP_SENS_ENABLE    |                 | Set to 1 to enable temperature sensor.  | 0x0                   | R/W    |     |
| 0x14B      | PRBS             | 7     | PRBS_GOOD_Q         |                 | Good data indicator imaginary channel.<br>0 Incorrect sequence detected.<br>1 Correct PRBS sequence detected.   | 0x0                   | R      |     |
|            |                  | 6     | PRBS_GOOD_I         |                 | Good data indicator real channel.<br>0 Incorrect sequence detected.<br>1 Correct PRBS sequence detected.  | 0x0                   | R      |     |
|            |                  | 5     | RESERVED            |                 | Reserved.   | 0x0                   | R      |     |
|            |                  | 4     | PRBS_INV_Q          |                 | Data inversion imaginary channel.<br>0 Expect normal data.<br>1 Expect inverted data.   | 0x1                   | R/W    |     |
|            |                  | 3     | PRBS_INV_I          |                 | Data inversion real channel.<br>0 Expect normal data.<br>1 Expect inverted data.  | 0x0                   | R/W    |     |
|            |                  | 2     | PRBS_MODE           |                 | Polynomial select.<br>0 7-bit: $x^7 + x^6 + 1$ .<br>1 15-bit: $x^{15} + x^{14} + 1$ .   | 0x0                   | R/W    |     |
|            |                  | 1     | PRBS_RESET          |                 |   | Reset error counters. | 0x0    | R/W |
|            |                  |       |                     | 0               |   | Normal operation.     |        |     |
|            |                  | 1     |                     | Reset counters. |   |                       |        |     |

| Hex. Addr. | Name          | Bits  | Bit Name           | Settings             | Description   | Reset | Access |
|------------|---------------|-------|--------------------|----------------------|---|-------|--------|
|            |               | 0     | PRBS_EN            | 0<br>1               | Enable PRBS checker.<br>Disable.<br>Enable.   | 0x0   | R/W    |
| 0x14C      | PRBS_ERROR_I  | [7:0] | PRBS_COUNT_I       |                      | Error count value real channel.   | 0x0   | R      |
| 0x14D      | PRBS_ERROR_Q  | [7:0] | PRBS_COUNT_Q       |                      | Error count value imaginary channel.  | 0x0   | R      |
| 0x14E      | TEST_DC_DATA1 | [7:0] | DC_TEST_DATA[15:8] |                      | DC test data. DC test mode is not supported on the <a href="#">AD9161</a> .   | 0x0   | R/W    |
| 0x14F      | TEST_DC_DATA0 | [7:0] | DC_TEST_DATA[7:0]  |                      | DC test data. DC test mode is not supported on the <a href="#">AD9161</a> .   | 0x0   | R/W    |
| 0x150      | DIG_TEST      | [7:2] | RESERVED           |                      | Reserved.   | 0x0   | R      |
|            |               | 1     | DC_TEST_EN         | 1<br>0               | DC data test mode enable. DC test mode is not supported on the <a href="#">AD9161</a> .<br>DC test mode enable.<br>DC test mode disable.          | 0x0   | R/W    |
|            |               | 0     | RESERVED           |                      | Reserved.   | 0x0   | R/W    |
| 0x151      | DECODE_CTRL   | [7:3] | RESERVED           |                      | Reserved.   | 0x0   | R/W    |
|            |               | 2     | SHUFFLE_MSB        | 0<br>1               | Shuffle mode. Enables shuffle mode for better spurious performance.<br>Disable MSB shuffling (use thermometer encoding).<br>Enable MSB shuffling. | 0x0   | R/W    |
|            |               | 1     | SHUFFLE_ISB        | 0<br>1               | Shuffle mode. Enables shuffle mode for better spurious performance.<br>Disable ISB shuffling (use thermometer encoding).<br>Enable ISB shuffling. | 0x0   | R/W    |
|            |               | 0     | SHUFFLE_DDR        | 0<br>1               | Shuffle mode. Enables shuffle mode for better spurious performance.<br>Disable DDR shuffling (use thermometer encoding).<br>Enable DDR shuffling. | 0x0   | R/W    |
| 0x152      | DECODE_MODE   | [7:2] | RESERVED           |                      | Reserved.   | 0x0   | R      |
|            |               | [1:0] | DECODE_MODE        | 00<br>01<br>10<br>11 | Decode mode.<br>Nonreturn-to-zero mode (first Nyquist).<br>Mix-Mode (second Nyquist).<br>Return to zero.<br>Reserved.                             | 0x0   | R/W    |
| 0x1DF      | SPI_STRENGTH  | [7:4] | RESERVED           |                      | Reserved.   | 0x0   | R      |
|            |               | [3:0] | SPIDRV             |                      | Slew and drive strength for CMOS SPI outputs. Slew = Bits[1:0], drive = Bits[3:2].  | 0xF   | R/W    |
| 0x200      | MASTER_PD     | [7:1] | RESERVED           |                      | Reserved.   | 0x0   | R      |
|            |               | 0     | SPI_PD_MASTER      |                      | Power down the entire JESD204B Rx analog (all eight channels and bias).   | 0x1   | R/W    |
| 0x201      | PHY_PD        | [7:0] | SPI_PD_PHY         |                      | SPI override to power down the individual PHYs.<br>Bit 0 controls the SERDIN0± PHY.<br>Bit 1 controls the SERDIN1± PHY.                           | 0x0   | R/W    |

| Hex. Addr. | Name                     | Bits  | Bit Name          | Settings | Description   | Reset | Access |
|------------|--------------------------|-------|-------------------|----------|---|-------|--------|
|            |                          |       |                   |          | Bit 2 controls the SERDIN2± PHY.<br>Bit 3 controls the SERDIN3± PHY.<br>Bit 4 controls the SERDIN4± PHY.<br>Bit 5 controls the SERDIN5± PHY.<br>Bit 6 controls the SERDIN6± PHY.<br>Bit 7 controls the SERDIN7± PHY.  |       |        |
| 0x203      | GENERIC_PD               | [7:2] | RESERVED          |          | Reserved.   | 0x0   | R      |
|            |                          | 1     | SPI_SYNC1_PD      |          | Power down LVDS buffer for the sync request signal, SYNCOUT.  | 0x0   | R/W    |
|            |                          | 0     | RESERVED          |          | Reserved.   | 0x0   | R/W    |
| 0x206      | CDR_RESET                | [7:1] | RESERVED          |          | Reserved.   | 0x0   | R      |
|            |                          | 0     | SPI_CDR_RESET     |          | Resets the digital control logic for all PHYs.<br>0 CDR logic is reset.<br>1 CDR logic is operational.  | 0x1   | R/W    |
| 0x230      | CDR_OPERATING_MODE_REG_0 | [7:6] | RESERVED          |          | Reserved.   | 0x0   | R/W    |
|            |                          | 5     | SPI_ENHALFRATE    |          | Enables half rate CDR operation, must be enabled for data rates above 6 Gbps.<br>0 Disables CDR half rate operation, data rate ≤ 6 Gbps.<br>1 Enables CDR half rate operation, data rate > 6 Gbps.  | 0x1   | R/W    |
|            |                          | [4:3] | RESERVED          |          | Reserved.   | 0x1   | R/W    |
|            |                          | [2:1] | SPI_DIVISION_RATE |          | Enables oversampling of the input data.<br>00 No division. Data rate > 3 Gbps.<br>01 Division by 2. 1.5 Gbps < data rate ≤ 3 Gbps.<br>10 Division by 4. 750 Mbps < data rate ≤ 1.5 Gbps.  | 0x0   | R/W    |
|            |                          | 0     | RESERVED          |          | Reserved.   | 0x0   | R/W    |
| 0x250      | EQ_CONFIG_PHY_0_1        | [7:4] | SPI_EQ_CONFIG1    |          | 0000 Manual mode (SPI configured values used).<br>0001 Boost level = 1.<br>0010 Boost level = 2.<br>0011 Boost level = 3.<br>0100 Boost level = 4.<br>0101 Boost level = 5.<br>0110 Boost level = 6.<br>0111 Boost level = 7.<br>1000 Boost level = 8.<br>1001 Boost level = 9.<br>1010 Boost level = 10.<br>1011 Boost level = 11.<br>1100 Boost level = 12.<br>1101 Boost level = 13.<br>1110 Boost level = 14.<br>1111 Boost level = 15. | 0x8   | R/W    |

| Hex. Addr. | Name              | Bits  | Bit Name       | Settings   | Description   | Reset | Access |
|------------|-------------------|-------|----------------|--|---|-------|--------|
|            |                   | [3:0] | SPI_EQ_CONFIG0 | 0000<br>0001<br>0010<br>0011<br>0100<br>0101<br>0110<br>0111<br>1000<br>1001<br>1010<br>1011<br>1100<br>1101<br>1110<br>1111 | Manual mode (SPI configured values used).<br>Boost level = 1.<br>Boost level = 2.<br>Boost level = 3.<br>Boost level = 4.<br>Boost level = 5.<br>Boost level = 6.<br>Boost level = 7.<br>Boost level = 8.<br>Boost level = 9.<br>Boost level = 10.<br>Boost level = 11.<br>Boost level = 12.<br>Boost level = 13.<br>Boost level = 14.<br>Boost level = 15. | 0x8   | R/W    |
| 0x251      | EQ_CONFIG_PHY_2_3 | [7:4] | SPI_EQ_CONFIG3 | 0000<br>0001<br>0010<br>0011<br>0100<br>0101<br>0110<br>0111<br>1000<br>1001<br>1010<br>1011<br>1100<br>1101<br>1110<br>1111 | Manual mode (SPI configured values used).<br>Boost level = 1.<br>Boost level = 2.<br>Boost level = 3.<br>Boost level = 4.<br>Boost level = 5.<br>Boost level = 6.<br>Boost level = 7.<br>Boost level = 8.<br>Boost level = 9.<br>Boost level = 10.<br>Boost level = 11.<br>Boost level = 12.<br>Boost level = 13.<br>Boost level = 14.<br>Boost level = 15. | 0x8   | R/W    |
|            |                   | [3:0] | SPI_EQ_CONFIG2 | 0000<br>0001<br>0010<br>0011<br>0100<br>0101<br>0110<br>0111<br>1000<br>1001<br>1010<br>1011<br>1100<br>1101<br>1110<br>1111 | Manual mode (SPI configured values used).<br>Boost level = 1.<br>Boost level = 2.<br>Boost level = 3.<br>Boost level = 4.<br>Boost level = 5.<br>Boost level = 6.<br>Boost level = 7.<br>Boost level = 8.<br>Boost level = 9.<br>Boost level = 10.<br>Boost level = 11.<br>Boost level = 12.<br>Boost level = 13.<br>Boost level = 14.<br>Boost level = 15. | 0x8   | R/W    |

| Hex. Addr. | Name              | Bits  | Bit Name       | Settings  | Description   | Reset | Access |
|------------|-------------------|-------|----------------|---|---|-------|--------|
| 0x252      | EQ_CONFIG_PHY_4_5 | [7:4] | SPI_EQ_CONFIG5 | 0000 Manual mode (SPI configured values used).<br>0001 Boost level = 1.<br>0010 Boost level = 2.<br>0011 Boost level = 3.<br>0100 Boost level = 4.<br>0101 Boost level = 5.<br>0110 Boost level = 6.<br>0111 Boost level = 7.<br>1000 Boost level = 8.<br>1001 Boost level = 9.<br>1010 Boost level = 10.<br>1011 Boost level = 11.<br>1100 Boost level = 12.<br>1101 Boost level = 13.<br>1110 Boost level = 14.<br>1111 Boost level = 15. | Manual mode (SPI configured values used).<br>Boost level = 1.<br>Boost level = 2.<br>Boost level = 3.<br>Boost level = 4.<br>Boost level = 5.<br>Boost level = 6.<br>Boost level = 7.<br>Boost level = 8.<br>Boost level = 9.<br>Boost level = 10.<br>Boost level = 11.<br>Boost level = 12.<br>Boost level = 13.<br>Boost level = 14.<br>Boost level = 15. | 0x8   | R/W    |
|            |                   | [3:0] | SPI_EQ_CONFIG4 | 0000 Manual mode (SPI configured values used).<br>0001 Boost level = 1.<br>0010 Boost level = 2.<br>0011 Boost level = 3.<br>0100 Boost level = 4.<br>0101 Boost level = 5.<br>0110 Boost level = 6.<br>0111 Boost level = 7.<br>1000 Boost level = 8.<br>1001 Boost level = 9.<br>1010 Boost level = 10.<br>1011 Boost level = 11.<br>1100 Boost level = 12.<br>1101 Boost level = 13.<br>1110 Boost level = 14.<br>1111 Boost level = 15. |   | 0x8   | R/W    |
| 0x253      | EQ_CONFIG_PHY_6_7 | [7:4] | SPI_EQ_CONFIG7 | 0000 Manual mode (SPI configured values used).<br>0001 Boost level = 1.<br>0010 Boost level = 2.<br>0011 Boost level = 3.<br>0100 Boost level = 4.<br>0101 Boost level = 5.<br>0110 Boost level = 6.<br>0111 Boost level = 7.<br>1000 Boost level = 8.<br>1001 Boost level = 9.<br>1010 Boost level = 10.<br>1011 Boost level = 11.<br>1100 Boost level = 12.<br>1101 Boost level = 13.<br>1110 Boost level = 14.<br>1111 Boost level = 15. | Manual mode (SPI configured values used).<br>Boost level = 1.<br>Boost level = 2.<br>Boost level = 3.<br>Boost level = 4.<br>Boost level = 5.<br>Boost level = 6.<br>Boost level = 7.<br>Boost level = 8.<br>Boost level = 9.<br>Boost level = 10.<br>Boost level = 11.<br>Boost level = 12.<br>Boost level = 13.<br>Boost level = 14.<br>Boost level = 15. | 0x8   | R/W    |



| Hex. Addr. | Name               | Bits  | Bit Name                  | Settings  | Description  | Reset | Access |
|------------|--------------------|-------|---------------------------|---|--|-------|--------|
|            |                    | [3:0] | SPI_EQ_CONFIG6            | 0000 Manual mode (SPI configured values used).<br>0001 Boost level = 1.<br>0010 Boost level = 2.<br>0011 Boost level = 3.<br>0100 Boost level = 4.<br>0101 Boost level = 5.<br>0110 Boost level = 6.<br>0111 Boost level = 7.<br>1000 Boost level = 8.<br>1001 Boost level = 9.<br>1010 Boost level = 10.<br>1011 Boost level = 11.<br>1100 Boost level = 12.<br>1101 Boost level = 13.<br>1110 Boost level = 14.<br>1111 Boost level = 15. |  | 0x8   | R/W    |
| 0x268      | EQ_BIAS_REG        | [7:6] | EQ_POWER_MODE             | 00 Normal mode.<br>01 Low power mode.   | Controls the equalizer power mode/insertion loss capability.   | 0x1   | R/W    |
|            |                    | [5:0] | RESERVED                  |   | Reserved.  | 0x4   | R/W    |
| 0x280      | SYNTH_ENABLE_CNTRL | [7:3] | RESERVED                  |   | Reserved.  | 0x0   | R      |
|            |                    | 2     | SPI_RECAL_SYNTH           |   | Set this bit high to rerun all of the SERDES PLL calibration routines. Set this bit low again to allow additional recalibrations. Rising edge causes the calibration.                | 0x0   | R/W    |
|            |                    | 1     | RESERVED                  |   | Reserved.  | 0x0   | R/W    |
|            |                    | 0     | SPI_ENABLE_SYNTH          |   | Enable the SERDES PLL. Setting this bit turns on all currents and proceeds to calibrate the PLL. Make sure reference clock and division ratios are correct before enabling this bit. | 0x0   | R/W    |
| 0x281      | PLL_STATUS         | [7:6] | RESERVED                  |   | Reserved.  | 0x0   | R      |
|            |                    | 5     | SPI_CP_OVER_RANGE_HIGH_RB | 0 Charge pump output is within operating range.<br>1 Charge pump output is above operating range.   | If set, the SERDES PLL CP output is above valid operating range.   | 0x0   | R      |
|            |                    | 4     | SPI_CP_OVER_RANGE_LOW_RB  | 0 Charge pump output is within operating range.<br>1 Charge pump output is below operating range.   | If set, the SERDES PLL CP output is below valid operating range.   | 0x0   | R      |
|            |                    | 3     | SPI_CP_CAL_VALID_RB       | 0 Charge pump calibration is not valid.<br>1 Charge pump calibration is valid.  | This bit tells the user if the charge pump calibration has completed and is valid.   | 0x0   | R      |
|            |                    | [2:1] | RESERVED                  |   | Reserved.  | 0x0   | R      |

| Hex. Addr. | Name                | Bits  | Bit Name                        | Settings | Description   | Reset | Access |
|------------|---------------------|-------|---------------------------------|----------|---|-------|--------|
|            |                     | 0     | SPI_PLL_LOCK_RB                 |          | If set, the SERDES synthesizer locked.<br>0 PLL is not locked.<br>1 PLL is locked.  | 0x0   | R      |
| 0x289      | REF_CLK_DIVIDER_LDO | [7:2] | RESERVED                        |          | Reserved.   | 0x0   | R      |
|            |                     | [1:0] | SERDES_PLL_DIV_FACTOR           |          | SERDES PLL reference clock division factor. This field controls the division of the SERDES PLL reference clock before it is fed into the SERDES PLL PFD. It must be set so that $f_{REF}/DivFactor$ is between 35 MHz and 80 MHz.<br>00 Divide by 4 for lane rate between 6 Gbps and 12.5 Gbps.<br>01 Divide by 2 for lane rate between 3 Gbps and 6 Gbps.<br>10 Divide by 1 for lane rate between 1.5 Gbps and 3 Gbps.   | 0x0   | R/W    |
| 0x2A7      | TERM_BLK1_CTRLREG0  | [7:1] | RESERVED                        |          | Reserved.   | 0x0   | R      |
|            |                     | 0     | SPI_I_TUNE_R_CAL_TERMBLK1       |          | Rising edge of this bit starts a termination calibration routine.   | 0x0   | R/W    |
| 0x2A8      | TERM_BLK1_CTRLREG1  | [7:0] | SPI_I_SERIALIZER_RTRIM_TERMBLK1 |          | SPI override for termination value for PHY 0, PHY 1, PHY 6, and PHY 7. Value options are as follows:<br>XXX0XXXX Automatically calibrate termination value.<br>XXX1000X Force 000 as termination value.<br>XXX1001X Force 001 as termination value.<br>XXX1010X Force 010 as termination value.<br>XXX1011X Force 011 as termination value.<br>XXX1100X Force 100 as termination value.<br>XXX1101X Force 101 as termination value.<br>XXX1110X Force 110 as termination value.<br>XXX1111X Force 111 as termination value.<br>XXX1000X Force 000 as termination value. | 0x0   | R/W    |
| 0x2AC      | TERM_BLK1_RD_REG0   | [7:4] | RESERVED                        |          | Reserved.   | 0x0   | R      |
|            |                     | [3:0] | SPI_O_RCAL_CODE_TERMBLK1        |          | Readback of calibration code for PHY 0, PHY 1, PHY 6, and PHY 7.  | 0x0   | R      |
| 0x2AE      | TERM_BLK2_CTRLREG0  | [7:1] | RESERVED                        |          | Reserved.   | 0x0   | R      |
|            |                     | 0     | SPI_I_TUNE_R_CAL_TERMBLK2       |          | Rising edge of this bit starts a termination calibration routine.   | 0x0   | R/W    |
| 0x2AF      | TERM_BLK2_CTRLREG1  | [7:0] | SPI_I_SERIALIZER_RTRIM_TERMBLK2 |          | SPI override for termination value for PHY 2, PHY 3, PHY 4, and PHY 5. Value options are as follows:<br>XXX0XXXX Automatically calibrate termination value.<br>XXX1000X Force 000 as termination value.<br>XXX1001X Force 001 as termination value.<br>XXX1010X Force 010 as termination value.<br>XXX1011X Force 011 as termination value.<br>XXX1100X Force 100 as termination value.<br>XXX1101X Force 101 as termination value.<br>XXX1110X Force 110 as termination value.<br>XXX1111X Force 111 as termination value.   | 0x0   | R/W    |

| Hex. Addr. | Name              | Bits  | Bit Name                 | Settings | Description  | Reset | Access |
|------------|-------------------|-------|--------------------------|----------|--|-------|--------|
|            |                   |       |                          | XXX1000X | Force 000 as termination value.  |       |        |
| 0x2B3      | TERM_BLK2_RD_REG0 | [7:4] | RESERVED                 |          | Reserved.  | 0x0   | R      |
|            |                   | [3:0] | SPI_O_RCAL_CODE_TERMCLK2 |          | Readback of calibration code for PHY 2, PHY 3, PHY 4, and PHY 5.   | 0x0   | R      |
| 0x2BB      | TERM_OFFSET_0     | [7:4] | RESERVED                 |          | Reserved.  | 0x0   | R      |
|            |                   | [3:0] | TERM_OFFSET_0            |          | Add or subtract from the termination calibration value of Physical Lane 0. 4-bit signed magnitude value that adds to or subtracts from the termination value. Bit 3 is the sign bit, and Bits[2:0] are the magnitude bits. | 0x0   | R/W    |
| 0x2BC      | TERM_OFFSET_1     | [7:4] | RESERVED                 |          | Reserved.  | 0x0   | R      |
|            |                   | [3:0] | TERM_OFFSET_1            |          | Add or subtract from the termination calibration value of Physical Lane 1. 4-bit signed magnitude value that adds to or subtracts from the termination value. Bit 3 is the sign bit, and Bits[2:0] are the magnitude bits. | 0x0   | R/W    |
| 0x2BD      | TERM_OFFSET_2     | [7:4] | RESERVED                 |          | Reserved.  | 0x0   | R      |
|            |                   | [3:0] | TERM_OFFSET_2            |          | Add or subtract from the termination calibration value of Physical Lane 2. 4-bit signed magnitude value that adds to or subtracts from the termination value. Bit 3 is the sign bit, and Bits[2:0] are the magnitude bits. | 0x0   | R/W    |
| 0x2BE      | TERM_OFFSET_3     | [7:4] | RESERVED                 |          | Reserved.  | 0x0   | R      |
|            |                   | [3:0] | TERM_OFFSET_3            |          | Add or subtract from the termination calibration value of Physical Lane 3. 4-bit signed magnitude value that adds to or subtracts from the termination value. Bit 3 is the sign bit, and Bits[2:0] are the magnitude bits. | 0x0   | R/W    |
| 0x2BF      | TERM_OFFSET_4     | [7:4] | RESERVED                 |          | Reserved.  | 0x0   | R      |
|            |                   | [3:0] | TERM_OFFSET_4            |          | Add or subtract from the termination calibration value of Physical Lane 4. 4-bit signed magnitude value that adds to or subtracts from the termination value. Bit 3 is the sign bit, and Bits[2:0] are the magnitude bits. | 0x0   | R/W    |
| 0x2C0      | TERM_OFFSET_5     | [7:4] | RESERVED                 |          | Reserved.  | 0x0   | R      |
|            |                   | [3:0] | TERM_OFFSET_5            |          | Add or subtract from the termination calibration value of Physical Lane 5. 4-bit signed magnitude value that adds to or subtracts from the termination value. Bit 3 is the sign bit, and Bits[2:0] are the magnitude bits. | 0x0   | R/W    |

| Hex. Addr. | Name               | Bits  | Bit Name           | Settings   | Description   | Reset | Access |
|------------|--------------------|-------|--------------------|--|---|-------|--------|
| 0x2C1      | TERM_OFFSET_6      | [7:4] | RESERVED           |  | Reserved.   | 0x0   | R      |
|            |                    | [3:0] | TERM_OFFSET_6      |  | Add or subtract from the termination calibration value of Physical Lane 6. 4-bit signed magnitude value that adds to or subtracts from the termination value. Bit 3 is the sign bit, and Bits[2:0] are the magnitude bits.  | 0x0   | R/W    |
| 0x2C2      | TERM_OFFSET_7      | [7:4] | RESERVED           |  | Reserved.   | 0x0   | R      |
|            |                    | [3:0] | TERM_OFFSET_7      |  | Add or subtract from the termination calibration value of Physical Lane 7. 4-bit signed magnitude value that adds to or subtracts from the termination value. Bit 3 is the sign bit, and Bits[2:0] are the magnitude bits.  | 0x0   | R/W    |
| 0x300      | GENERAL_JRX_CTRL_0 | 7     | RESERVED           |  | Reserved.   | 0x0   | R      |
|            |                    | 6     | CHECKSUM_MODE      | 0<br>1   | JESD204B link parameter checksum calculation method.<br>0 Checksum is sum of fields.<br>1 Checksum is sum of octets.  | 0x0   | R/W    |
|            |                    | [5:1] | RESERVED           |  | Reserved.   | 0x0   | R      |
|            |                    | 0     | LINK_EN            |  | This bit brings up the JESD204B receiver when all link parameters are programmed and all clocks are ready.  | 0x0   | R/W    |
| 0x302      | DYN_LINK_LATENCY_0 | [7:5] | RESERVED           |  | Reserved.   | 0x0   | R      |
|            |                    | [4:0] | DYN_LINK_LATENCY_0 |  | Measurement of the JESD204B link delay (in PCLK units). Link 0 dynamic link latency. Latency between current deframer LMFC and the global LMFC.   | 0x0   | R      |
| 0x304      | LMFC_DELAY_0       | [7:5] | RESERVED           |  | Reserved.   | 0x0   | R      |
|            |                    | [4:0] | LMFC_DELAY_0       |  | Fixed part of the JESD204B link delay (in PCLK units). Delay in frame clock cycles for global LMFC for Link 0.  | 0x0   | R/W    |
| 0x306      | LMFC_VAR_0         | [7:5] | RESERVED           |  | Reserved.   | 0x0   | R      |
|            |                    | [4:0] | LMFC_VAR_0         |  | Variable part of the JESD204B link delay (in PCLK units). Location in Rx LMFC where JESD204B words are read out from buffer. This setting must not be more than 10 PCLKs.   | 0x1F  | R/W    |
| 0x308      | XBAR_LN_0_1        | [7:6] | RESERVED           |  | Reserved.   | 0x0   | R      |
|            |                    | [5:3] | SRC_LANE1          | 000<br>001<br>010<br>011<br>100<br>101<br>110<br>111 | Select data from SERDIN0±, SERDIN1±, ..., or SERDIN7± for Logic Lane 1.<br>000 Data is from SERDIN0±.<br>001 Data is from SERDIN1±.<br>010 Data is from SERDIN2±.<br>011 Data is from SERDIN3±.<br>100 Data is from SERDIN4±.<br>101 Data is from SERDIN5±.<br>110 Data is from SERDIN6±.<br>111 Data is from SERDIN7±. | 0x1   | R/W    |

| Hex. Addr. | Name        | Bits  | Bit Name  | Settings | Description   | Reset | Access |
|------------|-------------|-------|-----------|----------|---|-------|--------|
|            |             | [2:0] | SRC_LANE0 |          | Select data from SERDIN0±, SERDIN1±, ..., or SERDIN7± for Logic Lane 0.<br><br>000 Data is from SERDIN0±.<br>001 Data is from SERDIN1±.<br>010 Data is from SERDIN2±.<br>011 Data is from SERDIN3±.<br>100 Data is from SERDIN4±.<br>101 Data is from SERDIN5±.<br>110 Data is from SERDIN6±.<br>111 Data is from SERDIN7±. | 0x0   | R/W    |
| 0x309      | XBAR_LN_2_3 | [7:6] | RESERVED  |          | Reserved.   | 0x0   | R      |
|            |             | [5:3] | SRC_LANE3 |          | Select data from SERDIN0±, SERDIN1±, ..., or SERDIN7± for Logic Lane 3.<br><br>000 Data is from SERDIN0±.<br>001 Data is from SERDIN1±.<br>010 Data is from SERDIN2±.<br>011 Data is from SERDIN3±.<br>100 Data is from SERDIN4±.<br>101 Data is from SERDIN5±.<br>110 Data is from SERDIN6±.<br>111 Data is from SERDIN7±. | 0x3   | R/W    |
|            |             | [2:0] | SRC_LANE2 |          | Select data from SERDIN0±, SERDIN1±, ..., or SERDIN7± for Logic Lane 2.<br><br>000 Data is from SERDIN0±.<br>001 Data is from SERDIN1±.<br>010 Data is from SERDIN2±.<br>011 Data is from SERDIN3±.<br>100 Data is from SERDIN4±.<br>101 Data is from SERDIN5±.<br>110 Data is from SERDIN6±.<br>111 Data is from SERDIN7±. | 0x2   | R/W    |
| 0x30A      | XBAR_LN_4_5 | [7:6] | RESERVED  |          | Reserved.   | 0x0   | R      |
|            |             | [5:3] | SRC_LANES |          | Select data from SERDIN0±, SERDIN1±, ..., or SERDIN7± for Logic Lane 5.<br><br>000 Data is from SERDIN0±.<br>001 Data is from SERDIN1±.<br>010 Data is from SERDIN2±.<br>011 Data is from SERDIN3±.<br>100 Data is from SERDIN4±.<br>101 Data is from SERDIN5±.<br>110 Data is from SERDIN6±.<br>111 Data is from SERDIN7±. | 0x5   | R/W    |
|            |             | [2:0] | SRC_LANE4 |          | Select data from SERDIN0±, SERDIN1±, ..., or SERDIN7± for Logic Lane 4.<br><br>000 Data is from SERDIN0±.<br>001 Data is from SERDIN1±.<br>010 Data is from SERDIN2±.<br>011 Data is from SERDIN3±.<br>100 Data is from SERDIN4±.<br>101 Data is from SERDIN5±.   | 0x4   | R/W    |

| Hex. Addr. | Name              | Bits  | Bit Name        | Settings | Description  | Reset | Access |
|------------|-------------------|-------|-----------------|----------|--|-------|--------|
|            |                   |       |                 | 110      | Data is from SERDIN6±.   |       |        |
|            |                   |       |                 | 111      | Data is from SERDIN7±.   |       |        |
| 0x30B      | XBAR_LN_6_7       | [7:6] | RESERVED        |          | Reserved.  | 0x0   | R      |
|            |                   | [5:3] | SRC_LANE7       |          | Select data from SERDIN0±, SERDIN1±, ..., or SERDIN7± for Logic Lane 7.  | 0x7   | R/W    |
|            |                   |       |                 | 000      | Data is from SERDIN0±.   |       |        |
|            |                   |       |                 | 001      | Data is from SERDIN1±.   |       |        |
|            |                   |       |                 | 010      | Data is from SERDIN2±.   |       |        |
|            |                   |       |                 | 011      | Data is from SERDIN3±.   |       |        |
|            |                   |       |                 | 100      | Data is from SERDIN4±.   |       |        |
|            |                   |       |                 | 101      | Data is from SERDIN5±.   |       |        |
|            |                   |       |                 | 110      | Data is from SERDIN6±.   |       |        |
|            |                   |       |                 | 111      | Data is from SERDIN7±.   |       |        |
|            |                   | [2:0] | SRC_LANE6       |          | Select data from SERDIN0±, SERDIN1±, ..., or SERDIN7± for Logic Lane 6.  | 0x6   | R/W    |
|            |                   |       |                 | 000      | Data is from SERDIN0±.   |       |        |
|            |                   |       |                 | 001      | Data is from SERDIN1±.   |       |        |
|            |                   |       |                 | 010      | Data is from SERDIN2±.   |       |        |
|            |                   |       |                 | 011      | Data is from SERDIN3±.   |       |        |
|            |                   |       |                 | 100      | Data is from SERDIN4±.   |       |        |
|            |                   |       |                 | 101      | Data is from SERDIN5±.   |       |        |
|            |                   |       |                 | 110      | Data is from SERDIN6±.   |       |        |
|            |                   |       |                 | 111      | Data is from SERDIN7±.   |       |        |
| 0x30C      | FIFO_STATUS_REG_0 | [7:0] | LANE_FIFO_FULL  |          | Bit 0 corresponds to FIFO full flag for data from SERDIN0±.<br>Bit 1 corresponds to FIFO full flag for data from SERDIN1±.<br>Bit 2 corresponds to FIFO full flag for data from SERDIN2±.<br>Bit 3 corresponds to FIFO full flag for data from SERDIN3±.<br>Bit 4 corresponds to FIFO full flag for data from SERDIN4±.  | 0x0   | R      |
|            |                   |       |                 |          | Bit 5 corresponds to FIFO full flag for data from SERDIN5±.<br>Bit 6 corresponds to FIFO full flag for data from SERDIN6±.<br>Bit 7 corresponds to FIFO full flag for data from SERDIN7±.  |       |        |
| 0x30D      | FIFO_STATUS_REG_1 | [7:0] | LANE_FIFO_EMPTY |          | Bit 0 corresponds to FIFO empty flag for data from SERDIN0±.<br>Bit 1 corresponds to FIFO empty flag for data from SERDIN1±.<br>Bit 2 corresponds to FIFO empty flag for data from SERDIN2±.<br>Bit 3 corresponds to FIFO empty flag for data from SERDIN3±.<br>Bit 4 corresponds to FIFO empty flag for data from SERDIN4±.<br>Bit 5 corresponds to FIFO empty flag for data from SERDIN5±.<br>Bit 6 corresponds to FIFO empty flag for data from SERDIN6±.<br>Bit 7 corresponds to FIFO empty flag for data from SERDIN7±. | 0x0   | R      |

| Hex. Addr. | Name               | Bits  | Bit Name         | Settings | Description  | Reset | Access |
|------------|--------------------|-------|------------------|----------|--|-------|--------|
| 0x311      | SYNC_GEN_0         | [7:3] | RESERVED         |          | Reserved.  | 0x0   | R      |
|            |                    | 2     | EOMF_MASK_0      |          | Mask EOMF from QBD_0. Assert SYNCOUT based on loss of multiframe sync.<br>0 Don not assert SYNCOUT on loss of multiframe.<br>1 Assert SYNCOUT on loss of multiframe.   | 0x0   | R/W    |
|            |                    | 1     | RESERVED         |          | Reserved.  | 0x0   | R/W    |
|            |                    | 0     | EOF_MASK_0       |          | Mask EOF from QBD_0. Assert SYNCOUT based on loss of frame sync.<br>0 Do not assert SYNCOUT on loss of frame.<br>1 Assert SYNCOUT on loss of frame.  | 0x0   | R/W    |
| 0x312      | SYNC_GEN_1         | [7:4] | SYNC_ERR_DUR     |          | Duration of SYNCOUT signal low for purpose of sync error report. 0 means half PCLK cycle. Add an additional PCLK = 4 octets for each increment of the value.   | 0x0   | R/W    |
|            |                    | [3:0] | SYNC_SYNCREQ_DUR |          | Duration of SYNCOUT signal low for purpose of sync request. 0 means 5 frame + 9 octets. Add an additional PCLK = 4 octets for each increment of the value.   | 0x0   | R/W    |
| 0x313      | SYNC_GEN_3         | [7:0] | LMFC_PERIOD      |          | LMFC period in PCLK cycle. This is to report the global LMFC period based on PCLK.   | 0x0   | R      |
| 0x315      | PHY_PRBS_TEST_EN   | [7:0] | PHY_TEST_EN      |          | Enable PHY BER by ungating the clocks.<br>1 PHY test enable.<br>0 PHY test disable.  | 0x0   | R/W    |
| 0x316      | PHY_PRBS_TEST_CTRL | 7     | RESERVED         |          | Reserved.  | 0x0   | R      |
|            |                    | [6:4] | PHY_SRC_ERR_CNT  |          | 000 Report Lane 0 error count.<br>001 Report Lane 1 error count.<br>010 Report Lane 2 error count.<br>011 Report Lane 3 error count.<br>100 Report Lane 4 error count.<br>101 Report Lane 5 error count.<br>110 Report Lane 6 error count.<br>111 Report Lane 7 error count. | 0x0   | R/W    |
|            |                    | [3:2] | PHY_PRBS_PAT_SEL |          | Select PRBS pattern for PHY BER test.<br>00 PRBS7.<br>01 PRBS15.<br>10 PRBS31.<br>11 Not used.   | 0x0   | R/W    |
|            |                    | 1     | PHY_TEST_START   |          | Start and stop the PHY PRBS test.<br>0 Test not started.<br>1 Test started.  | 0x0   | R/W    |
|            |                    | 0     | PHY_TEST_RESET   |          | Reset PHY PRBS test state machine and error counters.<br>0 Not reset.<br>1 Reset.  | 0x0   | R/W    |

| Hex. Addr. | Name                            | Bits  | Bit Name                   | Settings | Description   | Reset | Access |
|------------|---------------------------------|-------|----------------------------|----------|---|-------|--------|
| 0x317      | PHY_PRBS_TEST_THRESHOLD_LOBITS  | [7:0] | PHY_PRBS_THRESHOLD_LOBITS  |          | Bits[7:0] of the 24-bit threshold value set the error flag for PHY PRBS test.             | 0x0   | R/W    |
| 0x318      | PHY_PRBS_TEST_THRESHOLD_MIDBITS | [7:0] | PHY_PRBS_THRESHOLD_MIDBITS |          | Bits[15:8] of the 24-bit threshold value set the error flag for PHY PRBS test.            | 0x0   | R/W    |
| 0x319      | PHY_PRBS_TEST_THRESHOLD_HIBITS  | [7:0] | PHY_PRBS_THRESHOLD_HIBITS  |          | Bits[23:16] of the 24-bit threshold value set the error flag for PHY PRBS test.           | 0x0   | R/W    |
| 0x31A      | PHY_PRBS_TEST_ERRCNT_LOBITS     | [7:0] | PHY_PRBS_ERR_CNT_LOBITS    |          | Bits[7:0] of the 24-bit reported PHY BER test error count from selected lane.             | 0x0   | R      |
| 0x31B      | PHY_PRBS_TEST_ERRCNT_MIDBITS    | [7:0] | PHY_PRBS_ERR_CNT_MIDBITS   |          | Bits[15:8] of the 24-bit reported PHY BER test error count from selected lane.            | 0x0   | R      |
| 0x31C      | PHY_PRBS_TEST_ERRCNT_HIBITS     | [7:0] | PHY_PRBS_ERR_CNT_HIBITS    |          | Bits[23:16] of the 24-bit reported PHY BER test error count from selected lane.           | 0x0   | R      |
| 0x31D      | PHY_PRBS_TEST_STATUS            | [7:0] | PHY_PRBS_PASS              |          | Each bit is for the corresponding lane. Report PHY BER test pass/fail for each lane.      | 0xFF  | R      |
| 0x31E      | PHY_DATA_SNAPSHOT_CTRL          | [7:5] | RESERVED                   |          | Reserved.   | 0x0   | R      |
|            |                                 | [4:2] | PHY_GRAB_LANE_SEL          |          | Select which lane to grab data.   | 0x0   | R/W    |
|            |                                 |       |                            | 000      | Grab data from Lane 0.  |       |        |
|            |                                 |       |                            | 001      | Grab data from Lane 1.  |       |        |
|            |                                 |       |                            | 010      | Grab data from Lane 2.  |       |        |
|            |                                 |       |                            | 011      | Grab data from Lane 3.  |       |        |
|            |                                 |       |                            | 100      | Grab data from Lane 4.  |       |        |
|            |                                 |       |                            | 101      | Grab data from Lane 5.  |       |        |
|            |                                 |       |                            | 110      | Grab data from Lane 6.  |       |        |
|            |                                 |       |                            | 111      | Grab data from Lane 7.  |       |        |
|            |                                 | 1     | PHY_GRAB_MODE              |          | Use error trigger to grab data.   | 0x0   | R/W    |
|            |                                 |       |                            | 0        | Grab data when PHY_GRAB_DATA is set.  |       |        |
|            |                                 |       |                            | 1        | Grab data upon bit error.   |       |        |
|            |                                 | 0     | PHY_GRAB_DATA              |          | Transition from 0 to 1 causes logic to store current receive data from one lane.          | 0x0   | R/W    |
| 0x31F      | PHY_SNAPSHOT_DATA_BYTE0         | [7:0] | PHY_SNAPSHOT_DATA_BYTE0    |          | Current data received represents PHY_SNAPSHOT_DATA[7:0].                                  | 0x0   | R      |
| 0x320      | PHY_SNAPSHOT_DATA_BYTE1         | [7:0] | PHY_SNAPSHOT_DATA_BYTE1    |          | Current data received represents PHY_SNAPSHOT_DATA[15:8].                                 | 0x0   | R      |
| 0x321      | PHY_SNAPSHOT_DATA_BYTE2         | [7:0] | PHY_SNAPSHOT_DATA_BYTE2    |          | Current data received represents PHY_SNAPSHOT_DATA[23:16].                                | 0x0   | R      |
| 0x322      | PHY_SNAPSHOT_DATA_BYTE3         | [7:0] | PHY_SNAPSHOT_DATA_BYTE3    |          | Current data received represents PHY_SNAPSHOT_DATA[31:24].                                | 0x0   | R      |
| 0x323      | PHY_SNAPSHOT_DATA_BYTE4         | [7:0] | PHY_SNAPSHOT_DATA_BYTE4    |          | Current data received represents PHY_SNAPSHOT_DATA[39:32].                                | 0x0   | R      |
| 0x32C      | SHORT_TPL_TEST_0                | [7:4] | SHORT_TPL_SP_SEL           |          | Short transport layer sample selection. Select which sample to check from a specific DAC. | 0x0   | R/W    |
|            |                                 |       |                            | 0000     | Sample 0.   |       |        |
|            |                                 |       |                            | 0001     | Sample 1.   |       |        |
|            |                                 |       |                            | 0010     | Sample 2.   |       |        |
|            |                                 |       |                            | 0011     | Sample 3.   |       |        |



| Hex. Addr. | Name                  | Bits  | Bit Name             | Settings   | Description  | Reset | Access |
|------------|-----------------------|-------|----------------------|--|--|-------|--------|
|            |                       |       |                      | 0100<br>0101<br>0110<br>0111<br>1000<br>1001<br>1010<br>1011<br>1100<br>1101<br>1110<br>1111 | Sample 4.<br>Sample 5.<br>Sample 6.<br>Sample 7.<br>Sample 8.<br>Sample 9.<br>Sample 10.<br>Sample 11.<br>Sample 12.<br>Sample 13.<br>Sample 14.<br>Sample 15.   |       |        |
|            |                       | [3:2] | SHORT_TPL_M_SEL      | 00<br>01<br>10<br>11   | Short transport layer test DAC selection. Select which DAC to check.<br>DAC 0.<br>DAC 1.<br>DAC 2.<br>DAC 3.   | 0x0   | R/W    |
|            |                       | 1     | SHORT_TPL_TEST_RESET | 0<br>1   | Short transport layer test reset. Resets the result of short transport layer test.<br>Not reset.<br>Reset.   | 0x0   | R/W    |
|            |                       | 0     | SHORT_TPL_TEST_EN    | 0<br>1   | Short transport layer test enable. Enable short transport layer test.<br>Disable.<br>Enable.   | 0x0   | R/W    |
| 0x32D      | SHORT_TPL_TEST_1      | [7:0] | SHORT_TPL_REF_SP_LSB |  | Short transport layer reference sample LSB. This is the lower eight bits of expected DAC sample. It is used to compare with the received DAC sample at the output of JESD204B Rx.                        | 0x0   | R/W    |
| 0x32E      | SHORT_TPL_TEST_2      | [7:0] | SHORT_TPL_REF_SP_MSB |  | Short transport layer test reference sample MSB. This is the upper eight bits of expected DAC sample. It is used to compare with the received sample at JESD204B Rx output.                              | 0x0   | R/W    |
| 0x32F      | SHORT_TPL_TEST_3      | [7:1] | RESERVED             |  | Reserved.  | 0x0   | R      |
|            |                       | 0     | SHORT_TPL_FAIL       | 0<br>1   | Short transport layer test fail. This bit shows if the selected DAC sample matches the reference sample. If they match, the test passes; otherwise, the test fails.<br>Test pass.<br>Test fail.          | 0x0   | R      |
| 0x334      | JESD_BIT_INVERSE_CTRL | [7:0] | JESD_BIT_INVERSE     |  | Each bit of this byte inverts the JESD204B deserialized data from one specific JESD204B Rx PHY. The bit order matches the logical lane order. For example, Bit 0 controls Lane 0, Bit 1 controls Lane 1. | 0x0   | R/W    |

| Hex. Addr. | Name      | Bits  | Bit Name  | Settings | Description   | Reset | Access |
|------------|-----------|-------|-----------|----------|---|-------|--------|
| 0x400      | DID_REG   | [7:0] | DID_RD    |          | Received ILAS configuration on Lane 0. DID is the device ID number. Link information received on Lane 0 as specified in Section 8.3 of JESD204B.  | 0x0   | R      |
| 0x401      | BID_REG   | [7:0] | BID_RD    |          | Received ILAS configuration on Lane 0. BID is the bank ID, extension to DID. Link information received on Lane 0 as specified in Section 8.3 of JESD204B.   | 0x0   | R      |
| 0x402      | LID0_REG  | 7     | RESERVED  |          | Reserved.   | 0x0   | R      |
|            |           | 6     | ADJDIR_RD |          | Received ILAS configuration on Lane 0. ADJDIR is the direction to adjust the DAC LMFC. Link information received on Lane 0 as specified in Section 8.3 of JESD204B.   | 0x0   | R      |
|            |           | 5     | PHADJ_RD  |          | Received ILAS configuration on Lane 0. PHADJ is the phase adjustment request to DAC. Link information received on Lane 0 as specified in Section 8.3 of JESD204B.   | 0x0   | R      |
|            |           | [4:0] | LL_LID0   |          | Received ILAS LID configuration on Lane 0. LID0 is the lane identification for Lane 0. Link information received on Lane 0 as specified in Section 8.3 of JESD204B.   | 0x0   | R      |
| 0x403      | SCR_L_REG | 7     | SCR_RD    |          | Received ILAS configuration on Lane 0. SCR is the Tx scrambling status. Link information received on Lane 0 as specified in Section 8.3 of JESD204B.<br>0 Scrambling is disabled.<br>1 Scrambling is enabled.   | 0x0   | R      |
|            |           | [6:5] | RESERVED  |          | Reserved.   | 0x0   | R      |
|            |           | [4:0] | L_RD      |          | Received ILAS configuration on Lane 0. L is the number of lanes per converter device. Link information received on Lane 0 as specified in Section 8.3 of JESD204B.<br>00000 1 lane per converter device.<br>00001 2 lanes per converter device.<br>00011 4 lanes per converter device.<br>00111 8 lanes per converter device. | 0x0   | R      |
| 0x404      | F_REG     | [7:0] | F_RD      |          | Received ILAS configuration on Lane 0. F is the number of octets per frame. Settings of 1, 2, and 4 are valid (value in register is F – 1). Link information received on Lane 0 as specified in Section 8.3 of JESD204B.<br>0 1 octet per frame.<br>1 2 octets per frame.<br>11 4 octets per frame.                           | 0x0   | R      |

| Hex. Addr. | Name     | Bits  | Bit Name     | Settings       | Description  | Reset | Access |
|------------|----------|-------|--------------|----------------|--|-------|--------|
| 0x405      | K_REG    | [7:5] | RESERVED     |                | Reserved.  | 0x0   | R      |
|            |          | [4:0] | K_RD         | 01111<br>11111 | Received ILAS configuration on Lane 0. K is the number of frames per multiframe. Settings of 16 or 32 are valid. On this device, all modes use K = 32 (value in register is K – 1). Link information received on Lane 0 as specified in Section 8.3 of JESD204B.<br>16 frames per multiframe.<br>32 frames per multiframe. | 0x0   | R      |
| 0x406      | M_REG    | [7:0] | M_RD         |                | Received ILAS configuration on Lane 0. M is the number of converters per device. Link information received on Lane 0 as specified in Section 8.3 of JESD204B. M is 1 for real interface and 2 for complex interface (value in register is M – 1).  | 0x0   | R      |
| 0x407      | CS_N_REG | [7:6] | CS_RD        |                | Received ILAS configuration on Lane 0. CS is the number of control bits per sample. Link information received on Lane 0 as specified in Section 8.3 of JESD204B. CS is always 0 on this device.  | 0x0   | R      |
|            |          | 5     | RESERVED     |                | Reserved.  | 0x0   | R      |
|            |          | [4:0] | N_RD         |                | Received ILAS configuration on Lane 0. N is the converter resolution. Value in register is N – 1 (for example, 16 bits = 0b01111).   | 0x0   | R      |
| 0x408      | NP_REG   | [7:5] | SUBCLASSV_RD | 000<br>001     | Received ILAS configuration on Lane 0. SUBCLASSV is the device subclass version. Link information received on Lane 0 as specified in Section 8.3 of JESD204B.<br>Subclass 0.<br>Subclass 1.  | 0x0   | R      |
|            |          | [4:0] | NP_RD        |                | Received ILAS configuration on Lane 0. NP is the total number of bits per sample. Link information received on Lane 0 as specified in Section 8.3 of JESD204B. Value in register is NP – 1, for example, 16 bits per sample = 0b01111.   | 0x0   | R      |
| 0x409      | S_REG    | [7:5] | JESDV_RD     | 000<br>001     | Received ILAS configuration on Lane 0. JESDV is the JESD204x version. Link information received on Lane 0 as specified in Section 8.3 of JESD204B.<br>JESD204A.<br>JESD204B.   | 0x0   | R      |
|            |          | [4:0] | S_RD         |                | Received ILAS configuration on Lane 0. S is the number of samples per converter per frame cycle. Link information received on Lane 0 as specified in Section 8.3 of JESD204B. Value in register is S – 1.  | 0x0   | R      |

| Hex. Addr. | Name          | Bits  | Bit Name | Settings | Description  | Reset | Access |
|------------|---------------|-------|----------|----------|--|-------|--------|
| 0x40A      | HD_CF_REG     | 7     | HD_RD    |          | Received ILAS configuration on Lane 0. HD is the high density format. Refer to Section 5.1.3 of JESD204B standard. Link information received on Lane 0 as specified in Section 8.3 of JESD204B.<br>0 Low density mode.<br>1 High density mode.   | 0x0   | R      |
|            |               | [6:5] | RESERVED |          | Reserved.  | 0x0   | R      |
|            |               | [4:0] | CF_RD    |          | Received ILAS configuration on Lane 0. CF is the number of control words per frame clock period per link. Link information received on Lane 0 as specified in Section 8.3 of JESD204B. CF is always 0 on this device.  | 0x0   | R      |
| 0x40B      | RES1_REG      | [7:0] | RES1_RD  |          | Received ILAS configuration on Lane 0. Reserved Field 1. Link information received on Lane 0 as specified in Section 8.3 of JESD204B.  | 0x0   | R      |
| 0x40C      | RES2_REG      | [7:0] | RES2_RD  |          | Received ILAS configuration on Lane 0. Reserved Field 2. Link information received on Lane 0 as specified in Section 8.3 of JESD204B.  | 0x0   | R      |
| 0x40D      | CHECKSUM0_REG | [7:0] | LL_FCHK0 |          | Received checksum during ILAS on Lane 0. Checksum for Lane 0. Link information received on Lane 0 as specified in Section 8.3 of JESD204B.   | 0x0   | R      |
| 0x40E      | COMPSUM0_REG  | [7:0] | LL_FCMP0 |          | Computed checksum on Lane 0. Computed checksum for Lane 0. The JESD204B Rx computes the checksum of the link information received on Lane 0 as specified in Section 8.3 of JESD204B. The computation method is set by the CHECKSUM_MODE bit (Register 0x300, Bit 6) and must match the likewise calculated checksum in Register 0x40D. | 0x0   | R      |
| 0x412      | LID1_REG      | [7:5] | RESERVED |          | Reserved.  | 0x0   | R      |
|            |               | [4:0] | LL_LID1  |          | Received ILAS LID configuration on Lane 1. Lane identification for Lane 1. Link information received on Lane 0 as specified in Section 8.3 of JESD204B.  | 0x0   | R      |
| 0x415      | CHECKSUM1_REG | [7:0] | LL_FCHK1 |          | Received checksum during ILAS on lane 1. Checksum for Lane 1. Link information received on Lane 0 as specified in Section 8.3 of JESD204B.   | 0x0   | R      |
| 0x416      | COMPSUM1_REG  | [7:0] | LL_FCMP1 |          | Computed checksum on Lane 1. Computed checksum for Lane 1 (see description for Register 0x40E).  | 0x0   | R      |
| 0x41A      | LID2_REG      | [7:5] | RESERVED |          | Reserved.  | 0x0   | R      |
|            |               | [4:0] | LL_LID2  |          | Received ILAS LID configuration on Lane 2. Lane identification for Lane 2.   | 0x0   | R      |
| 0x41D      | CHECKSUM2_REG | [7:0] | LL_FCHK2 |          | Received checksum during ILAS on Lane 2. Checksum for Lane 2.  | 0x0   | R      |

| Hex. Addr. | Name          | Bits  | Bit Name | Settings | Description   | Reset | Access |
|------------|---------------|-------|----------|----------|---|-------|--------|
| 0x41E      | COMPSUM2_REG  | [7:0] | LL_FCMP2 |          | Computed checksum on Lane 2. Computed checksum for Lane 2 (see description for Register 0x40E). | 0x0   | R      |
| 0x422      | LID3_REG      | [7:5] | RESERVED |          | Reserved.   | 0x0   | R      |
|            |               | [4:0] | LL_LID3  |          | Received ILAS LID configuration on Lane 3. Lane identification for Lane 3.                      | 0x0   | R      |
| 0x425      | CHECKSUM3_REG | [7:0] | LL_FCHK3 |          | Received checksum during ILAS on Lane 3. Checksum for Lane 3.                                   | 0x0   | R      |
| 0x426      | COMPSUM3_REG  | [7:0] | LL_FCMP3 |          | Computed checksum on Lane 3. Computed checksum for Lane 3 (see description for Register 0x40E). | 0x0   | R      |
| 0x42A      | LID4_REG      | [7:5] | RESERVED |          | Reserved.   | 0x0   | R      |
|            |               | [4:0] | LL_LID4  |          | Received ILAS LID configuration on Lane 4. Lane identification for Lane 4.                      | 0x0   | R      |
| 0x42D      | CHECKSUM4_REG | [7:0] | LL_FCHK4 |          | Received checksum during ILAS on Lane 4. Checksum for Lane 4.                                   | 0x0   | R      |
| 0x42E      | COMPSUM4_REG  | [7:0] | LL_FCMP4 |          | Computed checksum on Lane 4. Computed checksum for Lane 4 (see description for Register 0x40E). | 0x0   | R      |
| 0x432      | LID5_REG      | [7:5] | RESERVED |          | Reserved.   | 0x0   | R      |
|            |               | [4:0] | LL_LID5  |          | Received ILAS LID configuration on Lane 5. Lane identification for Lane 5.                      | 0x0   | R      |
| 0x435      | CHECKSUM5_REG | [7:0] | LL_FCHK5 |          | Received checksum during ILAS on lane 5. Checksum for Lane 5.                                   | 0x0   | R      |
| 0x436      | COMPSUM5_REG  | [7:0] | LL_FCMP5 |          | Computed checksum on Lane 5. Computed checksum for Lane 5 (see description for Register 0x40E). | 0x0   | R      |
| 0x43A      | LID6_REG      | [7:5] | RESERVED |          | Reserved.   | 0x0   | R      |
|            |               | [4:0] | LL_LID6  |          | Received ILAS LID configuration on Lane 6. Lane identification for Lane 6.                      | 0x0   | R      |
| 0x43D      | CHECKSUM6_REG | [7:0] | LL_FCHK6 |          | Received checksum during ILAS on Lane 6. Checksum for Lane 6.                                   | 0x0   | R      |
| 0x43E      | COMPSUM6_REG  | [7:0] | LL_FCMP6 |          | Computed checksum on Lane 6. Computed checksum for Lane 6 (see description for Register 0x40E). | 0x0   | R      |
| 0x442      | LID7_REG      | [7:5] | RESERVED |          | Reserved.   | 0x0   | R      |
|            |               | [4:0] | LL_LID7  |          | Received ILAS LID configuration on Lane 7. Lane identification for Lane 7.                      | 0x0   | R      |
| 0x445      | CHECKSUM7_REG | [7:0] | LL_FCHK7 |          | Received checksum during ILAS on Lane 7. Checksum for Lane 7.                                   | 0x0   | R      |
| 0x446      | COMPSUM7_REG  | [7:0] | LL_FCMP7 |          | Computed checksum on Lane 5. Computed checksum for Lane 7 (see description for Register 0x40E). | 0x0   | R      |

| Hex. Addr. | Name      | Bits  | Bit Name | Settings | Description   | Reset | Access |
|------------|-----------|-------|----------|----------|---|-------|--------|
| 0x450      | ILS_DID   | [7:0] | DID      |          | Device (= link) identification number. DID is the device ID number. Link information received on Lane 0 as specified in Section 8.3 of JESD204B. Must be set to the value read in Register 0x400. This signal must only be programmed while the QBD is held in soft reset (Register 0x475, Bit 3), and must not be changed during normal operation. | 0x0   | R/W    |
| 0x451      | ILS_BID   | [7:0] | BID      |          | Bank ID, extension to DID. This signal must only be programmed while the QBD is held in soft reset (Register 0x475, Bit 3), and must not be changed during normal operation.  | 0x0   | R/W    |
| 0x452      | ILS_LID0  | 7     | RESERVED |          | Reserved.   | 0x0   | R      |
|            |           | 6     | ADJDIR   |          | Direction to adjust DAC LMFC (Subclass 2 only). ADJDIR is the direction to adjust DAC LMFC. Link information received on Lane 0 as specified in Section 8.3 of JESD204B. This signal must only be programmed while the QBD is held in soft reset (Register 0x475, Bit 3), and must not be changed during normal operation.                          | 0x0   | R/W    |
|            |           | 5     | PHADJ    |          | Phase adjustment to DAC (Subclass 2 only). PHADJ is the phase adjustment request to the DAC. Link information received on Lane 0 as specified in Section 8.3 of JESD204B. This signal must only be programmed while the QBD is held in soft reset (Register 0x475, Bit 3), and must not be changed during normal operation.                         | 0x0   | R/W    |
|            |           | [4:0] | LID0     |          | Lane identification number (within link). LID0 is the lane identification for Lane 0. Link information received on Lane 0 as specified in Section 8.3 of JESD204B. This signal must only be programmed while the QBD is held in soft reset (Register 0x475, Bit 3), and must not be changed during normal operation.                                | 0x0   | R/W    |
| 0x453      | ILS_SCR_L | 7     | SCR      |          | Scramble enable. SCR is the Rx descrambling enable. This signal must only be programmed while the QBD is held in soft reset (Register 0x475, Bit 3), and must not be changed during normal operation.<br><br>0 Descrambling is disabled.<br>1 Descrambling is enabled.  | 0x1   | R/W    |
|            |           | [6:5] | RESERVED |          | Reserved.   | 0x0   | R      |

| Hex. Addr. | Name     | Bits  | Bit Name  | Settings          | Description   | Reset | Access |
|------------|----------|-------|-----------|-------------------|---|-------|--------|
|            |          | [4:0] | L         |                   | Number of lanes per converter (minus 1). L is the number of lanes per converter device. Settings of 1, 2, 3, 4, 6, and 8 are valid. Refer to Table 16 and Table 17.   | 0x7   | R      |
| 0x454      | ILS_F    | [7:0] | F         |                   | Number of octets per frame (minus 1). This value of F is not used to soft configure the QBD. Register CTRLREG1 is used to soft-configure the QBD.   | 0x0   | R      |
| 0x455      | ILS_K    | [7:5] | RESERVED  |                   | Reserved.   | 0x0   | R      |
|            |          | [4:0] | K         | 01111<br>11111    | Number of frames per multiframe (minus 1). K is the number of frames per multiframe. On this device, all modes use K = 32 (value in register is K – 1). This signal must only be programmed while the QBD is held in soft reset (Register 0x475, Bit 3), and must not be changed during normal operation.<br>16 frames per multiframe.<br>32 frames per multiframe. | 0x1F  | R/W    |
| 0x456      | ILS_M    | [7:0] | M         |                   | Number of converters per device (minus 1). M is the number of converters/device. Settings of 1 and 2 are valid. Refer to Table 16 and Table 17.   | 0x1   | R      |
| 0x457      | ILS_CS_N | [7:6] | CS        |                   | Number of control bits per sample. CS is the number of control bits per sample. Must be set to 0. Control bits are not supported.   | 0x0   | R      |
|            |          | 5     | RESERVED  |                   | Reserved.   | 0x0   | R      |
|            |          | [4:0] | N         |                   | Converter resolution (minus 1). N is the converter resolution. Must be set to 16 (0x0F).  | 0xF   | R      |
| 0x458      | ILS_NP   | [7:5] | SUBCLASSV | 000<br>001<br>010 | Device subclass version. SUBCLASSV is the device subclass version. This signal must only be programmed while the QBD is held in soft reset (Register 0x475, Bit 3), and must not be changed during normal operation.<br>Subclass 0.<br>Subclass 1.<br>Subclass 2 (not supported.)   | 0x0   | R/W    |
|            |          | [4:0] | NP        |                   | Total number of bits per sample (minus 1) NP is the total number of bits per sample. Must be set to 16 (0x0F). Refer to Table 16 and Table 17.  | 0xF   | R      |
| 0x459      | ILS_S    | [7:5] | JESDV     | 000<br>001        | JESD204x version. JESDV is the JESD204x version. This signal must only be programmed while the QBD is held in soft reset (Register 0x475, Bit 3), and must not be changed during normal operation.<br>JESD204A.<br>JESD204B.  | 0x0   | R/W    |

| Hex. Addr. | Name         | Bits  | Bit Name | Settings | Description  | Reset | Access |
|------------|--------------|-------|----------|----------|--|-------|--------|
|            |              | [4:0] | S        |          | Number of samples per converter per frame cycle (minus 1). S is the number of samples per converter per frame cycle. Settings of 1 and 2 are valid. Refer to Table 16 and Table 17.  | 0x1   | R      |
| 0x45A      | ILS_HD_CF    | 7     | HD       |          | High density format. HD is the high density mode. Refer to Section 5.1.3 of JESD204B standard.<br>0 Low density mode.<br>1 High density mode.  | 0x1   | R      |
|            |              | [6:5] | RESERVED |          | Reserved.  | 0x0   | R      |
|            |              | [4:0] | CF       |          | Number of control bits per sample. CF is the number of control words per frame clock period per link. Must be set to 0. Control bits are not supported.  | 0x0   | R      |
| 0x45B      | ILS_RES1     | [7:0] | RES1     |          | Reserved. Reserved Field 1. This signal must only be programmed while the QBD is held in soft reset (Register 0x475, Bit 3), and must not be changed during normal operation.  | 0x0   | R/W    |
| 0x45C      | ILS_RES2     | [7:0] | RES2     |          | Reserved. Reserved Field 2. This signal must only be programmed while the QBD is held in soft reset (Register 0x475, Bit 3), and must not be changed during normal operation.  | 0x0   | R/W    |
| 0x45D      | ILS_CHECKSUM | [7:0] | FCHK0    |          | Link configuration checksum. Checksum for Lane 0. The checksum for the configuration values (not the whole register content) programmed into Register 0x450 to Register 0x45C must be calculated according to Section 8.3 of the JESD204B specification and written to this register ( $SUM(DID, \dots, SC, L-1, \dots, CF) \% 256$ ). This signal must only be programmed while the QBD is held in soft reset (Register 0x475, Bit 3), and must not be changed during normal operation. | 0x0   | R/W    |
| 0x46C      | LANE_DESKEW  | 7     | ILD7     |          | Interlane deskew status for Lane 7 (ignore this output when NO_ILAS = 1).<br>0 Deskew failed.<br>1 Deskew achieved.  | 0x0   | R      |
|            |              | 6     | ILS6     |          | Initial lane synchronization status for Lane 6 (ignore this output when NO_ILAS = 1).<br>0 Synchronization lost.<br>1 Synchronization achieved.  | 0x0   | R      |
|            |              | 5     | ILD5     |          | Interlane deskew status for Lane 5 (ignore this output when NO_ILAS = 1).<br>0 Deskew failed.<br>1 Deskew achieved.  | 0x0   | R      |



| Hex. Addr. | Name          | Bits | Bit Name | Settings | Description   | Reset | Access |
|------------|---------------|------|----------|----------|---|-------|--------|
|            |               | 4    | ILD4     |          | Interlane deskew status for Lane 4 (ignore this output when NO_ILAS = 1).<br>0 Deskew failed.<br>1 Deskew achieved. | 0x0   | R      |
|            |               | 3    | ILD3     |          | Interlane deskew status for Lane 3 (ignore this output when NO_ILAS = 1).<br>0 Deskew failed.<br>1 Deskew achieved. | 0x0   | R      |
|            |               | 2    | ILD2     |          | Interlane deskew status for Lane 2 (ignore this output when NO_ILAS = 1).<br>0 Deskew failed.<br>1 Deskew achieved. | 0x0   | R      |
|            |               | 1    | ILD1     |          | Interlane deskew status for Lane 1 (ignore this output when NO_ILAS = 1).<br>0 Deskew failed.<br>1 Deskew achieved. | 0x0   | R      |
|            |               | 0    | ILD0     |          | Interlane deskew status for Lane 0 (ignore this output when NO_ILAS = 1).<br>0 Deskew failed.<br>1 Deskew achieved. | 0x0   | R      |
| 0x46D      | BAD_DISPARITY | 7    | BDE7     |          | Bad disparity error status for Lane 7.<br>0 Error count < ETH[7:0] value.<br>1 Error count ≥ ETH[7:0] value.        | 0x0   | R      |
|            |               | 6    | BDE6     |          | Bad disparity error status for Lane 6.<br>0 Error count < ETH[7:0] value.<br>1 Error count ≥ ETH[7:0] value.        | 0x0   | R      |
|            |               | 5    | BDE5     |          | Bad disparity errors status for Lane 5.<br>0 Error count < ETH[7:0] value.<br>1 Error count ≥ ETH[7:0] value.       | 0x0   | R      |
|            |               | 4    | BDE4     |          | Bad disparity error status for Lane 4.<br>0 Error count < ETH[7:0] value.<br>1 Error count ≥ ETH[7:0] value.        | 0x0   | R      |
|            |               | 3    | BDE3     |          | Bad disparity error status for Lane 3.<br>0 Error count < ETH[7:0] value.<br>1 Error count ≥ ETH[7:0] value.        | 0x0   | R      |
|            |               | 2    | BDE2     |          | Bad disparity error status for Lane 2.<br>0 Error count < ETH[7:0] value.<br>1 Error count ≥ ETH[7:0] value.        | 0x0   | R      |
|            |               | 1    | BDE1     |          | Bad disparity error status for Lane 1.<br>0 Error count < ETH[7:0] value.<br>1 Error count ≥ ETH[7:0] value.        | 0x0   | R      |
|            |               | 0    | BDE0     |          | Bad disparity error status for Lane 0.<br>0 Error count < ETH[7:0] value.<br>1 Error count ≥ ETH[7:0] value.        | 0x0   | R      |

| Hex. Addr. | Name             | Bits | Bit Name | Settings | Description   | Reset | Access |
|------------|------------------|------|----------|----------|---|-------|--------|
| 0x46E      | NOT_IN_TABLE     | 7    | NIT7     |          | Not in table error status for Lane 7.<br>0 Error count < ETH[7:0] value.<br>1 Error count ≥ ETH[7:0] value.           | 0x0   | R      |
|            |                  | 6    | NIT6     |          | Not in table error status for Lane 6.<br>0 Error count < ETH[7:0] value.<br>1 Error count ≥ ETH[7:0] value.           | 0x0   | R      |
|            |                  | 5    | NIT5     |          | Not in table errors status for Lane 5.<br>0 Error count < ETH[7:0] value.<br>1 Error count ≥ ETH[7:0] value.          | 0x0   | R      |
|            |                  | 4    | NIT4     |          | Not in table error status for Lane 4.<br>0 Error count < ETH[7:0] value.<br>1 Error count ≥ ETH[7:0] value.           | 0x0   | R      |
|            |                  | 3    | NIT3     |          | Not in table error status for Lane 3.<br>0 Error count < ETH[7:0] value.<br>1 Error count ≥ ETH[7:0] value.           | 0x0   | R      |
|            |                  | 2    | NIT2     |          | Not in table error status for Lane 2.<br>0 Error count < ETH[7:0] value.<br>1 Error count ≥ ETH[7:0] value.           | 0x0   | R      |
|            |                  | 1    | NIT1     |          | Not in table error status for Lane 1.<br>0 Error count < ETH[7:0] value.<br>1 Error count ≥ ETH[7:0] value.           | 0x0   | R      |
|            |                  | 0    | NIT0     |          | Not in table error status for Lane 0.<br>0 Error count < ETH[7:0] value.<br>1 Error count ≥ ETH[7:0] value.           | 0x0   | R      |
| 0x46F      | UNEXPECTED_KCHAR | 7    | UEK7     |          | Unexpected K character error status for Lane 7.<br>0 Error count < ETH[7:0] value.<br>1 Error count ≥ ETH[7:0] value. | 0x0   | R      |
|            |                  | 6    | UEK6     |          | Unexpected K character error status for Lane 6.<br>0 Error count < ETH[7:0] value.<br>1 Error count ≥ ETH[7:0] value. | 0x0   | R      |
|            |                  | 5    | UEK5     |          | Unexpected K character error status for Lane 5.<br>0 Error count < ETH[7:0] value.<br>1 Error count ≥ ETH[7:0] value. | 0x0   | R      |
|            |                  | 4    | UEK4     |          | Unexpected K character error status for Lane 4.<br>0 Error count < ETH[7:0] value.<br>1 Error count ≥ ETH[7:0] value. | 0x0   | R      |
|            |                  | 3    | UEK3     |          | Unexpected K character error status for Lane 3.<br>0 Error count < ETH[7:0] value.<br>1 Error count ≥ ETH[7:0] value. | 0x0   | R      |
|            |                  | 2    | UEK2     |          | Unexpected K character error status for Lane 2.<br>0 Error count < ETH[7:0] value.<br>1 Error count ≥ ETH[7:0] value. | 0x0   | R      |
|            |                  | 1    | UEK1     |          | Unexpected K character error status for Lane 1.<br>0 Error count < ETH[7:0] value.<br>1 Error count ≥ ETH[7:0] value. | 0x0   | R      |

| Hex. Addr. | Name          | Bits | Bit Name | Settings | Description   | Reset | Access |
|------------|---------------|------|----------|----------|---|-------|--------|
|            |               | 0    | UEK0     |          | Unexpected K character error status for Lane 0.<br>0 Error count < ETH[7:0] value.<br>1 Error count ≥ ETH[7:0] value.         | 0x0   | R      |
| 0x470      | CODE_GRP_SYNC | 7    | CGS7     |          | Code group sync status for Lane 7.<br>0 Synchronization lost.<br>1 Synchronization achieved.                                  | 0x0   | R      |
|            |               | 6    | CGS6     |          | Code group sync status for Lane 6.<br>0 Synchronization lost.<br>1 Synchronization achieved.                                  | 0x0   | R      |
|            |               | 5    | CGS5     |          | Code group sync status for Lane 5.<br>0 Synchronization lost.<br>1 Synchronization achieved.                                  | 0x0   | R      |
|            |               | 4    | CGS4     |          | Code group sync status for Lane 4.<br>0 Synchronization lost.<br>1 Synchronization achieved.                                  | 0x0   | R      |
|            |               | 3    | CGS3     |          | Code group sync status for Lane 3.<br>0 Synchronization lost.<br>1 Synchronization achieved.                                  | 0x0   | R      |
|            |               | 2    | CGS2     |          | Code group sync status for Lane 2.<br>0 Synchronization lost.<br>1 Synchronization achieved.                                  | 0x0   | R      |
|            |               | 1    | CGS1     |          | Code group sync status for Lane 1.<br>0 Synchronization lost.<br>1 Synchronization achieved.                                  | 0x0   | R      |
|            |               | 0    | CGS0     |          | Code group sync status for Lane 0.<br>0 Synchronization lost.<br>1 Synchronization achieved.                                  | 0x0   | R      |
| 0x471      | FRAME_SYNC    | 7    | FS7      |          | Frame sync status for Lane 7 (ignore this output when NO_ILAS = 1).<br>0 Synchronization lost.<br>1 Synchronization achieved. | 0x0   | R      |
|            |               | 6    | FS6      |          | Frame sync status for Lane 6 (ignore this output when NO_ILAS = 1).<br>0 Synchronization lost.<br>1 Synchronization achieved. | 0x0   | R      |
|            |               | 5    | FS5      |          | Frame sync status for Lane 5 (ignore this output when NO_ILAS = 1).<br>0 Synchronization lost.<br>1 Synchronization achieved. | 0x0   | R      |
|            |               | 4    | FS4      |          | Frame sync status for Lane 4 (ignore this output when NO_ILAS = 1).<br>0 Synchronization lost.<br>1 Synchronization achieved. | 0x0   | R      |

| Hex. Addr. | Name          | Bits | Bit Name | Settings | Description  | Reset | Access |
|------------|---------------|------|----------|----------|--|-------|--------|
|            |               | 3    | FS3      |          | Frame sync status for Lane 3 (ignore this output when NO_ILAS = 1).<br>0 Synchronization lost.<br>1 Synchronization achieved.    | 0x0   | R      |
|            |               | 2    | FS2      |          | Frame sync status for Lane 2 (ignore this output when NO_ILAS = 1).<br>0 Synchronization lost.<br>1 Synchronization achieved.    | 0x0   | R      |
|            |               | 1    | FS1      |          | Frame sync status for Lane 1 (ignore this output when NO_ILAS = 1).<br>0 Synchronization lost.<br>1 Synchronization achieved.    | 0x0   | R      |
|            |               | 0    | FS0      |          | Frame sync status for Lane 0 (ignore this output when NO_ILAS = 1).<br>0 Synchronization lost.<br>1 Synchronization achieved.    | 0x0   | R      |
| 0x472      | GOOD_CHECKSUM | 7    | CKS7     |          | Computed checksum status for Lane 7 (ignore this output when NO_ILAS = 1).<br>0 Checksum is incorrect.<br>1 Checksum is correct. | 0x0   | R      |
|            |               | 6    | CKS6     |          | Computed checksum status for Lane 6 (ignore this output when NO_ILAS = 1).<br>0 Checksum is incorrect.<br>1 Checksum is correct. | 0x0   | R      |
|            |               | 5    | CKS5     |          | Computed checksum status for Lane 5 (ignore this output when NO_ILAS = 1).<br>0 Checksum is incorrect.<br>1 Checksum is correct. | 0x0   | R      |
|            |               | 4    | CKS4     |          | Computed checksum status for Lane 4 (ignore this output when NO_ILAS = 1).<br>0 Checksum is incorrect.<br>1 Checksum is correct. | 0x0   | R      |
|            |               | 3    | CKS3     |          | Computed checksum status for Lane 3 (ignore this output when NO_ILAS = 1).<br>0 Checksum is incorrect.<br>1 Checksum is correct. | 0x0   | R      |
|            |               | 2    | CKS2     |          | Computed checksum status for Lane 2 (ignore this output when NO_ILAS = 1).<br>0 Checksum is incorrect.<br>1 Checksum is correct. | 0x0   | R      |
|            |               | 1    | CKS1     |          | Computed checksum status for Lane 1 (ignore this output when NO_ILAS = 1).<br>0 Checksum is incorrect.<br>1 Checksum is correct. | 0x0   | R      |

| Hex. Addr. | Name           | Bits | Bit Name | Settings | Description  | Reset | Access |
|------------|----------------|------|----------|----------|--|-------|--------|
|            |                | 0    | CKS0     |          | Computed checksum status for Lane 0 (ignore this output when NO_ILAS = 1).<br>0 Checksum is incorrect.<br>1 Checksum is correct.   | 0x0   | R      |
| 0x473      | INIT_LANE_SYNC | 7    | ILS7     |          | Initial lane synchronization status for Lane 7 (ignore this output when NO_ILAS = 1).<br>0 Synchronization lost.<br>1 Synchronization achieved.  | 0x0   | R      |
|            |                | 6    | ILS6     |          | Initial lane synchronization status for Lane 6 (ignore this output when NO_ILAS = 1).<br>0 Synchronization lost.<br>1 Synchronization achieved.  | 0x0   | R      |
|            |                | 5    | ILS5     |          | Initial lane synchronization status for Lane 5 (ignore this output when NO_ILAS = 1).<br>0 Synchronization lost.<br>1 Synchronization achieved.  | 0x0   | R      |
|            |                | 4    | ILS4     |          | Initial lane synchronization status for Lane 4 (ignore this output when NO_ILAS = 1).<br>0 Synchronization lost.<br>1 Synchronization achieved.  | 0x0   | R      |
|            |                | 3    | ILS3     |          | Initial lane synchronization status for Lane 3 (ignore this output when NO_ILAS = 1).<br>0 Synchronization lost.<br>1 Synchronization achieved.  | 0x0   | R      |
|            |                | 2    | ILS2     |          | Initial lane synchronization status for Lane 2 (ignore this output when NO_ILAS = 1).<br>0 Synchronization lost.<br>1 Synchronization achieved.  | 0x0   | R      |
|            |                | 1    | ILS1     |          | Initial lane synchronization status for Lane 1 (ignore this output when NO_ILAS = 1).<br>0 Synchronization lost.<br>1 Synchronization achieved.  | 0x0   | R      |
|            |                | 0    | ILS0     |          | Initial lane synchronization status for Lane 0 (ignore this output when NO_ILAS = 1).<br>0 Synchronization lost.<br>1 Synchronization achieved.  | 0x0   | R      |
| 0x475      | CTRLREG0       | 7    | RX_DIS   |          | Level input: disable deframer receiver when this input = 1. This signal must only be programmed while the QBD is held in soft reset (Register 0x475, Bit 3), and must not be changed during normal operation.<br>1 Disable character replacement of /A/ and /F/ control characters at the end of received frames and multiframes.<br>0 Enables the substitution. | 0x0   | R/W    |

| Hex. Addr. | Name     | Bits  | Bit Name      | Settings | Description  | Reset | Access |
|------------|----------|-------|---------------|----------|--|-------|--------|
|            |          | 6     | CHAR_REPL_DIS |          | When this input = 1, character replacement at the end of frame/multiframe is disabled. This signal must only be programmed while the QBD is held in soft reset (Register 0x475, Bit 3), and must not be changed during normal operation.   | 0x0   | R/W    |
|            |          | [5:4] | RESERVED      |          | Reserved.  | 0x0   | R      |
|            |          | 3     | SOFTRST       |          | Soft reset. Active high synchronous reset. Resets all hardware to power-on state.<br><br>1 Disables the deframer reception.<br>0 Enable deframer logic.  | 0x0   | R/W    |
|            |          | 2     | FORCESYNCREQ  |          | Command from application to assert a sync request (SYNCOUT). Active high.  | 0x0   | R/W    |
|            |          | 1     | RESERVED      |          | Reserved.  | 0x0   | R      |
|            |          | 0     | REPL_FRM_ENA  |          | When this level input is set, it enables replacement of frames received in error. This signal must only be programmed while the QBD is held in soft reset (Register 0x475, Bit 3), and must not be changed during normal operation.  | 0x1   | R/W    |
| 0x476      | CTRLREG1 | [7:5] | RESERVED      |          | Reserved.  | 0x0   | R      |
|            |          | 4     | QUAL_RDERR    |          | Error reporting behavior for concurrent NIT and RD errors. This signal must only be programmed while the QBD is held in soft reset (Register 0x475, Bit 3), and must not be changed during normal operation.<br><br>0 NIT has no effect on RD error.<br>1 NIT error masks concurrent RD error.   | 0x1   | R/W    |
|            |          | 3     | DEL_SCR       |          | Alternative descrambler enable. (see JESD204B Section 5.2.4) This signal must only be programmed while the QBD is held in soft reset (Register 0x475, Bit 3), and must not be changed during normal operation.<br><br>1 Descrambling begins at Octet 2 of user data.<br>0 Descrambling begins at Octet 0 of user data. This is the common usage.                       | 0x0   | R/W    |
|            |          | 2     | CGS_SEL       |          | Determines the QBD behavior after code group sync has been achieved. This signal must only be programmed while the QBD is held in soft reset (Register 0x475, Bit 3), and must not be changed during normal operation.<br><br>0 After code group sync is achieved, the QBD asserts SYNCOUT only if there are sufficient disparity errors as per the JESD204B standard. | 0x1   | R/W    |

| Hex. Addr. | Name     | Bits | Bit Name    | Settings | Description   | Reset | Access |
|------------|----------|------|-------------|----------|---|-------|--------|
|            |          |      |             |          | 1 After code group sync is achieved, if a /K/ is followed by any character other than an /R/ or another /K/, QBD asserts SYNCOUT.   |       |        |
|            |          | 1    | NO_ILAS     |          | <p>This signal must only be programmed while the QBD is held in soft reset (Register 0x475, Bit 3), and must not be changed during normal operation.</p> <p>1 For single-lane operation, ILAS is omitted. Code group sync is followed by user data.</p> <p>0 Code group sync is followed by ILAS. For multilane operation, NO_ILAS must always be set to 0.</p>   | 0x0   | R/W    |
|            |          | 0    | FCHK_N      |          | <p>Checksum calculation method. This signal must only be programmed while the QBD is held in soft reset (Register 0x475, Register 3), and must not be changed during normal operation.</p> <p>0 Calculate checksum by summing individual fields (this more closely matches the definition of the checksum field in the JESD204B standard).</p> <p>1 Calculate checksum by summing the registers containing the packed fields (this setting is provided in case the framer of another vendor performs the calculation with this method).</p> | 0x0   | R/W    |
| 0x477      | CTRLREG2 | 7    | ILS_MODE    |          | <p>Data link layer test mode. This signal must only be programmed while the QBD is held in soft reset (Register 0x475, Bit 3), and must not be changed during normal operation.</p> <p>0 Normal mode.</p> <p>1 Code group sync pattern is followed by a perpetual ILAS sequence.</p>  | 0x0   | R/W    |
|            |          | 6    | RESERVED    |          | Reserved.   | 0x0   | R      |
|            |          | 5    | REPDATATEST |          | <p>Repetitive data test enable, using JTSPAT pattern. To enable the test, ILS_MODE must = 0. This signal must only be programmed while the QBD is held in soft reset (Register 0x475, Bit 3), and must not be changed during normal operation.</p>  | 0x0   | R/W    |
|            |          | 4    | QUETESTERR  |          | <p>Queue test error mode. This signal must only be programmed while the QBD is held in soft reset (Register 0x475, Bit 3), and must not be changed during normal operation.</p>   | 0x0   | R/W    |

| Hex. Addr. | Name             | Bits  | Bit Name         | Settings | Description  | Reset | Access |
|------------|------------------|-------|------------------|----------|--|-------|--------|
|            |                  |       |                  | 0        | Simultaneous errors on multiple lanes are reported as one error.   |       |        |
|            |                  |       |                  | 1        | Detected errors from all lanes are trapped in a counter and sequentially signaled on SYNCOUT.  |       |        |
|            |                  | 3     | AR_ECNTN         |          | Automatic reset of error counter. The error counter that causes assertion of SYNCOUT is automatically reset to 0 when AR_ECNTN = 1. All other counters are unaffected. This signal must only be programmed while the QBD is held in soft reset (Register 0x475, Bit 3), and must not be changed during normal operation.   | 0x0   | R/W    |
|            |                  | [2:0] | RESERVED         |          | Reserved.  | 0x0   | R      |
| 0x478      | KVAL             | [7:0] | KSYNC            |          | Number of $4 \times K$ multiframes during ILS. F is the number of octets per frame. Settings of 1, 2, and 4 are valid. Refer to Table 16 and Table 17. This signal must only be programmed while the QBD is held in soft reset (Register 0x475, Bit 3), and must not be changed during normal operation.   | 0x1   | R/W    |
| 0x47C      | ERRORTHRES       | [7:0] | ETH              |          | Error threshold value. Bad disparity, NIT disparity, and unexpected K character errors are counted and compared to the error threshold value. When the count is equal, either an IRQ is generated or SYNCOUT± is asserted per the mask register settings or both. Function is performed in all lanes. This signal must only be programmed while the QBD is held in soft reset (Register 0x475, Bit 3), and must not be changed during normal operation.  | 0xFF  | R/W    |
| 0x47D      | SYNC_ASSERT_MASK | [7:3] | RESERVED         |          | Reserved.  | 0x0   | R      |
|            |                  | [2:0] | SYNC_ASSERT_MASK |          | SYNCOUT assertion enable mask for BD, NIT, and UEK error conditions. Active high, SYNCOUT assertion enable mask for BD, NIT, and UEK error conditions, respectively. When an error counter, in any lane, has reached the error threshold count, ETH[7:0], and the corresponding SYNC_ASSERT_MASK bit is set, SYNCOUT is asserted. The mask bits are as follows. Note that the bit sequence is reversed with respect to the other error count controls and the error counters. Bit 2 = bad disparity error (BDE). | 0x7   | R/W    |



| Hex. Addr. | Name       | Bits  | Bit Name  | Settings | Description  | Reset | Access |
|------------|------------|-------|-----------|----------|--|-------|--------|
|            |            |       |           |          | Bit 1 = not in table error (NIT).<br>Bit 0 = unexpected K (UEK) character error.   |       |        |
| 0x480      | ECNT_CTRL0 | [7:6] | RESERVED  |          | Reserved.  | 0x0   | R      |
|            |            | [5:3] | ECNT_ENA0 |          | Error counter enable for Lane 0. Counters of each lane are addressed as follows:<br>Bit 2 = unexpected K (UEK) character error.<br>Bit 1 = not in table error (NIT).<br>Bit 0 = bad disparity error (BDE).               | 0x7   | R/W    |
|            |            | [2:0] | ECNT_RST0 |          | Error counters enable for Lane 0, active high. Counters of each lane are addressed as follows:<br>Bit 2 = unexpected K (UEK) character error.<br>Bit 1 = not in table error (NIT).<br>Bit 0 = bad disparity error (BDE). | 0x7   | R/W    |
| 0x481      | ECNT_CTRL1 | [7:6] | RESERVED  |          | Reserved.  | 0x0   | R      |
|            |            | [5:3] | ECNT_ENA1 |          | Error counters enable for Lane 1, active high. Counters of each lane are addressed as follows:<br>Bit 2 = unexpected K (UEK) character error.<br>Bit 1 = not in table error (NIT).<br>Bit 0 = bad disparity error (BDE). | 0x7   | R/W    |
|            |            | [2:0] | ECNT_RST1 |          | Error counters enable for Lane 1, active high. Counters of each lane are addressed as follows:<br>Bit 2 = unexpected K (UEK) character error.<br>Bit 1 = not in table error (NIT).<br>Bit 0 = bad disparity error (BDE). | 0x7   | R/W    |
| 0x482      | ECNT_CTRL2 | [7:6] | RESERVED  |          | Reserved.  | 0x0   | R      |
|            |            | [5:3] | ECNT_ENA2 |          | Error counters enable for Lane 2, active high. Counters of each lane are addressed as follows:<br>Bit 2 = unexpected K (UEK) character error.<br>Bit 1 = not in table error (NIT).<br>Bit 0 = bad disparity error (BDE). | 0x7   | R/W    |
|            |            | [2:0] | ECNT_RST2 |          | Error counters enable for Lane 2, active high. Counters of each lane are addressed as follows:<br>Bit 2 = unexpected K (UEK) character error.<br>Bit 1 = not in table error (NIT).<br>Bit 0 = bad disparity error (BDE). | 0x7   | R/W    |
| 0x483      | ECNT_CTRL3 | [7:6] | RESERVED  |          | Reserved.  | 0x0   | R      |
|            |            | [5:3] | ECNT_ENA3 |          | Error counters enable for Lane 3, active high. Counters of each lane are addressed as follows:<br>Bit 2 = unexpected K (UEK) character error.<br>Bit 1 = not in table error (NIT).<br>Bit 0 = bad disparity error (BDE). | 0x7   | R/W    |
|            |            | [2:0] | ECNT_RST3 |          | Error counters enable for Lane 3, active high. Counters of each lane are addressed as follows:   | 0x7   | R/W    |

| Hex. Addr. | Name       | Bits  | Bit Name  | Settings | Description  | Reset | Access |
|------------|------------|-------|-----------|----------|--|-------|--------|
|            |            |       |           |          | Bit 2 = unexpected K (UEK) character error.<br>Bit 1 = not in table error (NIT).<br>Bit 0 = bad disparity error (BDE).   |       |        |
| 0x484      | ECNT_CTRL4 | [7:6] | RESERVED  |          | Reserved.  | 0x0   | R      |
|            |            | [5:3] | ECNT_ENA4 |          | Error counters enable for Lane 4, active high. Counters of each lane are addressed as follows:<br>Bit 2 = unexpected K (UEK) character error.<br>Bit 1 = not in table error (NIT).<br>Bit 0 = bad disparity error (BDE). | 0x7   | R/W    |
|            |            | [2:0] | ECNT_RST4 |          | Error counters enable for Lane 4, active high. Counters of each lane are addressed as follows:<br>Bit 2 = unexpected K (UEK) character error.<br>Bit 1 = not in table error (NIT).<br>Bit 0 = bad disparity error (BDE). | 0x7   | R/W    |
| 0x485      | ECNT_CTRL5 | [7:6] | RESERVED  |          | Reserved.  | 0x0   | R      |
|            |            | [5:3] | ECNT_ENA5 |          | Error counters enable for Lane 5, active high. Counters of each lane are addressed as follows:<br>Bit 2 = unexpected K (UEK) character error.  | 0x7   | R/W    |
|            |            |       |           |          | Bit 1 = not in table error (NIT).<br>Bit 0 = bad disparity error (BDE).  |       |        |
|            |            | [2:0] | ECNT_RST5 |          | Error counters enable for Lane 5, active high. Counters of each lane are addressed as follows:<br>Bit 2 = unexpected K (UEK) character error.<br>Bit 1 = not in table error (NIT).<br>Bit 0 = bad disparity error (BDE). | 0x7   | R/W    |
| 0x486      | ECNT_CTRL6 | [7:6] | RESERVED  |          | Reserved.  | 0x0   | R      |
|            |            | [5:3] | ECNT_ENA6 |          | Error counters enable for Lane 6, active high. Counters of each lane are addressed as follows:<br>Bit 2 = unexpected K (UEK) character error.<br>Bit 1 = not in table error (NIT).<br>Bit 0 = bad disparity error (BDE). | 0x7   | R/W    |
|            |            | [2:0] | ECNT_RST6 |          | Error counters enable for Lane 6, active high. Counters of each lane are addressed as follows:<br>Bit 2 = unexpected K (UEK) character error.<br>Bit 1 = not in table error (NIT).<br>Bit 0 = bad disparity error (BDE). | 0x7   | R/W    |
| 0x487      | ECNT_CTRL7 | [7:6] | RESERVED  |          | Reserved.  | 0x0   | R      |
|            |            | [5:3] | ECNT_ENA7 |          | Error counters enable for Lane 7, active high. Counters of each lane are addressed as follows:<br>Bit 2 = unexpected K (UEK) character error.<br>Bit 1 = not in table error (NIT).<br>Bit 0 = bad disparity error (BDE). | 0x7   | R/W    |

| Hex. Addr. | Name      | Bits  | Bit Name  | Settings | Description   | Reset | Access |
|------------|-----------|-------|-----------|----------|---|-------|--------|
|            |           | [2:0] | ECNT_RST7 |          | Reset error counters for Lane 7, active high. Counters of each lane are addressed as follows:<br>Bit 2 = unexpected K (UEK) character error.<br>Bit 1 = not in table error (NIT).<br>Bit 0 = bad disparity error (BDE).   | 0x7   | R/W    |
| 0x488      | ECNT_TCH0 | [7:3] | RESERVED  |          | Reserved.   | 0x0   | R      |
|            |           | [2:0] | ECNT_TCH0 |          | Terminal count hold enable of error counters for Lane 0. When set, the designated counter is to hold the terminal count value of 0xFF when it is reached until the counter is reset by the user. Otherwise, the designated counter rolls over. Counters of each lane are addressed as follows:<br>Bit 2 = unexpected K (UEK) character error.<br>Bit 1 = not in table error (NIT).<br>Bit 0 = bad disparity error (BDE).<br>This signal must only be programmed while the QBD is held in soft reset (Register 0x475, Bit 3), and must not be changed during normal operation. | 0x7   | R/W    |
| 0x489      | ECNT_TCH1 | [7:3] | RESERVED  |          | Reserved.   | 0x0   | R      |
|            |           | [2:0] | ECNT_TCH1 |          | Terminal count hold enable of error counters for Lane 1. When set, the designated counter is to hold the terminal count value of 0xFF when it is reached until the counter is reset by the user. Otherwise, the designated counter rolls over. Counters of each lane are addressed as follows:<br>Bit 2 = unexpected K (UEK) character error.<br>Bit 1 = not in table error (NIT).<br>Bit 0 = bad disparity error (BDE).<br>This signal must only be programmed while the QBD is held in soft reset (Register 0x475, Bit 3), and must not be changed during normal operation. | 0x7   | R/W    |
| 0x48A      | ECNT_TCH2 | [7:3] | RESERVED  |          | Reserved.   | 0x0   | R      |
|            |           | [2:0] | ECNT_TCH2 |          | Terminal count hold enable of error counters for Lane 2. When set, the designated counter is to hold the terminal count value of 0xFF when it is reached until the counter is reset by the user. Otherwise, the designated counter rolls over. Counters of each lane are addressed as follows:<br>Bit 2 = unexpected K (UEK) character error.<br>Bit 1 = not in table error (NIT).<br>Bit 0 = bad disparity error (BDE).  | 0x7   | R/W    |

| Hex. Addr. | Name      | Bits  | Bit Name  | Settings | Description   | Reset | Access |
|------------|-----------|-------|-----------|----------|---|-------|--------|
|            |           |       |           |          | This signal must only be programmed while the QBD is held in soft reset (Register 0x475, Bit 3), and must not be changed during normal operation.   |       |        |
| 0x48B      | ECNT_TCH3 | [7:3] | RESERVED  |          | Reserved.   | 0x0   | R      |
|            |           | [2:0] | ECNT_TCH3 |          | Terminal count hold enable of error counters for Lane 3. When set, the designated counter is to hold the terminal count value of 0xFF when it is reached until the counter is reset by the user. Otherwise, the designated counter rolls over. Counters of each lane are addressed as follows:<br>Bit 2 = unexpected K (UEK) character error.<br>Bit 1 = not in table error (NIT).<br>Bit 0 = bad disparity error (BDE).<br>This signal must only be programmed while the QBD is held in soft reset (Register 0x475, Bit 3), and must not be changed during normal operation. | 0x7   | R/W    |
| 0x48C      | ECNT_TCH4 | [7:3] | RESERVED  |          | Reserved.   | 0x0   | R      |
|            |           | [2:0] | ECNT_TCH4 |          | Terminal count hold enable of error counters for Lane 4. When set, the designated counter is to hold the terminal count value of 0xFF when it is reached until the counter is reset by the user. Otherwise, the designated counter rolls over. Counters of each lane are addressed as follows:<br>Bit 2 = unexpected K (UEK) character error.<br>Bit 1 = not in table error (NIT).<br>Bit 0 = bad disparity error (BDE).<br>This signal must only be programmed while the QBD is held in soft reset (Register 0x475, Bit 3), and must not be changed during normal operation. | 0x7   | R/W    |
| 0x48D      | ECNT_TCH5 | [7:3] | RESERVED  |          | Reserved.   | 0x0   | R      |
|            |           | [2:0] | ECNT_TCH5 |          | Terminal count hold enable of error counters for Lane 5. When set, the designated counter is to hold the terminal count value of 0xFF when it is reached until the counter is reset by the user. Otherwise, the designated counter rolls over. Counters of each lane are addressed as follows:<br>Bit 2 = unexpected K (UEK) character error.<br>Bit 1 = not in table error (NIT).<br>Bit 0 = bad disparity error (BDE).  | 0x7   | R/W    |

| Hex. Addr. | Name       | Bits  | Bit Name  | Settings | Description   | Reset | Access |
|------------|------------|-------|-----------|----------|---|-------|--------|
|            |            |       |           |          | This signal must only be programmed while the QBD is held in soft reset (Register 0x475, Bit 3), and must not be changed during normal operation.   |       |        |
| 0x48E      | ECNT_TCH6  | [7:3] | RESERVED  |          | Reserved.   | 0x0   | R      |
|            |            | [2:0] | ECNT_TCH6 |          | Terminal count hold enable of error counters for Lane 6. When set, the designated counter is to hold the terminal count value of 0xFF when it is reached until the counter is reset by the user. Otherwise, the designated counter rolls over. Counters of each lane are addressed as follows:<br>Bit 2 = unexpected K (UEK) character error.<br>Bit 1 = not in table error (NIT).<br>Bit 0 = bad disparity error (BDE).<br>This signal must only be programmed while the QBD is held in soft reset (Register 0x475, Bit 3), and must not be changed during normal operation. | 0x7   | R/W    |
| 0x48F      | ECNT_TCH7  | [7:3] | RESERVED  |          | Reserved.   | 0x0   | R      |
|            |            | [2:0] | ECNT_TCH7 |          | Terminal count hold enable of error counters for Lane 7. When set, the designated counter is to hold the terminal count value of 0xFF when it is reached until the counter is reset by the user. Otherwise, the designated counter rolls over. Counters of each lane are addressed as follows:<br>Bit 2 = unexpected K (UEK) character error.<br>Bit 1 = not in table error (NIT).<br>Bit 0 = bad disparity error (BDE).<br>This signal must only be programmed while the QBD is held in soft reset (Register 0x475, Bit 3), and must not be changed during normal operation. | 0x7   | R/W    |
| 0x490      | ECNT_STAT0 | [7:4] | RESERVED  |          | Reserved.   | 0x0   | R      |
|            |            | 3     | LANE_ENA0 |          | This output indicates if lane0 is enabled.<br>0 Lane0 is held in soft reset.<br>1 Lane0 is enabled.   | 0x0   | R      |
|            |            | [2:0] | ECNT_TCRO |          | Terminal count reached indicator of error counters for Lane 0. Set to 1 when the corresponding counter terminal count value of 0xFF has been reached. Counters of each lane are addressed as follows.<br>Bit 2 = unexpected K (UEK) character error.<br>Bit 1 = not in table error (NIT).<br>Bit 0 = bad disparity error (BDE).   | 0x0   | R      |

| Hex. Addr. | Name       | Bits  | Bit Name  | Settings | Description   | Reset | Access |
|------------|------------|-------|-----------|----------|---|-------|--------|
| 0x491      | ECNT_STAT1 | [7:4] | RESERVED  |          | Reserved.   | 0x0   | R      |
|            |            | 3     | LANE_ENA1 |          | This output indicates if Lane 1 is enabled.<br>0 Lane 1 is held in soft reset.<br>1 Lane 1 is enabled.  | 0x0   | R      |
|            |            | [2:0] | ECNT_TCR1 |          | Terminal count reached indicator of error counters for Lane 1. Set to 1 when the corresponding counter terminal count value of 0xFF has been reached. Counters of each lane are addressed as follows.<br>Bit 2 = unexpected K (UEK) character error.<br>Bit 1 = not in table error (NIT).<br>Bit 0 = bad disparity error (BDE). | 0x0   | R      |
| 0x492      | ECNT_STAT2 | [7:4] | RESERVED  |          | Reserved.   | 0x0   | R      |
|            |            | 3     | LANE_ENA2 |          | This output indicates if Lane 2 is enabled.<br>0 Lane 2 is held in soft reset.<br>1 Lane 2 is enabled.  | 0x0   | R      |
|            |            | [2:0] | ECNT_TCR2 |          | Terminal count reached indicator of error counters for Lane 2. Set to 1 when the corresponding counter terminal count value of 0xFF has been reached. Counters of each lane are addressed as follows.<br>Bit 2 = unexpected K (UEK) character error.<br>Bit 1 = not in table error (NIT).<br>Bit 0 = bad disparity error (BDE). | 0x0   | R      |
| 0x493      | ECNT_STAT3 | [7:4] | RESERVED  |          | Reserved.   | 0x0   | R      |
|            |            | 3     | LANE_ENA3 |          | This output indicates if Lane 3 is enabled.<br>0 Lane 3 is held in soft reset.<br>1 Lane 3 is enabled.  | 0x0   | R      |
|            |            | [2:0] | ECNT_TCR3 |          | Terminal count reached indicator of error counters for Lane 3. Set to 1 when the corresponding counter terminal count value of 0xFF has been reached. Counters of each lane are addressed as follows:<br>Bit 2 = unexpected K (UEK) character error.<br>Bit 1 = not in table error (NIT).<br>Bit 0 = bad disparity error (BDE). | 0x0   | R      |
| 0x494      | ECNT_STAT4 | [7:4] | RESERVED  |          | Reserved.   | 0x0   | R      |
|            |            | 3     | LANE_ENA4 |          | This output indicates if Lane 4 is enabled.<br>0 Lane 4 is held in soft reset.<br>1 Lane 4 is enabled.  | 0x0   | R      |
|            |            | [2:0] | ECNT_TCR4 |          | Terminal count reached indicator of error counters for Lane 4. Set to 1 when the corresponding counter terminal count value of 0xFF has been reached. Counters of each lane are addressed as follows:   | 0x0   | R      |

| Hex. Addr. | Name       | Bits  | Bit Name  | Settings | Description   | Reset | Access |
|------------|------------|-------|-----------|----------|---|-------|--------|
|            |            |       |           |          | Bit 2 = unexpected K (UEK) character error.<br>Bit 1 = not in table error (NIT).<br>Bit 0 = bad disparity error (BDE).  |       |        |
| 0x495      | ECNT_STAT5 | [7:4] | RESERVED  |          | Reserved.   | 0x0   | R      |
|            |            | 3     | LANE_ENA5 |          | This output indicates if Lane 5 is enabled.<br><br>0 Lane 5 is held in soft reset.<br>1 Lane 5 is enabled.  | 0x0   | R      |
|            |            | [2:0] | ECNT_TCR5 |          | Terminal count reached indicator of error counters for Lane 5. Set to 1 when the corresponding counter terminal count value of 0xFF has been reached. Counters of each lane are addressed as follows:<br>Bit 2 = unexpected K (UEK) character error.<br>Bit 1 = not in table error (NIT).<br>Bit 0 = bad disparity error (BDE). | 0x0   | R      |
| 0x496      | ECNT_STAT6 | [7:4] | RESERVED  |          | Reserved.   | 0x0   | R      |
|            |            | 3     | LANE_ENA6 |          | This output indicates if Lane 6 is enabled.<br><br>0 Lane 6 is held in soft reset.<br>1 Lane 6 is enabled.  | 0x0   | R      |
|            |            | [2:0] | ECNT_TCR6 |          | Terminal count reached indicator of error counters for Lane 6. Set to 1 when the corresponding counter terminal count value of 0xFF has been reached. Counters of each lane are addressed as follows:<br>Bit 2 = unexpected K (UEK) character error.<br>Bit 1 = not in table error (NIT).<br>Bit 0 = bad disparity error (BDE). | 0x0   | R      |
| 0x497      | ECNT_STAT7 | [7:4] | RESERVED  |          | Reserved.   | 0x0   | R      |
|            |            | 3     | LANE_ENA7 |          | This output indicates if Lane 7 is enabled.<br><br>0 Lane 7 is held in soft reset.<br>1 Lane 7 is enabled.  | 0x0   | R      |
|            |            | [2:0] | ECNT_TCR7 |          | Terminal count reached indicator of error counters for Lane 7. Set to 1 when the corresponding counter terminal count value of 0xFF has been reached. Counters of each lane are addressed as follows:<br>Bit 2 = unexpected K (UEK) character error.<br>Bit 1 = not in table error (NIT).<br>Bit 0 = bad disparity error (BDE). | 0x0   | R      |
| 0x498      | BD_CNT0    | [7:0] | BD_CNT0   |          | Bad disparity 8-bit error counters for Lane 0.  | 0x0   | R      |
| 0x499      | BD_CNT1    | [7:0] | BD_CNT1   |          | Bad disparity 8-bit error counters for Lane 1.  | 0x0   | R      |
| 0x49A      | BD_CNT2    | [7:0] | BD_CNT2   |          | Bad disparity 8-bit error counters for Lane 2.  | 0x0   | R      |
| 0x49B      | BD_CNT3    | [7:0] | BD_CNT3   |          | Bad disparity 8-bit error counters for Lane 3.  | 0x0   | R      |

| Hex. Addr. | Name         | Bits  | Bit Name | Settings | Description  | Reset | Access |
|------------|--------------|-------|----------|----------|--|-------|--------|
| 0x49C      | BD_CNT4      | [7:0] | BD_CNT4  |          | Bad disparity 8-bit error counters for Lane 4.   | 0x0   | R      |
| 0x49D      | BD_CNT5      | [7:0] | BD_CNT5  |          | Bad disparity 8-bit error counters for Lane 5.   | 0x0   | R      |
| 0x49E      | BD_CNT6      | [7:0] | BD_CNT6  |          | Bad disparity 8-bit error counters for Lane 6.   | 0x0   | R      |
| 0x49F      | BD_CNT7      | [7:0] | BD_CNT7  |          | Bad disparity 8-bit error counters for Lane 7.   | 0x0   | R      |
| 0x4A0      | NIT_CNT0     | [7:0] | NIT_CNT0 |          | Not in table 8-bit error counters for Lane 0.  | 0x0   | R      |
| 0x4A1      | NIT_CNT1     | [7:0] | NIT_CNT1 |          | Not in table 8-bit error counters for Lane 1.  | 0x0   | R      |
| 0x4A2      | NIT_CNT2     | [7:0] | NIT_CNT2 |          | Not in table 8-bit error counters for Lane 2.  | 0x0   | R      |
| 0x4A3      | NIT_CNT3     | [7:0] | NIT_CNT3 |          | Not in table 8-bit error counters for Lane 3.  | 0x0   | R      |
| 0x4A4      | NIT_CNT4     | [7:0] | NIT_CNT4 |          | Not in table 8-bit error counters for Lane 4.  | 0x0   | R      |
| 0x4A5      | NIT_CNT5     | [7:0] | NIT_CNT5 |          | Not in table 8-bit error counters for Lane 5.  | 0x0   | R      |
| 0x4A6      | NIT_CNT6     | [7:0] | NIT_CNT6 |          | Not in table 8-bit error counters for Lane 6.  | 0x0   | R      |
| 0x4A7      | NIT_CNT7     | [7:0] | NIT_CNT7 |          | Not in table 8-bit error counters for Lane 7.  | 0x0   | R      |
| 0x4A8      | UEK_CNT0     | [7:0] | UEK_CNT0 |          | Unexpected K character 8-bit error counters for Lane 0.  | 0x0   | R      |
| 0x4A9      | UEK_CNT1     | [7:0] | UEK_CNT1 |          | Unexpected K character 8-bit error counters for Lane 1.  | 0x0   | R      |
| 0x4AA      | UEK_CNT2     | [7:0] | UEK_CNT2 |          | Unexpected K character 8-bit error counters for Lane 2.  | 0x0   | R      |
| 0x4AB      | UEK_CNT3     | [7:0] | UEK_CNT3 |          | Unexpected K character 8-bit error counters for Lane 3.  | 0x0   | R      |
| 0x4AC      | UEK_CNT4     | [7:0] | UEK_CNT4 |          | Unexpected K character 8-bit error counters for Lane 4.  | 0x0   | R      |
| 0x4AD      | UEK_CNT5     | [7:0] | UEK_CNT5 |          | Unexpected K character 8-bit error counters for Lane 5.  | 0x0   | R      |
| 0x4AE      | UEK_CNT6     | [7:0] | UEK_CNT6 |          | Unexpected K character 8-bit error counters for Lane 6.  | 0x0   | R      |
| 0x4AF      | UEK_CNT7     | [7:0] | UEK_CNT7 |          | Unexpected K character 8-bit error counters for Lane 7.  | 0x0   | R      |
| 0x4B0      | LINK_STATUS0 | 7     | BDE0     |          | Bad disparity errors status for Lane 0.<br>0 Error count < ETH[7:0] value.<br>1 Error count ≥ ETH[7:0] value.          | 0x0   | R      |
|            |              | 6     | NIT0     |          | Not in table errors status for Lane 0.<br>0 Error count < ETH[7:0] value.<br>1 Error count ≥ ETH[7:0] value.           | 0x0   | R      |
|            |              | 5     | UEK0     |          | Unexpected K character errors status for Lane 0.<br>0 Error count < ETH[7:0] value.<br>1 Error count ≥ ETH[7:0] value. | 0x0   | R      |
|            |              | 4     | ILD0     |          | Interlane deskew status for Lane 0 (ignore this output when NO_ILAS = 1).<br>0 Deskew failed.<br>1 Deskew achieved.    | 0x0   | R      |



| Hex. Addr. | Name         | Bits | Bit Name | Settings | Description   | Reset | Access |
|------------|--------------|------|----------|----------|---|-------|--------|
|            |              | 3    | ILS0     |          | Initial lane synchronization status for Lane 0 (ignore this output when NO_ILAS = 1).<br>0 Synchronization lost.<br>1 Synchronization achieved. | 0x0   | R      |
|            |              | 2    | CKS0     |          | Computed checksum status for Lane 0 (ignore this output when NO_ILAS = 1).<br>0 Checksum is incorrect.<br>1 Checksum is correct.                | 0x0   | R      |
|            |              | 1    | FS0      |          | Frame sync status for Lane 0 (ignore this output when NO_ILAS = 1).<br>0 Synchronization lost.<br>1 Synchronization achieved.                   | 0x0   | R      |
|            |              | 0    | CGS0     |          | Code group sync status for Lane 0.<br>0 Synchronization lost.<br>1 Synchronization achieved.  | 0x0   | R      |
| 0x4B1      | LINK_STATUS1 | 7    | BDE1     |          | Bad Disparity errors status for Lane 1.<br>0 Error count < ETH[7:0] value.<br>1 Error count ≥ ETH[7:0] value.                                   | 0x0   | R      |
|            |              | 6    | NIT1     |          | Not in table errors status for Lane 1.<br>0 Error count < ETH[7:0] value.<br>1 Error count ≥ ETH[7:0] value.                                    | 0x0   | R      |
|            |              | 5    | UEK1     |          | Unexpected K character errors status for Lane 1.<br>0 Error count < ETH[7:0] value.<br>1 Error count ≥ ETH[7:0] value.                          | 0x0   | R      |
|            |              | 4    | ILD1     |          | Interlane deskew status for Lane 1 (ignore this output when NO_ILAS = 1).<br>0 Deskew failed.<br>1 Deskew achieved.                             | 0x0   | R      |
|            |              | 3    | ILS1     |          | Initial lane synchronization status for Lane 1 (ignore this output when NO_ILAS = 1).<br>0 Synchronization lost.<br>1 Synchronization achieved. | 0x0   | R      |
|            |              | 2    | CKS1     |          | Computed checksum status for Lane 1 (ignore this output when NO_ILAS = 1).<br>0 Checksum is incorrect.<br>1 Checksum is correct.                | 0x0   | R      |
|            |              | 1    | FS1      |          | Frame sync status for Lane 1 (ignore this output when NO_ILAS = 1).<br>0 Synchronization lost.<br>1 Synchronization achieved.                   | 0x0   | R      |
|            |              | 0    | CGS1     |          | Code group sync status for Lane 1.<br>0 Synchronization lost.<br>1 Synchronization achieved.  | 0x0   | R      |

| Hex. Addr. | Name         | Bits | Bit Name | Settings | Description   | Reset | Access |
|------------|--------------|------|----------|----------|---|-------|--------|
| 0x4B2      | LINK_STATUS2 | 7    | BDE2     |          | Bad Disparity errors status for Lane 2.<br>0 Error count < ETH[7:0] value.<br>1 Error count ≥ ETH[7:0] value.                                   | 0x0   | R      |
|            |              | 6    | NIT2     |          | Not in table errors status for Lane 2.<br>0 Error count < ETH[7:0] value.<br>1 Error count ≥ ETH[7:0] value.                                    | 0x0   | R      |
|            |              | 5    | UEK2     |          | Unexpected K character errors status for Lane 2.<br>0 Error count < ETH[7:0] value.<br>1 Error count ≥ ETH[7:0] value.                          | 0x0   | R      |
|            |              | 4    | ILD2     |          | Interlane deskew status for Lane 2 (ignore this output when NO_ILAS = 1).<br>0 Deskew failed.<br>1 Deskew achieved.                             | 0x0   | R      |
|            |              | 3    | ILS2     |          | Initial lane synchronization status for Lane 2 (ignore this output when NO_ILAS = 1).<br>0 Synchronization lost.<br>1 Synchronization achieved. | 0x0   | R      |
|            |              | 2    | CKS2     |          | Computed checksum status for Lane 2 (ignore this output when NO_ILAS = 1).<br>0 Checksum is incorrect.<br>1 Checksum is correct.                | 0x0   | R      |
|            |              | 1    | FS2      |          | Frame sync status for Lane 2 (ignore this output when NO_ILAS = 1).<br>0 Synchronization lost.<br>1 Synchronization achieved.                   | 0x0   | R      |
|            |              | 0    | CGS2     |          | Code group sync status for Lane 2.<br>0 Synchronization lost.<br>1 Synchronization achieved.  | 0x0   | R      |
| 0x4B3      | LINK_STATUS3 | 7    | BDE3     |          | Bad Disparity errors status for Lane 3.<br>0 Error count < ETH[7:0] value.<br>1 Error count ≥ ETH[7:0] value.                                   | 0x0   | R      |
|            |              | 6    | NIT3     |          | Not in table errors status for Lane 3.<br>0 Error count < ETH[7:0] value.<br>1 Error count ≥ ETH[7:0] value.                                    | 0x0   | R      |
|            |              | 5    | UEK3     |          | Unexpected K character errors status for Lane 3.<br>0 Error count < ETH[7:0] value.<br>1 Error count ≥ ETH[7:0] value.                          | 0x0   | R      |
|            |              | 4    | ILD3     |          | Interlane deskew status for Lane 3 (ignore this output when NO_ILAS = 1).<br>0 Deskew failed.<br>1 Deskew achieved.                             | 0x0   | R      |
|            |              | 3    | ILS3     |          | Initial lane synchronization status for Lane 3 (ignore this output when NO_ILAS = 1).<br>0 Synchronization lost.<br>1 Synchronization achieved. | 0x0   | R      |

| Hex. Addr. | Name         | Bits | Bit Name | Settings | Description   | Reset | Access |
|------------|--------------|------|----------|----------|---|-------|--------|
|            |              | 2    | CKS3     |          | Computed checksum status for Lane 3 (ignore this output when NO_ILAS = 1).<br>0 Checksum is incorrect.<br>1 Checksum is correct.                | 0x0   | R      |
|            |              | 1    | FS3      |          | Frame sync status for Lane 3 (ignore this output when NO_ILAS = 1).<br>0 Synchronization lost.<br>1 Synchronization achieved.                   | 0x0   | R      |
|            |              | 0    | CGS3     |          | Code group sync status for Lane 3.<br>0 Synchronization lost.<br>1 Synchronization achieved.  | 0x0   | R      |
| 0x4B4      | LINK_STATUS4 | 7    | BDE4     |          | Bad Disparity errors status for Lane 4.<br>0 Error count < ETH[7:0] value.<br>1 Error count ≥ ETH[7:0] value.                                   | 0x0   | R      |
|            |              | 6    | NIT4     |          | Not in table errors status for Lane 4.<br>0 Error count < ETH[7:0] value.<br>1 Error count ≥ ETH[7:0] value.                                    | 0x0   | R      |
|            |              | 5    | UEK4     |          | Unexpected K character errors status for Lane 4.<br>0 Error count < ETH[7:0] value.<br>1 Error count ≥ ETH[7:0] value.                          | 0x0   | R      |
|            |              | 4    | ILD4     |          | Interlane deskew status for Lane 4 (ignore this output when NO_ILAS = 1).<br>0 Deskew failed.<br>1 Deskew achieved.                             | 0x0   | R      |
|            |              | 3    | ILS4     |          | Initial lane synchronization status for Lane 4 (ignore this output when NO_ILAS = 1).<br>0 Synchronization lost.<br>1 Synchronization achieved. | 0x0   | R      |
|            |              | 2    | CKS4     |          | Computed checksum status for Lane 4 (ignore this output when NO_ILAS = 1).<br>0 Checksum is incorrect.<br>1 Checksum is correct.                | 0x0   | R      |
|            |              | 1    | FS4      |          | Frame sync status for Lane 4 (ignore this output when NO_ILAS = 1).<br>0 Synchronization lost.<br>1 Synchronization achieved.                   | 0x0   | R      |
|            |              | 0    | CGS4     |          | Code group sync status for Lane 4.<br>0 Synchronization lost.<br>1 Synchronization achieved.  | 0x0   | R      |
| 0x4B5      | LINK_STATUS5 | 7    | BDE5     |          | Bad disparity errors status for Lane 5.<br>0 Error count < ETH[7:0] value.<br>1 Error count ≥ ETH[7:0] value.                                   | 0x0   | R      |

| Hex. Addr. | Name         | Bits | Bit Name | Settings | Description   | Reset | Access |
|------------|--------------|------|----------|----------|---|-------|--------|
|            |              | 6    | NIT5     |          | Not in table errors status for Lane 5.<br>0 Error count < ETH[7:0] value.<br>1 Error count ≥ ETH[7:0] value.                                    | 0x0   | R      |
|            |              | 5    | UEK5     |          | Unexpected K character errors status for Lane 5.<br>0 Error count < ETH[7:0] value.<br>1 Error count ≥ ETH[7:0] value.                          | 0x0   | R      |
|            |              | 4    | ILD5     |          | Interlane deskew status for Lane 5 (ignore this output when NO_ILAS = 1).<br>0 Deskew failed.<br>1 Deskew achieved.                             | 0x0   | R      |
|            |              | 3    | ILS5     |          | Initial lane synchronization status for Lane 5 (ignore this output when NO_ILAS = 1).<br>0 Synchronization lost.<br>1 Synchronization achieved. | 0x0   | R      |
|            |              | 2    | CKS5     |          | Computed checksum status for Lane 5 (ignore this output when NO_ILAS = 1).<br>0 Checksum is incorrect.<br>1 Checksum is correct.                | 0x0   | R      |
|            |              | 1    | FSS      |          | Frame sync status for Lane 5 (ignore this output when NO_ILAS = 1).<br>0 Synchronization lost.<br>1 Synchronization achieved.                   | 0x0   | R      |
|            |              | 0    | CGS5     |          | Code group sync status for Lane 5.<br>0 Synchronization lost.<br>1 Synchronization achieved.  | 0x0   | R      |
| 0x4B6      | LINK_STATUS6 | 7    | BDE6     |          | Bad Disparity errors status for Lane 6.<br>0 Error count < ETH[7:0] value.<br>1 Error count ≥ ETH[7:0] value.                                   | 0x0   | R      |
|            |              | 6    | NIT6     |          | Not in table errors status for Lane 6.<br>0 Error count < ETH[7:0] value.<br>1 Error count ≥ ETH[7:0] value.                                    | 0x0   | R      |
|            |              | 5    | UEK6     |          | Unexpected K character errors status for Lane 6.<br>0 Error count < ETH[7:0] value.<br>1 Error count ≥ ETH[7:0] value.                          | 0x0   | R      |
|            |              | 4    | ILD6     |          | Interlane deskew status for Lane 6 (ignore this output when NO_ILAS = 1).<br>0 Deskew failed.<br>1 Deskew achieved.                             | 0x0   | R      |
|            |              | 3    | ILS6     |          | Initial lane synchronization status for Lane 6 (ignore this output when NO_ILAS = 1).<br>0 Synchronization lost.<br>1 Synchronization achieved. | 0x0   | R      |

| Hex. Addr. | Name             | Bits | Bit Name | Settings | Description   | Reset | Access |
|------------|------------------|------|----------|----------|---|-------|--------|
|            |                  | 2    | CKS6     |          | Computed checksum status for Lane 6 (ignore this output when NO_ILAS = 1).<br>0 Checksum is incorrect.<br>1 Checksum is correct.                | 0x0   | R      |
|            |                  | 1    | FS6      |          | Frame sync status for Lane 6 (ignore this output when NO_ILAS = 1).<br>0 Synchronization lost.<br>1 Synchronization achieved.                   | 0x0   | R      |
|            |                  | 0    | CGS6     |          | Code group sync status for Lane 6.<br>0 Synchronization lost.<br>1 Synchronization achieved.  | 0x0   | R      |
| 0x4B7      | LINK_STATUS7     | 7    | BDE7     |          | Bad Disparity errors status for Lane 7.<br>0 Error count < ETH[7:0] value.<br>1 Error count ≥ ETH[7:0] value.                                   | 0x0   | R      |
|            |                  | 6    | NIT7     |          | Not in table errors status for Lane 7.<br>0 Error count < ETH[7:0] value.<br>1 Error count ≥ ETH[7:0] value.                                    | 0x0   | R      |
|            |                  | 5    | UEK7     |          | Unexpected K character errors status for Lane 7<br>0 Error count < ETH[7:0] value.<br>1 Error count ≥ ETH[7:0] value.                           | 0x0   | R      |
|            |                  | 4    | ILD7     |          | Interlane deskew status for Lane 7 (ignore this output when NO_ILAS = 1).<br>0 Deskew failed.<br>1 Deskew achieved.                             | 0x0   | R      |
|            |                  | 3    | ILS7     |          | Initial lane synchronization status for Lane 7 (ignore this output when NO_ILAS = 1).<br>0 Synchronization lost.<br>1 Synchronization achieved. | 0x0   | R      |
|            |                  | 2    | CKS7     |          | Computed checksum status for Lane 7 (ignore this output when NO_ILAS = 1).<br>0 Checksum is incorrect.<br>1 Checksum is correct.                | 0x0   | R      |
|            |                  | 1    | FS7      |          | Frame sync status for Lane 7 (ignore this output when NO_ILAS = 1).<br>0 Synchronization lost.<br>1 Synchronization achieved.                   | 0x0   | R      |
|            |                  | 0    | CGS7     |          | Code group sync status for Lane 7.<br>0 Synchronization lost.<br>1 Synchronization achieved.  | 0x0   | R      |
| 0x4B8      | JESD_IRQ_ENABLEA | 7    | EN_BDE   |          | Bad disparity error counter.  | 0x0   | R/W    |
|            |                  | 6    | EN_NIT   |          | Not in table error counter.   | 0x0   | R/W    |
|            |                  | 5    | EN_UEK   |          | Unexpected K error counter.   | 0x0   | R/W    |
|            |                  | 4    | EN_ILD   |          | Interlane deskew.   | 0x0   | R/W    |
|            |                  | 3    | EN_ILS   |          | Initial lane sync.  | 0x0   | R/W    |

| Hex. Addr. | Name             | Bits  | Bit Name  | Settings | Description   | Reset | Access |
|------------|------------------|-------|-----------|----------|---|-------|--------|
|            |                  | 2     | EN_CKS    |          | Good checksum. This is an interrupt that compares two checksums: the checksum that the transmitter sent over the link during the ILAS, and the checksum that the receiver calculated from the ILAS data that the transmitter sent over the link. Note that the checksum IRQ never at any time looks at the checksum that is programmed over the SPI into Register 0x45D. The checksum IRQ only looks at the data sent by the transmitter, and never looks at any data programmed via the SPI. | 0x0   | R/W    |
|            |                  | 1     | EN_FS     |          | Frame sync.   | 0x0   | R/W    |
|            |                  | 0     | EN_CGS    |          | Code group sync.  | 0x0   | R/W    |
| 0x4B9      | JESD_IRQ_ENABLEB | [7:1] | RESERVED  |          | Reserved.   | 0x0   | R      |
|            |                  | 0     | EN_ILAS   |          | Configuration mismatch (checked for Lane 0 only). The ILAS IRQ compares the two sets of ILAS data that the receiver has: the ILAS data sent over the JESD204B link by the transmitter, and the ILAS data programmed into the receiver via the SPI (Register 0x450 to Register 0x45D). If the data differs, the IRQ is triggered. Note that all of the ILAS data (including the checksum) is compared.   | 0x0   | R/W    |
| 0x4BA      | JESD_IRQ_STATUSA | 7     | IRQ_BDE   |          | Bad disparity error counter.  | 0x0   | R/W    |
|            |                  | 6     | IRQ_NIT   |          | Not in table error counter.   | 0x0   | R/W    |
|            |                  | 5     | IRQ_UEK   |          | Unexpected K error counter.   | 0x0   | R/W    |
|            |                  | 4     | IRQ_ILD   |          | Interlane deskew.   | 0x0   | R/W    |
|            |                  | 3     | IRQ_ILS   |          | Initial lane sync.  | 0x0   | R/W    |
|            |                  | 2     | IRQ_CKS   |          | Good checksum.  | 0x0   | R/W    |
|            |                  | 1     | IRQ_FS    |          | Frame sync.   | 0x0   | R/W    |
|            |                  | 0     | IRQ_CGS   |          | Code group sync.  | 0x0   | R/W    |
| 0x4BB      | JESD_IRQ_STATUSB | [7:1] | RESERVED  |          | Reserved.   | 0x0   | R      |
|            |                  | 0     | IRQ_ILAS  |          | Configuration mismatch (checked for Lane 0 only).   | 0x0   | R/W    |
| 0x800      | HOPF_CTRL        | [7:6] | HOPF_MODE | 00       | Frequency switch mode.  | 0x0   | R/W    |
|            |                  |       |           | 01       | Phase discontinuous switch. Changes the frequency tuning word and resets the phase accumulator.   |       |        |
|            |                  |       |           | 10       | Reserved.   |       |        |
|            |                  | [5:0] | RESERVED  |          | Reserved.   | 0x0   | R      |

OUTLINE DIMENSIONS

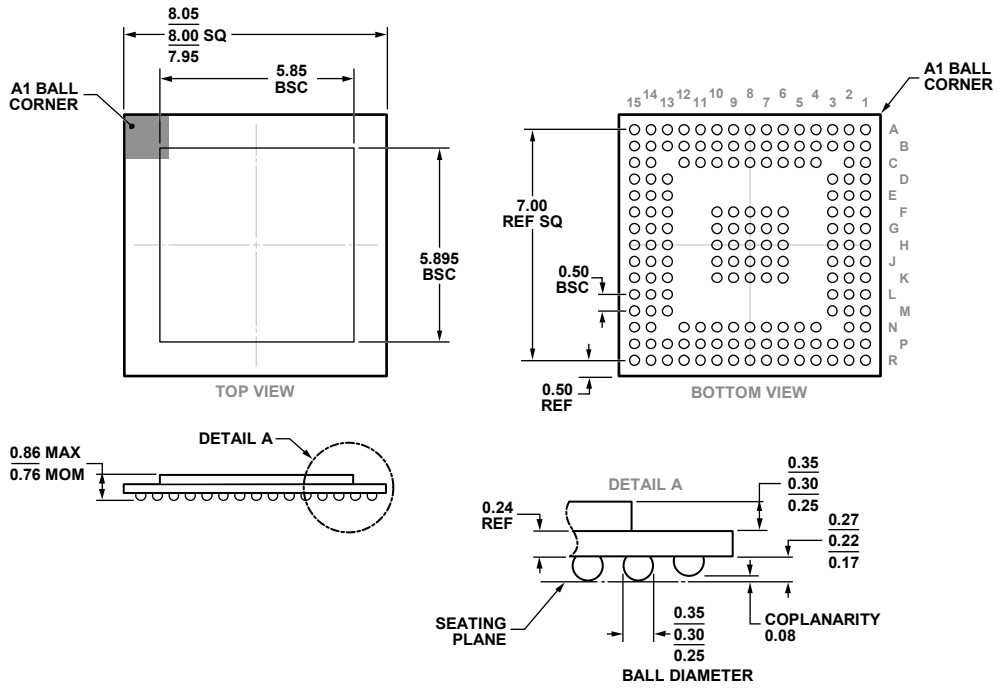
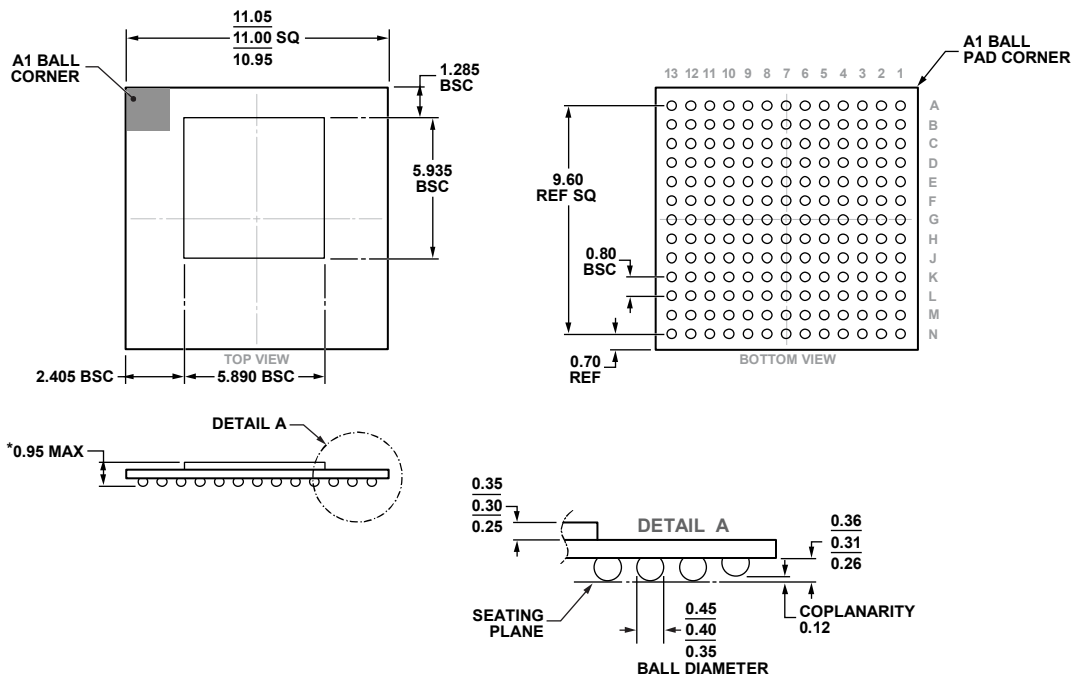

Figure 195. 165-Ball Chip Scale Package Ball Grid Array [CSP\_BGA] (BC-165-1)  
Dimensions shown in millimeters



\*COMPLIANT TO JEDEC STANDARDS MO-275-FFAC-1 WITH THE EXCEPTION OF PACKAGE HEIGHT AND THICKNESS.

Figure 196. 169-Ball Chip Scale Package Ball Grid Array [CSP\_BGA] (BC-169-2)  
Dimensions shown in millimeters

## ORDERING GUIDE

| Model <sup>1</sup> | Temperature Range | Package Description  | Package Option |
|--------------------|-------------------|--|----------------|
| AD9161BBCZ         | -40°C to +85°C    | 169-Ball Chip Scale Package Ball Grid Array [CSP_BGA]  | BC-169-2       |
| AD9161BBCZRL       | -40°C to +85°C    | 169-Ball Chip Scale Package Ball Grid Array [CSP_BGA]  | BC-169-2       |
| AD9162BBCZ         | -40°C to +85°C    | 165-Ball Chip Scale Package Ball Grid Array [CSP_BGA]  | BC-165-1       |
| AD9162BBCZRL       | -40°C to +85°C    | 165-Ball Chip Scale Package Ball Grid Array [CSP_BGA]  | BC-165-1       |
| AD9162BBCAZ        | -40°C to +85°C    | 169-Ball Chip Scale Package Ball Grid Array [CSP_BGA]  | BC-169-2       |
| AD9162BBCAZRL      | -40°C to +85°C    | 169-Ball Chip Scale Package Ball Grid Array [CSP_BGA]  | BC-169-2       |
| AD9162BBCA         | -40°C to +85°C    | 169-Ball Chip Scale Package Ball Grid Array [CSP_BGA]  | BC-169-2       |
| AD9162BBCARL       | -40°C to +85°C    | 169-Ball Chip Scale Package Ball Grid Array [CSP_BGA]  | BC-169-2       |
| AD9161-FMCC-EBZ    |                   | Evaluation Board with Balun and Match Optimized for Wider Output Bandwidth                           |                |
| AD9162-FMC-EBZ     |                   | Evaluation Board for 8 mm × 8 mm Package with High Accuracy Balance Balun                            |                |
| AD9162-FMCB-EBZ    |                   | Evaluation Board for 8 mm × 8 mm Package with Balun and Match Optimized For Wider Output Bandwidth   |                |
| AD9162-FMCC-EBZ    |                   | Evaluation Board for 11 mm × 11 mm Package with Balun and Match Optimized for Wider Output Bandwidth |                |

<sup>1</sup> Z = RoHS Compliant Part.





Компания «ЭлектроПласт» предлагает заключение долгосрочных отношений при поставках импортных электронных компонентов на взаимовыгодных условиях!

Наши преимущества:

- Оперативные поставки широкого спектра электронных компонентов отечественного и импортного производства напрямую от производителей и с крупнейших мировых складов;
- Поставка более 17-ти миллионов наименований электронных компонентов;
- Поставка сложных, дефицитных, либо снятых с производства позиций;
- Оперативные сроки поставки под заказ (от 5 рабочих дней);
- Экспресс доставка в любую точку России;
- Техническая поддержка проекта, помощь в подборе аналогов, поставка прототипов;
- Система менеджмента качества сертифицирована по Международному стандарту ISO 9001;
- Лицензия ФСБ на осуществление работ с использованием сведений, составляющих государственную тайну;
- Поставка специализированных компонентов (Xilinx, Altera, Analog Devices, Intersil, Interpoint, Microsemi, Aeroflex, Peregrine, Syfer, Eurofarad, Texas Instrument, Miteq, Cobham, E2V, MA-COM, Hittite, Mini-Circuits, General Dynamics и др.);

Помимо этого, одним из направлений компании «ЭлектроПласт» является направление «Источники питания». Мы предлагаем Вам помощь Конструкторского отдела:

- Подбор оптимального решения, техническое обоснование при выборе компонента;
- Подбор аналогов;
- Консультации по применению компонента;
- Поставка образцов и прототипов;
- Техническая поддержка проекта;
- Защита от снятия компонента с производства.



#### Как с нами связаться

**Телефон:** 8 (812) 309 58 32 (многоканальный)

**Факс:** 8 (812) 320-02-42

**Электронная почта:** [org@eplast1.ru](mailto:org@eplast1.ru)

**Адрес:** 198099, г. Санкт-Петербург, ул. Калинина, дом 2, корпус 4, литера А.