

EE-SY671/672

Photomicrosensor with sensitivity adjuster.

- Easy adjustment with a built-in sensitivity adjuster.
- Easy optical axis monitoring with a bright light indicator.
- Compact design incorporating a built-in amplifier and special IC enables direct switching capacity of up to 100 mA.
- Wide operating voltage range: 5 to 24 VDC
- Connection possible with a range of ICs, relays, and Programmable Controllers (PLCs).

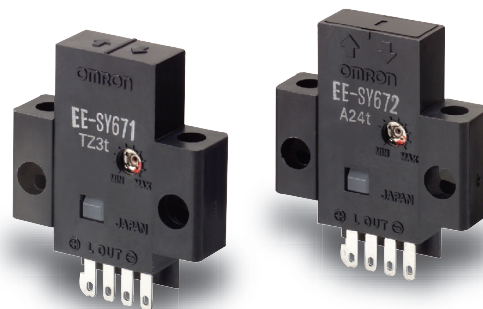



 Be sure to read *Safety Precautions* on page 4.

Ordering Information

Sensors

 Infrared light

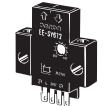
Appearance	Sensing method	Sensing distance	Output type	Output configuration	Model
Horizontal type 	Reflective type	 1 to 5 mm	NPN output	Dark-ON or Light-ON (Selectable) *	EE-SY671
Vertical type 					EE-SY672

* The Dark-ON/Light-ON (selectable) models are normally used as dark-ON models. To use them as light-ON models, short-circuit the L terminal and positive (+) terminal.
An EE-1001-1 Connector with the terminals already short-circuited is also available.

Accessories (Order Separately)

Type	Cable length	Model	Remarks
Connector		EE-1001	
		EE-1001-1	L terminal and positive (+) terminal are already short-circuited.
		EE-1009	
Connector with Cable	1 m	EE-1006	
		EE-1010	
	2 m	EE-1006	
		EE-1010	
Connector with Robot Cable	1 m	EE-1010-R	
	2 m	EE-1010-R	

* Refer to *Accessories* for details.

Ratings and Specifications

Item	Models	EE-SY671, EE-SY672
Sensing distance		1 to 5 mm (Reflection factor: 90%; white paper 15 × 15 mm)
Sensing object		Transparent or opaque: 15 × 15 mm min.
Differential distance		0.5 max. (with a sensing distance of 3 mm, horizontally)
Light source		GaAs infrared LED with a peak wavelength of 940 nm
Indicator *1		Light indicator (red)
Supply voltage		5 to 24 VDC ±10%, ripple (p-p): 10% max.
Current consumption		40 mA max.
Control output		NPN open collector: Load power supply voltage: 5 to 24 VDC Load current: 100 mA max. OFF current: 0.5 mA max. 100 mA load current with a residual voltage of 0.8 V max. 40 mA load current with a residual voltage of 0.4 V max.
Response frequency *2		50 Hz min. (Average: 500 Hz)
Ambient illumination *3		1,500 lx max. with fluorescent light on the surface of the receiver
Ambient temperature range		Operating: -25 to +55°C Storage: -30 to +80°C
Ambient humidity range		Operating: 5% to 85% Storage: 5% to 95%
Vibration resistance		Destruction: 20 to 2,000 Hz (peak acceleration: 100 m/s ²) 1.5-mm double amplitude for 2 h (4-min periods) each in X, Y, and Z directions
Shock resistance		Destruction: 500m/s ² for 3 times each in X, Y, and Z directions
Degree of protection		IEC IP50
Connecting method		Special connector (direct soldering possible)
Weight		Approx. 3.5 g (including screwdriver for adjustment)
Material	Case	Polybutylene phthalate (PBT)
	Emitter/receiver	Polycarbonate
Accessories		Screwdriver for adjustment

*1. The indicator is a GaP red LED (peak wavelength: 690 nm).

*2. The response frequency was measured by detecting the following rotating disk.

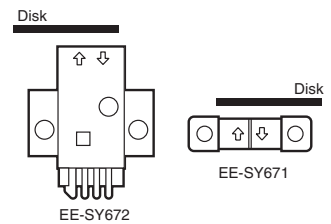
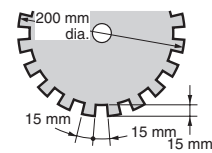

*3. The ambient illuminance is measured on the surface of the receiver.

Engineering Data (Typical)

Operating Range Characteristics (Max. Sensitivity)

EE-SY67□

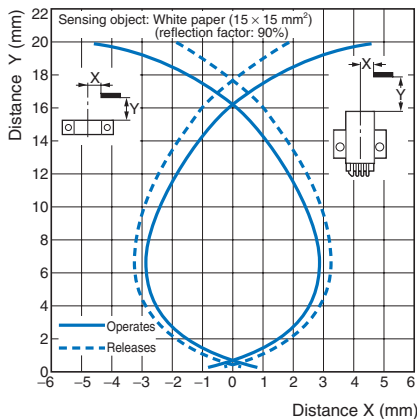

EE-SY67□

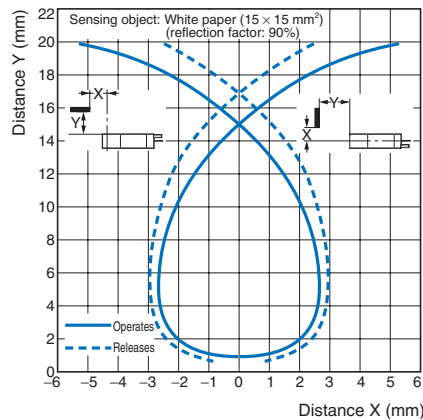

Sensing Distance vs. Object Area Characteristics

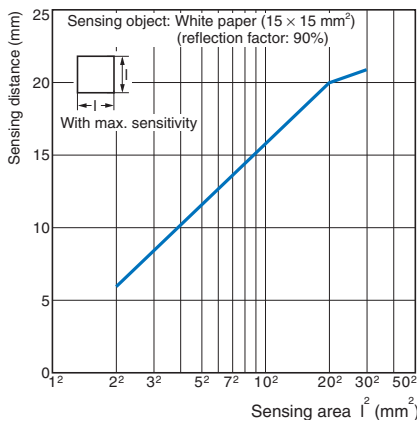

Sensing Distance vs. Sensitivity Volume

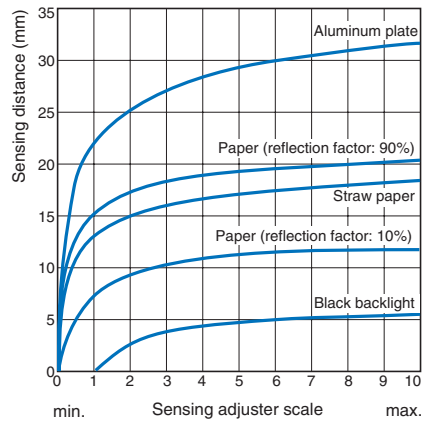

I/O Circuit Diagrams

NPN Output

Model	Output configuration	Timing charts	Terminal connections	Output circuit
EE-SY671 EE-SY672	Light-ON	Incident Interrupted Light indicator (red) ON OFF Output transistor ON OFF Load 1 (relay) Operates Releases	Short-circuited between ⓪ terminal and positive ⊕ terminal	
	Dark-ON	Incident Interrupted Light indicator (red) ON OFF Output transistor ON OFF Load 1 (relay) Operates Releases	Open between ⓪ terminal and positive ⊕ terminal	

Safety Precautions

Refer to *Warranty and Limitations of Liability*.

⚠ WARNING

This product is not designed or rated for ensuring safety of persons either directly or indirectly. Do not use it for such purposes.



Precautions for Correct Use

Make sure that this product is used within the rated ambient environment conditions.

● **Wiring**

Soldering

- When direct soldering to the terminal, use the following guidelines.

Soldering Conditions

Item	Temperature	Permissible time	Remarks
Soldering iron	350°C max.	3 s max.	The portion between the base of the terminals and the position 1.5 mm from the terminal base must not be soldered.

- The terminal base uses a polycarbonate resin, which could be deformed by excessive soldering heat, resulting in damage to the product's functionality.

Cable Extension

- When extending the cable, use an extension cable with conductors having a total cross-section area of 0.3 mm². The total cable length must be less than 10 m.

● **Installation**

The photomicrosensor is built into the device being used and so is not equipped to deal with interference from an external light source. When using the sensor in an area exposed to an incandescent lamp, install so as to minimize the effects of external light sources.

● **Sensitivity Adjustment**

Use the special screwdriver (sold together) for sensitivity adjustment.

- When an excessive force is applied to sensitivity adjuster, it may be damaged.
- The shaft of the sensitivity adjuster is charged. Connect a DC power supply incorporating an insulated transformer to the photomicrosensor. Do not connect a DC power supply incorporating an autotransformer or the user may receive an electric shock when adjusting the sensitivity.

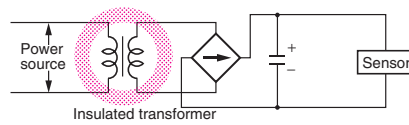
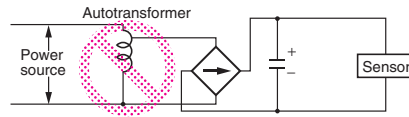

Sensitivity Adjustment with Background Object

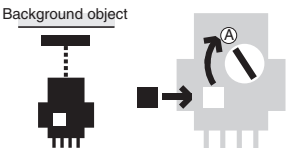
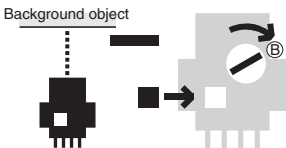
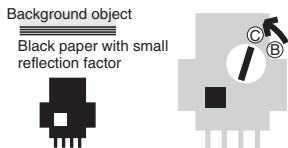
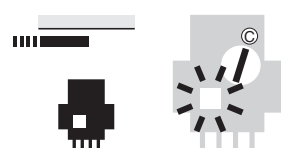
		Point A	Point B	Setting	Check
Sensing conditions	Adjuster indicator				
		<p>1. Set the sensitivity of the photomicrosensor to minimum, place the sensing object in the sensing position, turn the sensitivity adjuster clockwise slowly until the light indicator is lit (point A).</p>	<p>2. Remove the sensing object, at which time the light indicator will be OFF. Further turn the sensitivity adjuster clockwise slowly until the light indicator is lit again (point B). The operation indicator will not light again if the background object does not reflect light, in which case refer to "Sensitivity Adjustment with No Background Object".</p>	<p>3. Set the sensitivity adjuster at the center (point C) between point A and B. Points A and B will be very close if the sensor is influenced by excessive light reflected by the background object, in which case take the following preventive measures.</p> <ul style="list-style-type: none"> (1) Separate the sensor and the background object by a distance of 20 mm min. (2) Cover the surface of the background object with a material with a small reflection factor, such as black sponge. 	<p>4. After setting the sensitivity adjuster to point C, check if the light indicator is lit on placing the sensing object at the sensing position and not lit on removing the sensing object.</p>

Sensitivity Adjustment with No Background Object

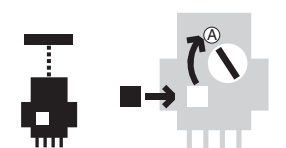
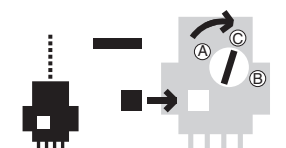
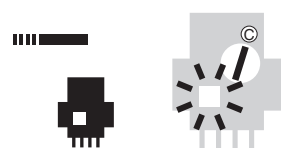
		Point A	Point B	Check
Sensing conditions	Adjuster indicator			
		<p>1. Set the sensitivity of the photomicrosensor to minimum, place the sensing object at the sensing position, turn the sensitivity adjuster clockwise slowly until the light indicator is lit (point A).</p>	<p>2. Set the sensitivity adjuster at the center (point C) between points A and B (the point where the sensitivity is maximum).</p>	<p>3. After setting the sensitivity adjuster to point C, check if the light indicator is not lit on removing the sensing object.</p>

Dimensions

Tolerance class IT16 applies to dimensions in this datasheet unless otherwise specified.

Sensors

EE-SY671

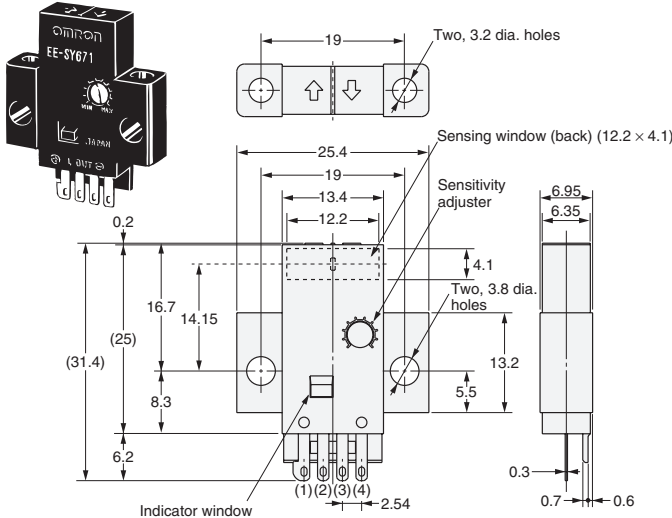

Terminal Arrangement

(1)	+	Vcc
(2)	L	L
(3)	OUT	OUTPUT
(4)	-	GND (0 V)

EE-SY672

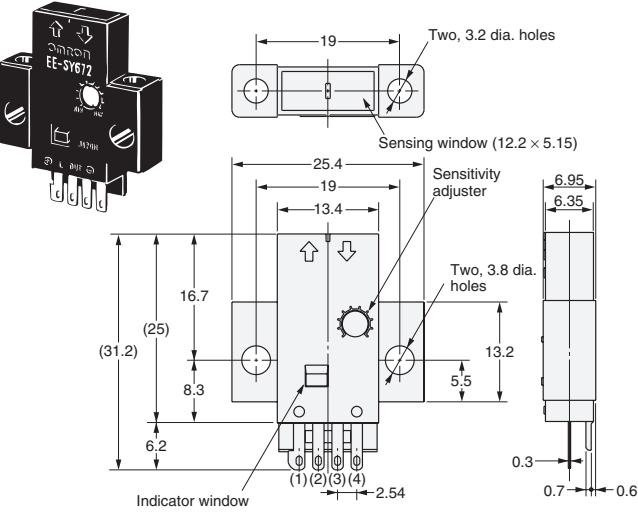

Terminal Arrangement

(1)	+	Vcc
(2)	L	L
(3)	OUT	OUTPUT
(4)	-	GND (0 V)

Accessories (Order Separately)

* Refer to Accessories for details.

Read and Understand This Catalog

Please read and understand this catalog before purchasing the products. Please consult your OMRON representative if you have any questions or comments.

Warranty and Limitations of Liability

WARRANTY

OMRON's exclusive warranty is that the products are free from defects in materials and workmanship for a period of one year (or other period if specified) from date of sale by OMRON.

OMRON MAKES NO WARRANTY OR REPRESENTATION, EXPRESS OR IMPLIED, REGARDING NON-INFRINGEMENT, MERCHANTABILITY, OR FITNESS FOR PARTICULAR PURPOSE OF THE PRODUCTS. ANY BUYER OR USER ACKNOWLEDGES THAT THE BUYER OR USER ALONE HAS DETERMINED THAT THE PRODUCTS WILL SUITABLY MEET THE REQUIREMENTS OF THEIR INTENDED USE. OMRON DISCLAIMS ALL OTHER WARRANTIES, EXPRESS OR IMPLIED.

LIMITATIONS OF LIABILITY

OMRON SHALL NOT BE RESPONSIBLE FOR SPECIAL, INDIRECT, OR CONSEQUENTIAL DAMAGES, LOSS OF PROFITS OR COMMERCIAL LOSS IN ANY WAY CONNECTED WITH THE PRODUCTS, WHETHER SUCH CLAIM IS BASED ON CONTRACT, WARRANTY, NEGLIGENCE, OR STRICT LIABILITY.

In no event shall the responsibility of OMRON for any act exceed the individual price of the product on which liability is asserted.

IN NO EVENT SHALL OMRON BE RESPONSIBLE FOR WARRANTY, REPAIR, OR OTHER CLAIMS REGARDING THE PRODUCTS UNLESS OMRON'S ANALYSIS CONFIRMS THAT THE PRODUCTS WERE PROPERLY HANDLED, STORED, INSTALLED, AND MAINTAINED AND NOT SUBJECT TO CONTAMINATION, ABUSE, MISUSE, OR INAPPROPRIATE MODIFICATION OR REPAIR.

Application Considerations

SUITABILITY FOR USE

OMRON shall not be responsible for conformity with any standards, codes, or regulations that apply to the combination of products in the customer's application or use of the products.

At the customer's request, OMRON will provide applicable third party certification documents identifying ratings and limitations of use that apply to the products. This information by itself is not sufficient for a complete determination of the suitability of the products in combination with the end product, machine, system, or other application or use.

The following are some examples of applications for which particular attention must be given. This is not intended to be an exhaustive list of all possible uses of the products, nor is it intended to imply that the uses listed may be suitable for the products:

- Outdoor use, uses involving potential chemical contamination or electrical interference, or conditions or uses not described in this catalog.
- Nuclear energy control systems, combustion systems, railroad systems, aviation systems, medical equipment, amusement machines, vehicles, safety equipment, and installations subject to separate industry or government regulations.
- Systems, machines, and equipment that could present a risk to life or property.

Please know and observe all prohibitions of use applicable to the products.

NEVER USE THE PRODUCTS FOR AN APPLICATION INVOLVING SERIOUS RISK TO LIFE OR PROPERTY WITHOUT ENSURING THAT THE SYSTEM AS A WHOLE HAS BEEN DESIGNED TO ADDRESS THE RISKS, AND THAT THE OMRON PRODUCTS ARE PROPERLY RATED AND INSTALLED FOR THE INTENDED USE WITHIN THE OVERALL EQUIPMENT OR SYSTEM.

PROGRAMMABLE PRODUCTS

OMRON shall not be responsible for the user's programming of a programmable product, or any consequence thereof.

Disclaimers

CHANGE IN SPECIFICATIONS

Product specifications and accessories may be changed at any time based on improvements and other reasons.

It is our practice to change model numbers when published ratings or features are changed, or when significant construction changes are made. However, some specifications of the products may be changed without any notice. When in doubt, special model numbers may be assigned to fix or establish key specifications for your application on your request. Please consult with your OMRON representative at any time to confirm actual specifications of purchased products.

DIMENSIONS AND WEIGHTS

Dimensions and weights are nominal and are not to be used for manufacturing purposes, even when tolerances are shown.

PERFORMANCE DATA

Performance data given in this catalog is provided as a guide for the user in determining suitability and does not constitute a warranty. It may represent the result of OMRON's test conditions, and the users must correlate it to actual application requirements. Actual performance is subject to the OMRON Warranty and Limitations of Liability.

ERRORS AND OMISSIONS

The information in this document has been carefully checked and is believed to be accurate; however, no responsibility is assumed for clerical, typographical, or proofreading errors, or omissions.

2008.11

In the interest of product improvement, specifications are subject to change without notice.

OMRON Corporation
Industrial Automation Company

<http://www.ia.omron.com/>

(c)Copyright OMRON Corporation 2008 All Right Reserved.



Компания «ЭлектроПласт» предлагает заключение долгосрочных отношений при поставках импортных электронных компонентов на взаимовыгодных условиях!

Наши преимущества:

- Оперативные поставки широкого спектра электронных компонентов отечественного и импортного производства напрямую от производителей и с крупнейших мировых складов;
- Поставка более 17-ти миллионов наименований электронных компонентов;
- Поставка сложных, дефицитных, либо снятых с производства позиций;
- Оперативные сроки поставки под заказ (от 5 рабочих дней);
- Экспресс доставка в любую точку России;
- Техническая поддержка проекта, помощь в подборе аналогов, поставка прототипов;
- Система менеджмента качества сертифицирована по Международному стандарту ISO 9001;
- Лицензия ФСБ на осуществление работ с использованием сведений, составляющих государственную тайну;
- Поставка специализированных компонентов (Xilinx, Altera, Analog Devices, Intersil, Interpoint, Microsemi, Aeroflex, Peregrine, Syfer, Eurofarad, Texas Instrument, Miteq, Cobham, E2V, MA-COM, Hittite, Mini-Circuits, General Dynamics и др.);

Помимо этого, одним из направлений компании «ЭлектроПласт» является направление «Источники питания». Мы предлагаем Вам помощь Конструкторского отдела:

- Подбор оптимального решения, техническое обоснование при выборе компонента;
- Подбор аналогов;
- Консультации по применению компонента;
- Поставка образцов и прототипов;
- Техническая поддержка проекта;
- Защита от снятия компонента с производства.



Как с нами связаться

Телефон: 8 (812) 309 58 32 (многоканальный)

Факс: 8 (812) 320-02-42

Электронная почта: org@eplast1.ru

Адрес: 198099, г. Санкт-Петербург, ул. Калинина, дом 2, корпус 4, литера А.