

### TYPICAL INDICATOR ORDERING EXAMPLE

**LB 01 G W01 — 5C 12 — JC**

**Shapes**

01	Square
02	Round
03	Rectangular

**Housing**

K	Black
G	Gray

**Terminals**

W01	Silver Solder Lug/ Quick Connect Terminals*
-----	---

**Lamps**

**Incandescent Lamp Used with Solid Cap**

05	5-volt
12	12-volt

**Incandescent or Neon Used with Insert Cap**

01	110-volt Neon
05	5-volt Incandescent
12	12-volt Incandescent

**Bright LED Used with LED Cap**

Colors		Resistor	
5C	Red	No Code	No Resistor
5D	Amber	05	5-volt
		12	12-volt
5F	Green	24	24-volt

**Super Bright LED Used with LED Cap**

6B	White
6F	Green
6G	Blue

**Cap Types & Colors**

**Solid Cap: Lens/Filter Colors**

BJ	White/Clear
CJ	Red/Clear
EJ	Yellow/Clear
FJ	Green/Clear
GJ	Blue/Clear

**Insert Cap: Lens/Filter Colors**

JB	Clear/White
JC	Clear/Red
JE	Clear/Yellow
*JF	Clear/Green
*JG	Clear/Blue

\*JF & JG not suitable with neon.

**LED Cap: Lens/Diffuser Colors**

JB	Clear/White
JC	Clear/Red
JD	Clear/Amber
JF	Clear/Green

**LED Cap: Lens/Diffuser Colors**

JB	Clear/White
----	-------------

\* Wire harness & cable assemblies offered only in Americas

### DESCRIPTION FOR TYPICAL ORDERING EXAMPLE

#### LB01GW01-5C12-JC



**SHAPES & PANEL CUTOUTS**

**01** .622" (15.8mm)  
Square



**02** .854" (21.7mm)  
Round

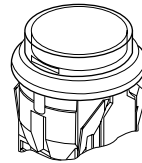

**03** .622" x .866" (15.8mm x 22.0mm)  
Rectangular



Panel Thickness: .039" ~ .157" (1.0 ~ 4.0mm)

**HOUSING**

Housing Colors Available:

**K** Black

**G** Gray

**TERMINALS**

**W01** Silver Solder Lug/.110" (2.8mm) Quick Connect



**LAMP CODES & SPECIFICATIONS**

**Incandescent Lamp for Solid Colored and Colored Insert Caps**

<b>AT607</b>   T-1 Bi-pin		<b>05</b>	<b>12</b>	
	Voltage	V	5V AC	12V AC
	Current	I	115mA	60mA
	Endurance	Hours	10,000 average	
	Ambient Temp. Range		-25°C ~ +50°C	

**Neon Lamp for Colored Insert Cap**

<b>AT607N</b>   T-1 Bi-pin		<b>01</b>	
	Voltage	V	110V AC
	Current	I	1.5mA
	Endurance	Hours	10,000 average
	Ambient Temp. Range		-25°C ~ +50°C
	Recommended Resistors: 33K ohms for 110V AC; 100K ohms for 220V AC		

The electrical specifications shown are determined at a basic temperature of 25°C.

### LED COLORS & SPECIFICATIONS

The electrical specifications shown are determined at a basic temperature of 25°C. Polarity marks are on the device.  
 If the source voltage exceeds the rated voltage, a ballast resistor is required.  
 The resistor value can be calculated by using the formula in the Supplement section.  
 Additional lamp detail is shown in the Accessories & Hardware section.

#### Bright LED without Resistor

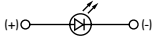
<b>AT635</b> LEDs are colored in OFF state.   T-1½ Bi-pin	Color Codes	Red <b>5C</b>	Amber <b>5D</b>	Green <b>5F</b>	<b>No Code</b> No Resistor	Red	Amber	Green
	Forward Peak Current	$I_{FM}$			30mA	30mA	30mA	
	Continuous Forward Current	$I_F$			20mA	20mA	20mA	
	Forward Voltage	$V_F$			1.9V	2.0V	2.1V	
	Reverse Peak Voltage	$V_{RM}$			5V	5V	5V	
	Current Reduction Rate Above 25°C	$\Delta I_F$			0.42mA/°C	0.42mA/°C	0.42mA/°C	
	Ambient Temperature Range				-25° ~ +50°C			

#### Bright LED with Resistor

<b>AT627 with Resistor</b>  T-1 Bi-pin	Color Codes:	Red <b>5C</b>	Amber <b>5D</b>	Green <b>5F</b>	Resistor Codes		
		<b>05</b>	<b>12</b>	<b>24</b>			
	Forward Peak Current	$I_{FM}$			—	—	—
	Continuous Forward Current	$I_F$			52mA	26mA	13mA
	Forward Voltage	$V_F$			5V	12V	24V
	Reverse Peak Voltage	$V_{RM}$			4V	8V	16V
	Current Reduction Rate Above 25°C	$\Delta I_F$			0.50mA/°C		
Ambient Temperature Range				-25° ~ +50°C			

AT627  
5-volt  
4-element  
with Resistor



AT627  
12-volt  
4-element  
with Resistor



AT627  
24-volt  
4-element  
with Resistor



#### Super Bright Single Element LED

<b>AT625G Blue</b> <b>AT631B White</b> <b>AT632F Green</b>   T-1 Bi-pin				<b>6B</b>	<b>6F</b>	<b>6G</b>
		Color	White	Green	Blue	
	Forward Peak Current	$I_{FM}$	30mA	30mA	30mA	
	Continuous Forward Current	$I_F$	20mA	20mA	20mA	
	Forward Voltage	$V_F$	3.6V	3.5V	3.6V	
	Reverse Peak Voltage	$V_{RM}$	5V	5V	5V	
	Current Reduction Rate Above 25°C	$\Delta I_F$	0.50mA/°C			
	Ambient Temperature Range		-25° ~ +50°C			

**CAP TYPES & COLOR COMBINATIONS**

Color Codes: B White C Red D Amber E Yellow F Green G Blue J Clear

**Solid Cap for Incandescent Lamp**

Lens/Filter  
Colors Available:

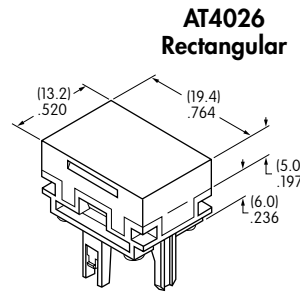

Material: Polycarbonate Finish: Glossy

**Insert Cap for Incandescent or Neon Lamp**

Lens/Filter  
Colors Available:

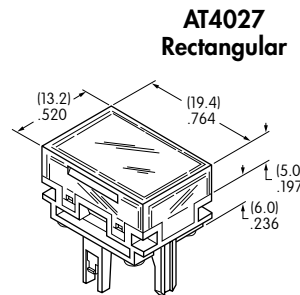

JF and JG not suitable with neon lamp.

Material: Polycarbonate Finish: Glossy

**Cap for Bright LED without Resistor**

Lens/Diffuser  
Colors Available:

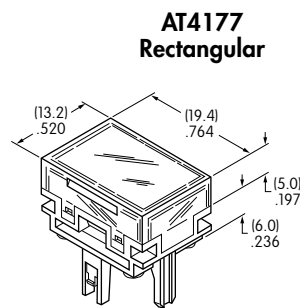

Material: Polycarbonate Finish: Glossy

**Cap for Bright LED with Resistor**

Lens/Diffuser  
Colors Available:

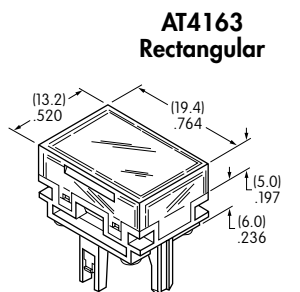
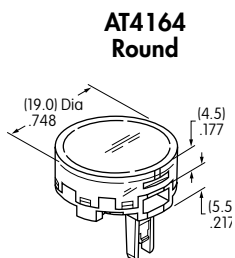

Material: Polycarbonate Finish: Glossy

### CAP TYPES & COLOR COMBINATIONS

#### Cap for Super Bright LEDs



Clear Lens  
White Diffuser

AT4129  
Square

AT4128  
Round

AT4130  
Rectangular

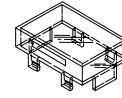

Transparent  
Clear Lens

Material:  
Polycarbonate  
Finish: Glossy

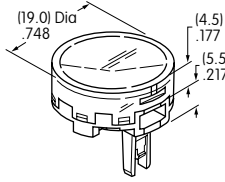
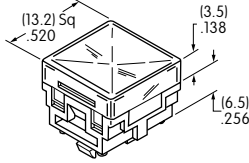

Translucent  
White Diffuser



LEDs AT625  
AT631 AT632

### TYPICAL INDICATOR DIMENSIONS

#### Square

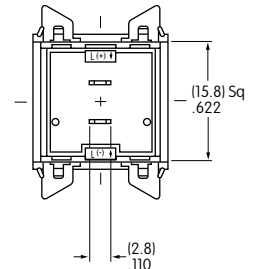
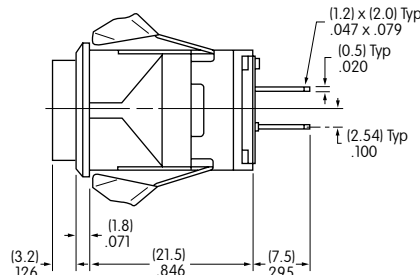
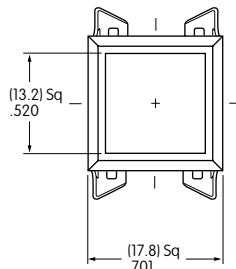

LB01KW01-12-CJ

#### Round

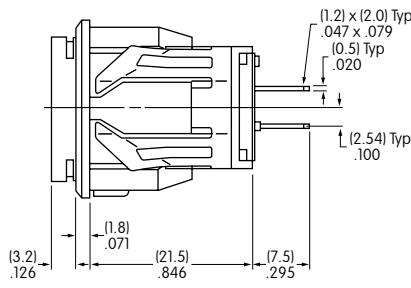
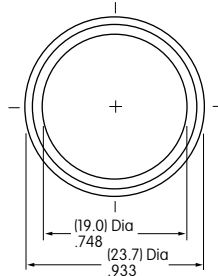

LB02KW01-12-CJ

#### Rectangular

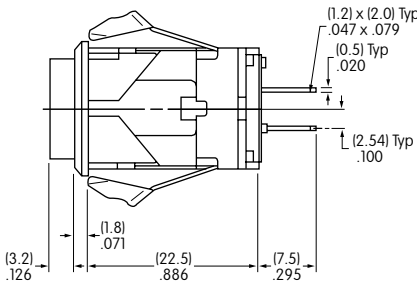
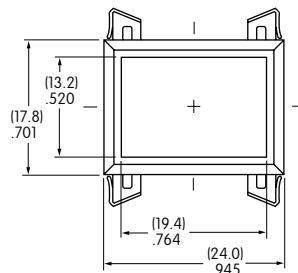

LB03KW01-12-CJ



Компания «ЭлектроПласт» предлагает заключение долгосрочных отношений при поставках импортных электронных компонентов на взаимовыгодных условиях!

Наши преимущества:

- Оперативные поставки широкого спектра электронных компонентов отечественного и импортного производства напрямую от производителей и с крупнейших мировых складов;
- Поставка более 17-ти миллионов наименований электронных компонентов;
- Поставка сложных, дефицитных, либо снятых с производства позиций;
- Оперативные сроки поставки под заказ (от 5 рабочих дней);
- Экспресс доставка в любую точку России;
- Техническая поддержка проекта, помощь в подборе аналогов, поставка прототипов;
- Система менеджмента качества сертифицирована по Международному стандарту ISO 9001;
- Лицензия ФСБ на осуществление работ с использованием сведений, составляющих государственную тайну;
- Поставка специализированных компонентов (Xilinx, Altera, Analog Devices, Intersil, Interpoint, Microsemi, Aeroflex, Peregrine, Syfer, Eurofarad, Texas Instrument, Miteq, Cobham, E2V, MA-COM, Hittite, Mini-Circuits, General Dynamics и др.);

Помимо этого, одним из направлений компании «ЭлектроПласт» является направление «Источники питания». Мы предлагаем Вам помощь Конструкторского отдела:

- Подбор оптимального решения, техническое обоснование при выборе компонента;
- Подбор аналогов;
- Консультации по применению компонента;
- Поставка образцов и прототипов;
- Техническая поддержка проекта;
- Защита от снятия компонента с производства.



#### Как с нами связаться

**Телефон:** 8 (812) 309 58 32 (многоканальный)

**Факс:** 8 (812) 320-02-42

**Электронная почта:** [org@eplast1.ru](mailto:org@eplast1.ru)

**Адрес:** 198099, г. Санкт-Петербург, ул. Калинина, дом 2, корпус 4, литера А.