

TYPICAL INDICATOR ORDERING EXAMPLE

LB 01 G W01 — 5C 12 — JC

Shapes

01	Square
02	Round
03	Rectangular

Housing

K	Black
G	Gray

Terminals

W01	Silver Solder Lug/ Quick Connect Terminals*
-----	---

Lamps

Incandescent Lamp Used with Solid Cap

05	5-volt
12	12-volt

Incandescent or Neon Used with Insert Cap

01	110-volt Neon
05	5-volt Incandescent
12	12-volt Incandescent

Bright LED Used with LED Cap

Colors		Resistor	
5C	Red	No Code	No Resistor
5D	Amber	05	5-volt
		12	12-volt
5F	Green	24	24-volt

Super Bright LED Used with LED Cap

6B	White
6F	Green
6G	Blue

Cap Types & Colors

Solid Cap: Lens/Filter Colors

BJ	White/Clear
CJ	Red/Clear
EJ	Yellow/Clear
FJ	Green/Clear
GJ	Blue/Clear

Insert Cap: Lens/Filter Colors

JB	Clear/White
JC	Clear/Red
JE	Clear/Yellow
*JF	Clear/Green
*JG	Clear/Blue

*JF & JG not suitable with neon.

LED Cap: Lens/Diffuser Colors

JB	Clear/White
JC	Clear/Red
JD	Clear/Amber
JF	Clear/Green

LED Cap: Lens/Diffuser Colors

JB	Clear/White
----	-------------

* Wire harness & cable assemblies offered only in Americas

DESCRIPTION FOR TYPICAL ORDERING EXAMPLE

LB01GW01-5C12-JC



SHAPES & PANEL CUTOUTS

01 .622" (15.8mm)
Square

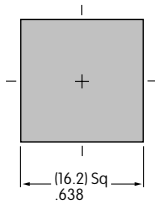
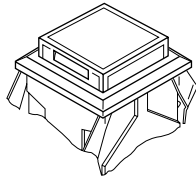

02 .854" (21.7mm)
Round

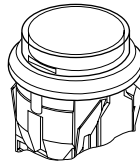

03 .622" x .866" (15.8mm x 22.0mm)
Rectangular

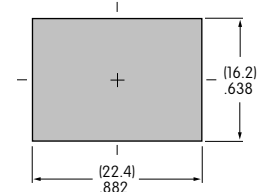

Panel Thickness: .039" ~ .157" (1.0 ~ 4.0mm)

HOUSING

Housing Colors Available:

K Black

G Gray

TERMINALS

W01 Silver Solder Lug/.110" (2.8mm) Quick Connect

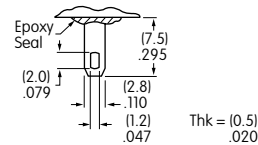

LAMP CODES & SPECIFICATIONS

Incandescent Lamp for Solid Colored and Colored Insert Caps

AT607  T-1 Bi-pin		05	12	
	Voltage	V	5V AC	12V AC
	Current	I	115mA	60mA
	Endurance	Hours	10,000 average	
	Ambient Temp. Range		-25°C ~ +50°C	

Neon Lamp for Colored Insert Cap

AT607N  T-1 Bi-pin		01	
	Voltage	V	110V AC
	Current	I	1.5mA
	Endurance	Hours	10,000 average
	Ambient Temp. Range		-25°C ~ +50°C
Recommended Resistors: 33K ohms for 110V AC; 100K ohms for 220V AC			

The electrical specifications shown are determined at a basic temperature of 25°C.

LED COLORS & SPECIFICATIONS

The electrical specifications shown are determined at a basic temperature of 25°C. Polarity marks are on the device.
 If the source voltage exceeds the rated voltage, a ballast resistor is required.
 The resistor value can be calculated by using the formula in the Supplement section.
 Additional lamp detail is shown in the Accessories & Hardware section.

Bright LED without Resistor

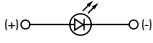
AT635 LEDs are colored in OFF state.   T-1½ Bi-pin	Color Codes	Red 5C	Amber 5D	Green 5F	No Code No Resistor
	Forward Peak Current	I_{FM}			Red: 30mA, Amber: 30mA, Green: 30mA
	Continuous Forward Current	I_F			Red: 20mA, Amber: 20mA, Green: 20mA
	Forward Voltage	V_F			Red: 1.9V, Amber: 2.0V, Green: 2.1V
	Reverse Peak Voltage	V_{RM}			Red: 5V, Amber: 5V, Green: 5V
	Current Reduction Rate Above 25°C	ΔI_F			Red: 0.42mA/°C, Amber: 0.42mA/°C, Green: 0.42mA/°C
	Ambient Temperature Range				-25° ~ +50°C

Bright LED with Resistor

AT627 with Resistor  T-1 Bi-pin	Color Codes:	Red 5C	Amber 5D	Green 5F	Resistor Codes		
	Forward Peak Current	I_{FM}			Red: 05 , Amber: 12 , Green: 24		
	Continuous Forward Current	I_F			Red: 52mA, Amber: 26mA, Green: 13mA		
	Forward Voltage	V_F			Red: 5V, Amber: 12V, Green: 24V		
	Reverse Peak Voltage	V_{RM}			Red: 4V, Amber: 8V, Green: 16V		
	Current Reduction Rate Above 25°C	ΔI_F			0.50mA/°C		
	Ambient Temperature Range				-25° ~ +50°C		

AT627
5-volt
4-element
with Resistor

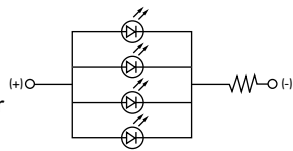

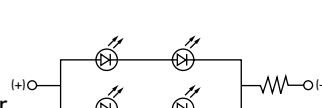

AT627
12-volt
4-element
with Resistor

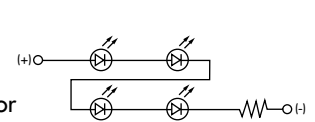

AT627
24-volt
4-element
with Resistor



Super Bright Single Element LED

AT625G Blue AT631B White AT632F Green   T-1 Bi-pin				Color	White	Green	Blue
	Forward Peak Current	I_{FM}			White: 6B , Green: 6F , Blue: 6G		
	Continuous Forward Current	I_F			White: 30mA, Green: 30mA, Blue: 30mA		
	Forward Voltage	V_F			White: 3.6V, Green: 3.5V, Blue: 3.6V		
	Reverse Peak Voltage	V_{RM}			White: 5V, Green: 5V, Blue: 5V		
	Current Reduction Rate Above 25°C	ΔI_F			0.50mA/°C		
	Ambient Temperature Range				-25° ~ +50°C		

CAP TYPES & COLOR COMBINATIONS

Color Codes: B White C Red D Amber E Yellow F Green G Blue J Clear

Solid Cap for Incandescent Lamp

Lens/Filter
Colors Available:

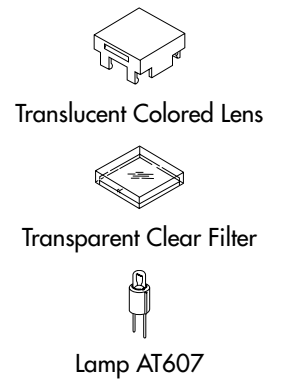
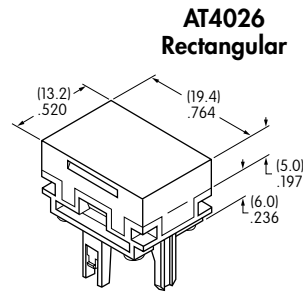
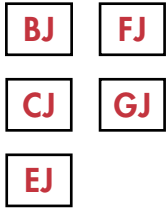

Material: Polycarbonate Finish: Glossy

Insert Cap for Incandescent or Neon Lamp

Lens/Filter
Colors Available:

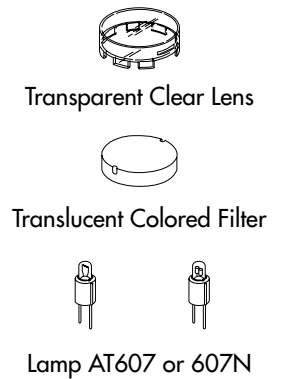
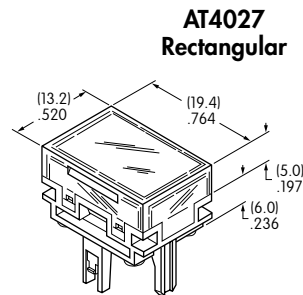
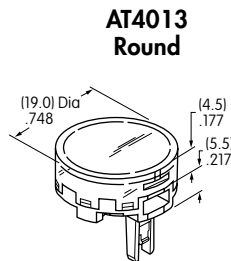
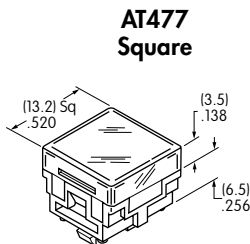
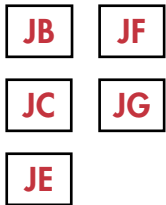

JF and JG not suitable with neon lamp.

Material: Polycarbonate Finish: Glossy

Cap for Bright LED without Resistor

Lens/Diffuser
Colors Available:

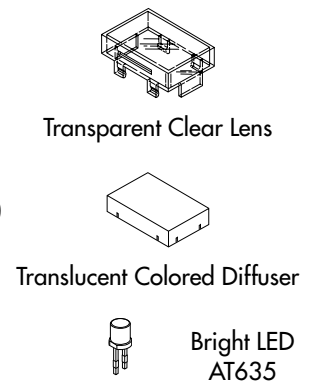
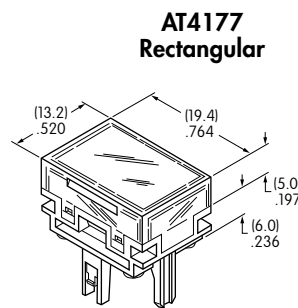
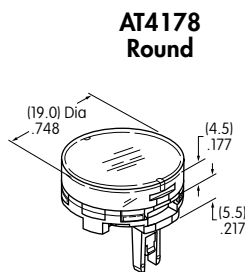
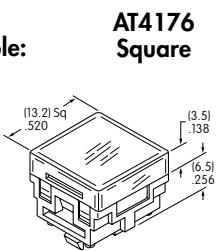

Material: Polycarbonate Finish: Glossy

Cap for Bright LED with Resistor

Lens/Diffuser
Colors Available:

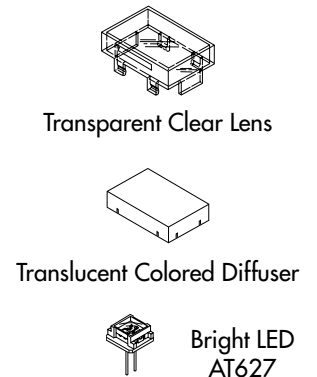
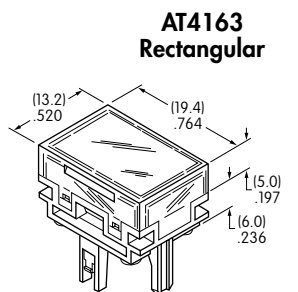
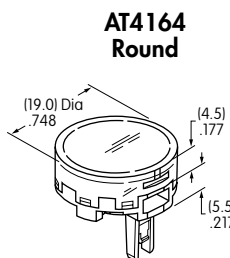
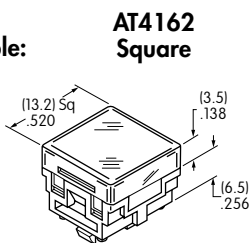

Material: Polycarbonate Finish: Glossy

Toggle
Rockers
Pushbuttons
Illuminated PB
Programmable
Keylocks
Rotaries
Slides
Tactiles
Tilt
Touch
Indicators
Accessories
Supplement

CAP TYPES & COLOR COMBINATIONS

Cap for Super Bright LEDs



Clear Lens
White Diffuser

AT4129
Square

AT4128
Round

AT4130
Rectangular



Transparent
Clear Lens

Material:
Polycarbonate
Finish: Glossy

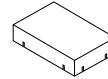
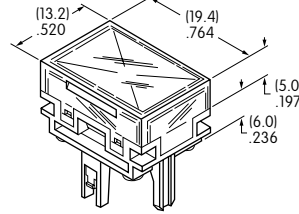
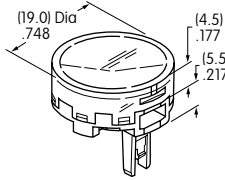
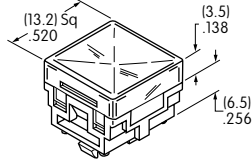

Translucent
White Diffuser



LEDs AT625
AT631 AT632

TYPICAL INDICATOR DIMENSIONS

Square

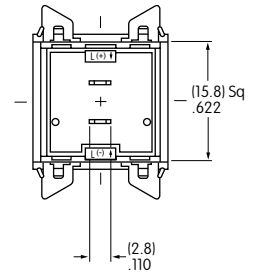
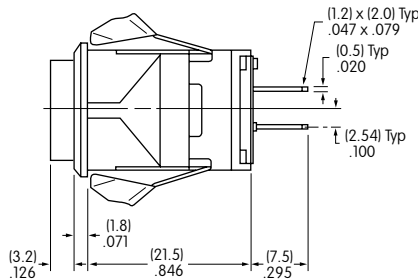
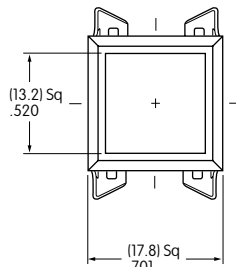

LB01KW01-12-CJ

Round

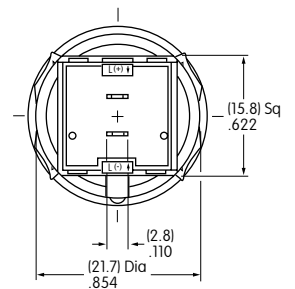
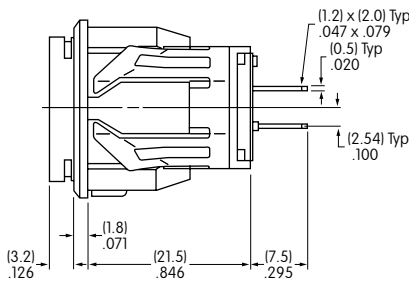
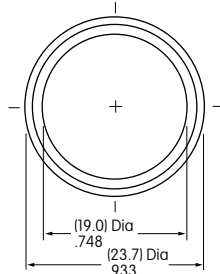

LB02KW01-12-CJ

Rectangular

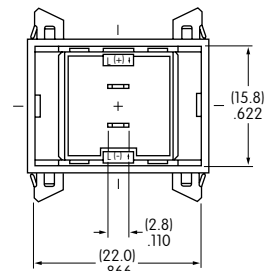
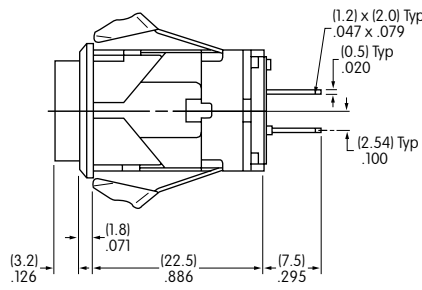
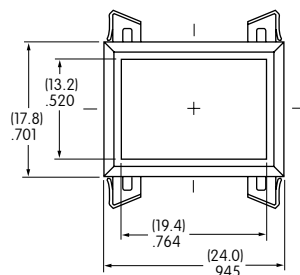

LB03KW01-12-CJ



Компания «ЭлектроПласт» предлагает заключение долгосрочных отношений при поставках импортных электронных компонентов на взаимовыгодных условиях!

Наши преимущества:

- Оперативные поставки широкого спектра электронных компонентов отечественного и импортного производства напрямую от производителей и с крупнейших мировых складов;
- Поставка более 17-ти миллионов наименований электронных компонентов;
- Поставка сложных, дефицитных, либо снятых с производства позиций;
- Оперативные сроки поставки под заказ (от 5 рабочих дней);
- Экспресс доставка в любую точку России;
- Техническая поддержка проекта, помощь в подборе аналогов, поставка прототипов;
- Система менеджмента качества сертифицирована по Международному стандарту ISO 9001;
- Лицензия ФСБ на осуществление работ с использованием сведений, составляющих государственную тайну;
- Поставка специализированных компонентов (Xilinx, Altera, Analog Devices, Intersil, Interpoint, Microsemi, Aeroflex, Peregrine, Syfer, Eurofarad, Texas Instrument, Miteq, Cobham, E2V, MA-COM, Hittite, Mini-Circuits, General Dynamics и др.);

Помимо этого, одним из направлений компании «ЭлектроПласт» является направление «Источники питания». Мы предлагаем Вам помощь Конструкторского отдела:

- Подбор оптимального решения, техническое обоснование при выборе компонента;
- Подбор аналогов;
- Консультации по применению компонента;
- Поставка образцов и прототипов;
- Техническая поддержка проекта;
- Защита от снятия компонента с производства.



Как с нами связаться

Телефон: 8 (812) 309 58 32 (многоканальный)

Факс: 8 (812) 320-02-42

Электронная почта: org@eplast1.ru

Адрес: 198099, г. Санкт-Петербург, ул. Калинина, дом 2, корпус 4, литера А.