



### »» Features

- High power 40A automotive relay.
- USA & European footprint are both available.
- Open frame, dust cover, flux-free type, and sealed washable type are available.
- Offering SPNC, SPNO, SPDT of contact configurations.

### »» Type List

#### ◆ Standard type

Terminal style	Contact form	Designation (enclosure)			
		Open type	Flux tight	Sealed type	Sealed type washable
PCB terminal (Footprint for European)	1A (SPNO)	822E-1A	822E-1A-C	822E-1A-V	822E-1A-S
	1B (SPNC)	822E-1B	822E-1B-C	822E-1B-V	822E-1B-S
	1C (SPDT)	822E-1C	822E-1C-C	822E-1C-V	822E-1C-S
PCB terminal (Footprint for USA)	1A (SPNO)	822U-1A	822U-1A-C	822U-1A-V	822U-1A-S
	1B (SPNC)	822U-1B	822U-1B-C	822U-1B-V	822U-1B-S
	1C (SPDT)	822U-1C	822U-1C-C	822U-1C-V	822U-1C-S
PCB terminal (Footprint for USA different terminal)	1A (SPNO)	-----	822UA-1A-C	822UA-1A-V	822UA-1A-S
	1B (SPNC)		822UA-1B-C	822UA-1B-V	822UA-1B-S
	1C (SPDT)		822UA-1C-C	822UA-1C-V	822UA-1C-S

#### ◆ High sensitivity type

PCB terminal (Footprint for European)	1A (SPNO)	822EN-1A	822EN-1A-C	822EN-1A-V	822EN-1A-S
	1B (SPNC)	822EN-1B	822EN-1B-C	822EN-1B-V	822EN-1B-S
	1C (SPDT)	822EN-1C	822EN-1C-C	822EN-1C-V	822EN-1C-S
PCB terminal (Footprint for USA)	1A (SPNO)	822UN-1A	822UN-1A-C	822UN-1A-V	822UN-1A-S
	1B (SPNC)	822UN-1B	822UN-1B-C	822UN-1B-V	822UN-1B-S
	1C (SPDT)	822UN-1C	822UN-1C-C	822UN-1C-V	822UN-1C-S
PCB terminal (Footprint for USA different terminal)	1A (SPNO)	-----	822UAN-1A-C	822UAN-1A-V	822UAN-1A-S
	1B (SPNC)		822UAN-1B-C	822UAN-1B-V	822UAN-1B-S
	1C (SPDT)		822UAN-1C-C	822UAN-1C-V	822UAN-1C-S

### »» Ordering Information

822      E          N      -      1C      -      C  
 1          2          3          4          5

- |   |   |
|---|---|
| 1. 822 -- Basic series designation<br>2. E -- Europe footprint<br>U -- USA footprint<br>UA -- USA different terminal<br>3. Blank -- standard type<br>N -- High sensitivity type | 4. 1A -- Single pole normally open<br>1B -- Single pole normally close<br>1C -- Single pole double throw<br>5. Blank -- Open type<br>C -- Flux tight<br>V -- Sealed type<br>S -- Sealed type washable |
|---|---|

### »» Contact Rating

Resistive load	1A	1B	1C
		40A 14VDC	30A 14VDC

## »» Coil Rating (DC)

## ◆ Standard type

Rated voltage (V)	Rated current $\pm 10\%$ at 23 °C (mA)	Coil resistance $\pm 10\%$ at 23 °C ( $\Omega$ )	Max. continuous voltage at 85 °C <sup>(1)</sup>	Pick up voltage(Max) at 23 °C	Drop out voltage(Min) at 23 °C	Power consumption at rated voltage
6	315	19	130 % of rated Voltage	3.3	0.6	approx. 1.6W
9	180	50		5.0	0.9	
12	133	90		6.8	1.2	
24	66	362		13.9	2.4	

Note:(1)Continuous contact current at 20A.

## ◆ High sensitivity type

Rated voltage (V)	Rated current $\pm 10\%$ at 23 °C (mA)	Coil resistance $\pm 10\%$ at 23 °C ( $\Omega$ )	Max. continuous voltage at 85 °C <sup>(1)</sup>	Pick up voltage(Max) at 23 °C	Drop out voltage(Min) at 23 °C	Power consumption at rated voltage
6	200	30	130 % of rated Voltage	75 % of rated Voltage	10 % of rated Voltage	approx. 1.2W
9	133	67.5				
12	100	120				
24	50	480				

Note:(1)Continuous contact current at 20A.

## »» Specification

Contact material	AgSnO alloy	
Contact voltage drop <sup>(1)</sup>	Typ. 40mV at 10A	
Insulation resistance <sup>(1)</sup>	50M $\Omega$ Min. (DC 500V)	
Operate time <sup>(1)</sup>	5ms Max.	
Release time <sup>(1)</sup>	4ms Max.	
Dielectric strength <sup>(1)</sup>	Between open contact	: AC 500V , 50/60Hz 1 min.
	Between contact and coil	: AC 500V , 50/60Hz 1 min.
Vibration resistance	10~55Hz , amplitude 1.5 mm	
Shock resistance	20G , 11ms , half sine wave pulse	
Life expectancy	Mechanical	10,000,000 operations (frequency 18,000 operations/hr)
	Electrical	100,000 operations (frequency 1,200 operations/hr)
Operating ambient temperature	-40~+85 °C (no freezing)	
Storage temperature	-40~+130 °C	
Weight	Approx. 17.5g	

Note : (1) initial value

## »» Outline Dimensions

### ◆ 822E,UA

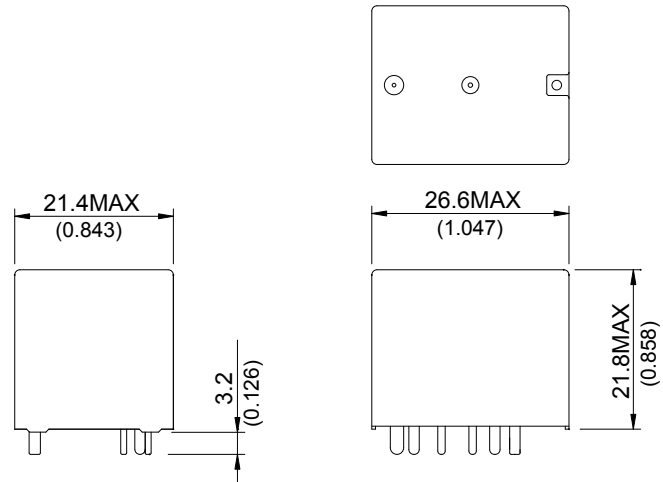

### ◆ 822E OPEN

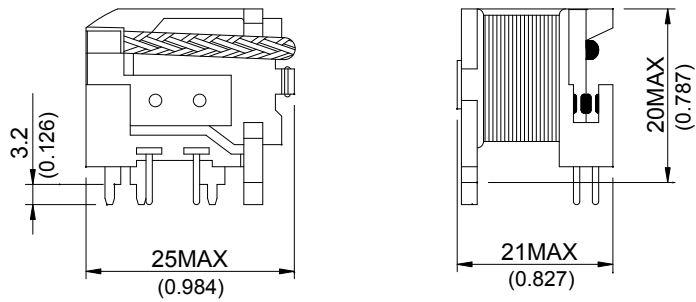

### ◆ 822U

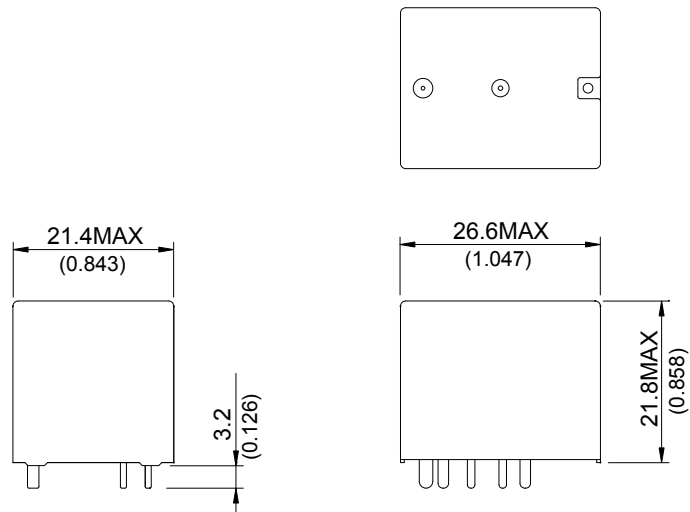

### ◆ 822U OPEN

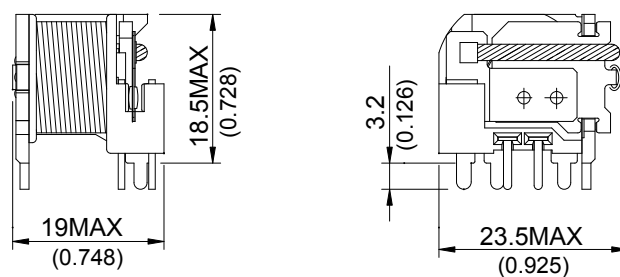

# 822

## »» Wiring Diagram

BOTTOM VIEW

◆ 822E, 822UA, 822U (OPEN)

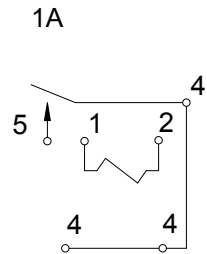
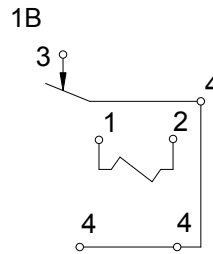
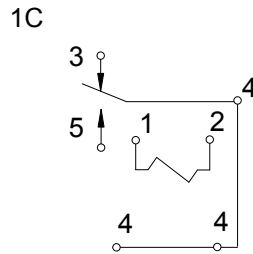

◆ 822U

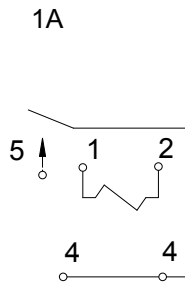
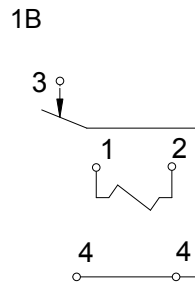
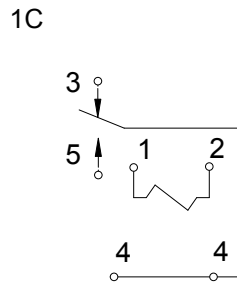

## »» PC Board Layout

BOTTOM VIEW

◆ 822E



◆ 822E (OPEN)

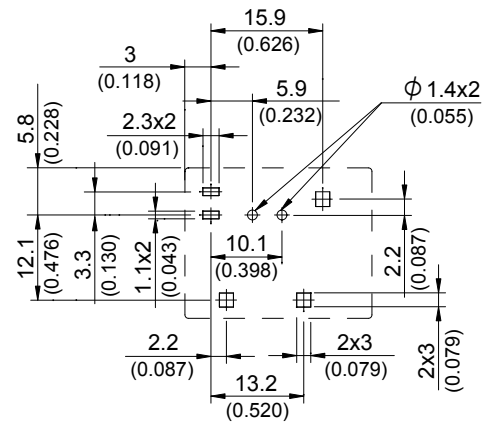

◆ 822U

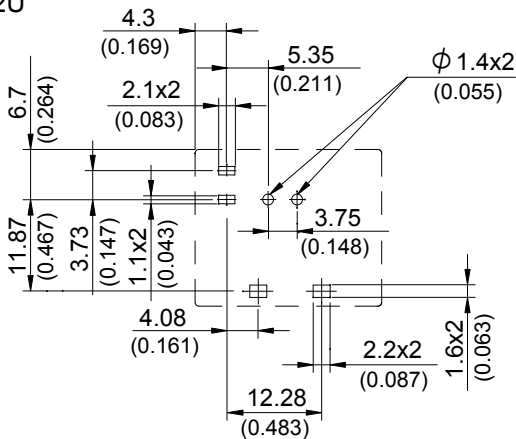

◆ 822U (OPEN)

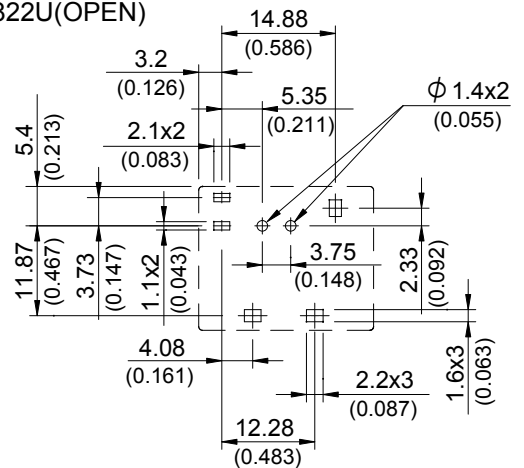

◆ 822UA

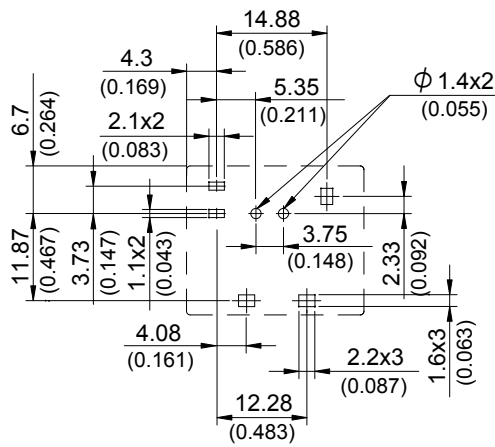

»» Engineering Data

Safe breaking, arc extinguished  
(normally open contact) for resistive loads.

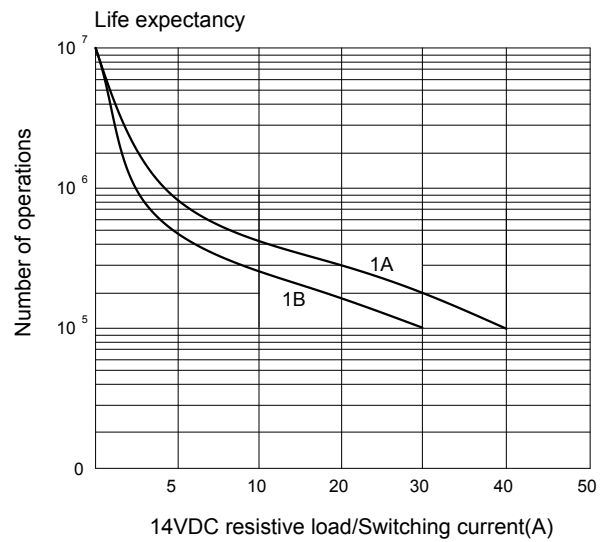

Ambient temperature vs coil voltage for continuous duty



A:10A B:20A C:30A D:40A Contact load(resistive)

Maximum mean coil temperature=155°C

Operate time/Release time

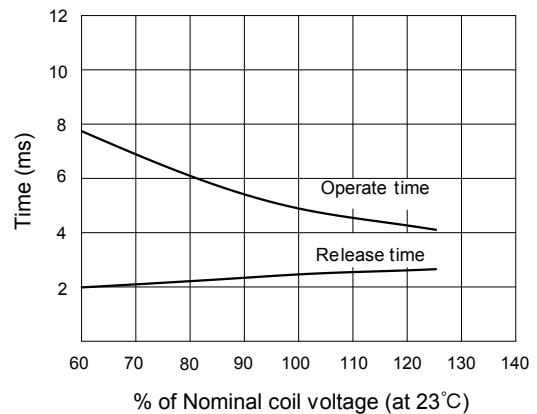



Компания «ЭлектроПласт» предлагает заключение долгосрочных отношений при поставках импортных электронных компонентов на взаимовыгодных условиях!

Наши преимущества:

- Оперативные поставки широкого спектра электронных компонентов отечественного и импортного производства напрямую от производителей и с крупнейших мировых складов;
- Поставка более 17-ти миллионов наименований электронных компонентов;
- Поставка сложных, дефицитных, либо снятых с производства позиций;
- Оперативные сроки поставки под заказ (от 5 рабочих дней);
- Экспресс доставка в любую точку России;
- Техническая поддержка проекта, помощь в подборе аналогов, поставка прототипов;
- Система менеджмента качества сертифицирована по Международному стандарту ISO 9001;
- Лицензия ФСБ на осуществление работ с использованием сведений, составляющих государственную тайну;
- Поставка специализированных компонентов (Xilinx, Altera, Analog Devices, Intersil, Interpoint, Microsemi, Aeroflex, Peregrine, Syfer, Eurofarad, Texas Instrument, Miteq, Cobham, E2V, MA-COM, Hittite, Mini-Circuits, General Dynamics и др.);

Помимо этого, одним из направлений компании «ЭлектроПласт» является направление «Источники питания». Мы предлагаем Вам помощь Конструкторского отдела:

- Подбор оптимального решения, техническое обоснование при выборе компонента;
- Подбор аналогов;
- Консультации по применению компонента;
- Поставка образцов и прототипов;
- Техническая поддержка проекта;
- Защита от снятия компонента с производства.



#### Как с нами связаться

**Телефон:** 8 (812) 309 58 32 (многоканальный)

**Факс:** 8 (812) 320-02-42

**Электронная почта:** [org@eplast1.ru](mailto:org@eplast1.ru)

**Адрес:** 198099, г. Санкт-Петербург, ул. Калинина, дом 2, корпус 4, литера А.